



THE DATASHEET OF AK8151AU





1.8V/3.3V Single-PLL Clock Generator AK8151A

Features

- **Input Frequency:**
27 MHz (1.8V or 3.3V)
- **PLL Output Frequency:**
Selectable by SEL pin setting
60 MHz or 72 MHz (1.8V or 3.3V)
- **Low Jitter Performance:**
Period (1σ): 25 ps typ.
- **Low Current Consumption:**
VDDO1 = 3.3V, VDDO2=1.8V, No load
11 mW Typ. (CLKOUT=60MHz)
13 mW Typ. (CLKOUT=72MHz)
- **Output Load:**
15 pF Max
- **Supply Voltage:**
VDD : 1.7-1.9 V
VDDO1, 2: 1.7-1.9 V or 2.7V-3.6V
- **Operating Temperature Range:**
-20 to +85°C
- **Package:**
8-pin USON (2.0mm x 2.0mm)

Description

The AK8151A is a single-PLL clock generator IC with two outputs. The high performance PLL locks to the master clock input, generating a low jitter, highly accurate clock output without an external crystal.

The integrated PLL generates 60MHz or 72MHz with 27 MHz input clock. The output frequency is selectable by SEL pin.

The AK8151A has two kinds of voltage supply pins. One is for the core and the other is for each of the two output buffers. The core requires 1.8V supply and the output buffers require 1.7V - 1.9V or 2.7V - 3.6V supply. Not only the output but also the input accepts 1.8V or 3.3V input clock from Crystal Oscillator.

Applications

- Digital Still Camera
- Digital Video Camera

Block Diagram

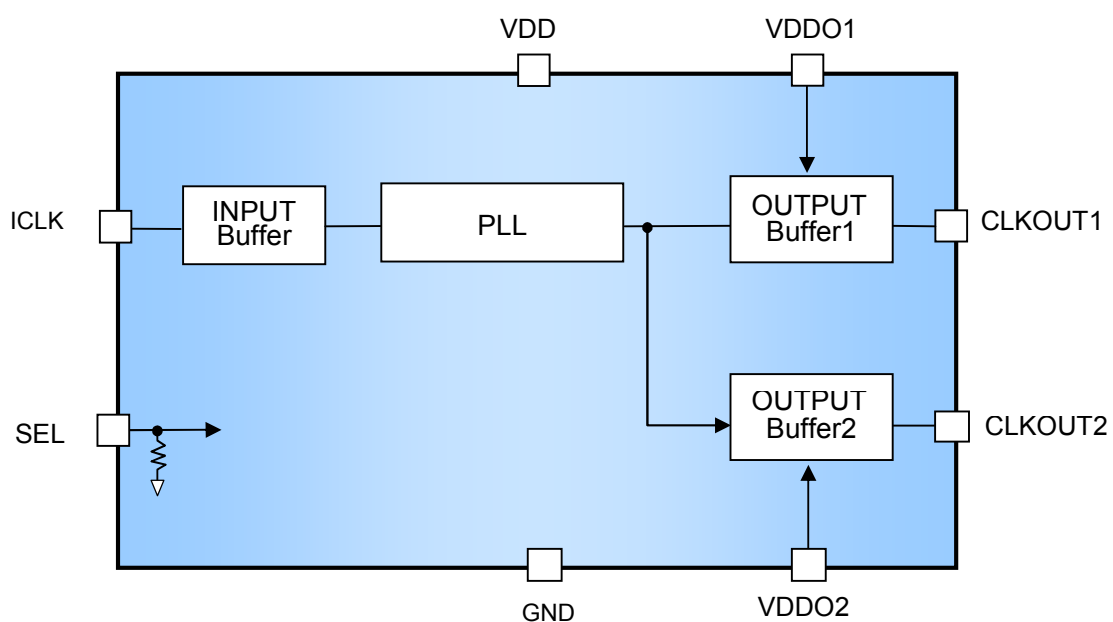

AK8151A Single PLL with Two Outputs Clock Generator

PIN DESCRIPTION

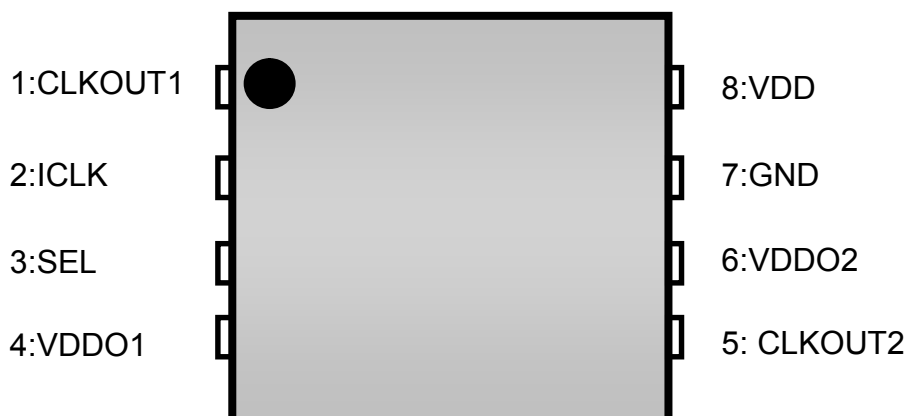

Package: 8-Pin USON (Top View)

Pin No.	Pin Name	Pin Type	Description	
1	CLKOUT1	OUT	60MHz or 72MHz output. One of which is selected by SEL pin.	
2	ICLK	IN	27 MHz input. 1.8V or 3.3V available.	
3	SEL	IN	Select pin for Output Frequency (CLKOUT1 and CLKOUT2). 1.8V or 3.3V available. "L" : 60MHz "H" : 72MHz	(1)
4	VDDO2	--	Power supply of Output Buffer for CLKOUT2.	
5	CLKOUT2	OUT	60MHz or 72MHz output. One of which is selected by SEL pin.	
6	VDDO1	--	Power supply of Output Buffer for CLKOUT1.	
7	VSS	--	Ground	
8	VDD	--	Power supply	

(1) Internal pull down 200kΩ (Typ.)

Ordering Information

Part Number	Marking	Shipping Packaging	Package	Temperature Range
AK8151AU	151A	Tape and Reel	8-pin USON	-20 to 85 °C

Absolute Maximum Rating

Over operating free-air temperature range unless otherwise noted ⁽¹⁾

Items	Symbol	Ratings	Unit
Supply Voltage	VDD	-0.3 to 4.6	V
Input Voltage	V _{in}	VSS-0.3 to 3.6	V
Input Current (any pins except supplies)	I _{IN}	±10	mA
Storage Temperature	T _{stg}	-55 to 130	°C

Note

(1) Stress beyond those listed under “Absolute Maximum Ratings” may cause permanent damage to the device. These are stress ratings only. Functional operation of the device at these or any other conditions beyond those indicated under “Recommended Operating Conditions” is not implied. Exposure to absolute-maximum-rating conditions for extended periods may affect device reliability. Electrical parameters are guaranteed only over the recommended operating temperature range.



ESD Sensitive Device

This device is manufactured on a CMOS process, therefore, generically susceptible to damage by excessive static voltage. Failure to observe proper handling and installation procedures can cause damage. AKM recommends that this device is handled with appropriate precautions.

Recommended Operation Conditions

Parameter	Symbol	Conditions	Min	Typ	Max	Unit
Operating Temperature	T _a		-20		85	°C
Supply Voltage 1	VDD		1.7	1.8	1.9	V
Supply Voltage 2	VDDO1	1.8V output	1.7	1.8	1.9	V
	VDDO2	3.3V output	2.7	3.3	3.6	
Input Clock Frequency	F _{in}			27.0		MHz
Input Clock Duty Cycle			30		70	%
Output Load Capacitance	C _p	Pin: CLKOUT1,2			15	pF

DC Characteristics

All specifications at VDD: 1.7 to 1.9V, VDDO1,2: 1.7 to 1.9V or 2.7 to 3.6V, Ta: -20 to +85°C, unless otherwise noted

Parameter	Symbol	Conditions	Min	Typ	Max	Unit
High level input voltage	V_{IH}	Pin: ICLK	0.7*VDDI			V
Low level input voltage	V_{IL}	VDDI: 1.7-1.9V or 2.7-3.6V			0.2*VDDI	
High level input voltage	V_{IH}	Pin: SEL	0.7*VDDI			V
Low level input voltage	V_{IL}	VDDI: 1.7-1.9V or 2.7-3.6V			0.3*VDDI	
Input leakage current 1	I_{L1}	Pin: ICLK	-10		+10	μ A
Input leakage current 2	I_{L2}	Pin: SEL	-10		+40	μ A
High level output voltage	V_{OH}	12M IOH= -5mA	0.8*VDDO1 0.8*VDDO2			V
Low level output voltage	V_{OL}	12M IOH= +5mA			0.2*VDDO1 0.2*VDDO2	V
Power Consumption	VDDO2=1.8V, VDD=1.8V, VDDO1 = 3.3V, No load					
	W1	60MHz output		11		mW
	W2	72MHz output		13		
	VDDO2=3.3V, VDD=1.8V, VDDO1 = 3.3V, No load					
	W3	60MHz output		16		mW
	W4	72MHz output		19		

VDDI: Power Supply for Input clock generator such as Crystal Oscillator.

AC Characteristics

All specifications at VDD: 1.7 to 1.9V, VDDO1,2: 1.7 to 1.9V or 2.7 to 3.6V, Ta: -20 to +85°C, unless otherwise noted

Parameter	Symbol	Conditions	MIN	TYP	MAX	Unit
Output Clock Frequency	f_o	Pin: CLKOUT1, 2 SEL=L		60		MHz
		Pin: CLKOUT1, 2 SEL=H		72		MHz
Output Clock Duty Cycle ⁽²⁾⁽³⁾		Pin: CLKOUT1, 2	45	50	55	%
Output Clock Rise Time ⁽²⁾⁽³⁾	t_{rise}	Pin: CLKOUT1, 2 0.2VDD to 0.8VDD			3.0	ns
Output Clock Fall Time ⁽²⁾⁽³⁾	t_{fall}	Pin: CLKOUT1, 2 0.2VDD to 0.8VDD			3.0	ns
Period Jitter ⁽²⁾⁽³⁾	Jit	Pin: CLKOUT1, 2 1 σ		25		ps
Output Lock Time ⁽¹⁾⁽³⁾	t_{lock}	Pin: CLKOUT1, 2 Power-up			3	ms

- (1) The time that output reaches the target frequency within accuracy of $\pm 0.1\%$ from the point that the power supply reaches VDD
- (2) With the load capacitance specified by the recommended operation conditions
- (3) Design value

Package Information

- Mechanical data (Units:mm)

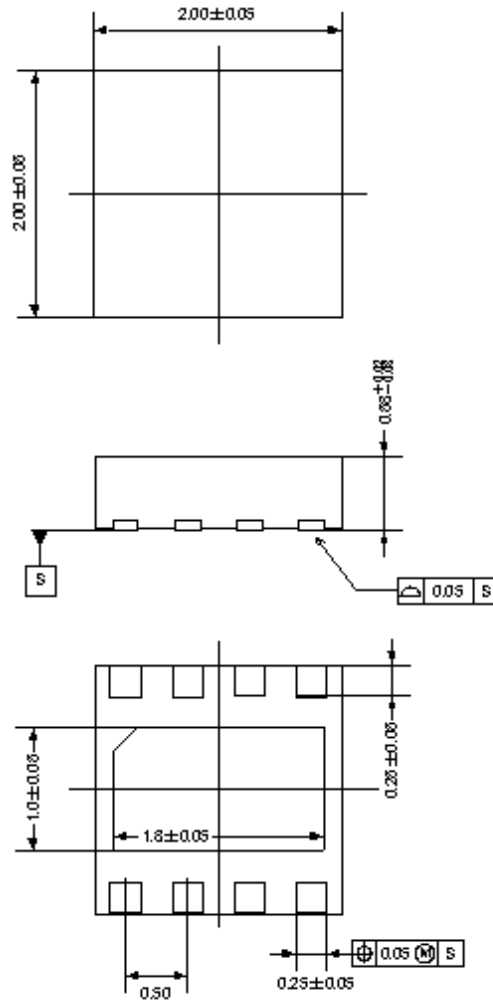

- Marking

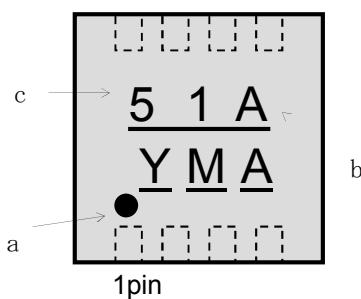

- a: #1 Pin Index
- b: Part number
- c: Date code (3 digits)

AKM and the logo - - are the brand of AKM's IC's and identify that AKM continues to offer the best choice for high performance mixed-signal solution under this brand.

• RoHS Compliance

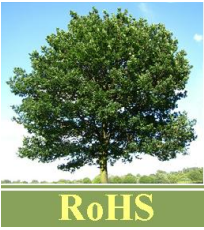

All integrated circuits from Asahi Kasei Microdevices Corporation (AKM) assembled in “lead-free” packages* are fully compliant with RoHS.



(*) RoHS compliant products from AKM are identified with “Pb free” letter indication on product label posted on the anti-shield bag and boxes.

IMPORTANT NOTICE

- These products and their specifications are subject to change without notice.
When you consider any use or application of these products, please make inquiries the sales office of Asahi Kasei Microdevices Corporation (AKM) or authorized distributors as to current status of the products.
- Descriptions of external circuits, application circuits, software and other related information contained in this document are provided only to illustrate the operation and application examples of the semiconductor products. You are fully responsible for the incorporation of these external circuits, application circuits, software and other related information in the design of your equipments. AKM assumes no responsibility for any losses incurred by you or third parties arising from the use of these information herein. AKM assumes no liability for infringement of any patent, intellectual property, or other rights in the application or use of such information contained herein.
- Any export of these products, or devices or systems containing them, may require an export license or other official approval under the law and regulations of the country of export pertaining to customs and tariffs, currency exchange, or strategic materials.
- AKM products are neither intended nor authorized for use as critical components^{Note1)} in any safety, life support, or other hazard related device or system^{Note2)}, and AKM assumes no responsibility for such use, except for the use approved with the express written consent by Representative Director of AKM. As used here:
 - Note1) A critical component is one whose failure to function or perform may reasonably be expected to result, whether directly or indirectly, in the loss of the safety or effectiveness of the device or system containing it, and which must therefore meet very high standards of performance and reliability.
 - Note2) A hazard related device or system is one designed or intended for life support or maintenance of safety or for applications in medicine, aerospace, nuclear energy, or other fields, in which its failure to function or perform may reasonably be expected to result in loss of life or in significant injury or damage to person or property.
- It is the responsibility of the buyer or distributor of AKM products, who distributes, disposes of, or otherwise places the product with a third party, to notify such third party in advance of the above content and conditions, and the buyer or distributor agrees to assume any and all responsibility and liability for and hold AKM harmless from any and all claims arising from the use of said product in the absence of such notification.

Looking for pricing, stock, or lifecycle information?

Click below to explore more details on WIN SOURCE:

-  [View AK8151AU on WIN SOURCE](#)
-  [Asahi Kasei Microsystems Information](#)

Optimize Your Supply Chain with WIN SOURCE Solutions

-  Global Sourcing Solution
-  Obsolete Management
-  Cost Control Management
-  Shortage Management
-  Alternative Solution
-  Excess Inventory Management