



**THE DATASHEET OF  
ADP5090-2-EVALZ**



## Evaluation Board for the **ADP5090** Demonstration Platform for Energy Harvesting

### FEATURES

- Plug and play energy harvesting platform**
- Compatible with Analog Devices, Inc., wireless sensor network (WSN) platform**
- Solar panel harvester included**
- RoHS compliant**

### GENERAL DESCRIPTION

The **ADP5090** demonstration platform is a plug and play evaluation board (**ADP5090-2-EVALZ**) for energy harvesting. The demonstration platform includes the photovoltaic (PV) panel and all of the power management to enable devices to be powered using energy harvesting. It is based on the Alta Devices™ PV cell, or the IXYS™ Corporation PV cell, and the **ADP5090** energy harvesting power management IC.

The **ADP5090** demonstration platform converts light energy to electrical energy. The PV panel converts the light to 0.8 V electrical energy. The **ADP5090** boosts the input voltage from 0.8 V to 3.5 V and stores the energy in a supercapacitor.

In addition, there is an on-board, low dropout (LDO) regulator that powers loads at lower voltage rails than the 3.5 V stored in the supercapacitor. The Alta Devices PV cell is a light harvesting gallium arsenide-based cell. The PV cell is optimized for indoor environments, where lux levels are typically 200 lux to 1000 lux.

The **ADP5090** is an ultra low power, synchronous, boost dc-to-dc regulator. The **ADP5090** runs from input voltages of 0.38 V to 3.3 V and provides a high efficiency solution with an integrated power switch, synchronous rectifier, and battery management. The demo platform provides an easy way to evaluate the device.

Full details about the **ADP5090** devices are available in the **ADP5090** data sheet and must be consulted when using the **ADP5090-2-EVALZ** evaluation board.

The demo platform system also plugs directly into the Analog Devices **WSN** demo platform.

This user guide describes how to set up the **ADP5090-2-EVALZ** board and how to use it for powering loads.

### SYSTEM BLOCK DIAGRAM

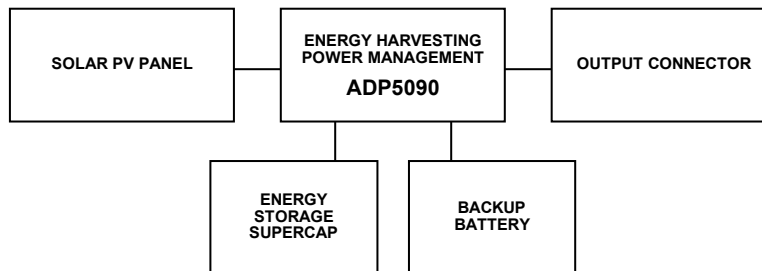

Figure 1.

12839-001

**TABLE OF CONTENTS**

Features ..... 1  
 General Description ..... 1  
 System Block Diagram ..... 1  
 Revision History ..... 2  
 Demonstration Board Quick Start Guide ..... 3  
 Evaluation Board Hardware ..... 4

Power Management of the Output (LDO).....4  
 J4 Output Connector .....5  
 Evaluation Board Schematic and Artwork.....6  
 Bill Of Materials.....8

**REVISION HISTORY**

**9/2019—Rev. 0 to Rev. A**

Changes to General Description ..... 1  
 Changes to Demonstration Board Quick Start Guide Section,  
 Figure 2, and Figure 3..... 3  
 Deleted Evaluation Board Layout Section..... 4  
 Changes to Power Management of the Output (LDO) Section  
 and Table 1 ..... 4  
 Changes to Figure 9 ..... 5  
 Changed Evaluation Board Schematic Section to Evaluation  
 Board Schematic and Artwork Section ..... 6

Moved Evaluation Board Schematic and Artwork Section and  
 Figure 10; Renumbered Sequentially .....6  
 Changes to Figure 10.....6  
 Moved Figure 11 and Figure 12 .....7  
 Changes to Figure 11.....7  
 Changes to Table 3.....8

**1/2015—Revision 0: Initial Version**

## DEMONSTRATION BOARD QUICK START GUIDE

This section explains how to connect the solar panel to the evaluation board and how to configure the evaluation board to start up and run.

1. Connect the 10-pin connector on the solar panel to the J3 10-pin connector on the [ADP5090-2-EVALZ](#) as shown in Figure 2.



Figure 2. [ADP5090-2-EVALZ](#) Board Hardware

2. Connect the J2\_1 and J2\_2, J2\_9 and J2\_10, and J2\_11 and J2\_12 jumper pairs together on the [ADP5090-2-EVALZ](#) board, as shown in Figure 3.
3. Place the system in a bright environment. Monitor the voltage on the supercapacitor using the TP3 (BATT) and TP5 (GND) test points (see Figure 3).
4. The output is available on J4\_1 on the [ADP5090-2-EVALZ](#) board.



Figure 3. Jumper Setup

## EVALUATION BOARD HARDWARE

### POWER MANAGEMENT OF THE OUTPUT (LDO)

A low dropout ([ADP161](#)) is included on the demo board (the [ADP5090-2-EVALZ](#) evaluation board). This regulator chooses different output voltages. Table 1 shows the jumper connections and the corresponding output voltage on the [ADP5090-2-EVALZ](#) evaluation board. See the Evaluation Board Schematic and Artwork section for more details. Set the output of the demo board corresponding to each Table 1 setting as shown in Figure 4 to Figure 8.

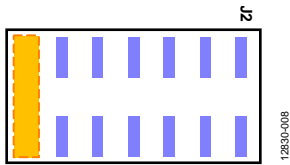

Figure 4. Jumper Position on Demonstration Board for Setting 1

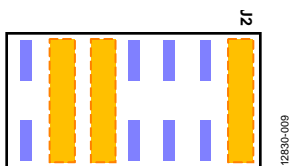

Figure 5. Jumper Position on Demonstration Board for Setting 2

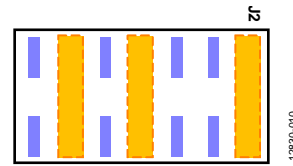

Figure 6. Jumper Position on Demonstration Board for Setting 3

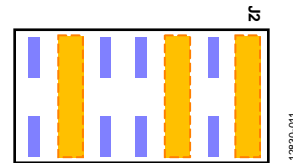

Figure 7. Jumper Position on Demonstration Board for Setting 4

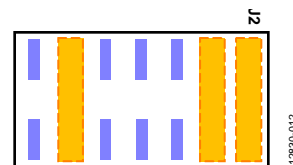

Figure 8. Jumper Position on Demonstration Board for Setting 5

**Table 1. Power Management of Sensor Nodes**

Setting	VOUT Pin (V)	Jumper Position
1	3.5 V (LDO bypassed)	J2_13 and J2_14 (see Figure 4)
2	2 V	J2_1 and J2_2, J2_9 and J2_10, and J2_11 and J2_12 (see Figure 5)
3	2.4 V	J2_1 and J2_2, J2_7 and J2_8, and J2_11 and J2_12 (see Figure 6)
4	3 V	J2_1 and J2_2, J2_5 and J2_6, and J2_11 and J2_12 (see Figure 7)
5	3.3 V	J2_1 and J2_2, J2_3 and J2_4, and J2_11 and J2_12 (see Figure 8)

**J4 OUTPUT CONNECTOR**

The J4 output connector (see Figure 9) connects the demo board to the load. As well as providing power, the connector also has other interface connections that allow more interaction between the demo board and the host microcontroller unit (MCU) on the load. The connector is directly compatible with the Analog Devices WSN demo boards. Table 2 shows the pinout of the J4 output connector and provides a brief description of the pin functions.

**Table 2. J4 Output Connector**

Pin No.	Mnemonic	Description
1	VOUT	Output voltage supply from the demo board to the load
2	PGOOD	PGOOD output signal from the ADP5090
3	GND	Ground
4	DIS_SW	DIS_SW input signal to the ADP5090
5	BATT	Supercapacitor voltage (for battery monitoring)
6	EN	Enable LDO
7	BACK_UP	Backup voltage (for battery monitoring)
8	NC	No connect

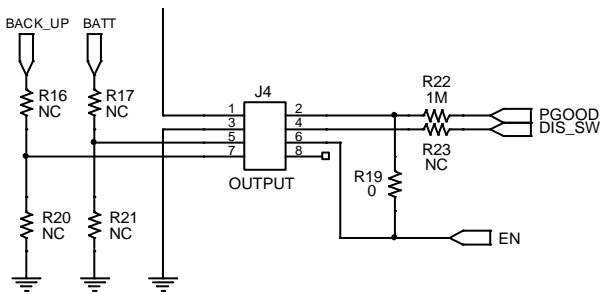

Figure 9. J4 Output Connector

A detailed description of each J4 output connector pin is as follows:

- The VOUT pin (Pin 1) is the output voltage that the demo board delivers to the load.
- The ADP5090 has a programmable PGOOD signal. When the PGOOD threshold is reached, the ADP5090 sets the PGOOD pin (Pin 2) high. The pin is connected to the host MCU GPIO input. See the ADP5090 data sheet for more information on this function.
- The GND pin (Pin 3) is the ground connection for the ADP5090.
- Connect the DIS\_SW pin (Pin 4) to the host MCU GPIO output. If the host MCU requires the ADP5090 to temporarily halt the switching regulator function, set this pin high. See the ADP5090 data sheet for more detailed information on this function.
- Connect the BATT pin (Pin 5) to the analog input of the host MCU to monitor the voltage on the supercapacitor of the ADP5090 demo board (ADP5090-2-EVALZ). Populating Resistor R17 and Resistor R21 creates a resistor divider for cases where the MCU analog input range is lower than the supercapacitor voltage.
- The EN pin (Pin 6) is the enable control signal for the ADP161 LDO regulator on the ADP5090 demo board (ADP5090-2-EVALZ). Connect this pin to the host MCU GPIO output to enable or disable the ADP161.
- Connect the BACK\_UP pin (Pin 7) to the analog input of the host MCU to monitor the voltage on the supercapacitor of the ADP5090 demo board (ADP5090-2-EVALZ). Populating Resistor R16 and Resistor R20 creates a resistor divider for cases where the MCU analog input range is lower than the supercapacitor voltage.
- The NC pin (Pin 8) is the no connect pin. Do not use this pin.

EVALUATION BOARD SCHEMATIC AND ARTWORK

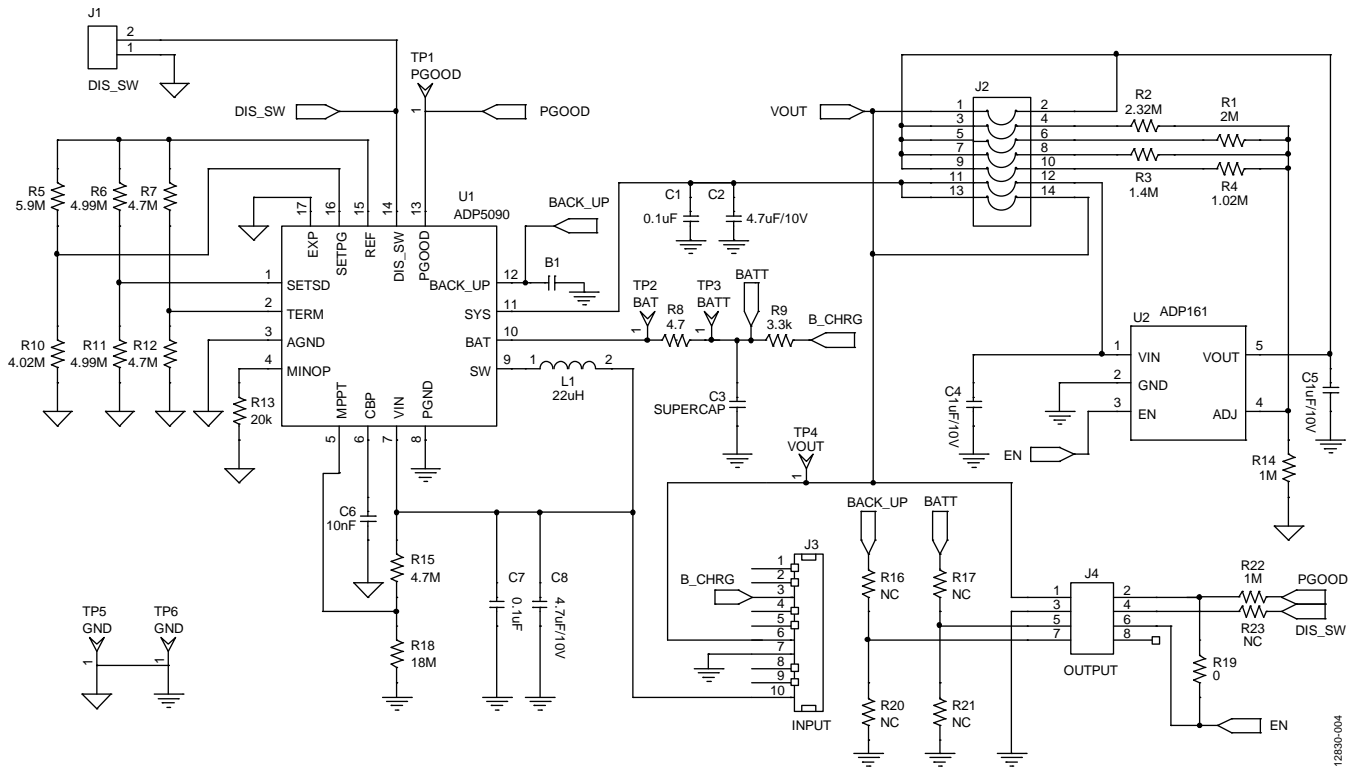

Figure 10. ADP5090-2-EVALZ Evaluation Board

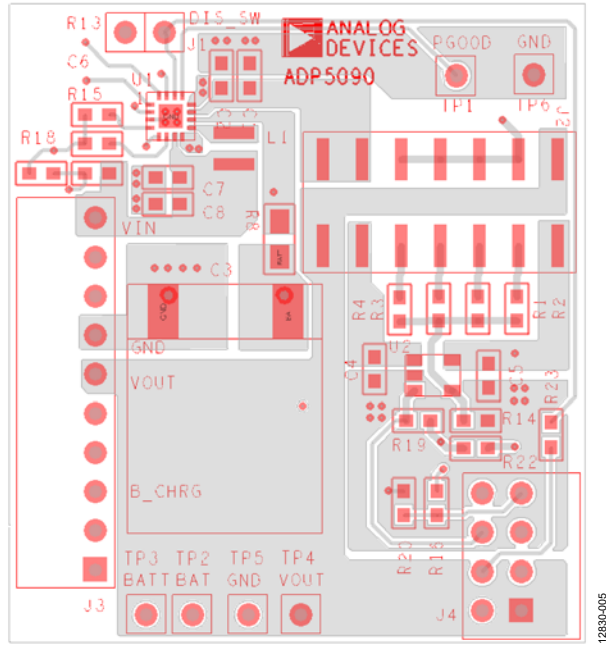

Figure 11. ADP5090-2-EVALZ Evaluation Board Top Assembly

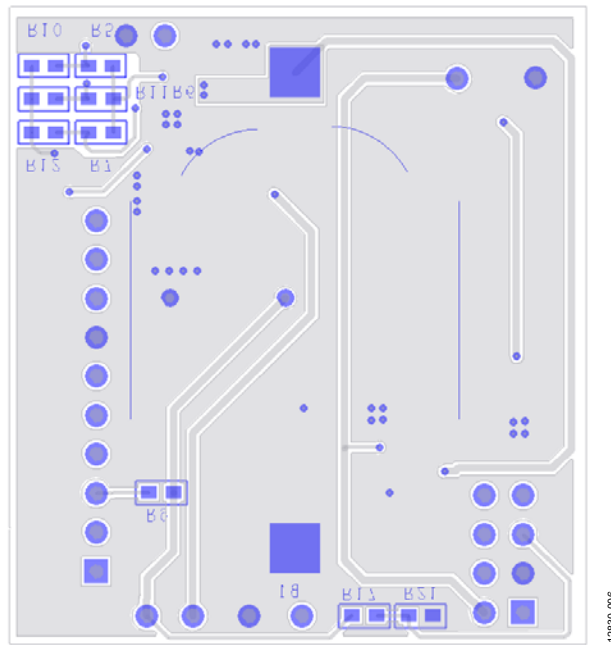

Figure 12. ADP5090-2-EVALZ Evaluation Board Bottom Assembly

## BILL OF MATERIALS

Table 3. Bill of Materials

Quantity	Reference	Description	Part Number	Vendor
1	B1	CR2032 holder	BC2032-F1	Memory Protection Devices
2	C1, C7	0.1 $\mu$ F capacitors, C0603	GRM188R71H104KA93	Murata
2	C2, C8	4.7 $\mu$ F, 10 V capacitors, C0603	GRM21BR61A475KA73	Murata
1	C3	Supercapacitor, 12 $\times$ 12	PB-5R0H104-R	Cooper Bussmann
2	C4, C5	1 $\mu$ F, 10 V capacitors, C0603	GRM185R61A105KE36	Murata
1	C6	10 nF capacitor, C0603	GRM188R71H103KA01	Murata
1	J1	DIS_SW jumper, SIP2	61304011121	Würth Elektronik
1	J2	VOUT jumper, SIP14_dual	61001421121	Würth Elektronik
1	J3	INPUT jumper, SIP10_BtoB	61301011021	Würth Elektronik
1	J4	OUTPUT jumper, SIP8_2rows	61300821021	Würth Elektronik
1	J5	INPUT1 jumper, PV_INPUT	Not applicable	Alta Devices
1	J6	GND jumper, SIP3	61304011121	Würth Elektronik
1	J7	OUTPUT jumper, SIP10	613010143121	Würth Elektronik
1	J8	VIN jumper, SIP3	61304011121	Würth Elektronik
1	J9	INPUT2 jumper, PV_INPUT	Not Applicable	Alta Devices
1	L1	22 $\mu$ H inductor, 3 $\times$ 3	EPL3015-223ML, 744025220	Coilcraft®, Würth Elektronik
1	R1	2 M $\Omega$ resistor, R0603	CRCW06032M00FKEA	Vishay Dale
1	R2	2.32 M $\Omega$ resistor, R0603	CRCW06032M320FKEA	Vishay Dale
1	R3	1.4 M $\Omega$ resistor, R0603	CRCW06031M40FKEA	Vishay Dale
1	R4	1.02 M $\Omega$ resistor, R0603	CRCW06031M02FKEA	Vishay Dale
1	R5	5.9 M $\Omega$ resistor, R0603	CRCW06035M90FKEA	Vishay Dale
2	R6, R11	4.99 M $\Omega$ resistors, R0603	CRCW06034M99FKEA	Vishay Dale
3	R7, R12, R15	4.7 M $\Omega$ resistors, R0603	CRCW06034M70FKEA	Vishay Dale
1	R8	4.7 $\Omega$ resistor, R0805	CRCW08054R70JNEAIF	Vishay Dale
1	R9	3.3 k $\Omega$ resistor, R0603	CRCW06033K3FKEA	Vishay Dale
1	R10	4.02 M $\Omega$ resistor, R0603	CRCW06034M02FKEA	Vishay Dale
1	R13	20 k $\Omega$ resistor, R0603	CRCW060320K0FKEA	Vishay Dale
2	R14, R22	1 M $\Omega$ resistors, R0603	CRCW06031M00FKEA	Vishay Dale
5	R16, R17, R20, R21, R23	NC (no connect) resistors, R0603	Not Applicable	Not Applicable
1	R18	18 M $\Omega$ resistor, R0603	RK73B1JT186J	KOA
1	R19	0 $\Omega$ resistor, R0603	CRCW06030000FKEA	Vishay Dale
1	TP1	PGOOD test point, SIP1	61304011121	Würth Elektronik
1	TP2	BAT test point, SIP1	61304011121	Würth Elektronik
1	TP3	BATT test point, SIP1	61304011121	Würth Elektronik
1	TP4	VOUT test points, SIP1	61304011121	Würth Elektronik
2	TP5, TP6	GND test points, SIP1	61304011121	Würth Elektronik
1	U1	<a href="#">ADP5090</a> 16-lead LFCSP	ADP5090ACPZ-1-R7	Analog Devices
1	U2	<a href="#">ADP161</a> 5-lead SOT-23	ADP161AUJZ-R7	Analog Devices

## NOTES



### ESD Caution

**ESD (electrostatic discharge) sensitive device.** Charged devices and circuit boards can discharge without detection. Although this product features patented or proprietary protection circuitry, damage may occur on devices subjected to high energy ESD. Therefore, proper ESD precautions should be taken to avoid performance degradation or loss of functionality.

### Legal Terms and Conditions

By using the evaluation board discussed herein (together with any tools, components documentation or support materials, the "Evaluation Board"), you are agreeing to be bound by the terms and conditions set forth below ("Agreement") unless you have purchased the Evaluation Board, in which case the Analog Devices Standard Terms and Conditions of Sale shall govern. Do not use the Evaluation Board until you have read and agreed to the Agreement. Your use of the Evaluation Board shall signify your acceptance of the Agreement. This Agreement is made by and between you ("Customer") and Analog Devices, Inc. ("ADI"), with its principal place of business at One Technology Way, Norwood, MA 02062, USA. Subject to the terms and conditions of the Agreement, ADI hereby grants to Customer a free, limited, personal, temporary, non-exclusive, non-sublicensable, non-transferable license to use the Evaluation Board FOR EVALUATION PURPOSES ONLY. Customer understands and agrees that the Evaluation Board is provided for the sole and exclusive purpose referenced above, and agrees not to use the Evaluation Board for any other purpose. Furthermore, the license granted is expressly made subject to the following additional limitations: Customer shall not (i) rent, lease, display, sell, transfer, assign, sublicense, or distribute the Evaluation Board; and (ii) permit any Third Party to access the Evaluation Board. As used herein, the term "Third Party" includes any entity other than ADI, Customer, their employees, affiliates and in-house consultants. The Evaluation Board is NOT sold to Customer; all rights not expressly granted herein, including ownership of the Evaluation Board, are reserved by ADI. CONFIDENTIALITY. This Agreement and the Evaluation Board shall all be considered the confidential and proprietary information of ADI. Customer may not disclose or transfer any portion of the Evaluation Board to any other party for any reason. Upon discontinuation of use of the Evaluation Board or termination of this Agreement, Customer agrees to promptly return the Evaluation Board to ADI. ADDITIONAL RESTRICTIONS. Customer may not disassemble, decompile or reverse engineer chips on the Evaluation Board. Customer shall inform ADI of any occurred damages or any modifications or alterations it makes to the Evaluation Board, including but not limited to soldering or any other activity that affects the material content of the Evaluation Board. Modifications to the Evaluation Board must comply with applicable law, including but not limited to the RoHS Directive. TERMINATION. ADI may terminate this Agreement at any time upon giving written notice to Customer. Customer agrees to return to ADI the Evaluation Board at that time. LIMITATION OF LIABILITY. THE EVALUATION BOARD PROVIDED HEREUNDER IS PROVIDED "AS IS" AND ADI MAKES NO WARRANTIES OR REPRESENTATIONS OF ANY KIND WITH RESPECT TO IT. ADI SPECIFICALLY DISCLAIMS ANY REPRESENTATIONS, ENDORSEMENTS, GUARANTEES, OR WARRANTIES, EXPRESS OR IMPLIED, RELATED TO THE EVALUATION BOARD INCLUDING, BUT NOT LIMITED TO, THE IMPLIED WARRANTY OF MERCHANTABILITY, TITLE, FITNESS FOR A PARTICULAR PURPOSE OR NON-INFRINGEMENT OF INTELLECTUAL PROPERTY RIGHTS. IN NO EVENT WILL ADI AND ITS LICENSORS BE LIABLE FOR ANY INCIDENTAL, SPECIAL, INDIRECT, OR CONSEQUENTIAL DAMAGES RESULTING FROM CUSTOMER'S POSSESSION OR USE OF THE EVALUATION BOARD, INCLUDING BUT NOT LIMITED TO LOST PROFITS, DELAY COSTS, LABOR COSTS OR LOSS OF GOODWILL. ADI'S TOTAL LIABILITY FROM ANY AND ALL CAUSES SHALL BE LIMITED TO THE AMOUNT OF ONE HUNDRED US DOLLARS (\$100,000). EXPORT. Customer agrees that it will not directly or indirectly export the Evaluation Board to another country, and that it will comply with all applicable United States federal laws and regulations relating to exports. GOVERNING LAW. This Agreement shall be governed by and construed in accordance with the substantive laws of the Commonwealth of Massachusetts (excluding conflict of law rules). Any legal action regarding this Agreement will be heard in the state or federal courts having jurisdiction in Suffolk County, Massachusetts, and Customer hereby submits to the personal jurisdiction and venue of such courts. The United Nations Convention on Contracts for the International Sale of Goods shall not apply to this Agreement and is expressly disclaimed.

©2015–2019 Analog Devices, Inc. All rights reserved. Trademarks and registered trademarks are the property of their respective owners.  
UG12830-0-9/19(A)



www.analog.com

## Looking for pricing, stock, or lifecycle information?

Click below to explore more details on WIN SOURCE:

- ⊖ [View ADP5090-2-EVALZ on WIN SOURCE](#)
- ⊖ [Analog Devices Inc. Information](#)

## Optimize Your Supply Chain with WIN SOURCE Solutions

- ✓ Global Sourcing Solution
- ✓ Obsolete Management
- ✓ Cost Control Management
- ✓ Shortage Management
- ✓ Alternative Solution
- ✓ Excess Inventory Management