

FEATURES

Triaxial, digital gyroscope

- ±125°/sec, ±450°/sec, ±2000°/sec range options
- ±0.05° axis to axis misalignment error
- ±0.25° (maximum) axis to package misalignment error
- 0.8°/hr in-run bias stability (ADIS16497-1)
- 0.09°/√hr angular random walk (ADIS16497-1)

Triaxial, digital accelerometer, ±40 g

- 13 μg in run bias stability

Triaxial, delta angle and delta velocity outputs

Factory calibrated sensitivity, bias, and axial alignment

- Calibration temperature range: -40°C to +85°C

SPI compatible

Programmable operation and control

- Automatic and manual bias correction controls
- Configurable FIR filters
- Digital I/O: data ready, external clock
- Sample clock options: internal, external, or scaled
- On demand self test of inertial sensors

Single-supply operation: 3.0 V to 3.6 V

1500 g mechanical shock survivability

Operating temperature range: -40°C to +105°C

APPLICATIONS

Precision instrumentation, stabilization

Guidance, navigation, control

Avionics, unmanned vehicles

Precision autonomous machines, robotics

GENERAL DESCRIPTION

The ADIS16497 is a complete inertial system that includes a triaxis gyroscope and a triaxis accelerometer. Each inertial sensor in the ADIS16497 combines industry leading iMEMS® technology with signal conditioning that optimizes dynamic performance. The factory calibration characterizes each sensor for sensitivity, bias, alignment, and linear acceleration (gyroscope bias). As a result, each sensor has its own dynamic compensation formulas that provide accurate sensor measurements.

The ADIS16497 provides a simple, cost effective method for integrating accurate, multi-axis inertial sensing into industrial systems, especially when compared with the complexity and investment associated with discrete designs. All necessary motion testing and calibration are part of the production process at the factory, greatly reducing system integration time. Tight orthogonal alignment simplifies inertial frame alignment in navigation systems. The serial peripheral interface (SPI) and register structure provide a simple interface for data collection and configuration control.

The footprint and connector system of the ADIS16497 enable a simple upgrade from the [ADIS16375](#), [ADIS16480](#), [ADIS16485](#), [ADIS16488A](#), and [ADIS16490](#). The ADIS16497 is available in an aluminum package that is approximately 47 mm × 44 mm × 14 mm and includes a standard connector interface.

FUNCTIONAL BLOCK DIAGRAM

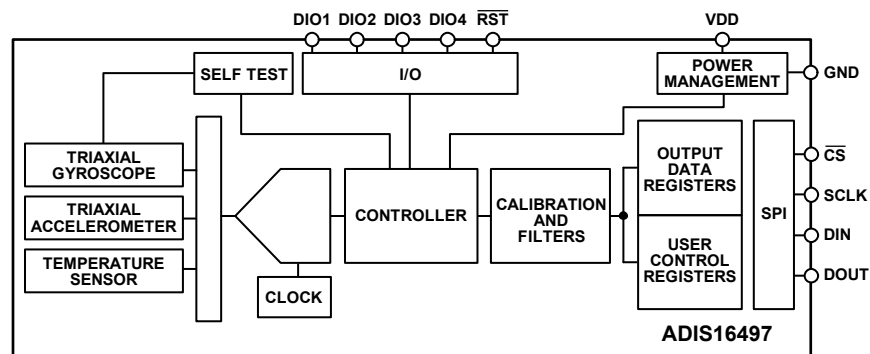

Figure 1.

Rev. D

Document Feedback

Information furnished by Analog Devices is believed to be accurate and reliable. However, no responsibility is assumed by Analog Devices for its use, nor for any infringements of patents or other rights of third parties that may result from its use. Specifications subject to change without notice. No license is granted by implication or otherwise under any patent or patent rights of Analog Devices. Trademarks and registered trademarks are the property of their respective owners.

TABLE OF CONTENTS

Features.....	1	Cyclical Redundancy Check (CRC-32).....	25
Applications	1	Delta Angles.....	26
General Description.....	1	Delta Velocity	27
Functional Block Diagram	1	User Bias/Scale Adjustment.....	29
Revision History	2	Scratch Registers, USER_SCR_x.....	32
Specifications	4	Flash Memory Endurance Counter, FLSHCNT_LOW, FLSHCNT_HIGH.....	32
Timing Specifications	6	Global Commands, GLOB_CMD	33
Absolute Maximum Ratings	9	Auxiliary I/O Line Configuration, FNCTIO_CTRL.....	34
Thermal Resistance	9	General-Purpose I/O Control, GPIO_CTRL.....	35
ESD Caution.....	9	Miscellaneous Configuration, CONFIG.....	35
Pin Configuration and Function Descriptions	10	Linear Acceleration on Effect on Gyroscope Bias	35
Typical Performance Characteristics.....	11	Decimation Filter, DEC_RATE	35
Theory of Operation	13	Continuous Bias Estimation (CBE), NULL_CNFG.....	36
Inertial Sensor Signal Chain	13	Scaling the Input Clock (PPS Mode), SYNC_SCALE.....	36
Register Structure	14	FIR Filters.....	37
Serial Peripheral Interface.....	15	Firmware Revision, FIRM_REV	39
Data Ready	15	Firmware Revision Year, FIRM_Y	39
Reading Sensor Data.....	16	Boot Revision Number, BOOT_REV.....	39
Device Configuration	17	Continuous SRAM Testing.....	39
User Register Memory Map.....	18	Applications Information	41
User Register Definitions	21	Mounting Best Practices	41
Page Number (PAGE_ID)	21	Preventing Misinsertion.....	41
Data/Sample Counter (DATA_CNT)	21	Evaluation Tools.....	41
Status/Error Flag Indicators (SYS_E_FLAG).....	21	Power Supply Considerations	41
Self Test Error Flags (DIAG_STS)	22	CRC32 Coding Example	42
Internal Temperature (TEMP_OUT)	22	Outline Dimensions.....	43
Gyroscope Data	22	Ordering Guide	43
Acceleration Data.....	24		
Time Stamp	25		

REVISION HISTORY

7/2020—Rev. C to Rev. D

Changes to Table 1	5
Changes to Table 2	6
Changes to Flash Memory Update Section and On Demand Self Test (ODST) Section	33
Changes to Data Ready Indicator Section	34
Changes to Scaling the Input Clock (PPS Mode), SYNC_SCALE.....	36

1/2020—Rev. B to Rev. C

Changes to Accelerometers, Sensitivity Parameter, Table 1	1
---	---

6/2019—Rev. A to Rev. B

Changes to Features Section	1
Changes to Specifications Section and Table 1	4
Changes to Figure 5 and Figure 6	7
Changes to Table 6.....	9
Changes to Figure 12	10

Added Figure 13 and Figure 14; Renumbered Sequentially10
 Added Figure 15, Figure 16, Figure 17, Figure 18, Figure 19,
 and Figure 2011
 Changes to Theory of Operation Section12
 Change to Serial Peripheral Interface Section.....14
 Changes to Burst Read Function Section and Table 10.....15
 Changes to Table 11.....16
 Changes to Table 12.....17
 Changes to Model Column, Table 24.....21
 Change to Delta Angle Measurement Range Section and Model
 Column, Table 60.....25
 Changes to Delta Velocity Section.....26

Changes to Continuous Bias Estimation (CBE), NULL_CNFG
 Section and Description Column, Table 15635
 Added CRC32 Coding Example, Table 195, and Table 196;
 Renumbered Sequentially41

11/2017—Rev. 0 to Rev. A

Changes to Table 1.....3
 Changed t_2 Parameter, Table 2; GLOB_CMD, Bit 3 Parameter,
 GLOB_CMD, Bit 6 Parameter, and GLOB_CMD, Bit 7 Parameter,
 Table 35

10/2017—Revision 0: Initial Version

SPECIFICATIONS

T_c = 25°C, VDD = 3.3 V, angular rate = 0°/sec, ADIS16497-1 model, ±1 g, unless otherwise noted.

Table 1.

Parameter	Test Conditions/Comments	Min	Typ	Max	Unit
GYROSCOPES					
Dynamic Range	ADIS16497-1	±125			°/sec
	ADIS16497-2	±450		±480	°/sec
	ADIS16497-3	±2000			°/sec
Sensitivity	ADIS16497-1, 32-bit		10485760		LSB/°/sec
	ADIS16497-2, 32-bit		2621440		LSB/°/sec
	ADIS16497-3, 32-bit		655360		LSB/°/sec
Error Over Temperature	ADIS16497-1, -40°C ≤ T _c ≤ +85°C, 1 σ		0.1		%
	ADIS16497-2, -40°C ≤ T _c ≤ +85°C, 1 σ		0.2		%
	ADIS16497-3, -40°C ≤ T _c ≤ +85°C, 1 σ		0.2		%
Misalignment	Axis to axis, -40°C ≤ T _c ≤ +85°C, 1 σ		±0.05		Degrees
	Axis to package, -40°C ≤ T _c ≤ +85°C			±0.25	Degrees
Nonlinearity ¹	1 σ, ADIS16497-1, FS = 125°/sec		0.2		% FS
	1 σ, ADIS16497-2, FS = 450°/sec		0.2		% FS
	1 σ, ADIS16497-3, FS = 2000°/sec		0.25		% FS
Bias					
Repeatability ²	-40°C ≤ T _c ≤ +85°C, 1 σ		0.07		°/sec
In Run Bias Stability	1 σ, ADIS16497-1		0.8		°/hr
	1 σ, ADIS16497-2		1.6		°/hr
	1 σ, ADIS16497-3		3.3		°/hr
Angular Random Walk	1 σ, ADIS16497-1		0.09		°/√hr
	1 σ, ADIS16497-2		0.1		°/√hr
	1 σ, ADIS16497-3		0.18		°/√hr
Error over Temperature	-40°C ≤ T _c ≤ +85°C, 1 σ		0.1		°/sec
Linear Acceleration Effect	Any axis, 1 σ (CONFIG register, Bit 7 = 1)		0.006		°/sec/g
	Any axis, 1 σ (CONFIG register, Bit 7 = 0)		0.015		°/sec/g
Vibration Rectification Error	1 σ, ADIS16497-1		0.0003		°/sec/g ²
	1 σ, ADIS16497-2		0.0004		°/sec/g ²
	1 σ, ADIS16497-3		0.0009		°/sec/g ²
Noise					
Output Noise	No filtering, ADIS16497-1		0.051		°/sec rms
	No filtering, ADIS16497-2		0.058		°/sec rms
	No filtering, ADIS16497-3		0.112		°/sec rms
Rate Noise Density ³	1 σ, ADIS16497-1		0.002		°/sec/√Hz rms
	1 σ, ADIS16497-2		0.0022		°/sec/√Hz rms
	1 σ, ADIS16497-3		0.0042		°/sec/√Hz rms
-3 dB Bandwidth	ADIS16497-1		480		Hz
	ADIS16497-2, ADIS16497-3		550		Hz
Sensor Resonant Frequency			65		kHz

Parameter	Test Conditions/Comments	Min	Typ	Max	Unit
ACCELEROMETERS⁴	Each axis	±40			
Dynamic Range			52,428,800		g
Sensitivity	32-bit data format				LSB/g
Error Over Temperature	-40°C ≤ T _C ≤ +85°C, 1 σ		±0.01		%
Misalignment	Axis to axis, -40°C ≤ T _C ≤ +85°C, 1 σ		±0.05		Degrees
	Axis to package, -40°C ≤ T _C ≤ +85°C			±0.25	Degrees
Nonlinearity	Best fit straight line, ±10 g		0.02		% FS
	Best fit straight line, ±20 g		0.4		% FS
	Best fit straight line, ±40 g		1.5		% FS
Bias					
In Run Bias Stability	1 σ		13		μg
Velocity Random Walk	1 σ		0.04		m/sec/√hr
Error over Temperature	-40°C ≤ T _C ≤ +85°C, 1 σ		±0.5		mg
Repeatability	-40°C ≤ T _C ≤ +85°C, 1 σ		6		mg
Noise					
Output Noise	No filtering		2.6		mg rms
Noise Density	10 Hz to 40 Hz, no filtering		88		μg/√Hz rms
-3 dB Bandwidth			750		Hz
Sensor Resonant Frequency			5.5		kHz
TEMPERATURE SENSOR					
Scale Factor	Output = 0x0000 at 25°C (±5°C)		0.0125		°C/LSB
LOGIC INPUTS⁵					
Input Voltage		2.0			V
High, V _{IH}				0.8	V
Low, V _{IL}					μs
RST Pulse Width		1			
Input Current				10	μA
Logic 1, I _{IH}	V _{IH} = 3.3 V				μA
Logic 0, I _{IL}	V _{IL} = 0 V			10	μA
All Pins Except RST, CS					μA
RST, CS Pins ⁶			0.33		mA
Input Capacitance, C _{IN}			10		pF
DIGITAL OUTPUTS⁵					
Output Voltage					
High, V _{OH}	I _{SOURCE} = 0.5 mA	2.4			V
Low, V _{OL}	I _{SINK} = 2.0 mA			0.4	V
FLASH MEMORY					
Data Retention ⁸	Endurance ⁷	100,000			Cycles
	T _J = 85°C	20			Years
FUNCTIONAL TIMES⁹					
Power-On Start-Up Time	Time until data is available, -40°C ≤ T _C ≤ +85°C, 1 σ		265		ms
Reset Recovery Time ¹⁰	GLOB_CMD, Bit 7 = 1 (see Table 142)		225		ms
	RST pulled low, then restored to high		265		ms
Flash Memory					
Update Time	GLOB_CMD, Bit 3 = 1 (see Table 142)		1300		ms
Clear User Calibration	GLOB_CMD, Bit 6 = 1 (see Table 142)		350		μs
Self Test Time	GLOB_CMD, Bit 1 = 1 (see Table 142)		30		ms

Parameter	Test Conditions/Comments	Min	Typ	Max	Unit
CONVERSION RATE			4.25		kSPS
Initial Clock Accuracy			0.02		%
Temperature Coefficient			40		ppm/°C
Sync Input Clock		3.0		4.5	kHz
Pulse Per Second (PPS) Mode		1		128	Hz
POWER SUPPLY, VDD	Operating voltage range	3.0		3.6	V
Power Supply Current ¹¹	Normal mode, VDD = 3.3 V, $\mu + \sigma$		89		mA

¹ FS = full scale, FS = 125°/sec (ADIS16497-1), FS = 450°/sec (ADIS16497-2), FS = 2000°/sec (ADIS16497-3).

² Bias repeatability provides an estimate for long-term drift in the bias, as observed during 500 hours of high temperature operating life (HTOL) at +105°C.

³ Magnitude between 10 and 40 Hz, sample rate is 4250 SPS (nominal), no digital filtering.

⁴ All specifications associated with the accelerometers relate to the full-scale range of $\pm 40 g$.

⁵ The digital I/O signals use a 3.3 V system.

⁶ \overline{RST} and \overline{CS} pins are connected to the VDD pin through 10 k Ω pull-up resistors.

⁷ Endurance is qualified as per JEDEC Standard 22, Method A117, measured at -40°C, +25°C, +85°C, and +125°C.

⁸ The data retention specification assumes a junction temperature (T_j) of 85°C per JEDEC Standard 22, Method A117. Data retention lifetime decreases with T_j .

⁹ These times do not include thermal settling and internal filter response times, which can affect overall accuracy.

¹⁰ The \overline{RST} line must be in a low state for at least 10 μs to ensure a proper reset initiation and recovery.

¹¹ Supply current transients can reach 250 mA during initial startup or reset recovery.

TIMING SPECIFICATIONS

$T_C = 25^\circ C$, VDD = 3.3 V, unless otherwise noted.

Table 2.

Parameter	Description	Normal Mode			Burst Read Function			Unit
		Min ¹	Typ	Max ¹	Min	Typ	Max ¹	
f_{SCLK}	SCLK frequency	0.01		15			6.5	MHz
t_{STALL}^2	Stall period between data	5				N/A ³		μs
t_{CLS}	SCLK low period	31			31			ns
t_{CHS}	SCLK high period	31			31			ns
$t_{\overline{CS}}$	\overline{CS} to SCLK edge	32			32			ns
t_{DAV}	DOUT valid after SCLK edge			10			10	ns
t_{DSU}	DIN setup time before SCLK rising edge	2			2			ns
t_{DHD}	DIN hold time after SCLK rising edge	2			2			ns
t_{DR}, t_{DF}	DOUT rise/fall times, $\leq 100 pF$ loading		3	8		3	8	ns
t_{DSOE}	\overline{CS} assertion to DOUT active	0		11	0		11	ns
t_{HD}	SCLK edge to DOUT invalid	0			0			ns
t_{SFS}	Last SCLK edge to \overline{CS} deassertion	32			32			ns
t_{DSHI}	\overline{CS} deassertion to DOUT high impedance	0		9	0		9	ns
t_{NV}	Data invalid time		20			20		μs
t_1	Input sync pulse width	5			5			μs
t_2	Input sync to data invalid		306			306		μs
t_3	Input sync period ⁴	222.2			222.2			μs

¹ Guaranteed by design and characterization, but not tested in production.

² See Table 3 for exceptions to the stall time rating. Note that an insufficient stall time results in reading all 0s for the register attempting to be read.

³ N/A means not applicable.

⁴ This measurement represents the inverse of the maximum frequency for the input sample clock: 4500 Hz.

Register Specific Stall Times

Table 3.

Parameter	Description	Min ¹	Typ	Max	Unit
STALL TIME					
FNCTIO_CTRL	Configure the DIOx functions	340			μs
FILTR_BNK_0	Enable/select finite impulse response (FIR) filter banks	65			μs
FILTR_BNK_1	Enable/select FIR filter banks	65			μs
NULL_CNFG	Configure autonull bias function	71			μs
SYNC_SCALE	Configure input clock scale factor	340			μs
DEC_RATE	Configure decimation rate	340			μs
GPIO_CTRL	Configure general-purpose input/output (I/O) lines	45			μs
CONFIG	Configure miscellaneous functions	45			μs
GLOB_CMD, Bit 1	On demand self test	20			ms
GLOB_CMD, Bit 3	Flash memory update	1120			ms
GLOB_CMD, Bit 6	Clear user calibration	350			μs
GLOB_CMD, Bit 7	Software reset	210			ms

¹ Monitoring the data ready signal (see Table 144 for FNCTIO_CTRL configuration) for the return of regular pulsing can help minimize system wait times.

Timing Diagrams

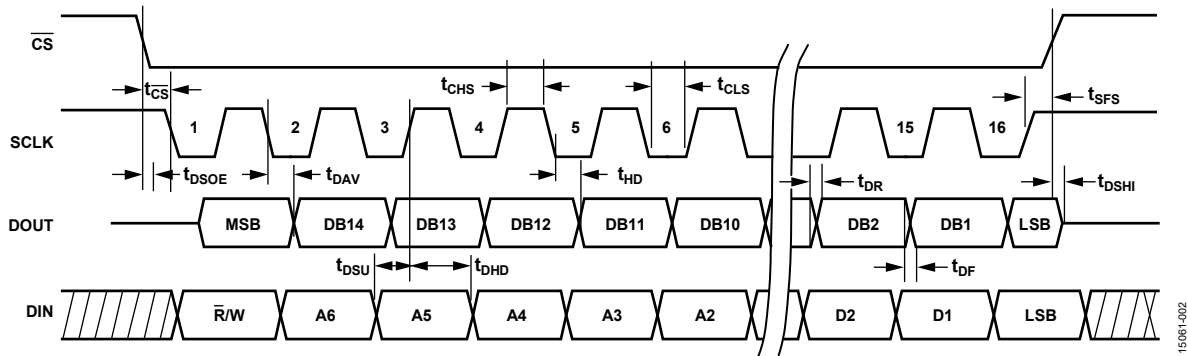

Figure 2. SPI Timing and Sequence

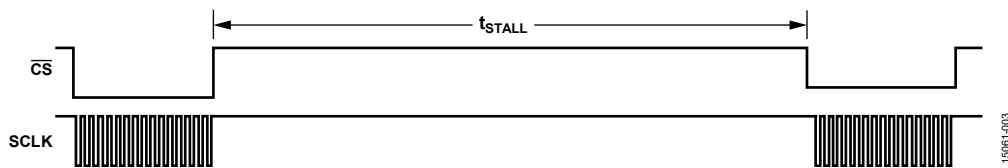

Figure 3. Stall Time and Data Rate

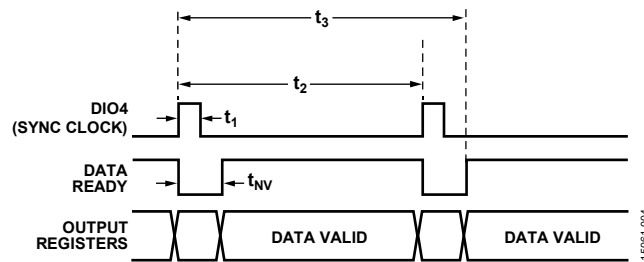

Figure 4. Input Clock Timing Diagram, FNCTIO_CTRL, Bits[7:4] = 0xFD

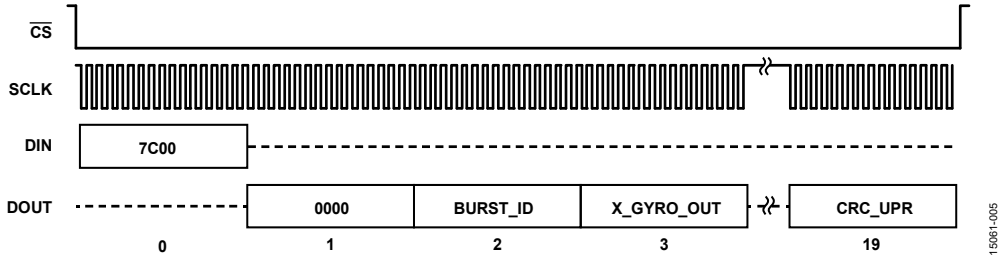

Figure 5. Burst Read Function Sequence Diagram, 19 Segments



Figure 6. Burst Read Function Sequence Diagram, 20 Segments

ABSOLUTE MAXIMUM RATINGS

Table 4.

Parameter	Rating
Mechanical Shock Survivability	
Any Axis, Unpowered	1500 g
Any Axis, Powered	1500 g
VDD to GND	−0.3 V to +3.6 V
Digital Input Voltage to GND	−0.3 V to VDD + 0.2 V
Digital Output Voltage to GND	−0.3 V to VDD + 0.2 V
Operating Temperature Range	−40°C to +105°C
Storage Temperature Range ¹	−55°C to +150°C
Barometric Pressure	2 bar

¹ Extended exposure to temperatures that are lower than −40°C or higher than +105°C can adversely affect the accuracy of the factory calibration.

Stresses at or above those listed under Absolute Maximum Ratings may cause permanent damage to the product. This is a stress rating only; functional operation of the product at these or any other conditions above those indicated in the operational section of this specification is not implied. Operation beyond the maximum operating conditions for extended periods may affect product reliability.

THERMAL RESISTANCE

Thermal performance is directly linked to printed circuit board (PCB) design and operating environment. Pay careful attention to PCB thermal design.

θ_{JA} is the natural convection junction to ambient thermal resistance measured in a one cubic foot sealed enclosure.

θ_{JC} is the junction to case thermal resistance.

The ADIS16497 is a multichip module, which includes many active components. The values in Table 5 identify the thermal response of the hottest component inside of the ADIS16497, with respect to the overall power dissipation of the module. This approach enables a simple method for predicting the temperature of the hottest junction, based on either ambient or case temperature.

For example, when $T_A = 70^\circ\text{C}$, the hottest junction inside of the ADIS16497 is 76.7°C .

$$T_J = \theta_{JA} \times V_{DD} \times I_{DD} + 70^\circ\text{C}$$

$$T_J = 22.8^\circ\text{C}/\text{W} \times 3.3 \text{ V} \times 0.089 \text{ A} + 70^\circ\text{C}$$

$$T_J = 76.7^\circ\text{C}$$

Table 5. Package Characteristics

Package Type	θ_{JA}	θ_{JC}	Device Weight
ML-24-9 ¹	30.7°C/W	20.9°C/W	42 g

¹ Thermal impedance simulated values come from a case with 4 M2 × 0.4 mm machine screws (torque = 20 inch ounces). Secure the ADIS16497 to the PCB.

ESD CAUTION



ESD (electrostatic discharge) sensitive device. Charged devices and circuit boards can discharge without detection. Although this product features patented or proprietary protection circuitry, damage may occur on devices subjected to high energy ESD. Therefore, proper ESD precautions should be taken to avoid performance degradation or loss of functionality.

PIN CONFIGURATION AND FUNCTION DESCRIPTIONS

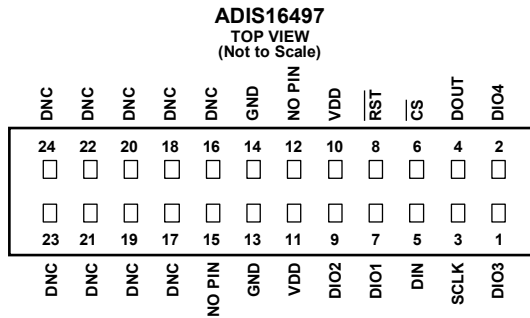

- NOTES**
1. THIS REPRESENTATION DISPLAYS THE TOP VIEW PINOUT FOR THE MATING SOCKET CONNECTOR.
 2. THE ACTUAL CONNECTOR PINS ARE NOT VISIBLE FROM THE TOP VIEW.
 3. MATING CONNECTOR: SAMTEC CLM-112-02 OR EQUIVALENT.
 4. DNC = DO NOT CONNECT.
 5. PIN 12 AND PIN 15 ARE NOT PHYSICALLY PRESENT.

Figure 7. Pin Configuration

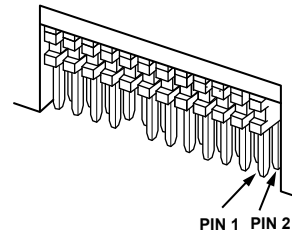
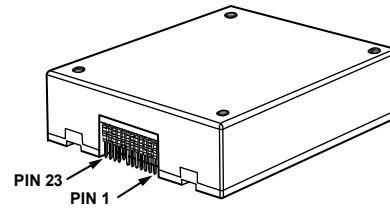

Figure 8. Axial Orientation (Top Side Facing Up)

Table 6. Pin Function Descriptions

Pin No.	Mnemonic	Type	Description
1	DIO3	Input/output	Configurable Digital Input/Output 3.
2	DIO4	Input/output	Configurable Digital Input/Output 4.
3	SCLK	Input	SPI Serial Clock.
4	DOUT	Output	SPI Data Output. Clocks output on the SCLK falling edge.
5	DIN	Input	SPI Data Input. Clocks input on the SCLK rising edge.
6	CS	Input	SPI Chip Select.
7	DIO1	Input/output	Configurable Digital Input/Output 1.
8	RST	Input	Reset.
9	DIO2	Input/output	Configurable Digital Input/Output 2.
10, 11	VDD	Supply	Power Supply.
12, 15	NO PIN	Not applicable	No Pin. These pins are not physically present.
13, 14	GND	Supply	Power Ground.
16 to 22, 24	DNC	Not applicable	Do Not Connect. Do not connect to these pins.
23	DNC	Not applicable	Do Not Connect. Do not connect to this pin. This pin can tolerate connection to the VDD supply.

TYPICAL PERFORMANCE CHARACTERISTICS

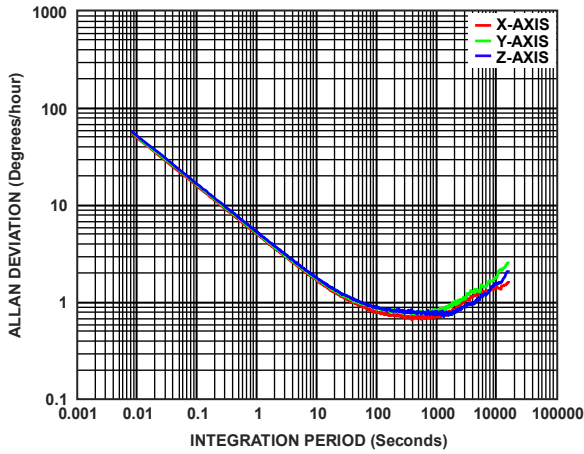

Figure 9. Gyroscope Allan Deviation, ADIS16497-1

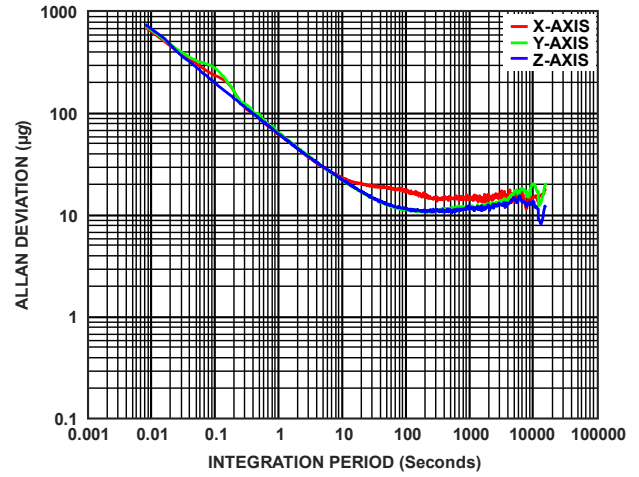

Figure 12. Accelerometer Allan Deviation

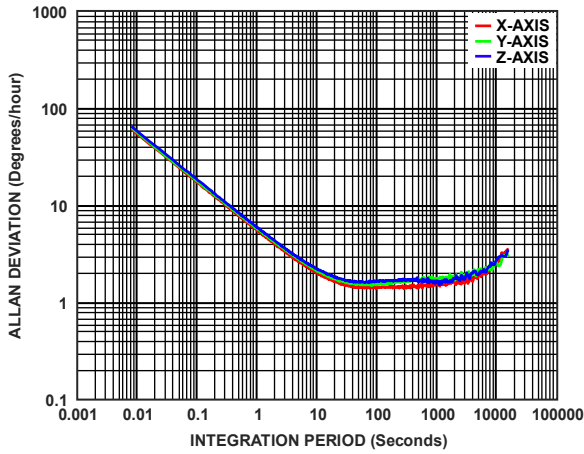

Figure 10. Gyroscope Allan Deviation, ADIS16497-2

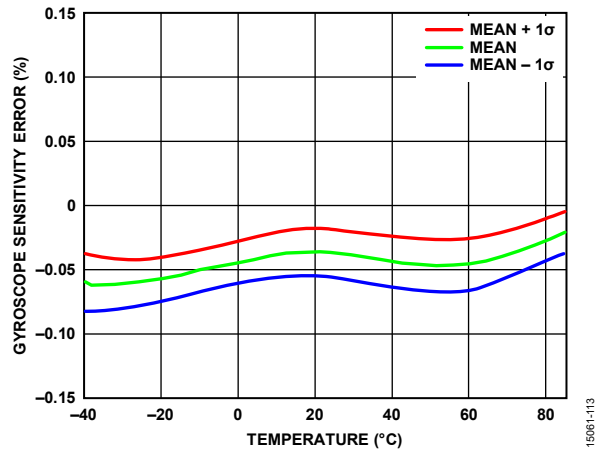

Figure 13. Gyroscope Sensitivity Error vs. Temperature, Cold to Hot, ADIS16497-2

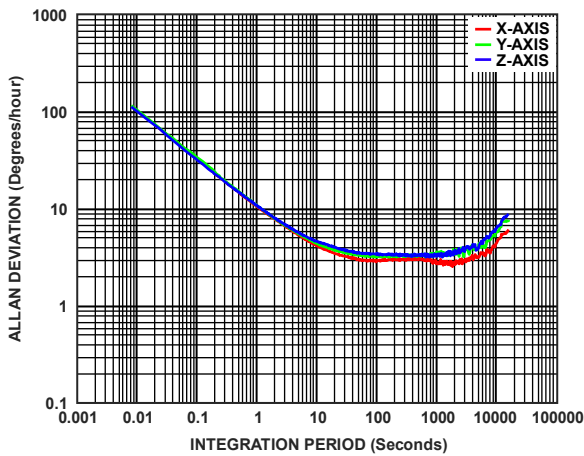

Figure 11. Gyroscope Allan Deviation, ADIS16497-3

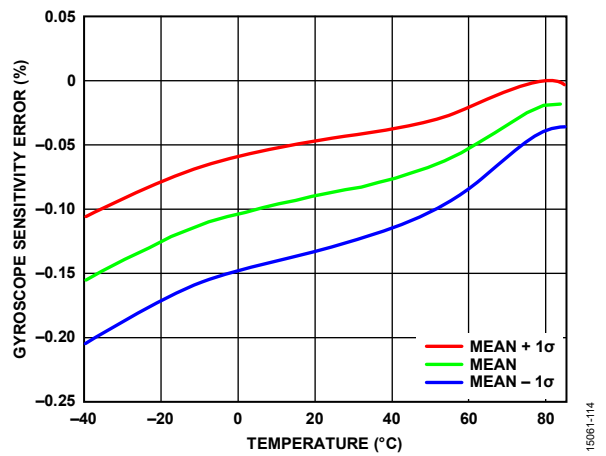

Figure 14. Gyroscope Sensitivity Error vs. Temperature, Hot to Cold, ADIS16497-2

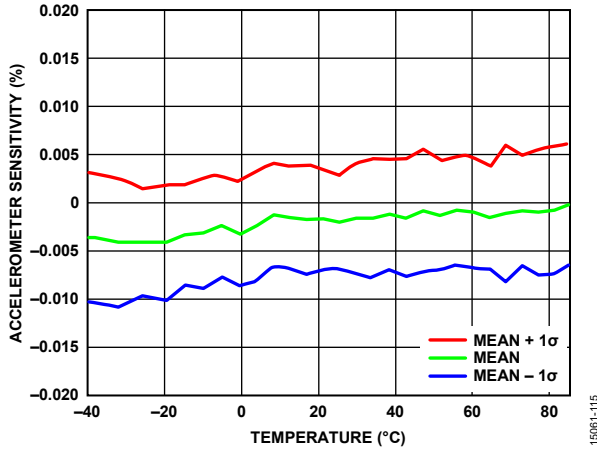

Figure 15. Accelerometer Sensitivity vs. Temperature, Cold to Hot, ADIS16497-2

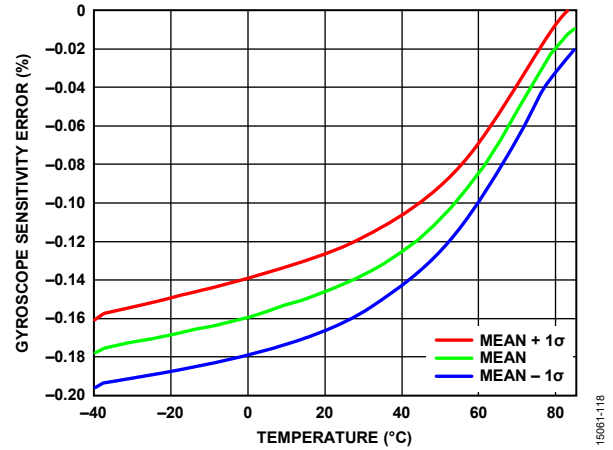

Figure 18. Gyroscope Sensitivity Error vs. Temperature, Hot to Cold, ADIS16497-3

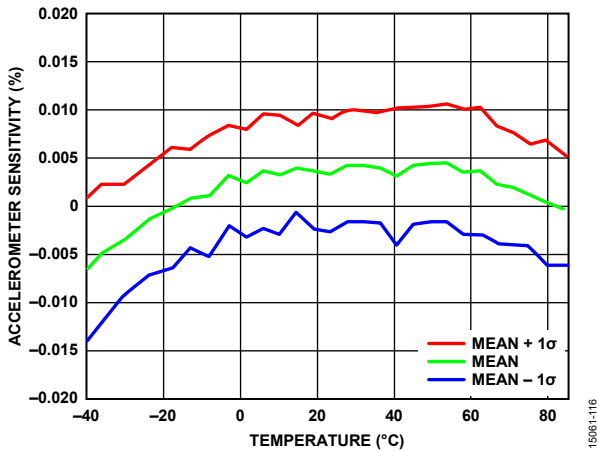

Figure 16. Accelerometer Sensitivity vs. Temperature, Hot to Cold, ADIS16497-2

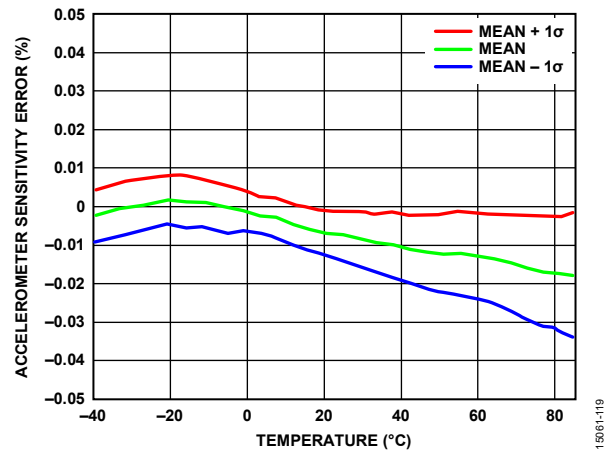

Figure 19. Accelerometer Sensitivity Error vs. Temperature, Cold to Hot, ADIS16497-3

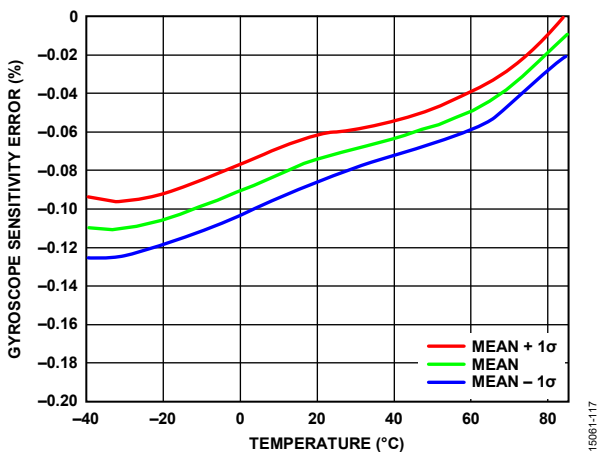

Figure 17. Gyroscope Sensitivity Error vs. Temperature, Cold to Hot, ADIS16497-3

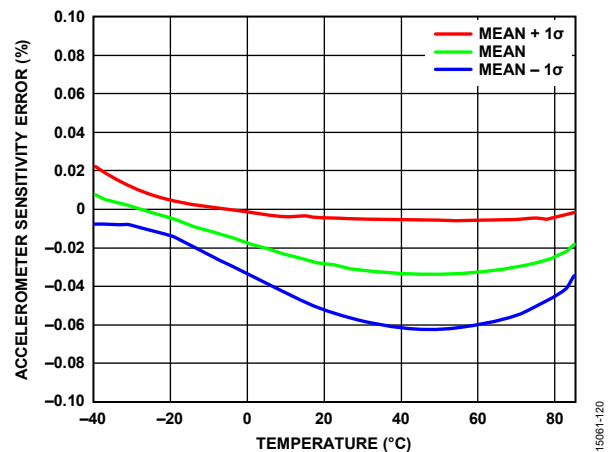

Figure 20. Accelerometer Sensitivity Error vs. Temperature, Hot to Cold, ADIS16497-3

THEORY OF OPERATION

The ADIS16497 is an autonomous sensor system. A power-on self test begins automatically after the voltage on the power supply pins reaches a minimum safe level as defined by Table 1. After the automatic power-on self test, the ADIS16497 begins sampling, processing, and loading calibrated sensor data into the output registers which are accessible using the SPI port.

INERTIAL SENSOR SIGNAL CHAIN

Figure 21 shows the basic signal chain for the inertial sensors in the ADIS16497, which processes data at a rate of 4250 SPS when using the internal sample clock. Using one of the external clock options in FNCTIO_CTRL, Bits[7:4] (see Table 144) can provide flexibility in selecting this rate.

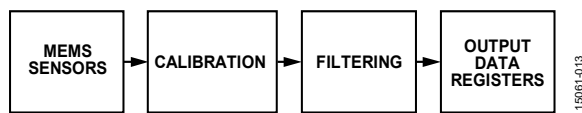

Figure 21. Signal Processing Diagram, Inertial Sensors

Gyroscope Data Sampling

The ADIS16497 produces angular rate measurements around three orthogonal axes (x, y, and z). Figure 22 shows the basic signal flow for the production of x-axis gyroscope data (same as y-axis and z-axis). This signal chain contains two digital MEMS gyroscopes (X_{G1} and X_{G2}), which have their own ADC and sample clocks (f_{SGX1} and $f_{SGX2} = 4100$ Hz) that produce data independently from each other. The sensor to sensor tolerance on this sample rate is ± 200 samples per second (SPS). Processing these data starts with combining (summation and rescale) the most recent sample from each gyroscope together by using an independent sample master frequency (f_{SM}) clock ($f_{SM} = 4250$ Hz, see Figure 22), which drives the rest of the digital signal processing (calibration, alignment, and filtering) for the gyroscopes and accelerometers.

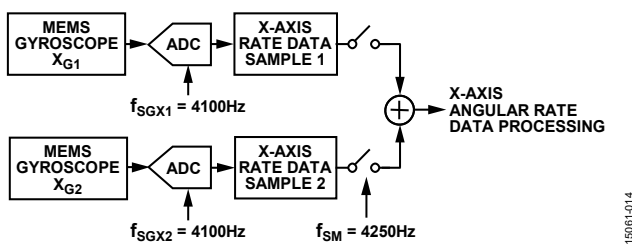

Figure 22. Gyroscope Data Sampling

Accelerometer Data Sampling

The ADIS16497 produces linear acceleration measurements along the same orthogonal axes (x, y, and z) as the gyroscopes, using the same clock (f_{SM} , see Figure 22 and Figure 23) that triggers data acquisition and subsequent processing of the gyroscope data.

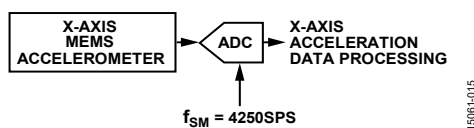

Figure 23. Accelerometer Data Sampling

External Clock Options

The ADIS16497 offers two modes of operation to control data production with an external clock: sync mode and PPS mode. In sync mode, the external clock directly controls the data sampling and production clock (f_{SM} in Figure 22 and Figure 23). In PPS mode, the user can provide a lower input clock rate (1 Hz to 128 Hz) and use a scale factor (SYNC_SCALE register, see Table 154) to establish a data collection and processing rate that is between 3000 Hz and 4250 Hz for best performance.

Inertial Sensor Calibration

The calibration function for the gyroscopes and the accelerometers has two components: factory calibration and user calibration (see Figure 24).

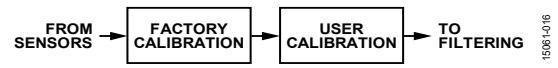

Figure 24. Gyroscope Calibration Processing

Gyroscope Factory Calibration

Gyroscope factory calibration applies the following correction formula to the data of each gyroscope:

$$\begin{bmatrix} \omega_{XC} \\ \omega_{YC} \\ \omega_{ZC} \end{bmatrix} = \begin{bmatrix} m_{11} & m_{12} & m_{13} \\ m_{21} & m_{22} & m_{23} \\ m_{31} & m_{32} & m_{33} \end{bmatrix} \times \begin{bmatrix} \omega_X \\ \omega_Y \\ \omega_Z \end{bmatrix} + \begin{bmatrix} b_X \\ b_Y \\ b_Z \end{bmatrix} + \begin{bmatrix} g_{11} & g_{12} & g_{13} \\ g_{21} & g_{22} & g_{23} \\ g_{31} & g_{32} & g_{33} \end{bmatrix} \times \begin{bmatrix} a'_X \\ a'_Y \\ a'_Z \end{bmatrix} \quad (1)$$

where:

- ω_{XC} , ω_{YC} , and ω_{ZC} are the postcalibration gyroscope data.
- m_{11} , m_{12} , m_{13} , m_{21} , m_{22} , m_{23} , m_{31} , m_{32} , and m_{33} are the scale and alignment correction factors.
- ω_X , ω_Y , and ω_Z are the precalibration gyroscope data.
- b_X , b_Y , and b_Z are the bias correction factors.
- g_{11} , g_{12} , g_{13} , g_{21} , g_{22} , g_{23} , g_{31} , g_{32} , and g_{33} are the linear g correction factors.
- a'_X , a'_Y , and a'_Z are the postcalibration accelerometer data.

All the correction factors in each matrix/array are derived from direct observation of the response of each gyroscope to a variety of rotation rates at multiple temperatures across the calibration temperature range ($-40^\circ\text{C} \leq T_c \leq +85^\circ\text{C}$). These correction factors are stored in the flash memory bank, but they are not available for observation. Register CONFIG, Bit 7 provides an on/off control for the linear g compensation (see Table 148). See Figure 45 for more details on the user calibration options that are available for the gyroscopes.

Accelerometer Factory Calibration

The accelerometer factory calibration applies the following correction formulas to the data of each accelerometer:

$$\begin{bmatrix} a'_X \\ a'_Y \\ a'_Z \end{bmatrix} = \begin{bmatrix} m_{11} & m_{12} & m_{13} \\ m_{21} & m_{22} & m_{23} \\ m_{31} & m_{32} & m_{33} \end{bmatrix} \times \begin{bmatrix} a_X \\ a_Y \\ a_Z \end{bmatrix} + \begin{bmatrix} b_X \\ b_Y \\ b_Z \end{bmatrix} + \begin{bmatrix} 0 & p_{12} & p_{13} \\ p_{21} & 0 & p_{23} \\ p_{31} & p_{32} & 0 \end{bmatrix} \times \begin{bmatrix} \omega_{XC}^2 \\ \omega_{YC}^2 \\ \omega_{ZC}^2 \end{bmatrix} \tag{2}$$

where:

a'_X , a'_Y , and a'_Z are the postcalibration accelerometer data.

m_{11} , m_{12} , m_{13} , m_{21} , m_{22} , m_{23} , m_{31} , m_{32} , and m_{33} are the scale and alignment correction factors.

a_X , a_Y , and a_Z are the precalibration accelerometer data.

b_X , b_Y , and b_Z are the bias correction factors.

0 , p_{12} , p_{13} , p_{21} , p_{23} , p_{31} , and p_{32} are the point of percussion correction factors

ω_{XC}^2 , ω_{YC}^2 , and ω_{ZC}^2 are the postcalibration gyroscope data (squared).

All the correction factors in each matrix/array are derived from direct observation of the response of each accelerometer to a variety of inertial test conditions at multiple temperatures across the calibration temperature range ($-40^\circ\text{C} \leq T_c \leq +85^\circ\text{C}$). These correction factors are stored in the flash memory bank, but they are not available for observation. Register CONFIG, Bit 6 provides an on/off control for the point of percussion alignment (see Table 148). See Figure 46 for more details on the user calibration options that are available for the accelerometers.

Filtering

After calibration, the data of each inertial sensor passes through two digital filters, both of which have user configurable attributes: FIR and decimation (see Figure 25).



Figure 25. Inertial Sensor Filtering

The FIR filter includes four banks of coefficients that have 120 taps each. Register FILTR_BNK_0 (see Table 158) and Register FILTR_BNK_1 (see Table 160) provide the configuration options for the use of the FIR filters of each inertial sensor. Each FIR filter bank includes a preconfigured filter, but the user can design their own filters and write over these values using the register of each coefficient. For example, Table 163 provides the details for the FIR_COEF_A071 register, which contains Coefficient 71 in FIR Bank A. Refer to Figure 49 for the frequency response of the factory default filters. These filters do not represent any specific application environment; they are only examples.

The decimation filter averages multiple samples together to produce each register update. In this type of filter structure, the number of samples in the average is equal to the reduction in the update rate for the output data registers. See the DEC_RATE register for the user controls for this filter (see Table 150).

REGISTER STRUCTURE

All communication with the ADIS16497 involves accessing its user registers. The register structure contains both output data and control registers. The output data registers include the latest sensor data, error flags, and identification data. The control registers include sample rate, filtering, I/O, calibration, and diagnostic configuration options. All communication between the ADIS16497 and an external processor involves either reading or writing to one of the user registers.

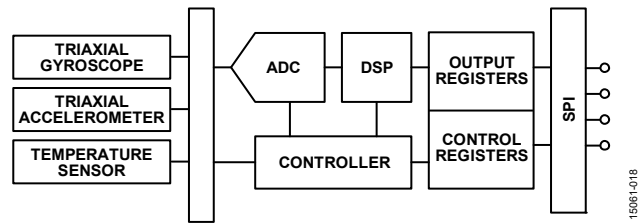
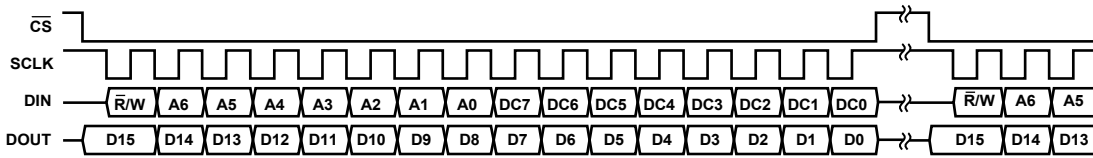

Figure 26. Basic Operation

The register structure uses a paged addressing scheme that contains 13 pages, with each page containing 64 register locations. Each register is 16 bits wide, with each byte having its own unique address within the memory map of that page. The SPI port has access to one page at a time, using the bit sequence in Figure 27. Select the page to activate for SPI access by writing its code to the PAGE_ID register. Read the PAGE_ID register to determine which page is currently active. Table 7 displays the PAGE_ID contents for each page and their basic functions. The PAGE_ID register is located at Address 0x00 on every page.

Table 7. User Register Page Assignments

Page	PAGE_ID	Function
0	0x00	Output data, clock, identification
1	0x01	Reserved
2	0x02	Calibration
3	0x03	Control: sample rate, filtering, I/O
4	0x04	Serial number, cyclic redundancy check (CRC) values
5	0x05	FIR Filter Bank A, Coefficient 0 to Coefficient 59
6	0x06	FIR Filter Bank A, Coefficient 60 to Coefficient 119
7	0x07	FIR Filter Bank B, Coefficient 0 to Coefficient 59
8	0x08	FIR Filter Bank B, Coefficient 60 to Coefficient 119
9	0x09	FIR Filter Bank C, Coefficient 0 to Coefficient 59
10	0x0A	FIR Filter Bank C, Coefficient 60 to Coefficient 119
11	0x0B	FIR Filter Bank D, Coefficient 0 to Coefficient 59
12	0x0C	FIR Filter Bank D, Coefficient 60 to Coefficient 119



- NOTES
1. DOUT BITS ARE PRODUCED ONLY WHEN THE PREVIOUS 16-BIT DIN SEQUENCE STARTS WITH $\bar{R}/W = 0$.
 2. WHEN CS IS HIGH, DOUT IS IN A THREE-STATE, HIGH IMPEDANCE MODE, WHICH ALLOWS MULTIFUNCTIONAL USE OF THE LINE FOR OTHER DEVICES.

Figure 27. SPI Communication Bit Sequence

15061-019

SERIAL PERIPHERAL INTERFACE

The SPI provides access to all of the user accessible registers (see Table 8) and typically connects to a compatible port on an embedded processor platform. See Figure 28 for a diagram that provides the most common connections between the ADIS16497 and an embedded processor.

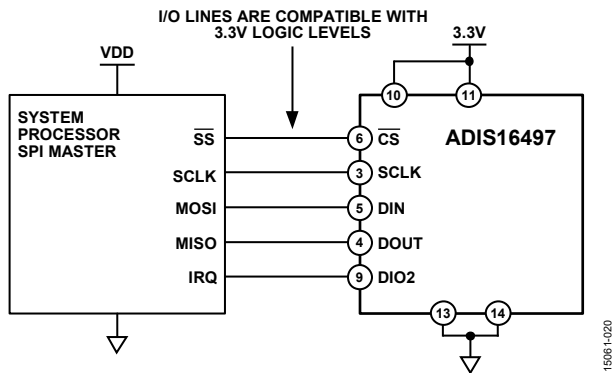

Figure 28. Electrical Connection Diagram

15061-020

Table 8. Generic Master Processor Pin Names and Functions

Mnemonic	Function
\overline{SS}	Slave select
IRQ	Interrupt request
MOSI	Master output, slave input
MISO	Master input, slave output
SCLK	Serial clock

Embedded processors typically use control registers to configure their serial ports for communicating with SPI slave devices such as the ADIS16497. Table 9 provides a list of settings that describe the SPI protocol of the ADIS16497. The initialization routine of the master processor typically establishes these settings using firmware commands to write them into its serial control registers.

Table 9. Generic Master Processor SPI Settings

Processor Setting	Description
Master	ADIS16497 operates as slave
$SCLK \leq 15$ MHz	Maximum serial clock rate
SPI Mode 3	CPOL = 1 (polarity), CPHA = 1 (phase)
MSB First Mode	Bit sequence, see Figure 27 for coding
16-Bit Mode	Shift register/data length

DATA READY

The factory default configuration provides the user with a data ready (DR) signal on the DIO2 pin, which pulses low when the output data registers are updating (see Figure 29). In this configuration, connect DIO2 to an interrupt service pin on the embedded processor, which triggers data collection, when this signal pulses high. Register FNCTIO_CTRL, Bits[3:0] (see Table 144), provides user configuration options for this function.

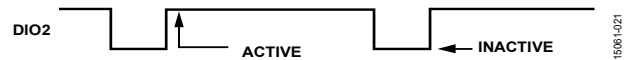

Figure 29. Data Ready, when FNCTIO_CTRL, Bits[3:0] = 1101 (default)

15061-021

During the start-up and reset recovery processes, the DR signal can exhibit transient behavior before data production begins. Figure 30 provides an example of the DR behavior during startup, and Figure 31 and Figure 32 provide examples of the DR behavior during recovery from reset commands.

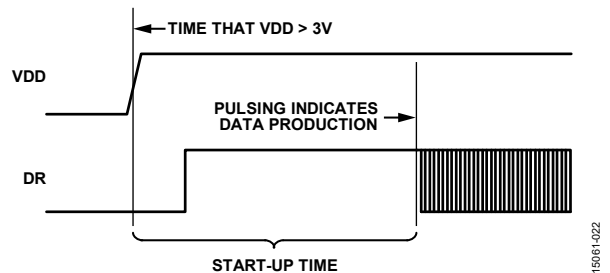

Figure 30. Data Ready Response During Startup

15061-022

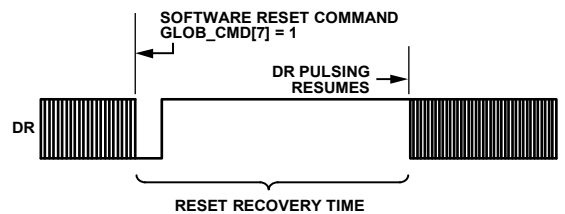

Figure 31. Data Ready Response During Software Reset (Register GLOB_CMD, Bit 7 = 1) Recovery

15061-023

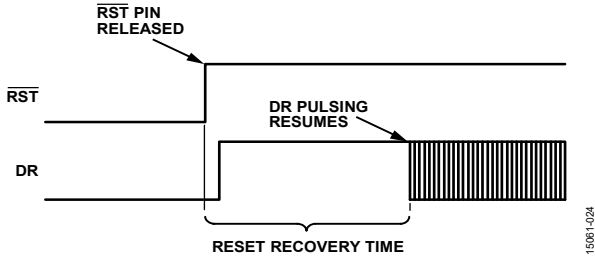

Figure 32. Data Ready Response During Reset ($\overline{\text{RST}} = 0$) Recovery

READING SENSOR DATA

Reading a single register requires two 16-bit cycles on the SPI: one to request the contents of a register and another to receive those contents. The 16-bit command code (see Figure 27) for a read request on the SPI has three parts: the read bit ($\overline{\text{R}}/\text{W} = 0$), the 7-bit address code for either address (upper or lower) of the register, Bits[A6:A0], and eight don't care bits, Bits[DC7:DC0]. Figure 33 provides an example that includes two register reads in succession. This example starts with $\text{DIN} = 0x1A00$, to request the contents of the Z_GYRO_OUT register, and follows with $0x1800$, to request the contents of the Z_GYRO_LOW register (assuming PAGE_ID already equals $0x0000$). The sequence in Figure 33 also shows full duplex mode of operation, which means that the ADIS16497 can receive requests on DIN while also transmitting data out on DOUT within the same 16-bit SPI cycle.



Figure 33. SPI Read Example

Figure 34 provides an example of the four SPI signals when reading the PROD_ID register (see Table 92) in a repeating pattern. This pattern can be helpful when troubleshooting the SPI interface setup and communications.

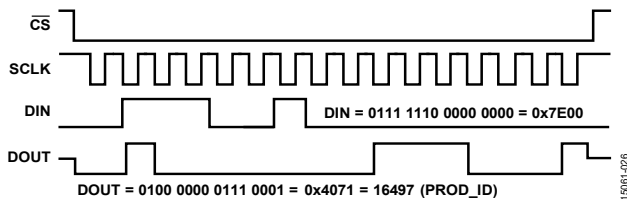

Figure 34. SPI Read Example, Second 16-Bit Sequence

Burst Read Function

The burst read function (BRF) provides a method for reading a batch of data (status, temperature, gyroscopes, accelerometers, time stamp/data counter, and CRC code), which does not require a stall time between each 16-bit segment and only requires one command on the DIN line to initiate. System processors can execute the BRF by reading the BURST_CMD register ($\text{DIN} = 0x7C00$) and then reading each segment of data in the response, while holding the $\overline{\text{CS}}$ line in a low state, until after reading the last 16-bit segment of data. If the $\overline{\text{CS}}$ line goes high before the completion of all data acquisition, the data from that read request is lost.

The BRF response (on the DOUT line) contains either 19 or 20 data segments (16-bits each), after the BRF request ($\text{DIN} = 0x7C00$) depending on the SCLK rate. Figure 5 and Table 10 illustrate the 19-segment case, while Figure 6 and in Table 11 illustrate the 20-segment case.

To manage that variation, use the transition from the BURST_ID code ($0xA5A5$ in Table 10 and Table 11) to the SYS_E_FLAG register, which is not equal to $0xA5A5$, as an identifier for when the ADIS16497 BRF response is starting.

Table 10. BRF Data Format ($f_{\text{SCLK}} < 3\ \text{MHz}$)¹

Segment	DIN	DOUT
0	0x7C00	N/A
1	N/A	0x0000
2	N/A	0xA5A5 (BURST_ID)
3	N/A	SYS_E_FLAG
4	N/A	TEMP_OUT
5	N/A	X_GYRO_LOW
6	N/A	X_GYRO_OUT
7	N/A	Y_GYRO_LOW
8	N/A	Y_GYRO_OUT
9	N/A	Z_GYRO_LOW
10	N/A	Z_GYRO_OUT
11	N/A	X_ACCL_LOW
12	N/A	X_ACCL_OUT
13	N/A	Y_ACCL_LOW
14	N/A	Y_ACCL_OUT
15	N/A	Z_ACCL_LOW
16	N/A	Z_ACCL_OUT
17	N/A	DATA_CNT (FNCTIO_CTRL, Bits[8:7] \neq 11) TIME_STAMP (FNCTIO_CTRL, Bits[8:7] = 11)
18	N/A	CRC_LWR
19	N/A	CRC_UPR

¹ N/A means not applicable.

Table 11. BRF Data Format ($f_{SCLK} > 3.6 \text{ MHz}$)¹

Segment	DIN	DOUT
0	0x7C00	N/A
1	N/A	0x0000
2	N/A	0xA5A5 (BURST_ID)
3	N/A	0xA5A5 (BURST_ID)
4	N/A	SYS_E_FLAG
5	N/A	TEMP_OUT
6	N/A	X_GYRO_LOW
7	N/A	X_GYRO_OUT
8	N/A	Y_GYRO_LOW
9	N/A	Y_GYRO_OUT
10	N/A	Z_GYRO_LOW
11	N/A	Z_GYRO_OUT
12	N/A	X_ACCL_LOW
13	N/A	X_ACCL_OUT
14	N/A	Y_ACCL_LOW
15	N/A	Y_ACCL_OUT
16	N/A	Z_ACCL_LOW
17	N/A	Z_ACCL_OUT
18	N/A	DATA_CNT (FNCTIO_CTRL, Bits[8:7] \neq 11) TIME_STAMP (FNCTIO_CTRL, Bits[8:7] = 11)
19	N/A	CRC_LWR
20	N/A	CRC_UPR

¹ N/A means not applicable.

DEVICE CONFIGURATION

Each register contains 16 bits (two bytes); Bits[7:0] contain the low byte and Bits[15:8] contain the high byte. Each byte has its own unique address in the user register map (see Table 12). Updating the contents of a register requires writing to its low byte first and its high byte second. There are three parts to coding a SPI command (see Figure 27), which writes a new byte of data to a register: the write bit ($\bar{R}/W = 1$), the 7-bit address code for the byte that this command is updating, and the new data for that location, Bits[DC7:DC0]. Figure 35 provides a coding example for writing 0xFEDC to the XG_BIAS_LOW register (see Table 106), assuming PAGE_ID already equals 0x0002.

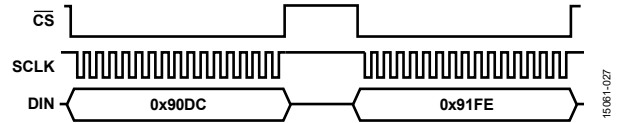

Figure 35. SPI Sequence for Writing 0xFEDC to XG_BIAS_LOW

Dual Memory Structure

The ADIS16497 uses a dual memory structure (see Figure 36), with static random access memory (SRAM) supporting real-time operation and flash memory storing operational code, calibration coefficients, and user configurable register settings. The manual flash update command (GLOB_CMD, Bit 3, see Table 142) provides a single-command method for storing user configuration settings into flash memory, for automatic recall during the next power-on or reset recovery process. This portion of the flash memory bank has two independent banks that operate in a ping pong manner, alternating with every flash update. During power-on or reset recovery, the ADIS16497 performs a CRC on the SRAM and compares it to a CRC computation from the same memory locations in flash memory. If this memory test fails, the ADIS16497 resets and boots up from the other flash memory location. SYS_E_FLAG, Bit 2 (see Table 18) provides an error flag for detecting when the backup flash memory supported the last power-on or reset recovery. Table 12 provides a memory map for the user registers in the ADIS16497, which includes flash backup support (indicated by yes or no in the flash column).

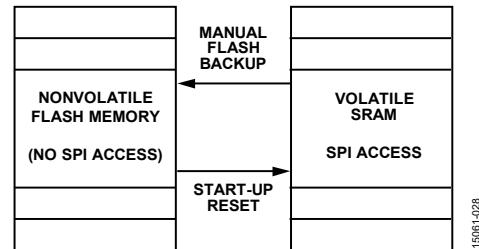

Figure 36. SRAM and Flash Memory Diagram

USER REGISTER MEMORY MAP

Table 12. User Register Memory Map¹

Register Name	R/W	Flash Backup	PAGE_ID	Address	Default	Register Description
PAGE_ID	R/W	No	0x00	0x00, 0x01	0x0000	Page identifier
Reserved	N/A	N/A	0x00	0x02, 0x03	N/A	Reserved
DATA_CNT	R	No	0x00	0x04, 0x05	N/A	Data counter
Reserved	N/A	N/A	0x00	0x06, 0x07	N/A	Reserved
SYS_E_FLAG	R	No	0x00	0x08, 0x09	N/A	Output, system error flags (0x0000 if no errors)
DIAG_STS	R	No	0x00	0x0A, 0x0B	N/A	Output, self test error flags (0x0000 if no errors)
Reserved	N/A	N/A	0x00	0x0C, 0x0D	N/A	Reserved
TEMP_OUT	R	No	0x00	0x0E, 0x0F	N/A	Output, temperature
X_GYRO_LOW	R	No	0x00	0x10, 0x11	N/A	Output, x-axis gyroscope, low word
X_GYRO_OUT	R	No	0x00	0x12, 0x13	N/A	Output, x-axis gyroscope, high word
Y_GYRO_LOW	R	No	0x00	0x14, 0x15	N/A	Output, y-axis gyroscope, low word
Y_GYRO_OUT	R	No	0x00	0x16, 0x17	N/A	Output, y-axis gyroscope, high word
Z_GYRO_LOW	R	No	0x00	0x18, 0x19	N/A	Output, z-axis gyroscope, low word
Z_GYRO_OUT	R	No	0x00	0x1A, 0x1B	N/A	Output, z-axis gyroscope, high word
X_ACCL_LOW	R	No	0x00	0x1C, 0x1D	N/A	Output, x-axis accelerometer, low word
X_ACCL_OUT	R	No	0x00	0x1E, 0x1F	N/A	Output, x-axis accelerometer, high word
Y_ACCL_LOW	R	No	0x00	0x20, 0x21	N/A	Output, y-axis accelerometer, low word
Y_ACCL_OUT	R	No	0x00	0x22, 0x23	N/A	Output, y-axis accelerometer, high word
Z_ACCL_LOW	R	No	0x00	0x24, 0x25	N/A	Output, z-axis accelerometer, low word
Z_ACCL_OUT	R	No	0x00	0x26, 0x27	N/A	Output, z-axis accelerometer, high word
TIME_STAMP	R	No	0x00	0x28, 0x29	N/A	Output, time stamp
CRC_LWR	R	No	0x00	0x2A, 0x2B	N/A	Output, CRC-32 (32 bits), lower word
CRC_UPR	R	No	0x00	0x2C, 0x2D	N/A	Output, CRC-32, upper word
Reserved	N/A	N/A	0x00	0x2E to 0x3F	N/A	Reserved
X_DELTANG_LOW	R	No	0x00	0x40, 0x41	N/A	Output, x-axis delta angle, low word
X_DELTANG_OUT	R	No	0x00	0x42, 0x43	N/A	Output, x-axis delta angle, high word
Y_DELTANG_LOW	R	No	0x00	0x44, 0x45	N/A	Output, y-axis delta angle, low word
Y_DELTANG_OUT	R	No	0x00	0x46, 0x47	N/A	Output, y-axis delta angle, high word
Z_DELTANG_LOW	R	No	0x00	0x48, 0x49	N/A	Output, z-axis delta angle, low word
Z_DELTANG_OUT	R	No	0x00	0x4A, 0x4B	N/A	Output, z-axis delta angle, high word
X_DELTVEL_LOW	R	No	0x00	0x4C, 0x4D	N/A	Output, x-axis delta velocity, low word
X_DELTVEL_OUT	R	No	0x00	0x4E, 0x4F	N/A	Output, x-axis delta velocity, high word
Y_DELTVEL_LOW	R	No	0x00	0x50, 0x51	N/A	Output, y-axis delta velocity, low word
Y_DELTVEL_OUT	R	No	0x00	0x52, 0x53	N/A	Output, y-axis delta velocity, high word
Z_DELTVEL_LOW	R	No	0x00	0x54, 0x55	N/A	Output, z-axis delta velocity, low word
Z_DELTVEL_OUT	R	No	0x00	0x56, 0x57	N/A	Output, z-axis delta velocity, high word
Reserved	N/A	N/A	0x00	0x58 to 0x7B	N/A	Reserved
BURST_CMD	R	No	0x00	0x7C, 0x7D	N/A	Burst-read command
PROD_ID	R	Yes	0x00	0x7E, 0x7F	0x4071	Output, product identification (16497d)
Reserved	N/A	N/A	0x01	0x00 to 0x7F	N/A	Reserved
PAGE_ID	R/W	No	0x02	0x00, 0x01	0x0000	Page identifier
Reserved	N/A	N/A	0x02	0x02, 0x03	N/A	Reserved
X_GYRO_SCALE	R/W	Yes	0x02	0x04, 0x05	0x0000	Calibration, scale, x-axis gyroscope
Y_GYRO_SCALE	R/W	Yes	0x02	0x06, 0x07	0x0000	Calibration, scale, y-axis gyroscope
Z_GYRO_SCALE	R/W	Yes	0x02	0x08, 0x09	0x0000	Calibration, scale, z-axis gyroscope
X_ACCL_SCALE	R/W	Yes	0x02	0x0A, 0x0B	0x0000	Calibration, scale, x-axis accelerometer
Y_ACCL_SCALE	R/W	Yes	0x02	0x0C, 0x0D	0x0000	Calibration, scale, y-axis accelerometer
Z_ACCL_SCALE	R/W	Yes	0x02	0x0E, 0x0F	0x0000	Calibration, scale, z-axis accelerometer
XG_BIAS_LOW	R/W	Yes	0x02	0x10, 0x11	0x0000	Calibration, bias, gyroscope, x-axis, low word
XG_BIAS_HIGH	R/W	Yes	0x02	0x12, 0x13	0x0000	Calibration, bias, gyroscope, x-axis, high word

Register Name	R/W	Flash Backup	PAGE_ID	Address	Default	Register Description
YG_BIAS_LOW	R/W	Yes	0x02	0x14, 0x15	0x0000	Calibration, bias, gyroscope, y-axis, low word
YG_BIAS_HIGH	R/W	Yes	0x02	0x16, 0x17	0x0000	Calibration, bias, gyroscope, y-axis, high word
ZG_BIAS_LOW	R/W	Yes	0x02	0x18, 0x19	0x0000	Calibration, bias, gyroscope, z-axis, low word
ZG_BIAS_HIGH	R/W	Yes	0x02	0x1A, 0x1B	0x0000	Calibration, bias, gyroscope, z-axis, high word
XA_BIAS_LOW	R/W	Yes	0x02	0x1C, 0x1D	0x0000	Calibration, bias, accelerometer, x-axis, low word
XA_BIAS_HIGH	R/W	Yes	0x02	0x1E, 0x1F	0x0000	Calibration, bias, accelerometer, x-axis, high word
YA_BIAS_LOW	R/W	Yes	0x02	0x20, 0x21	0x0000	Calibration, bias, accelerometer, y-axis, low word
YA_BIAS_HIGH	R/W	Yes	0x02	0x22, 0x23	0x0000	Calibration, bias, accelerometer, y-axis, high word
ZA_BIAS_LOW	R/W	Yes	0x02	0x24, 0x25	0x0000	Calibration, bias, accelerometer, z-axis, low word
ZA_BIAS_HIGH	R/W	Yes	0x02	0x26, 0x27	0x0000	Calibration, bias, accelerometer, z-axis, high word
Reserved	N/A	N/A	0x02	0x28 to 0x73	0x0000	Reserved
USER_SCR_1	R/W	Yes	0x02	0x74, 0x75	0x0000	User Scratch Register 1
USER_SCR_2	R/W	Yes	0x02	0x76, 0x77	0x0000	User Scratch Register 2
USER_SCR_3	R/W	Yes	0x02	0x78, 0x79	0x0000	User Scratch Register 3
USER_SCR_4	R/W	Yes	0x02	0x7A, 0x7B	0x0000	User Scratch Register 4
FLSHCNT_LOW	R	Yes	0x02	0x7C, 0x7D	N/A	Diagnostic, flash memory count, low word
FLSHCNT_HIGH	R	Yes	0x02	0x7E, 0x7F	N/A	Diagnostic, flash memory count, high word
PAGE_ID	R/W	No	0x03	0x00, 0x01	0x0000	Page identifier
GLOB_CMD	W	No	0x03	0x02, 0x03	N/A	Control, global commands
Reserved	N/A	N/A	0x03	0x04, 0x05	N/A	Reserved
FNCTIO_CTRL	R/W	Yes	0x03	0x06, 0x07	0x000D	Control, I/O pins, functional definitions
GPIO_CTRL	R/W	Yes	0x03	0x08, 0x09	0x00X0 ²	Control, I/O pins, general-purpose
CONFIG	R/W	Yes	0x03	0x0A, 0x0B	0x00C0	Control, clock, and miscellaneous correction
DEC_RATE	R/W	Yes	0x03	0x0C, 0x0D	0x0000	Control, output sample rate decimation
NULL_CNFG	R/W	Yes	0x03	0x0E, 0x0F	0x070A	Control, automatic bias correction configuration
SYNC_SCALE	R/W	Yes	0x03	0x10, 0x11	0x109A	Control, input clock scaling (PPS mode)
RANG_MDL	R	N/A	0x03	0x12, 0x13	N/A	Measurement range (model-specific) Identifier
Reserved	N/A	N/A	0x03	0x14, 0x15	N/A	Reserved
FILTR_BNK_0	R/W	Yes	0x03	0x16, 0x17	0x0000	Filter selection
FILTR_BNK_1	R/W	Yes	0x03	0x18, 0x19	0x0000	Filter selection
Reserved	N/A	N/A	0x03	0x1A to 0x77	N/A	Reserved
FIRM_REV	R	Yes	0x03	0x78, 0x79	N/A	Firmware revision
FIRM_DM	R	Yes	0x03	0x7A, 0x7B	N/A	Firmware programming date (day/month)
FIRM_Y	R	Yes	0x03	0x7C, 0x7D	N/A	Firmware programming date (year)
BOOT_REV	R	Yes	0x03	0x7E, 0x7F	N/A	Boot loader revision
PAGE_ID	R/W	No	0x04	0x00, 0x01	0x0000	Page identifier
Reserved	N/A	N/A	0x04	0x02, 0x03	N/A	Reserved
CAL_SIGTR_LWR	R	Yes	0x04	0x04, 0x05	N/A	Signature CRC, calibration coefficients, low word
CAL_SIGTR_UPR	R	Yes	0x04	0x06, 0x07	N/A	Signature CRC, calibration coefficients, high word
CAL_DRVTN_LWR	R	No	0x04	0x08, 0x09	N/A	Real-time CRC, calibration coefficients, low word
CAL_DRVTN_UPR	R	No	0x04	0x0A, 0x0B	N/A	Real-time CRC, calibration coefficients, high word
CODE_SIGTR_LWR	R	Yes	0x04	0x0C, 0x0D	N/A	Signature CRC, program code, low word
CODE_SIGTR_UPR	R	Yes	0x04	0x0E, 0x0F	N/A	Signature CRC, program code, high word
CODE_DRVTN_LWR	R	No	0x04	0x10, 0x11	N/A	Real-time CRC, program code, low word
CODE_DRVTN_UPR	R	No	0x04	0x12, 0x13	N/A	Real-time CRC, program code, high word
Reserved	N/A	N/A	0x04	0x14 to 0x1F	N/A	Reserved
SERIAL_NUM	R	Yes	0x04	0x20, 0x21	N/A	Serial number
Reserved	N/A	N/A	0x04	0x22 to 0x7F	N/A	Reserved
PAGE_ID	R/W	No	0x05	0x00, 0x01	0x0000	Page identifier
Reserved	N/A	N/A	0x05	0x02 to 0x07	N/A	Reserved
FIR_COEF_Axxx ³	R/W	Yes	0x05	0x08 to 0x7F	N/A	FIR Filter Bank A: Coefficient 0 through Coefficient 59
PAGE_ID	R/W	No	0x06	0x00, 0x01	0x0000	Page identifier
Reserved	N/A	N/A	0x06	0x02 to 0x07	N/A	Reserved

Register Name	R/W	Flash Backup	PAGE_ID	Address	Default	Register Description
FIR_COEF_Axxx ³	R/W	Yes	0x06	0x08 to 0x7F	N/A	FIR Filter Bank A: Coefficient 60 through Coefficient 119
PAGE_ID	R/W	No	0x07	0x00, 0x01	0x0000	Page identifier
Reserved	N/A	N/A	0x07	0x02 to 0x07	N/A	Reserved
FIR_COEF_Bxxx ⁴	R/W	Yes	0x07	0x08 to 0x7F	N/A	FIR Filter Bank B: Coefficient 0 through Coefficient 59
PAGE_ID	R/W	No	0x08	0x00, 0x01	0x0000	Page identifier
Reserved	N/A	N/A	0x08	0x02 to 0x07	N/A	Reserved
FIR_COEF_Bxxx ⁴	R/W	Yes	0x08	0x08 to 0x7F	N/A	FIR Filter Bank B: Coefficient 60 through Coefficient 119
PAGE_ID	R/W	No	0x09	0x00, 0x01	0x0000	Page identifier
Reserved	N/A	N/A	0x09	0x02 to 0x07	N/A	Reserved
FIR_COEF_Cxxx ⁵	R/W	Yes	0x09	0x08 to 0x7F	N/A	FIR Filter Bank C: Coefficient 0 through Coefficient 59
PAGE_ID	R/W	No	0x0A	0x00, 0x01	0x0000	Page identifier
Reserved	N/A	N/A	0x0A	0x02 to 0x07	N/A	Reserved
FIR_COEF_Cxxx ⁵	R/W	Yes	0x0A	0x08 to 0x7F	N/A	FIR Filter Bank C: Coefficient 60 through Coefficient 119
PAGE_ID	R/W	No	0x0B	0x00, 0x01	0x0000	Page identifier
Reserved	N/A	N/A	0x0B	0x02 to 0x07	N/A	Reserved
FIR_COEF_Dxxx ⁶	R/W	Yes	0x0B	0x08 to 0x7F	N/A	FIR Filter Bank D: Coefficient 0 through Coefficient 59
PAGE_ID	R/W	No	0x0C	0x00, 0x01	0x0000	Page identifier
Reserved	N/A	N/A	0x0C	0x02 to 0x07	N/A	Reserved
FIR_COEF_Dxxx ⁶	R/W	Yes	0x0C	0x08 to 0x7F	N/A	FIR Filter Bank D: Coefficient 60 through Coefficient 119

¹ N/A means not applicable.

² The GPIO_CTRL[7:4] bits reflect the logic levels on the DIOx lines and do not have a default setting.

³ See the FIR Filter Bank A, FIR_COEF_A000 to FIR_COEF_A119 section for additional information.

⁴ See the FIR Filter Bank B, FIR_COEF_B000 to FIR_COEF_B119 section for additional information.

⁵ See the FIR Filter Bank C, FIR_COEF_C000 to FIR_COEF_C119 section for additional information.

⁶ See the FIR Filter Bank D, FIR_COEF_D000 to FIR_COEF_D119 section for additional information.

USER REGISTER DEFINITIONS

PAGE NUMBER (PAGE_ID)

The contents in the PAGE_ID register (see Table 13 and Table 14) contain the current page setting, and provide a control for selecting another page for SPI access. For example, set DIN = 0x8002 to select Page 2 for SPI-based user access. See Table 12 for the page assignments associated with each user accessible register.

Table 13. PAGE_ID Register Definition

Page	Addresses	Default	Access	Flash Backup
0x00	0x00, 0x01	0x0000	R/W	No

Table 14. PAGE_ID Bit Descriptions

Bits	Description
[15:0]	Page number, binary numerical format

DATA/SAMPLE COUNTER (DATA_CNT)

The DATA_CNT register (see Table 15 and Table 16) is a continuous, real-time, sample counter. It starts at 0x0000, increments every time the output data registers update, and wraps around from 0xFFFF (65,535 decimal) to 0x0000 (0 decimal).

Table 15. DATA_CNT Register Definition

Page	Addresses	Default	Access	Flash Backup
0x00	0x04, 0x05	Not applicable	R	No

Table 16. DATA_CNT Bit Descriptions

Bits	Description
[15:0]	Data counter, binary format

STATUS/ERROR FLAG INDICATORS (SYS_E_FLAG)

The SYS_E_FLAG register (see Table 17 and Table 18) provides various error flags. Reading this register causes all of its bits to return to 0, with the exception of Bit 7. If an error condition persists, its flag (bit) automatically returns to an alarm value of 1.

Table 17. SYS_E_FLAG Register Definition

Page	Addresses	Default	Access	Flash Backup
0x00	0x08, 0x09	0x0000	R	No

Table 18. SYS_E_FLAG Bit Descriptions

Bits	Description
15	Watchdog timer flag. A 1 indicates the ADIS16497 automatically resets itself to clear an issue.
[14:9]	Not used.
8	Sync error. A 1 indicates the sample timing is not scaling correctly, when operating in PPS mode (FNCTIO_CTRL, Bit 8 = 1, see Table 144). When this error occurs, verify that the input sync frequency is correct and that SYNC_SCALE (see Table 154) has the correct value.
7	Processing overrun. A 1 indicates the occurrence of a processing overrun. Initiate a reset to recover. Replace the ADIS16497 if this error persists.
6	Flash memory update failure. A 1 indicates that the most recent flash memory update failed (GLOB_CMD, Bit 3, see Table 142). Repeat the test and replace the ADIS16497 if this error persists.
5	Sensor failure. A 1 indicates failure in at least one of the inertial sensors. Read the DIAG_STS register (see Table 20) to determine which sensor is failing. Replace the ADIS16497 if the error persists, when it is operating in static inertial conditions.
4	Not used.
3	SPI communication error. A 1 indicates that the total number of SCLK cycles is not equal to an integer multiple of 16. Repeat the previous communication sequence to recover. Persistence in this error can indicate a weakness in the SPI service from the master processor.
2	SRAM error condition. A 1 indicates a failure in the CRC (period = 20 ms) between the SRAM and flash memory. Initiate a reset to recover. Replace the ADIS16497 if this error persists.
1	Boot memory failure. A 1 indicates that the device booted up using code from the backup memory bank. Replace the ADIS16497 if this error occurs.
0	Not used.

SELF TEST ERROR FLAGS (DIAG_STS)

SYS_E_FLAG, Bit 5 (see Table 18) contains the pass/fail result (0 = pass) for the on demand self test (ODST) operations, whereas the DIAG_STS register (see Table 19 and Table 20) contains pass/fail flags (0 = pass) for each inertial sensor. Reading the DIAG_STS register causes all of its bits to restore to 0. The bits in DIAG_STS return to 1 if the error conditions persists.

Table 19. DIAG_STS Register Definition

Page	Addresses	Default	Access	Flash Backup
0x00	0x0A, 0x0B	0x0000	R	No

Table 20. DIAG_STS Bit Descriptions

Bits	Description (Default = 0x0000)
[15:6]	Not used
5	Self test failure, z-axis accelerometer (1 means failure)
4	Self test failure, y-axis accelerometer (1 means failure)
3	Self test failure, x-axis accelerometer (1 means failure)
2	Self test failure, z-axis gyroscope (1 means failure)
1	Self test failure, y-axis gyroscope (1 means failure)
0	Self test failure, x-axis gyroscope (1 means failure)

INTERNAL TEMPERATURE (TEMP_OUT)

The TEMP_OUT register (see Table 21 and Table 22) provides a coarse measurement of the temperature inside of the ADIS16497, and is useful for monitoring relative changes in the thermal environment. Table 23 provides several examples of the data format for the TEMP_OUT register.

Table 21. TEMP_OUT Register Definition

Page	Addresses	Default	Access	Flash Backup
0x00	0x0E, 0x0F	Not applicable	R	No

Table 22. TEMP_OUT Bit Definitions

Bits	Description
[15:0]	Temperature data; twos complement, 1°C per 80 LSB, 25°C = 0x0000

Table 23. TEMP_OUT Data Format Examples

Temperature (°C)	Decimal	Hex	Binary
+85	+4800	0x12C0	0001 0010 1100 0000
+25 + 2/80	+2	0x0002	0000 0000 0000 0010
+25 + 1/80	+1	0x0001	0000 0000 0000 0001
+25	0	0x0000	0000 0000 0000 0000
+25 - 1/80	-1	0xFFFF	1111 1111 1111 1111
+25 - 2/80	-2	0xFFFE	1111 1111 1111 1110
-40	-5200	0xEBB0	1110 1011 1011 0000

GYROSCOPE DATA

The gyroscopes in the ADIS16497 measure the angular rate of rotation around three orthogonal axes (x, y, and z). Figure 38 shows the orientation of each gyroscope axis, which defines the direction of rotation that produces a positive response in each of the angular rate measurements.

Each gyroscope has two output data registers. Figure 37 shows how these two registers combine to support a 32-bit, twos complement data format for the x-axis gyroscope measurements. This format also applies to the y-axis and z-axis as well.

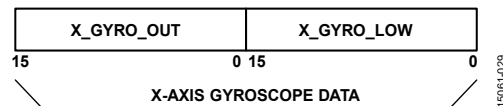

Figure 37. Gyroscope Output Data Structure

Gyroscope Measurement Range/Scale Factor

Table 24 provides the range and scale factor (K_G) for the angular rate (gyroscope) measurements in each ADIS16497 model.

Table 24. Gyroscope Measurement Range and Scale Factors

Model	Range	Scale Factor, K _G
ADIS16497-1	±125°/sec	0.00625°/sec/LSB
ADIS16497-2	±450°/sec	0.025°/sec/LSB
ADIS16497-3	±2000°/sec	0.1°/sec/LSB

Gyroscope Data Formatting

Table 25 and Table 26 offer various numerical examples that demonstrate the format of the rotation rate data in both 16-bit and 32-bit formats. See Table 24 for the scale factor (K_G) associated with each ADIS16497 model.

Table 25. 16-Bit Gyroscope Data Format Examples

Rotation Rate (°/sec)	Decimal	Hex	Binary
+10000 K _G	+10,000	0x2710	0010 0111 0001 0000
+2 K _G	+2	0x0002	0000 0000 0000 0010
+K _G	+1	0x0001	0000 0000 0000 0001
0°/sec	0	0x0000	0000 0000 0000 0000
-K _G	-1	0xFFFF	1111 1111 1111 1111
-2 K _G	-2	0xFFFE	1111 1111 1111 1110
-10000 K _G	-10,000	0xD8F0	1101 1000 1111 0000

Table 26. 32-Bit Gyroscope Data Format Examples

Rotation Rate (°/sec)	Decimal	Hexadecimal
+10000 K _G	+655,360,000	0x27100000
+K _G /2 ¹⁵	+2	0x00000002
+K _G /2 ¹⁶	+1	0x00000001
0	0	0x00000000
-K _G /2 ¹⁶	-1	0xFFFFFFF
-K _G /2 ¹⁵	-2	0xFFFFFFF
-10000 K _G	-655,360,000	0xD8F00000

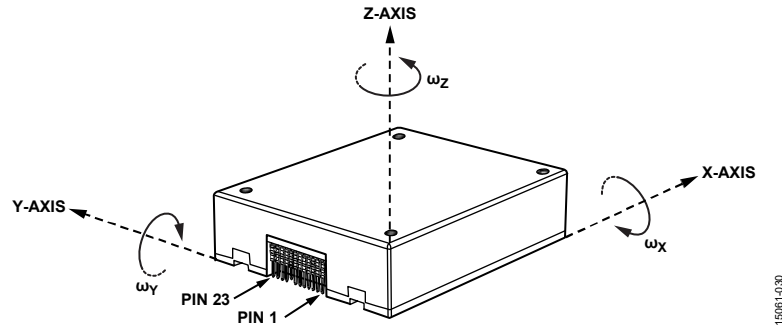

Figure 38. Gyroscope Axis and Polarity Assignments

X-Axis Gyroscope (X_GYRO_LOW, X_GRYO_OUT)

The X_GYRO_LOW (see Table 27 and Table 28) and X_GRYO_OUT (see Table 29 and Table 30) registers contain the gyroscope data for the x-axis.

Table 27. X_GYRO_LOW Register Definition

Page	Addresses	Default	Access	Flash Backup
0x00	0x10, 0x11	Not applicable	R	No

Table 28. X_GYRO_LOW Bit Descriptions

Bits	Description
[15:0]	X-axis gyroscope data; low word

Table 29. X_GYRO_OUT Register Definition

Page	Addresses	Default	Access	Flash Backup
0x00	0x12, 0x13	Not applicable	R	No

Table 30. X_GYRO_OUT Bit Descriptions

Bits	Description
[15:0]	X-axis gyroscope data; high word; twos complement, 0°/sec = 0x0000, see Table 24 for scale factor

Y-Axis Gyroscope (Y_GYRO_LOW, Y_GYRO_OUT)

The Y_GYRO_LOW (see Table 31 and Table 32) and Y_GRYO_OUT (see Table 33 and Table 34) registers contain the gyroscope data for the y-axis.

Table 31. Y_GYRO_LOW Register Definition

Page	Addresses	Default	Access	Flash Backup
0x00	0x14, 0x15	Not applicable	R	No

Table 32. Y_GYRO_LOW Bit Descriptions

Bits	Description
[15:0]	Y-axis gyroscope data; low word

Table 33. Y_GYRO_OUT Register Definition

Page	Addresses	Default	Access	Flash Backup
0x00	0x16, 0x17	Not applicable	R	No

Table 34. Y_GYRO_OUT Bit Descriptions

Bits	Description
[15:0]	Y-axis gyroscope data; high word; twos complement, 0°/sec = 0x0000, see Table 24 for scale factor

Z-Axis Gyroscope (Z_GYRO_LOW, Z_GYRO_OUT)

The Z_GYRO_LOW (see Table 35 and Table 36) and Z_GRYO_OUT (see Table 37 and Table 38) registers contain the gyroscope data for the z-axis.

Table 35. Z_GYRO_LOW Register Definition

Page	Addresses	Default	Access	Flash Backup
0x00	0x18, 0x19	Not applicable	R	No

Table 36. Z_GYRO_LOW Bit Descriptions

Bits	Description
[15:0]	Z-axis gyroscope data; additional resolution bits

Table 37. Z_GYRO_OUT Register Definition

Page	Addresses	Default	Access	Flash Backup
0x00	0x1A, 0x1B	Not applicable	R	No

Table 38. Z_GYRO_OUT Bit Descriptions

Bits	Description
[15:0]	Z-axis gyroscope data; high word; twos complement, 0°/sec = 0x0000, see Table 24 for scale factor

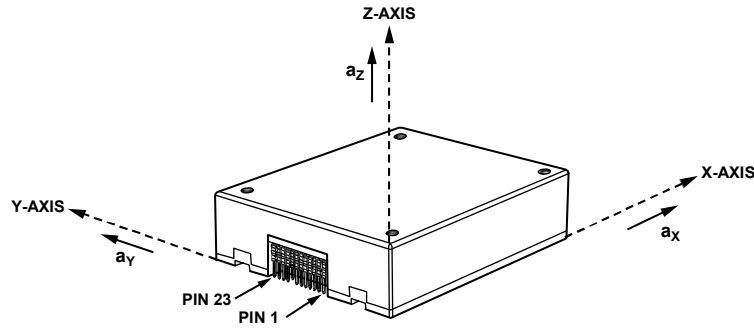

Figure 39. Accelerometer Axis and Polarity Assignments

ACCELERATION DATA

The accelerometers in the ADIS16497 measure both dynamic and static (response to gravity) acceleration along three orthogonal axes (x, y, and z). Figure 39 shows the orientation of each accelerometer axis, which defines the direction of linear acceleration that produces a positive response in each of the angular rate measurements.

Each accelerometer has two output data registers. Figure 40 shows how these two registers combine to support a 32-bit, twos complement data format for the x-axis accelerometer measurements. This format also applies to the y-axis and z-axis.

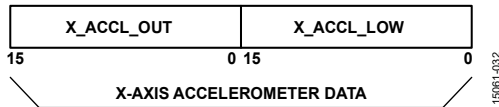

Figure 40. Accelerometer Output Data Structure

X-Axis Accelerometer (X_ACCL_LOW, X_ACCL_OUT)

The X_ACCL_LOW (see Table 39 and Table 40) and X_ACCL_OUT (see Table 41 and Table 42) registers contain the accelerometer data for the x-axis.

Table 39. X_ACCL_LOW Register Definition

Page	Addresses	Default	Access	Flash Backup
0x00	0x1C, 0x1D	Not applicable	R	No

Table 40. X_ACCL_LOW Bit Descriptions

Bits	Description
[15:0]	X-axis accelerometer data; low word

Table 41. X_ACCL_OUT Register Definition

Page	Addresses	Default	Access	Flash Backup
0x00	0x1E, 0x1F	Not applicable	R	No

Table 42. X_ACCL_OUT Descriptions

Bits	Description
[15:0]	X-axis accelerometer data, high word; twos complement, $\pm 40 g$ range; $0 g = 0x0000$, 1 LSB = 1.25 mg

Y-Axis Accelerometer (Y_ACCL_LOW, Y_ACCL_OUT)

The Y_ACCL_LOW (see Table 43 and Table 44) and Y_ACCL_OUT (see Table 45 and Table 46) registers contain the accelerometer data for the y-axis.

Table 43. Y_ACCL_LOW Register Definition

Page	Addresses	Default	Access	Flash Backup
0x00	0x20, 0x21	Not applicable	R	No

Table 44. Y_ACCL_LOW Bit Descriptions

Bits	Description
[15:0]	Y-axis accelerometer data; low word

Table 45. Y_ACCL_OUT Register Definition

Page	Addresses	Default	Access	Flash Backup
0x00	0x22, 0x23	Not applicable	R	No

Table 46. Y_ACCL_OUT Bit Descriptions

Bits	Description
[15:0]	Y-axis accelerometer data, high word; twos complement, $\pm 40 g$ range; $0 g = 0x0000$, 1 LSB = 1.25 mg

Z-Axis Accelerometer (Z_ACCL_LOW, Z_ACCL_OUT)

The Z_ACCL_LOW (see Table 47 and Table 48) and Z_ACCL_OUT (see Table 49 and Table 50) registers contain the accelerometer data for the z-axis.

Table 47. Z_ACCL_LOW Register Definition

Page	Addresses	Default	Access	Flash Backup
0x00	0x24, 0x25	Not applicable	R	No

Table 48. Z_ACCL_LOW Bit Descriptions

Bits	Description
[15:0]	Z-axis accelerometer data; low word

Table 49. Z_ACCL_OUT Register Definition

Page	Addresses	Default	Access	Flash Backup
0x00	0x26, 0x27	Not applicable	R	No

Table 50. Z_ACCL_OUT Bit Descriptions

Bits	Description
[15:0]	Z-axis accelerometer data, high word; twos complement, $\pm 40 g$ range; $0 g = 0x0000$, 1 LSB = 1.25 mg

Accelerometer Resolution

Table 51 and Table 52 offer various numerical examples that demonstrate the format of the linear acceleration data in both 16-bit and 32-bit formats.

Table 51. 16-Bit Accelerometer Data Format Examples

Acceleration	Decimal	Hex	Binary
+40 g	+32,000	0x7D00	0111 1101 0000 0000
+2.5 mg	+2	0x0002	0000 0000 0000 0010
+1.25 mg	+1	0x0001	0000 0000 0000 0001
0 mg	0	0x0000	0000 0000 0000 0000
-1.25 mg	-1	0xFFFF	1111 1111 1111 1111
-2.5 mg	-2	0xFFFE	1111 1111 1111 1110
-40 g	-32,000	0x8300	1000 0011 0000 0000

Table 52. 32-Bit Accelerometer Data Format Examples

Acceleration	Decimal	Hexadecimal
+40 g	+2,097,152,000	0x7D000000
+1.25/2 ¹⁵ mg	+2	0x00000002
+1.25/2 ¹⁶ mg	+1	0x00000001
0 mg	0	0x00000000
-1.25/2 ¹⁶ mg	-1	0xFFFFFFFF
-1.25/2 ¹⁵ mg	-2	0xFFFFFFFF
-40 g	-2,097,152,000	0x83000000

TIME STAMP

When using PPS mode (FNCTIO_CTRL, Bits[8:7] = 11 (binary), see Table 144), the TIME_STAMP register (see Table 53 and Table 54) provides the time between the most recent pulse on the input clock signal and the most recent data update.

Table 53. TIME_STAMP Register Definition

Page	Addresses	Default	Access	Flash Backup
0x00	0x28, 0x29	Not applicable	R	No

Table 54. TIME_STAMP Bit Descriptions

Bits	Description
[15:0]	Time stamp, binary format. 1 LSB = 1/f _{SM} (see Figure 22, Figure 23, and Table 154). The leading edge of the input clock pulse resets the value in this register to 0x0000.

When using the decimation filter (DEC_RATE > 0x0000) the value in the TIME_STAMP register represents the time of the first sample (taken at the rate of f_{SM}, per Figure 22 and Figure 23). For example, when DEC_RATE = 0x0003, the decimation filter reduces the update by a factor of four and the TIME_STAMP register updates to 1 (decimal) during the first data update, then to 5 on the second update, 9 on the third update, for example; until the next clock signal pulse.

CYCLICAL REDUNDANCY CHECK (CRC-32)

The ADIS16497 performs a CRC-32 computation, using the data registers that are shown in Table 55.

Table 55. CRC-32 Source Data and Example Values

Register	Example Value
SYS_E_FLAG	0x0000
TEMP_OUT	0x083A
X_GYRO_LOW	0x0000
X_GYRO_OUT	0xFFF7
Y_GYRO_LOW	0x0000
Y_GYRO_OUT	0xFFFE
Z_GYRO_LOW	0x0000
Z_GYRO_OUT	0x0001
X_ACCL_LOW	0x5001
X_ACCL_OUT	0x0003
Y_ACCL_LOW	0xE00A
Y_ACCL_OUT	0x0015
Z_ACCL_LOW	0xC009
Z_ACCL_OUT	0x0320
TIME_STAMP	0x8A54

The CRC_LWR (see Table 56 and Table 57) and CRC_UPR (see Table 58 and Table 59) registers contain the result of the CRC-32 computation. For the example, the register values from Table 55 are,

$$CRC_LWR = 0x15B4$$

$$CRC_UPR = 0xB6C8$$

Table 56. CRC_LWR Register Definition

Page	Addresses	Default	Access	Flash Backup
0x00	0x2A, 0x2B	Not applicable	R	No

Table 57. CRC_LWR Bit Descriptions

Bits	Description
[15:0]	CRC-32 code from most recent BRG, lower word

Table 58. CRC_UPR Register Definition

Page	Addresses	Default	Access	Flash Backup
0x00	0x2C, 0x2D	Not applicable	R	No

Table 59. CRC_UPR Bit Descriptions

Bits	Description
[15:0]	CRC-32 code from most recent BRG, upper word

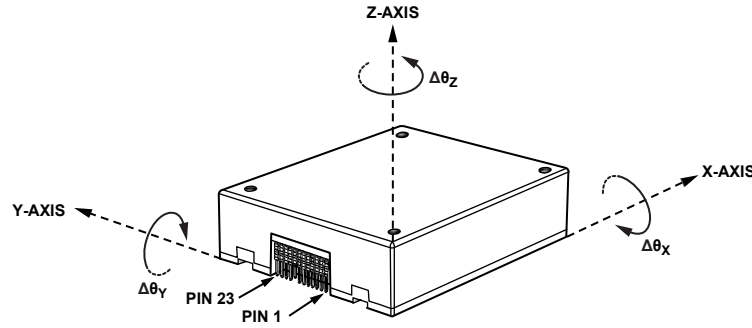

Figure 41. Delta Angle Axis and Polarity Assignments

DELTA ANGLES

In addition to the angular rate of rotation (gyroscope) measurements around each axis (x, y, and z), the ADIS16497 also provides delta angle measurements that represent a computation of angular displacement between each sample update. Figure 41 shows the orientation of each delta angle output, which defines the direction of rotation that produces a positive response in each of the angular displacement (delta angle) measurements.

The delta angle outputs represent an integration of the gyroscope measurements and use the following formula for all three axes (x-axis displayed):

$$\Delta\theta_{x,nD} = \frac{1}{2f_s} \times \sum_{d=0}^{D-1} (\omega_{x,nD+d} + \omega_{x,nD+d-1})$$

where:

- $\Delta\theta_x$ is the delta angle measurement for the x-axis
- D is the decimation rate = DEC_RATE + 1 (see Table 150).
- f_s is the sample rate.
- d is the incremental variable in the summation formula.
- ω_x is the x-axis rate of rotation (gyroscope).
- n is the sample time, prior to the decimation filter.

When using the internal sample clock, f_s is equal to 4250 SPS. When using the external clock option, f_s is equal to the frequency of the external clock. The range in the delta angle registers accommodates the maximum rate of rotation (100°/sec), the nominal sample rate (4250 SPS), and an update rate of 1 Hz (DEC_RATE = 0x1099; divide by 4249 plus 1, see Table 150), all at the same time. When using an external clock that is higher than 4250 SPS, reduce the DEC_RATE setting to avoid over-ranging the delta angle registers.

Each axis of the delta angle measurements has two output data registers. Figure 42 shows how these two registers combine to support a 32-bit, twos complement data format for the x-axis delta angle measurements. This format also applies to the y-axis and z-axis.

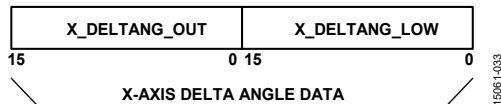

Figure 42. Delta Angle Output Data Structure

Delta Angle Measurement Range

Table 60 offers the measurement range and scale factor for each ADIS16497 model.

Table 60. Delta Angle Measurement Range and Scale Factor

Model	Measurement Range, $\pm\Delta\theta_{MAX}$
ADIS16497-1	$\pm 360^\circ$
ADIS16497-2	$\pm 720^\circ$
ADIS16497-3	$\pm 2160^\circ$

X-Axis Delta Angle (X_DELTANG_LOW, X_DELTANG_OUT)

The X_DELTANG_LOW (see Table 61 and Table 62) and X_DELTANG_OUT (see Table 63 and Table 64) registers contain the delta angle data for the x-axis.

Table 61. X_DELTANG_LOW Register Definitions

Page	Addresses	Default	Access	Flash Backup
0x00	0x40, 0x41	Not applicable	R	No

Table 62. X_DELTANG_LOW Bit Descriptions

Bits	Description
[15:0]	X-axis delta angle data; low word

Table 63. X_DELTANG_OUT Register Definitions

Page	Addresses	Default	Access	Flash Backup
0x00	0x42, 0x43	Not applicable	R	No

Table 64. X_DELTANG_OUT Bit Descriptions

Bits	Description
[15:0]	X-axis delta angle data; twos complement, $0^\circ = 0x0000$, 1 LSB = $\Delta\theta_{MAX}/2^{15}$ (see Table 60 for $\Delta\theta_{MAX}$)

Y-Axis Delta Angle (Y_DELTANG_LOW, Y_DELTANG_OUT)

The Y_DELTANG_LOW (see Table 65 and Table 66) and Y_DELTANG_OUT (see Table 67 and Table 68) registers contain the delta angle data for the y-axis.

Table 65. Y_DELTANG_LOW Register Definitions

Page	Addresses	Default	Access	Flash Backup
0x00	0x44, 0x45	Not applicable	R	No

Table 66. Y_DELTANG_LOW Bit Descriptions

Bits	Description
[15:0]	Y-axis delta angle data; low word

Table 67. Y_DELTANG_OUT Register Definitions

Page	Addresses	Default	Access	Flash Backup
0x00	0x46, 0x47	Not applicable	R	No

Table 68. Y_DELTANG_OUT Bit Descriptions

Bits	Description
[15:0]	Y-axis delta angle data; twos complement, 0° = 0x0000, 1 LSB = Δθ _{MAX} /2 ¹⁵ (see Table 60 for Δθ _{MAX})

Z-Axis Delta Angle (Z_DELTANG_LOW, Z_DELTANG_OUT)

The Z_DELTANG_LOW (see Table 69 and Table 70) and Z_DELTANG_OUT (see Table 71 and Table 72) registers contain the delta angle data for the z-axis.

Table 69. Z_DELTANG_LOW Register Definitions

Page	Addresses	Default	Access	Flash Backup
0x00	0x48, 0x49	Not applicable	R	No

Table 70. Z_DELTANG_LOW Bit Descriptions

Bits	Description
[15:0]	Z-axis delta angle data; low word

Table 71. Z_DELTANG_OUT Register Definitions

Page	Addresses	Default	Access	Flash Backup
0x00	0x4A, 0x4B	Not applicable	R	No

Table 72. Z_DELTANG_OUT Bit Descriptions

Bits	Description
[15:0]	Z-axis delta angle data; twos complement, 0° = 0x0000, 1 LSB = Δθ _{MAX} /2 ¹⁵ (see Table 60 for Δθ _{MAX})

Delta Angle Resolution

Table 73 and Table 74 show various numerical examples that demonstrate the format of the delta angle data in both 16-bit and 32-bit formats.

Table 73. 16-Bit Delta Angle Data Format Examples

Delta Angle (°)	Decimal	Hex	Binary
Δθ _{MAX} × (2 ¹⁵ - 1) / 2 ¹⁵	+32,767	0x7FFF	0111 1111 1110 1111
+Δθ _{MAX} / 2 ¹⁴	+2	0x0002	0000 0000 0000 0010
+Δθ _{MAX} / 2 ¹⁵	+1	0x0001	0000 0000 0000 0001
0	0	0x0000	0000 0000 0000 0000
-Δθ _{MAX} / 2 ¹⁵	-1	0xFFFF	1111 1111 1111 1111
-Δθ _{MAX} / 2 ¹⁴	-2	0xFFFFE	1111 1111 1111 1110
-Δθ _{MAX}	-32,768	0x8000	1000 0000 0000 0000

Table 74. 32-Bit Delta Angle Data Format Examples

Delta Angle (°)	Decimal	Hexadecimal
+Δθ _{MAX} × (2 ³¹ - 1) / 2 ³¹	+2,147,483,647	0x7FFFFFFF
+Δθ _{MAX} / 2 ³⁰	+2	0x00000002
+Δθ _{MAX} 2000 / 2 ³¹	+1	0x00000001
0	0	0x00000000
-Δθ _{MAX} / 2 ³¹	-1	0xFFFFFFFF
-Δθ _{MAX} / 2 ³⁰	-2	0xFFFFFFFFE
-Δθ _{MAX}	-2,147,483,648	0x80000000

DELTA VELOCITY

In addition to the linear acceleration measurements along each axis (x, y, and z), the ADIS16497 also provides delta velocity measurements that represent a computation of linear velocity change between each sample update. Figure 44 shows the orientation of each delta-velocity measurement, which defines the direction of linear velocity increase that produces a positive response in each of the delta velocity rate measurements.

The delta velocity outputs represent an integration of the acceleration measurements and use the following formula for all three axes (x-axis displayed):

$$\Delta V_{x,nD} = \frac{1}{2f_s} \times \sum_{d=0}^{D-1} (a_{x,nD+d} + a_{x,nD+d-1})$$

where:

ΔV_x is the delta velocity measurement for the x-axis.

D is the decimation rate = DEC_RATE + 1 (see Table 150).

f_s is the sample rate.

d is the incremental variable in the summation formula.

a_x is the x-axis rate of acceleration (accelerometer).

n is the sample time, prior to the decimation filter.

When using the internal sample clock, f_s is equal to 4250 SPS. When using the external clock option, f_s is equal to the frequency of the external clock. The range in the delta velocity registers accommodates the maximum linear acceleration (8 g), the nominal sample rate (4250 SPS), and an update rate of 1 Hz (DEC_RATE = 0x1099; divide by 4249 plus 1, see Table 150), all at the same time. When using an external clock that is higher than 4250 SPS, reduce the DEC_RATE setting to avoid overranging the delta velocity registers.

Each axis of the delta velocity measurements has two output data registers. Figure 43 shows how these two registers combine to support 32-bit, twos complement data format for the delta velocity measurements along the x-axis. This format also applies to the y-axis and z-axis.

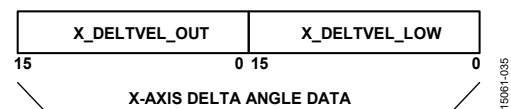

Figure 43. Delta Angle Output Data Structure

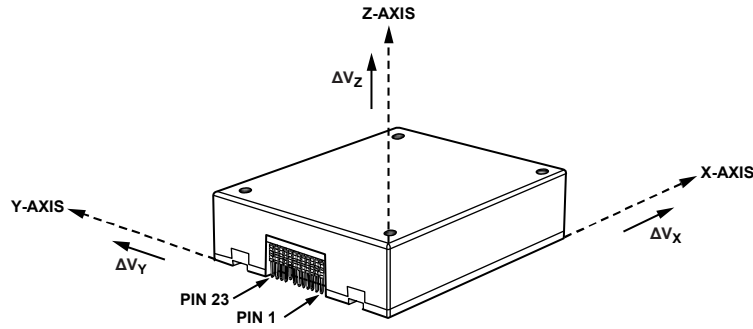

Figure 44. Delta Velocity Axis and Polarity Assignments

X-Axis Delta Velocity (X_DELTVEL_LOW, X_DELTVEL_OUT)

The X_DELTVEL_LOW (see Table 75 and Table 76) and X_DELTVEL_OUT (see Table 77 and Table 78) registers contain the delta velocity data for the x-axis.

Table 75. X_DELTVEL_LOW Register Definitions

Page	Addresses	Default	Access	Flash Backup
0x00	0x4C, 0x4D	Not applicable	R	No

Table 76. X_DELTVEL_LOW Bit Descriptions

Bits	Description
[15:0]	X-axis delta angle data; low word

Table 77. X_DELTVEL_OUT Register Definitions

Page	Addresses	Default	Access	Flash Backup
0x00	0x4E, 0x4F	Not applicable	R	No

Table 78. X_DELTVEL_OUT Bit Descriptions

Bits	Description
[15:0]	X-axis delta velocity data; high word; twos complement, ± 400 m/sec range, 0 m/sec = 0x0000; 1 LSB = $400 \text{ m/sec} \div 2^{15} = \sim 12.208 \text{ mm/sec}$

Y-Axis Delta Velocity (Y_DELTVEL_LOW, Y_DELTVEL_OUT)

The Y_DELTVEL_LOW (see Table 79 and Table 80) and Y_DELTVEL_OUT (see Table 81 and Table 82) registers contain the delta velocity data for the y-axis.

Table 79. Y_DELTVEL_LOW Register Definitions

Page	Addresses	Default	Access	Flash Backup
0x00	0x50, 0x51	Not applicable	R	No

Table 80. Y_DELTVEL_LOW Bit Descriptions

Bits	Description
[15:0]	Y-axis delta angle data; low word

Table 81. Y_DELTVEL_OUT Register Definitions

Page	Addresses	Default	Access	Flash Backup
0x00	0x52, 0x53	Not applicable	R	No

Table 82. Y_DELTVEL_OUT Bit Descriptions

Bits	Description
[15:0]	Y-axis delta velocity data; high word; twos complement, ± 400 m/sec range, 0 m/sec = 0x0000; 1 LSB = $400 \text{ m/sec} \div 2^{15} = \sim 12.208 \text{ mm/sec}$

Z-Axis Delta Velocity (Z_DELTVEL_LOW, Z_DELTVEL_OUT)

The Z_DELTVEL_LOW (see Table 83 and Table 84) and Z_DELTVEL_OUT (see Table 85 and Table 86) registers contain the delta velocity data for the z-axis.

Table 83. Z_DELTVEL_LOW Register Definitions

Page	Addresses	Default	Access	Flash Backup
0x00	0x54, 0x55	Not applicable	R	No

Table 84. Z_DELTVEL_LOW Bit Descriptions

Bits	Description
[15:0]	Z-axis delta angle data; low word

Table 85. Z_DELTVEL_OUT Register Definitions

Page	Addresses	Default	Access	Flash Backup
0x00	0x56, 0x57	Not applicable	R	No

Table 86. Z_DELTVEL_OUT Bit Descriptions

Bits	Description
[15:0]	Z-axis delta velocity data; high word; twos complement, ± 400 m/sec range, 0 m/sec = 0x0000; 1 LSB = $400 \text{ m/sec} \div 2^{15} = \sim 12.208 \text{ mm/sec}$

Delta Velocity Resolution

Table 87 and Table 88 show various numerical examples that demonstrate the format of the delta angle data in both 16-bit and 32-bit formats.

Table 87. 16-Bit Delta Velocity Data Format Examples

Velocity (m/sec)	Decimal	Hex	Binary
$+400 \times (2^{15} - 1)/2^{15}$	+32,767	0x7FFF	0111 1111 1110 1111
$+400/2^{14}$	+2	0x0002	0000 0000 0000 0010
$+400/2^{15}$	+1	0x0001	0000 0000 0000 0001
0	0	0x0000	0000 0000 0000 0000
$-400/2^{15}$	-1	0xFFFF	1111 1111 1111 1111
$-400/2^{14}$	-2	0xFFFFE	1111 1111 1111 1110
-400	-32,768	0x8000	1000 0000 0000 0000

Table 88. 32-Bit Delta Angle Data Format Examples

Velocity (m/sec)	Decimal	Hex
$+400 \times (2^{31} - 1)/2^{31}$	+2,147,483,647	0x7FFFFFFF
$+400/2^{30}$	+2	0x00000002
$+400/2^{31}$	+1	0x00000001
0	0	0x00000000
$-400/2^{31}$	-1	0xFFFFFFFF
$-400/2^{30}$	-2	0xFFFFFFFFE
-400	-2,147,483,648	0x80000000

Burst Read Command, BURST_CMD

Reading the BURST_CMD register (see Table 89 and Table 90) starts the BRF. See Table 10, Table 11, Figure 5, and Figure 6 for more information on the BRF function.

Table 89. BURST_CMD Register Definitions

Page	Addresses	Default	Access	Flash Backup
0x00	0x7C, 0x7D	Not Applicable	R	No

Table 90. BURST_CMD Bit Descriptions

Bits	Description
[15:0]	Burst read command register

Product Identification, PROD_ID

The PROD_ID register (see Table 91 and Table 92) contains the numerical portion of the device number (16,497). See Figure 34 for an example of how to use a looping read of this register to validate the integrity of the communication.

Table 91. PROD_ID Register Definitions

Page	Addresses	Default	Access	Flash Backup
0x00	0x7E, 0x7F	0x4071	R	Yes

Table 92. PROD_ID Bit Descriptions

Bits	Description
[15:0]	Product identification = 0x4071

USER BIAS/SCALE ADJUSTMENT

The signal chain of each inertial sensor (accelerometers, gyroscopes) includes application of unique correction formulas that come from extensive characterization of bias, sensitivity, alignment, and response to linear acceleration (gyroscopes) over a temperature range of -40°C to $+85^{\circ}\text{C}$ for the ADIS16497. These correction formulas are not accessible, but the user does have the opportunity to adjust the bias and the scale factor, for each sensor individually, through user accessible registers. These correction factors follow immediately after the factory derived correction formulas in the signal chain, which processes at a rate of 4250 Hz when using the internal sample clock (see f_{SM} in Figure 22 and Figure 23).

Gyroscope Scale Adjustment, X_GYRO_SCALE

The X_GYRO_SCALE register (see Table 93 and Table 94) provides the user with the opportunity to adjust the scale factor for the x-axis gyroscopes. See Figure 45 for an illustration of how this scale factor influences the x-axis gyroscope data.

Table 93. X_GYRO_SCALE Register Definitions

Page	Addresses	Default	Access	Flash Backup
0x02	0x04, 0x05	0x0000	R/W	Yes

Table 94. X_GYRO_SCALE Bit Descriptions

Bits	Description
[15:0]	X-axis gyroscope scale correction; twos complement, 0x0000 = unity gain, 1 LSB = $1 \div 2^{15} = \sim 0.003052\%$

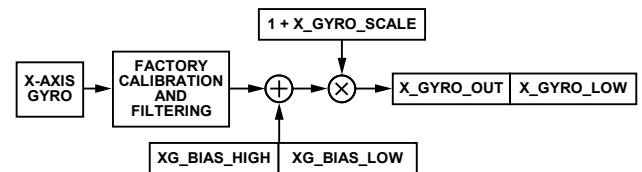

Figure 45. User Bias/Scale Adjustment Registers in Gyroscope Signal Path

Gyroscope Scale Adjustment, Y_GYRO_SCALE

The Y_GYRO_SCALE register (see Table 95 and Table 96) allows the user to adjust the scale factor for the y-axis gyroscopes. This register influences the y-axis gyroscope measurements in the same manner that X_GYRO_SCALE influences the x-axis gyroscope measurements (see Figure 45).

Table 95. Y_GYRO_SCALE Register Definitions

Page	Addresses	Default	Access	Flash Backup
0x02	0x06, 0x07	0x0000	R/W	Yes

Table 96. Y_GYRO_SCALE Bit Descriptions

Bits	Description
[15:0]	Y-axis gyroscope scale correction; twos complement, 0x0000 = unity gain, 1 LSB = $1 \div 2^{15} = \sim 0.003052\%$

Gyroscope Scale Adjustment, Z_GYRO_SCALE

The Z_GYRO_SCALE register (see Table 97 and Table 98) allows the user to adjust the scale factor for the z-axis gyroscopes. This register influences the z-axis gyroscope measurements in the same manner that X_GYRO_SCALE influences the x-axis gyroscope measurements (see Figure 45).

Table 97. Z_GYRO_SCALE Register Definitions

Page	Addresses	Default	Access	Flash Backup
0x02	0x08, 0x09	0x0000	R/W	Yes

Table 98. Z_GYRO_SCALE Bit Descriptions

Bits	Description
[15:0]	Z-axis gyroscope scale correction; twos complement, 0x0000 = unity gain, 1 LSB = $1 \div 2^{15} = \sim 0.003052\%$

Accelerometer Scale Adjustment, X_ACCL_SCALE

The X_ACCL_SCALE register (see Table 99 and Table 100) allows the user to adjust the scale factor for the x-axis accelerometers. See Figure 46 for an illustration of how this scale factor influences the x-axis accelerometer data.

Table 99. X_ACCL_SCALE Register Definitions

Page	Addresses	Default	Access	Flash Backup
0x02	0x0A, 0x0B	0x0000	R/W	Yes

Table 100. X_ACCL_SCALE Bit Descriptions

Bits	Description
[15:0]	X-axis accelerometer scale correction; twos complement, 0x0000 = unity gain, 1 LSB = $1 \div 2^{15} = \sim 0.003052\%$

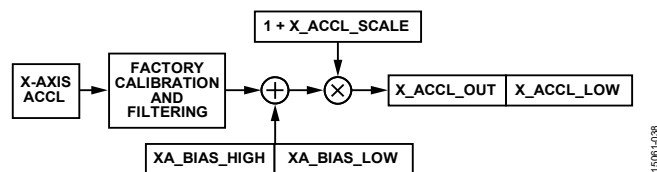

Figure 46. User Bias/Scale Adjustment Registers in Accelerometer Signal Path

Accelerometer Scale Adjustment, Y_ACCL_SCALE

The Y_ACCL_SCALE register (see Table 101 and Table 102) allows the user to adjust the scale factor for the y-axis accelerometers. This register influences the y-axis accelerometer measurements in the same manner that X_ACCL_SCALE influences the x-axis accelerometer measurements (see Figure 46).

Table 101. Y_ACCL_SCALE Register Definitions

Page	Addresses	Default	Access	Flash Backup
0x02	0x0C, 0x0D	0x0000	R/W	Yes

Table 102. Y_ACCL_SCALE Bit Descriptions

Bits	Description
[15:0]	Y-axis accelerometer scale correction; twos complement, 0x0000 = unity gain, 1 LSB = $1 \div 2^{15} = \sim 0.003052\%$

Accelerometer Scale Adjustment, Z_ACCL_SCALE

The Z_ACCL_SCALE register (see Table 103 and Table 104) allows the user to adjust the scale factor for the z-axis accelerometers. This register influences the z-axis accelerometer measurements in the same manner that X_ACCL_SCALE influences the x-axis accelerometer measurements (see Figure 46).

Table 103. Z_ACCL_SCALE Register Definitions

Page	Addresses	Default	Access	Flash Backup
0x02	0x0E, 0x0F	0x0000	R/W	Yes

Table 104. Z_ACCL_SCALE Bit Descriptions

Bits	Description
[15:0]	Z-axis accelerometer scale correction; twos complement, 0x0000 = unity gain, 1 LSB = $1 \div 2^{15} = \sim 0.003052\%$

Gyroscope Bias Adjustment, XG_BIAS_LOW, XG_BIAS_HIGH

The XG_BIAS_LOW (see Table 105 and Table 106) and XG_BIAS_HIGH (see Table 107 and Table 108) registers combine to allow the user to adjust the bias of the x-axis gyroscopes. The digital format examples in Table 25 also apply to the XG_BIAS_HIGH register, and the digital format examples in Table 26 apply to the number that comes from combining the XG_BIAS_LOW and XG_BIAS_HIGH registers. See Figure 45 for an illustration of how these two registers combine and influence the x-axis gyroscope measurements.

Table 105. XG_BIAS_LOW Register Definitions

Page	Addresses	Default	Access	Flash Backup
0x02	0x10, 0x11	0x0000	R/W	Yes

Table 106. XG_BIAS_LOW Bit Descriptions

Bits	Description
[15:0]	X-axis gyroscope offset correction, low word; twos complement, 0°/sec = 0x0000, 1 LSB = $K_G \div 2^{16}$ (see Table 24)

Table 107. XG_BIAS_HIGH Register Definitions

Page	Addresses	Default	Access	Flash Backup
0x02	0x12, 0x13	0x0000	R/W	Yes

Table 108. XG_BIAS_HIGH Bit Descriptions

Bits	Description
[15:0]	X-axis gyroscope offset correction, high word twos complement, 0°/sec = 0x0000, 1 LSB = K_G (see Table 24)

Gyroscope Bias Adjustment, YG_BIAS_LOW, YG_BIAS_HIGH

The YG_BIAS_LOW (see Table 109 and Table 110) and YG_BIAS_HIGH (see Table 111 and Table 112) registers combine to allow the user to adjust the bias of the y-axis gyroscopes. The digital format examples in Table 25 also apply to the YG_BIAS_HIGH register, and the digital format examples in Table 26 apply to the number that comes from combining the YG_BIAS_LOW and YG_BIAS_HIGH registers. These registers influence the y-axis gyroscope measurements in the same manner that the XG_BIAS_LOW and XG_BIAS_HIGH registers influence the x-axis gyroscope measurements (see Figure 45).

Table 109. YG_BIAS_LOW Register Definitions

Page	Addresses	Default	Access	Flash Backup
0x02	0x14, 0x15	0x0000	R/W	Yes

Table 110. YG_BIAS_LOW Bit Descriptions

Bits	Description
[15:0]	Y-axis gyroscope offset correction, low word; twos complement, $0^\circ/\text{sec} = 0x0000$, 1 LSB = $0.005^\circ/\text{sec} \div 2^{16}$

Table 111. YG_BIAS_HIGH Register Definitions

Page	Addresses	Default	Access	Flash Backup
0x02	0x16, 0x17	0x0000	R/W	Yes

Table 112. YG_BIAS_HIGH Bit Descriptions

Bits	Description
[15:0]	Y-axis gyroscope offset correction, high word; twos complement, $0^\circ/\text{sec} = 0x0000$, 1 LSB = $0.005^\circ/\text{sec}$

Gyroscope Bias Adjustment, ZG_BIAS_LOW, ZG_BIAS_HIGH

The ZG_BIAS_LOW (see Table 113 and Table 114) and ZG_BIAS_HIGH (see Table 115 and Table 116) registers combine to allow the user to adjust the bias of the z-axis gyroscopes. The digital format examples in Table 25 also apply to the ZG_BIAS_HIGH register, and the digital format examples in Table 26 apply to the number that comes from combining the ZG_BIAS_LOW and ZG_BIAS_HIGH registers. These registers influence the z-axis gyroscope measurements in the same manner that the XG_BIAS_LOW and XG_BIAS_HIGH registers influence the x-axis gyroscope measurements (see Figure 45).

Table 113. ZG_BIAS_LOW Register Definitions

Page	Addresses	Default	Access	Flash Backup
0x02	0x18, 0x19	0x0000	R/W	Yes

Table 114. ZG_BIAS_LOW Bit Descriptions

Bits	Description
[15:0]	Z-axis gyroscope offset correction, low word; twos complement, $0^\circ/\text{sec} = 0x0000$, 1 LSB = $0.005^\circ/\text{sec} \div 2^{16}$

Table 115. ZG_BIAS_HIGH Register Definitions

Page	Addresses	Default	Access	Flash Backup
0x02	0x1A, 0x1B	0x0000	R/W	Yes

Table 116. ZG_BIAS_HIGH Bit Definitions

Bits	Description
[15:0]	Z-axis gyroscope offset correction, high word twos complement, $0^\circ/\text{sec} = 0x0000$, 1 LSB = $0.005^\circ/\text{sec}$

Accelerometer Bias Adjustment, XA_BIAS_LOW, XA_BIAS_HIGH

The XA_BIAS_LOW (see Table 117 and Table 118) and XA_BIAS_HIGH (see Table 119 and Table 120) registers combine to allow the user to adjust the bias of the x-axis accelerometers. The digital format examples in Table 51 also apply to the XA_BIAS_HIGH register and the digital format examples in Table 52 apply to the number that comes from combining the XA_BIAS_LOW and XA_BIAS_HIGH registers. See Figure 46 for an illustration of how these two registers combine and influence the x-axis accelerometer measurements.

Table 117. XA_BIAS_LOW Register Definitions

Page	Addresses	Default	Access	Flash Backup
0x02	0x1C, 0x1D	0x0000	R/W	Yes

Table 118. XA_BIAS_LOW Bit Descriptions

Bits	Description
[15:0]	X-axis accelerometer offset correction, low word, twos complement, $0 g = 0x0000$, 1 LSB = $1.25 mg \div 2^{16}$

Table 119. XA_BIAS_HIGH Register Definitions

Page	Addresses	Default	Access	Flash Backup
0x02	0x1E, 0x1F	0x0000	R/W	Yes

Table 120. XA_BIAS_HIGH Bit Descriptions

Bits	Description
[15:0]	X-axis accelerometer offset correction, high word, twos complement, $0 g = 0x0000$, 1 LSB = $1.25 mg$

Accelerometer Bias Adjustment, YA_BIAS_LOW, YA_BIAS_HIGH

The YA_BIAS_LOW (see Table 121 and Table 122) and YA_BIAS_HIGH (see Table 123 and Table 124) registers combine to allow the user to adjust the bias of the y-axis accelerometers. The digital format examples in Table 51 also apply to the YA_BIAS_HIGH register, and the digital format examples in Table 52 apply to the number that comes from combining the YA_BIAS_LOW and YA_BIAS_HIGH registers. These registers influence the y-axis accelerometer measurements in the same manner that the XA_BIAS_LOW and XA_BIAS_HIGH registers influence the x-axis accelerometer measurements (see Figure 46).

Table 121. YA_BIAS_LOW Register Definitions

Page	Addresses	Default	Access	Flash Backup
0x02	0x20, 0x21	0x0000	R/W	Yes

Table 122. YA_BIAS_LOW Bit Descriptions

Bits	Description
[15:0]	Y-axis accelerometer offset correction, low word, twos complement, $0 g = 0x0000$, $1 \text{ LSB} = 1.25 \text{ mg} \div 2^{16}$

Table 123. YA_BIAS_HIGH Register Definitions

Page	Addresses	Default	Access	Flash Backup
0x02	0x22, 0x23	0x0000	R/W	Yes

Table 124. YA_BIAS_HIGH Bit Descriptions

Bits	Description
[15:0]	Y-axis accelerometer offset correction, high word, twos complement, $0 g = 0x0000$, $1 \text{ LSB} = 1.25 \text{ mg}$

Accelerometer Bias Adjustment, ZA_BIAS_LOW, ZA_BIAS_HIGH

The ZA_BIAS_LOW (see Table 125 and Table 126) and ZA_BIAS_HIGH (see Table 127 and Table 128) registers combine to allow the user to adjust the bias of the z-axis accelerometers. The digital format examples in Table 51 also apply to the ZA_BIAS_HIGH register and the digital format examples in Table 52 apply to the number that comes from combining the ZA_BIAS_LOW and ZA_BIAS_HIGH registers. These registers influence the z-axis accelerometer measurements in the same manner that the XA_BIAS_LOW and XA_BIAS_HIGH registers influence the x-axis accelerometer measurements (see Figure 46).

Table 125. ZA_BIAS_LOW Register Definitions

Page	Addresses	Default	Access	Flash Backup
0x02	0x24, 0x25	0x0000	R/W	Yes

Table 126. ZA_BIAS_LOW Bit Descriptions

Bits	Description
[15:0]	Z-axis accelerometer offset correction, low word, twos complement, $0 g = 0x0000$, $1 \text{ LSB} = 1.25 \text{ mg} \div 2^{16}$

Table 127. ZA_BIAS_HIGH Register Definitions

Page	Addresses	Default	Access	Flash Backup
0x02	0x26, 0x27	0x0000	R/W	Yes

Table 128. ZA_BIAS_HIGH Bit Descriptions

Bits	Description
[15:0]	Z-axis accelerometer offset correction, high word, twos complement, $0 g = 0x0000$, $1 \text{ LSB} = 1.25 \text{ mg}$

SCRATCH REGISTERS, USER_SCR_X

The USER_SCR_1 (see Table 129 and Table 130), USER_SCR_2 (see Table 131 and Table 132), USER_SCR_3 (see Table 133 and Table 134), and the USER_SCR_4 (see Table 135 and Table 136) registers provide four locations for the user to store information.

Table 129. USER_SCR_1 Register Definitions

Page	Addresses	Default	Access	Flash Backup
0x02	0x74, 0x75	0x0000	R/W	Yes

Table 130. USER_SCR_1 Bit Descriptions

Bits	Description
[15:0]	User defined

Table 131. USER_SCR_2 Register Definitions

Page	Addresses	Default	Access	Flash Backup
0x02	0x76, 0x77	0x0000	R/W	Yes

Table 132. USER_SCR_2 Bit Descriptions

Bits	Description
[15:0]	User defined

Table 133. USER_SCR_3 Register Definitions

Page	Addresses	Default	Access	Flash Backup
0x02	0x78, 0x79	0x0000	R/W	Yes

Table 134. USER_SCR_3 Bit Descriptions

Bits	Description
[15:0]	User defined

Table 135. USER_SCR_4 Register Definitions

Page	Addresses	Default	Access	Flash Backup
0x02	0x7A, 0x7B	0x0000	R/W	Yes

Table 136. USER_SCR_4 Bit Descriptions

Bits	Description
[15:0]	User defined

FLASH MEMORY ENDURANCE COUNTER, FLSHCNT_LOW, FLSHCNT_HIGH

The FLSHCNT_LOW (see Table 137 and Table 138) and FLSHCNT_HIGH (see Table 139 and Table 140) registers combine to provide a 32-bit, binary counter that tracks the number of flash memory write cycles. In addition to the number of write cycles, the flash memory has a finite service lifetime, which depends on the junction temperature. Figure 47 provides guidance for estimating the retention life for the flash memory at specific junction temperatures. The junction temperature is approximately 7°C above the case temperature.

Table 137. FLSCNT_LOW Register Definitions

Page	Addresses	Default	Access	Flash Backup
0x02	0x7C, 0x7D	Not applicable	R	Yes

Table 138. FLSCNT_LOW Bit Descriptions

Bits	Description
[15:0]	Flash memory write counter, low word

Table 139. FLSCNT_HIGH Register Definitions

Page	Addresses	Default	Access	Flash Backup
0x02	0x7E, 0x7F	Not applicable	R	Yes

Table 140. FLSCNT_HIGH Bit Descriptions

Bits	Description
[15:0]	Flash memory write counter, high word

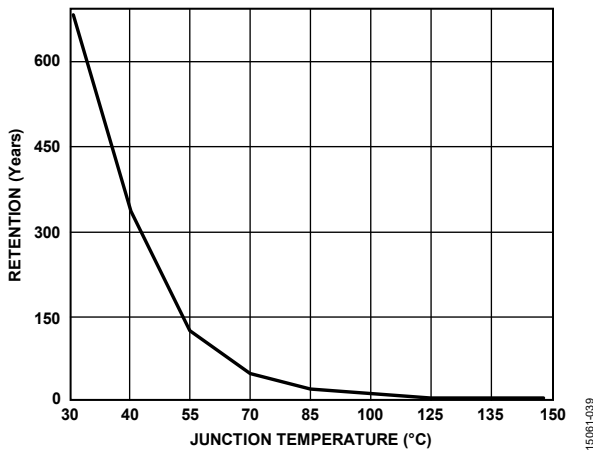

Figure 47. Flash Memory Retention

GLOBAL COMMANDS, GLOB_CMD

The GLOB_CMD register (see Table 141 and Table 142) provides trigger bits for several operations. Write a 1 to the appropriate bit in GLOB_CMD to start a particular function.

Table 141. GLOB_CMD Register Definitions

Page	Addresses	Default	Access	Flash Backup
0x03	0x02, 0x03	Not applicable	W	No

Table 142. GLOB_CMD Bit Descriptions

Bits	Description
[15:8]	Not used
7	Software reset
6	Clear user calibration
[5:4]	Not used
3	Flash memory update
2	Not used
1	Self test
0	Bias correction update

Software Reset

Select Page 3 (DIN = 0x8003) and then set GLOB_CMD, Bit 7 = 1 (DIN = 0x8280, then DIN = 0x8300) to initiate a reset in the operation of the ADIS16497. This reset removes all data, initializes all registers from their flash settings, and restarts data sampling and processing. This function provides a firmware alternative to providing a low pulse on the RST pin (see Table 6, Pin 8).

Clear User Calibration

Select Page 3 (DIN = 0x8003) and then set GLOB_CMD, Bit 6 = 1 (DIN = 0x8240, then DIN = 0x8300) to clear all user bias/scale adjustments for each accelerometer and gyroscope. This command writes 0x0000 to the following registers: X_GYRO_SCALE, Y_GYRO_SCALE, Z_GYRO_SCALE, X_ACCL_SCALE, Y_ACCL_SCALE, Z_ACCL_SCALE, XG_BIAS_LOW, XG_BIAS_HIGH, YG_BIAS_LOW, YG_BIAS_HIGH, ZG_BIAS_LOW, ZG_BIAS_HIGH, XA_BIAS_LOW, XA_BIAS_HIGH, YA_BIAS_LOW, YA_BIAS_HIGH, ZA_BIAS_LOW, and ZA_BIAS_HIGH.

Flash Memory Update

Select Page 3 (DIN = 0x8003) and then set GLOB_CMD, Bit 3 = 1 (DIN = 0x8208, DIN = 0x8300) to initiate a manual flash update. SYS_E_FLAG, Bit 6 (see Table 18) identifies success (0) or failure (1) in completing this process.

Note that the user must not poll the status registers while waiting for the update to complete because the serial port is disabled during the update. Rather, the user must either wait the prescribed amount of time found in Table 3 or wait for the data ready indicator pin to begin toggling.

On Demand Self Test (ODST)

Select Page 3 (DIN = 0x8003) and then set GLOB_CMD, Bit 1 = 1 (DIN = 0x8202, then DIN = 0x8300) to run the ODST routine, which executes the following steps:

1. Measure the output on each sensor.
2. Activate an internal force on the mechanical elements of each sensor, which simulates the force associated with actual inertial motion.
3. Measure the output response on each sensor.
4. Deactivate the internal force on each sensor.
5. Calculate the difference between the force on and normal operating conditions (force off).
6. Compare the difference with internal pass/fail criteria.
7. Report the pass/fail results for each sensor in DIAG_STS (see Table 20) and the overall pass/fail flag in SYS_E_FLAG, Bit 5 (see Table 18).

False positive results are possible when the executing the ODST while the device is in motion. Note that the user must not poll the status registers while waiting for the test to complete. Rather, the user must either wait the prescribed amount of time found in Table 3 or wait for the data ready indicator pin to begin toggling.

Bias Correction Update

Select Page 3 (DIN = 0x8003) and set GLOB_CMD, Bit 0 = 1 (DIN = 0x8201, then DIN = 0x8300) to update the user offset registers with the correction factors of the continuous bias estimation (CBE) (see Table 152). Ensure that the inertial platform is stable during the entire average time for optimal bias estimates.

AUXILIARY I/O LINE CONFIGURATION, FNCTIO_CTRL

The FNCTIO_CTRL register (see Table 143 and Table 144) provides configuration control for each I/O pin (DIO1, DIO2, DIO3, and DIO4). Each DIOx pin supports only one function at a time. When a single pin has two assignments, the enable bit for the lower priority function automatically resets to zero (disabling the lower priority function). The order of priority is as follows, from highest priority to lowest priority: data ready, sync clock input, and general-purpose. The ADIS16497 can take up to 20 ms to execute a write command to the FNCTIO_CTRL register. During this time, the operational state and the contents of the register remain unchanged, but the SPI interface supports normal communication (for accessing other registers).

Table 143. FNCTIO_CTRL Register Definitions

Page	Addresses	Default	Access	Flash Backup
0x03	0x06, 0x07	0x000D	R/W	Yes

Table 144. FNCTIO_CTRL Bit Descriptions

Bits	Description
[15:9]	Not used
8	Sync clock mode 1 = PPS 0 = sync
7	Sync clock input enable 1 = enabled 0 = disabled
6	Sync clock input polarity 1 = rising edge 0 = falling edge
[5:4]	Sync clock input line selection 00 = DIO1 01 = DIO2 10 = DIO3 11 = DIO4
3	Data ready enable: 1 = enabled 0 = disabled
2	Data ready polarity: 1 = positive 0 = negative
[1:0]	Data ready line selection 00 = DIO1 01 = DIO2 10 = DIO3 11 = DIO4

Data Ready Indicator

The FNCTIO_CTRL, Bits[3:0] provide three configuration options for the data ready function: on/off, polarity, and DIOx line. The primary purpose this signal is to drive the interrupt control line of an embedded processor, which can synchronize data collection and minimize latency. The data ready indicator is useful to determine if the controller inside the ADIS16497 is busy with a task (for example, a flash memory update) because data ready stops toggling while these tasks are performed and resumes on completion. The factory default assigns DIO2 as a positive polarity, data ready signal, which means the data in the output registers is valid when the DIO2 line is high (see Figure 29). This configuration works well when DIO2 drives an interrupt service pin that activates on a low to high pulse. Use the following sequence to change this assignment to DIO3 with negative polarity:

1. Select Page 3 (DIN = 0x8003).
2. Set FNCTIO_CTRL, Bits[3:0] = 1000 (DIN = 0x860A, then DIN = 0x8700).

The timing jitter on the data ready signal is typically within $\pm 1.4 \mu\text{s}$. When using DIO1 to support the data ready function, this signal can experience premature data ready pulses during the ADIS16497 start-up. However, these pulses do not indicate that data production has started. If it is necessary to use DIO1 for this function, use it in conjunction with a delay or other control mechanism to prevent premature data acquisition activity during the start-up process.

Input Sync/Clock Control

The FNCTIO_CTRL, Bits[8:4] provide several configuration options for using one of the DIOx lines as an external clock signal and for controlling inertial sensor data collection and processing. For example, use the following sequence to establish DIO4 as a positive polarity, input clock pin that operates in sync mode and preserves the factory default setting for the data ready function:

1. Select Page 3 (DIN = 0x8003).
2. Set FNCTIO_CTRL, Bits[7:0] = 0xFD (DIN = 0x86FD).
3. Set FNCTIO_CTRL, Bits[15:8] = 0x00 (DIN = 0x8700).

In sync mode, the ADIS16497 disables its internal sample clock, and the frequency of the external clock signal establishes the rate of data collection and processing (f_{SM} in Figure 22 and Figure 23). When using the PPS mode (FNCTIO_CTRL, Bit 8 = 1) the rate of data collection and production (f_{SM}) is equal to the product of the external clock frequency and scale factor (K_{ECSF}) in the SYNC_SCALE register (see Table 154).

GENERAL-PURPOSE I/O CONTROL, GPIO_CTRL

When FNCTIO_CTRL does not configure a DIOx pin, the GPIO_CTRL register (see Table 145 and Table 146) provides user controls for general-purpose use of the DIOx pins. GPIO_CTRL, Bits[3:0], provide I/O assignment controls for each line. When the DIOx lines are inputs, monitor their level by reading GPIO_CTRL, Bits[7:4]. When the DIOx lines are used as outputs, set their level by writing to GPIO_CTRL, Bits[7:4].

For example, use the following sequence to set DIO1 and DIO3 as high and low output lines, respectively, and set DIO2 and DIO4 as input lines. Select Page 3 (DIN = 0x8003) and set GPIO_CTRL, Bits[7:0] = 0x15 (DIN = 0x8815, then DIN = 0x8900).

Table 145. GPIO_CTRL Register Definitions¹

Page	Addresses	Default	Access	Flash Backup
0x03	0x08, 0x09	0x00X0	R/W	Yes

¹ The GPIO_CTRL, Bits[7:4] reflect the logic levels on the DIOx lines and do not have a default setting.

Table 146. GPIO_CTRL Bit Descriptions¹

Bits	Description
[15:8]	Don't care
7	General-Purpose I/O Line 4 (DIO4) data level
6	General-Purpose I/O Line 3 (DIO3) data level
5	General-Purpose I/O Line 2 (DIO2) data level
4	General-Purpose I/O Line 1 (DIO1) data level
3	General-Purpose I/O Line 4 (DIO4) direction control (1 = output, 0 = input)
2	General-Purpose I/O Line 3 (DIO3) direction control (1 = output, 0 = input)
1	General-Purpose I/O Line 2 (DIO2) direction control (1 = output, 0 = input)
0	General-Purpose I/O Line 1 (DIO1) direction control (1 = output, 0 = input)

¹ The GPIO_CTRL, Bits[7:4] reflect the logic levels on the DIOx lines and do not have a default setting.

MISCELLANEOUS CONFIGURATION, CONFIG

The CONFIG register (see Table 147 and Table 148) provides configuration options for the linear g compensation in the gyroscopes (on/off) and the point of percussion alignment for the accelerometers (on/off).

Table 147. CONFIG Register Definitions

Page	Addresses	Default	Access	Flash Backup
0x03	0x0A, 0x0B	0x00C0	R/W	Yes

Table 148. CONFIG Bit Descriptions

Bits	Description
[15:8]	Not used
7	Linear g compensation for gyroscopes (1 = enabled)
6	Point of percussion alignment (1 = enabled)
[5:0]	Not used

Point of Percussion

CONFIG, Bit 6 offers a point of percussion alignment function that maps the accelerometer sensors to the corner of the package identified in Figure 48. To activate this feature, select Page 3 (DIN = 0x8003), then set CONFIG, Bit 6 = 1 (DIN = 0x8A40, then DIN = 0x8B00).

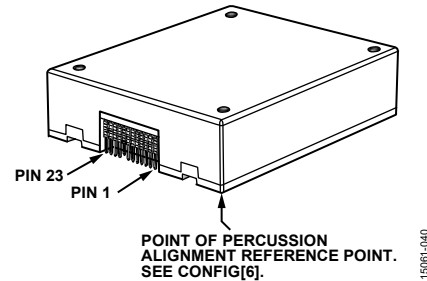

Figure 48. Point of Percussion Reference Point

LINEAR ACCELERATION ON EFFECT ON GYROSCOPE BIAS

The ADIS16497 includes first-order compensation for the linear g effect in the gyroscopes, which uses the following model:

$$\begin{bmatrix} \omega_{XC} \\ \omega_{YC} \\ \omega_{ZC} \end{bmatrix} = \begin{bmatrix} LG_{11} & LG_{12} & LG_{13} \\ LG_{21} & LG_{22} & LG_{23} \\ LG_{31} & LG_{32} & LG_{33} \end{bmatrix} \times \begin{bmatrix} A_X \\ A_Y \\ A_Z \end{bmatrix} + \begin{bmatrix} \omega_{XPC} \\ \omega_{YPC} \\ \omega_{ZPC} \end{bmatrix}$$

The linear g correction factors, LG_{XY}, apply correction for linear acceleration in all three directions to the data path of each gyroscope (ω_{XPC}, ω_{YPC}, and ω_{ZPC}) at the rate of the data samples (4250 SPS when using the internal clock). CONFIG, Bit 7, provides an on/off control for this compensation. The factory default value for this bit activates this compensation.

To turn it off, select Page 3 (DIN = 0x8003) and set CONFIG, Bit 7 = 0 (DIN = 0x8A40, then DIN = 0x8B00). This command sequence also preserves the default setting for the point of percussion alignment function (on).

DECIMATION FILTER, DEC_RATE

The DEC_RATE register (see Table 149 and Table 150) provides user control for the final filter stage (see Figure 25), which averages and decimates the accelerometers and gyroscopes data, and extends the time that the delta angle and delta velocity track between each update. The output sample rate is equal to 4250/(DEC_RATE + 1). For example, select Page 3 (DIN = 0x8003), and set DEC_RATE = 0x2A (DIN = 0x8C2A, then DIN = 0x8D00) to reduce the output sample rate to ~98.8 SPS (4250 ÷ 43).

Table 149. DEC_RATE Register Definitions

Page	Addresses	Default	Access	Flash Backup
0x03	0x0C, 0x0D	0x0000	R/W	Yes

Table 150. DEC_RATE Bit Descriptions

Bits	Description
[15:11]	Don't care
[10:0]	Decimation rate, binary format, maximum = 4249

CONTINUOUS BIAS ESTIMATION (CBE), NULL_CNFG

The NULL_CNFG register (see Table 151 and Table 152) provides the configuration controls for the CBE, which associates with the bias correction update command in GLOB_CMD, Bit 0 (see Table 142). NULL_CNFG, Bits[3:0], establishes the total average time (t_A) for the bias estimates and NULL_CNFG, Bits[13:8], provide on/off controls for each sensor. The factory default configuration for NULL_CNFG enables the bias null command for the gyroscopes, disables the bias null command for the accelerometers, and sets the average time to ~15.42 seconds.

- $t_B = 2^{TBC}/4250 = 2^{10}/4250 = \sim 0.241$ seconds
- $t_A = 64 \times t_B = 64 \times 0.241 = 15.42$ seconds

where:

t_B is the time base.

t_A is the averaging time.

When a sensor bit in NULL_CNFG is active (equal to 1), setting GLOB_CMD, Bit 0 = 1 (DIN sequence: 0x8003, 0x8201, 0x8300) causes its bias correction register to automatically update with a value that corrects for its present bias error (from the CBE). For example, setting NULL_CNFG, Bit 8 equal to 1 causes an update in the XG_BIAS_LOW (see Table 106) and XG_BIAS_HIGH (see Table 108) registers.

Table 151. NULL_CNFG Register Definitions

Page	Addresses	Default	Access	Flash Backup
0x03	0x0E, 0x0F	0x070A	R/W	Yes

Table 152. NULL_CNFG Bit Descriptions

Bits	Description
[15:14]	Not used
13	Z-axis acceleration bias correction enable (1 = enabled)
12	Y-axis acceleration bias correction enable (1 = enabled)
11	X-axis acceleration bias correction enable (1 = enabled)
10	Z-axis gyroscope bias correction enable (1 = enabled)
9	Y-axis gyroscope bias correction enable (1 = enabled)
8	X-axis gyroscope bias correction enable (1 = enabled)
[7:4]	Not used
[3:0]	Time base control (TBC), range: 0 to 13 (default = 10); $t_B = 2^{TBC}/4250$, time base; $t_A = 64 \times t_B$, average time

SCALING THE INPUT CLOCK (PPS MODE), SYNC_SCALE

The PPS mode (FNCTIO_CTRL, Bit 8 = 1, see Table 144) supports the use of an input sync frequency that is slower than the data sample rates of the inertial sensors. This mode supports a frequency range of 1 Hz to 128 Hz for the input sync mode. In this mode, the data sample rate is equal to the product of the value in the SYNC_SCALE register (see Table 153 and Table 154) and the input sync frequency. For example, the following command sequence sets the data collection and processing rate (f_{SM} in Figure 22 and Figure 23) to 4000 Hz (SYNC_SCALE = 0x0FA0) when using a 1 Hz signal on the DIO3 line as the external clock input, and preserves the factory default configuration for the data ready signal:

- Select Page 3 (DIN = 0x8003).
- Set SYNC_SCALE, Bits[7:0] = 0xA0 (DIN = 0x90A0).
- Set SYNC_SCALE, Bits[15:8] = 0x0F (DIN = 0x910F).
- Set FNCTIO_CTRL, Bits[7:0] = 0xFD (DIN = 0x86ED).
- Set FNCTIO_CTRL, Bits[15:8] = 0x00 (DIN = 0x8701).

Note that the data ready indicator pin does not begin to toggle until at least two external clock edges (with valid time period between them) are detected by the ADIS16497.

Table 153. SYNC_SCALE Register Definitions

Page	Addresses	Default	Access	Flash Backup
0x03	0x10, 0x11	0x109A	R/W	Yes

Table 154. SYNC_SCALE Bit Descriptions

Bits	Description
[15:0]	External clock scale factor (K_{ECFS}), binary format

Measurement Range Identifier, RANG_MDL

The RANG_MDL register (see Table 155 and Table 156) provides a convenient method for identifying the model (and gyroscope measurement range) of the ADIS16497.

Table 155. RANG_MDL Register Definitions¹

Page	Addresses	Default	Access	Flash Backup
0x03	0x12, 0x13	N/A	R	N/A

¹ N/A means not applicable.

Table 156. RANG_MDL Bit Descriptions

Bits	Description
[15:3]	Not used
[3:0]	0011 = ADIS16497-1 ($\pm 125^\circ/\text{sec}$) 0111 = ADIS16497-2 ($\pm 450^\circ/\text{sec}$) 1111 = ADIS16497-3 ($\pm 2000^\circ/\text{sec}$)

FIR FILTERS**FIR Filters Control, FILTR_BNK_0, FILTR_BNK_1**

The FILTR_BNK_0 (see Table 157 and Table 158) and FILTR_BNK_1 (see Table 159 and Table 160) registers provide the configuration controls for the FIR filter bank in the signal chain of each sensor (see Figure 25). These registers provide on/off control for the FIR bank for each inertial sensor, along with the FIR bank (A, B, C, or D) that each sensor uses.

Table 157. FILTR_BNK_0 Register Definitions

Page	Addresses	Default	Access	Flash Backup
0x03	0x16, 0x17	0x0000	R/W	Yes

Table 158. FILTR_BNK_0 Bit Descriptions

Bits	Description (Default = 0x0000)
15	Don't care
14	Y-axis accelerometer filter enable (1 = enabled)
[13:12]	Y-axis accelerometer filter bank selection 00 = Bank A 01 = Bank B 10 = Bank C 11 = Bank D
11	X-axis accelerometer filter enable (1 = enabled)
[10:9]	X-axis accelerometer filter bank selection 00 = Bank A 01 = Bank B 10 = Bank C 11 = Bank D
8	Z-axis gyroscope filter enable (1 = enabled)
[7:6]	Z-axis gyroscope filter bank selection 00 = Bank A 01 = Bank B 10 = Bank C 11 = Bank D
5	Y-axis gyroscope filter enable (1 = enabled)
[4:3]	Y-axis gyroscope filter bank selection 00 = Bank A 01 = Bank B 10 = Bank C 11 = Bank D
2	X-axis gyroscope filter enable (1 = enabled)
[1:0]	X-axis gyroscope filter bank selection 00 = Bank A 01 = Bank B 10 = Bank C 11 = Bank D

Table 159. FILTR_BNK_1 Register Definitions

Page	Addresses	Default	Access	Flash Backup
0x03	0x18, 0x19	0x0000	R/W	Yes

Table 160. FILTR_BNK_1 Bit Descriptions

Bits	Description
[15:3]	Don't care
2	Z-axis accelerometer filter enable (1 = enabled)
[1:0]	Z-axis accelerometer filter bank selection: 00 = Bank A 01 = Bank B 10 = Bank C 11 = Bank D

FIR Filter Bank Memory Maps

The ADIS16497 provides four FIR filter banks to configure and select for each individual inertial sensor using the FILTR_BNK_0 (see Table 158) and FILTR_BNK_1 (see Table 160) registers. Each FIR filter bank (A, B, C, and D) has 120 taps that consume two pages of memory. The coefficient associated with each tap, in each filter bank, has its own dedicated register that uses a 16-bit, twos complement format. The FIR filter has unity gain when the sum of all of the coefficients is equal to 32,768. For filter designs that require less than 120 taps, write 0x0000 to all unused registers to eliminate the latency associated with that particular tap.

FIR Filter Bank A, FIR_COEF_A000 to FIR_COEF_A119**Table 161. FIR Filter Bank A Memory Map**

Page	PAGE_ID	Addresses	Register
5	0x05	0x00, 0x01	PAGE_ID
5	0x05	0x02 to 0x07	Not used
5	0x05	0x08, 0x09	FIR_COEF_A000
5	0x05	0x0A, 0x0B	FIR_COEF_A001
5	0x05	0x0C to 0x7D	FIR_COEF_A002 to FIR_COEF_A058
5	0x05	0x7E, 0x7F	FIR_COEF_A059
6	0x06	0x00, 0x01	PAGE_ID
6	0x06	0x02 to 0x07	Not used
6	0x06	0x08, 0x09	FIR_COEF_A060
6	0x06	0x0A, 0x0B	FIR_COEF_A061
6	0x06	0x0C to 0x7D	FIR_COEF_A062 to FIR_COEF_A118
6	0x06	0x7E, 0x7F	FIR_COEF_A119

Table 162 and Table 163 provide detailed register and bit definitions for one of the FIR coefficient registers in Bank A, FIR_COEF_A071. Table 164 provides a configuration example, which sets this register to a decimal value of -169 (0xFF57).

Table 162. FIR_COEF_A071 Register Definitions

Page	Addresses	Default	Access	Flash Backup
0x06	0x1E, 0x1F	Not applicable	R/W	Yes

Table 163. FIR_COEF_A071 Bit Descriptions

Bits	Description
[15:0]	FIR Bank A, Coefficient 71, twos complement

Table 164. Configuration Example, FIR Coefficient

DIN Command	Description
0x8006	Select Page 6
0x9E57	FIR_COEF_A071, Bits[7:0] = 0x57
0x9FFF	FIR_COEF_A071, Bits[15:8] = 0xFF

FIR Filter Bank B, FIR_COEF_B000 to FIR_COEF_B119

Table 165. Filter Bank B Memory Map

Page	PAGE_ID	Addresses	Register
7	0x07	0x00, 0x01	PAGE_ID
7	0x07	0x02 to 0x07	Not used
7	0x07	0x08, 0x09	FIR_COEF_B000
7	0x07	0x0A, 0x0B	FIR_COEF_B001
7	0x07	0x0C to 0x7D	FIR_COEF_B002 to FIR_COEF_B058
7	0x07	0x7E, 0x07F	FIR_COEF_B059
8	0x08	0x00, 0x01	PAGE_ID
8	0x08	0x02 to 0x07	Not used
8	0x08	0x08, 0x09	FIR_COEF_B060
8	0x08	0x0A, 0x0B	FIR_COEF_B061
8	0x08	0x0C to 0x7D	FIR_COEF_B062 to FIR_COEF_B118
8	0x08	0x7E, 0x7F	FIR_COEF_B119

FIR Filter Bank C, FIR_COEF_C000 to FIR_COEF_C119

Table 166. Filter Bank C Memory Map

Page	PAGE_ID	Addresses	Register
9	0x09	0x00, 0x01	PAGE_ID
9	0x09	0x02 to 0x07	Not used
9	0x09	0x08, 0x09	FIR_COEF_C000
9	0x09	0x0A, 0x0B	FIR_COEF_C001
9	0x09	0x0C to 0x7D	FIR_COEF_C002 to FIR_COEF_C058
9	0x09	0x7E, 0x07F	FIR_COEF_C059
10	0x0A	0x00, 0x01	PAGE_ID
10	0x0A	0x02 to 0x07	Not used
10	0x0A	0x08, 0x09	FIR_COEF_C060
10	0x0A	0x0A, 0x0B	FIR_COEF_C061
10	0x0A	0x0C to 0x7D	FIR_COEF_C062 to FIR_COEF_C118
10	0x0A	0x7E, 0x7F	FIR_COEF_C119

FIR Filter Bank D, FIR_COEF_D000 to FIR_COEF_D119

Table 167. Filter Bank D Memory Map

Page	PAGE_ID	Addresses	Register
11	0x0B	0x00, 0x01	PAGE_ID
11	0x0B	0x02 to 0x07	Not used
11	0x0B	0x08, 0x09	FIR_COEF_D000
11	0x0B	0x0A, 0x0B	FIR_COEF_D001
11	0x0B	0x0C to 0x7D	FIR_COEF_D002 to FIR_COEF_D058
11	0x0B	0x7E, 0x07F	FIR_COEF_D059
12	0x0C	0x00, 0x01	PAGE_ID
12	0x0C	0x02 to 0x07	Not used
12	0x0C	0x08, 0x09	FIR_COEF_D060
12	0x0C	0x0A, 0x0B	FIR_COEF_D061
12	0x0C	0x0C to 0x7D	FIR_COEF_D062 to FIR_COEF_D118
12	0x0C	0x7E, 0x7F	FIR_COEF_D119

Default Filter Performance

The FIR filter banks have factory programmed filter designs that are all low-pass filters that have unity dc gain. Table 168 provides a summary of each filter design, and Figure 49 shows the frequency response characteristics. The phase delay is equal to ½ of the total number of taps.

Table 168. FIR Filter Descriptions, Default Configuration

FIR Filter Bank	Taps	-3 dB Frequency (Hz)
A	120	300
B	120	100
C	32	300
D	32	100

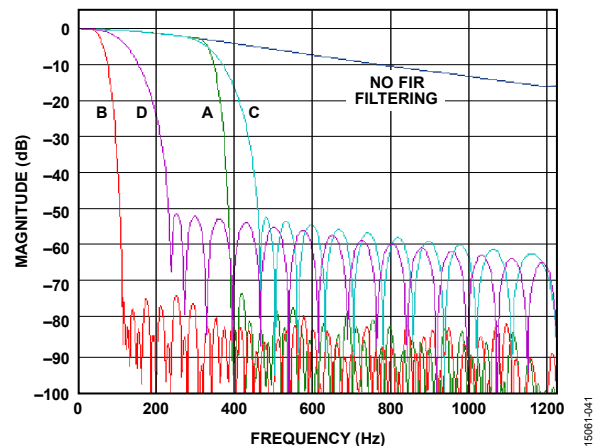

Figure 49. FIR Filter Frequency Response Curves

FIRMWARE REVISION, FIRM_REV

The FIRM_DM register (see Table 171 and Table 172) contains the month and day of the factory configuration date. Register FIRM_DM, Bits[15:12] and Register FIRM_DM, Bits[11:8] contain digits that represent the month of the factory configuration in a binary coded decimal (BCD) format. For example, November is the 11th month in a year and is represented by Register FIRM_DM, Bits[15:8] = 0x11. Register FIRM_DM, Bits[7:4] and Register FIRM_DM, Bits[3:0], contain digits that represent the day of factory configuration in a BCD format. For example, the 27th day of the month is represented by FIRM_DM, Bits[7:0] = 0x27.

Table 169. FIRM_REV Register Definitions

Page	Addresses	Default	Access	Flash Backup
0x03	0x78, 0x79	Not applicable	R	Yes

Table 170. FIRM_REV Bit Descriptions

Bits	Description
[15:12]	Firmware revision BCD code, tens digit, numerical format = 4-bit binary, range = 0 to 9
[11:8]	Firmware revision BCD code, ones digit, numerical format = 4-bit binary, range = 0 to 9
[7:4]	Firmware revision BCD code, tenths digit, numerical format = 4-bit binary, range = 0 to 9
[3:0]	Firmware revision BCD code, hundredths digit, numerical format = 4-bit binary, range = 0 to 9

Table 171. FIRM_DM Register Definitions

Page	Addresses	Default	Access	Flash Backup
0x03	0x7A, 0x7B	Not applicable	R	Yes

Table 172. FIRM_DM Bit Descriptions

Bits	Description
[15:12]	Factory configuration month BCD code, tens digit, numerical format = 4-bit binary, range = 0 to 2
[11:8]	Factory configuration month BCD code, ones digit, numerical format = 4-bit binary, range = 0 to 9
[7:4]	Factory configuration day BCD code, tens digit, numerical format = 4-bit binary, range = 0 to 3
[3:0]	Factory configuration day BCD code, ones digit, numerical format = 4-bit binary, range = 0 to 9

FIRMWARE REVISION YEAR, FIRM_Y

The FIRM_Y register (see Table 173 and Table 174) contains the year of the factory configuration date. For example, the year 2013 is represented by FIRM_Y = 0x2013.

Table 173. FIRM_Y Register Definitions

Page	Addresses	Default	Access	Flash Backup
0x03	0x7C, 0x7D	Not applicable	R	Yes

Table 174. FIRM_Y Bit Descriptions

Bits	Description
[15:12]	Factory configuration year BCD code, thousands digit, numerical format = 4-bit binary, range = 0 to 9
[11:8]	Factory configuration year BCD code, hundreds digit, numerical format = 4-bit binary, range = 0 to 9
[7:4]	Factory configuration year BCD code, tens digit, numerical format = 4-bit binary, range = 0 to 3
[3:0]	Factory configuration year BCD code, ones digit, numerical format = 4-bit binary, range = 0 to 9

BOOT REVISION NUMBER, BOOT_REV**Table 175. BOOT_REV Register Definitions**

Page	Addresses	Default	Access	Flash Backup
0x03	0x7E, 0x7F	Not applicable	R	Yes

Table 176. BOOT_REV Bit Definitions

Bits	Description
[15:8]	Binary, major revision number
[7:0]	Binary, minor revision number

CONTINUOUS SRAM TESTING

This device employs a CRC function on the SRAM memory blocks that contain the program code (CODE_SIGTR_XXX) and the calibration coefficients (CAL_DRVTN_XXX). This process operates in the background and generates real-time, 32-bit CRC values for the program code and calibration coefficients, respectively. At the conclusion of each cycle, the processor writes these calculated values in the CAL_DRVTN_XXX and CODE_DRVTN_XXX registers (see Table 183, Table 184, Table 190, and Table 192) and compares them with the signature values, which reflect the state of these memory locations at the time of factory configuration. When the calculation results do not match the signature values, Register SYS_E_FLAG, Bit 2 increases to a 1. The respective signature values are available for user access through the CAL_SIGTR_XXX and CODE_SIGTR_XXX registers (see Table 177, Table 178, Table 179, Table 180, Table 186, and Table 188). The following conditions must be met for Register SYS_E_FLAG, Bit 2 to remain at the zero level:

- CAL_SIGTR_LWR = CAL_DRVTN_LWR
- CAL_SIGTR_UPR = CAL_DRVTN_UPR
- CODE_SIGTR_LWR = CODE_DRVTN_LWR
- CODE_SIGTR_UPR = CODE_DRVTN_UPR

Signature CRC, Calibration Values, CAL_SIGTR_LWR

Table 177. CAL_SIGTR_LWR Register Definitions

Page	Addresses	Default	Access	Flash Backup
0x04	0x04, 0x05	Not applicable	R	Yes

Table 178. CAL_SIGTR_LWR Bit Descriptions

Bits	Description
[15:0]	Factory programmed CRC value for the program code, low word

Signature CRC, Calibration Values, CAL_SIGTR_UPR

Table 179. CAL_SIGTR_UPR Register Definitions

Page	Addresses	Default	Access	Flash Backup
0x04	0x06, 0x07	Not applicable	R	Yes

Table 180. CAL_SIGTR_UPR Bit Descriptions

Bits	Description
[15:0]	Factory programmed CRC value for the program code, high word

Derived CRC, Calibration Values, CAL_DRVTN_LWR

Table 181. CAL_DRVTN_LWR Register Definitions

Page	Addresses	Default	Access	Flash Backup
0x04	0x08, 0x09	Not applicable	R	No

Table 182. CAL_DRVTN_LWR Bit Descriptions

Bits	Description
[15:0]	Calculated CRC value for the program code, low word

Derived CRC, Calibration Values, CAL_DRVTN_UPR

Table 183. CAL_DRVTN_UPR Register Definitions

Page	Addresses	Default	Access	Flash Backup
0x04	0x0A, 0x0B	Not applicable	R	No

Table 184. CAL_DRVTN_UPR Bit Descriptions

Bits	Description
[15:0]	Calculated CRC value for the program code, high word

Signature CRC, Program Code, CODE_SIGTR_LWR

Table 185. CODE_SIGTR_LWR Register Definitions

Page	Addresses	Default	Access	Flash Backup
0x04	0x0C, 0x0D	Not applicable	R	Yes

Table 186. CODE_SIGTR_LWR Bit Descriptions

Bits	Description
[15:0]	Factory programmed CRC value for the calibration coefficients, low word

Signature CRC, Program Code, CODE_SIGTR_UPR

Table 187. CODE_SIGTR_UPR Register Definitions

Page	Addresses	Default	Access	Flash Backup
0x04	0x0E, 0x0F	Not applicable	R	Yes

Table 188. CODE_SIGTR_UPR Bit Descriptions

Bits	Description
[15:0]	Factory programmed CRC value for the calibration coefficients, high word

Derived CRC, Program Code, CODE_DRVTN_LWR

Table 189. CODE_DRVTN_LWR Register Definitions

Page	Addresses	Default	Access	Flash Backup
0x04	0x10, 0x11	Not applicable	R	No

Table 190. CODE_DRVTN_LWR Bit Descriptions

Bits	Description
[15:0]	Calculated CRC value for the calibration coefficients, low word

Derived CRC, Program Code, CODE_DRVTN_UPR

Table 191. CODE_DRVTN_UPR Register Definitions

Page	Addresses	Default	Access	Flash Backup
0x04	0x12, 0x13	Not applicable	R	No

Table 192. CODE_DRVTN_UPR Bit Descriptions

Bits	Description
[15:0]	Calculated CRC value for the calibration coefficients, high word

Lot Specific Serial Number, SERIAL_NUM

Table 193. SERIAL_NUM Register Definitions

Page	Addresses	Default	Access	Flash Backup
0x04	0x20, 0x21	Not applicable	R	Yes

Table 194. SERIAL_NUM Bit Descriptions

Bits	Description
[15:0]	Lot specific serial number

CRC32 CODING EXAMPLE

This section contains sample code and values for computing the cyclic redundancy check (CRC) for the ADIS16497 register readback values.

In this coding example, the 32-bit CRC is first initialized with 0xFFFFFFFF. Next, each 16-bit word passes through the CRC computation in ascending order. Finally, the CRC is XOR'ed with 0xFFFFFFFF.

The ADIS16497 updates the CRC value for each data ready cycle. The registers listed in Table 195 are used as inputs for computing the CRC32 checksum. The registers can either be read individually in normal SPI mode or in burst mode, provided that all registers are all read during the same data ready cycle.

Table 195. Sample Input Data for CRC Computation¹

Register Number	Register	Input Value
1	STATUS	0x0000
2	TEMP_OUT	0x083A
3	X_GYRO_LOW	0x0000
4	X_GYRO_OUT	0xFFFF7
5	Y_GYRO_LOW	0x0000
6	Y_GYRO_OUT	0xFFFE
7	Z_GYRO_LOW	0x0000
8	Z_GYRO_OUT	0x0001
9	X_ACCL_LOW	0x5001
10	X_ACCL_OUT	0x0003
11	Y_ACCL_LOW	0xE00A
12	Y_ACCL_OUT	0x0015
13	Z_ACCL_LOW	0xC009
14	Z_ACCL_OUT	0x0320
15	TIME_STAMP	0x8A54

¹ This information is contained in the array data in the coding example.

Table 196. Output Results for CRC Sample Computation¹

Register Number	Register	Output Value
1	CRC_LWR	0x15B4
2	CRC_UPR	0xB6C8

¹ Based on the input shown in Table 195.

The following is the CRC initialization code:

```

/* Initialize CRC */
crc = 0xFFFFFFFFU;
/* Compute CRC in the order of bytes low-high
starting at 0-14, BurstID, STATUS - TIME_STAMP */
crc = crc32_block(crc, DATA, 15);
/* Final operation per IEEE-802.3 */
crc ^= 0xFFFFFFFFU;
    
```

The crc32_block function accepts an array of 16-bit numbers and computes the CRC byte-by-byte:

```

unsigned long crc32_block( unsigned long crc,
const unsigned short data[], int n )
{
    unsigned long long_c;
    int i;

    /* cycle through memory */
    for ( i=0; i<n; i++ )
    {
        /* Get lower byte */
        long_c = 0x000000ff &
(unsigned long)data[i];
        /* Process with CRC */
        crc = ((crc>>8) & 0x00ffffff) ^
crc_tab32[(crc^long_c)&0xff];
        /* Get upper byte */
        long_c = (0x000000ff &
((unsigned long)data[i]>>8));
        /* Process with CRC */
        crc = ((crc>>8) & 0x00ffffff) ^
crc_tab32[(crc^long_c)&0xff];
    }
    return crc;
}
    
```

The CRC table (crc_tab32) is computed with the following function:

```

void init_crc32_table( void )
{
    unsigned long P_32;
    int i, j;
    unsigned long crc;

    /* CRC32 polynomial defined by IEEE-802.3 */
    P_32 = 0xEDB88320

    /* 8 bits require 256 entries in Table */
    for (i=0; i<256; i++)
    {
        /* start with table entry number */
        crc = (unsigned long) i;

        /* cycle through all bits in entry number */
        for (j=0; j<8; j++)
        {
            /* LSBit set? */
            if ((crc&(unsigned
long)0x00000001)!=0)
            {
                /* process for bit set */
                crc = (crc>>1) ^ P_32;
            }
            else
            {
                /* process for bit clear */
                crc = (crc>>1);
            }
        }
        /* Store calculated value into table */
        crc_tab32[i] = crc;
    }
}
    
```

OUTLINE DIMENSIONS

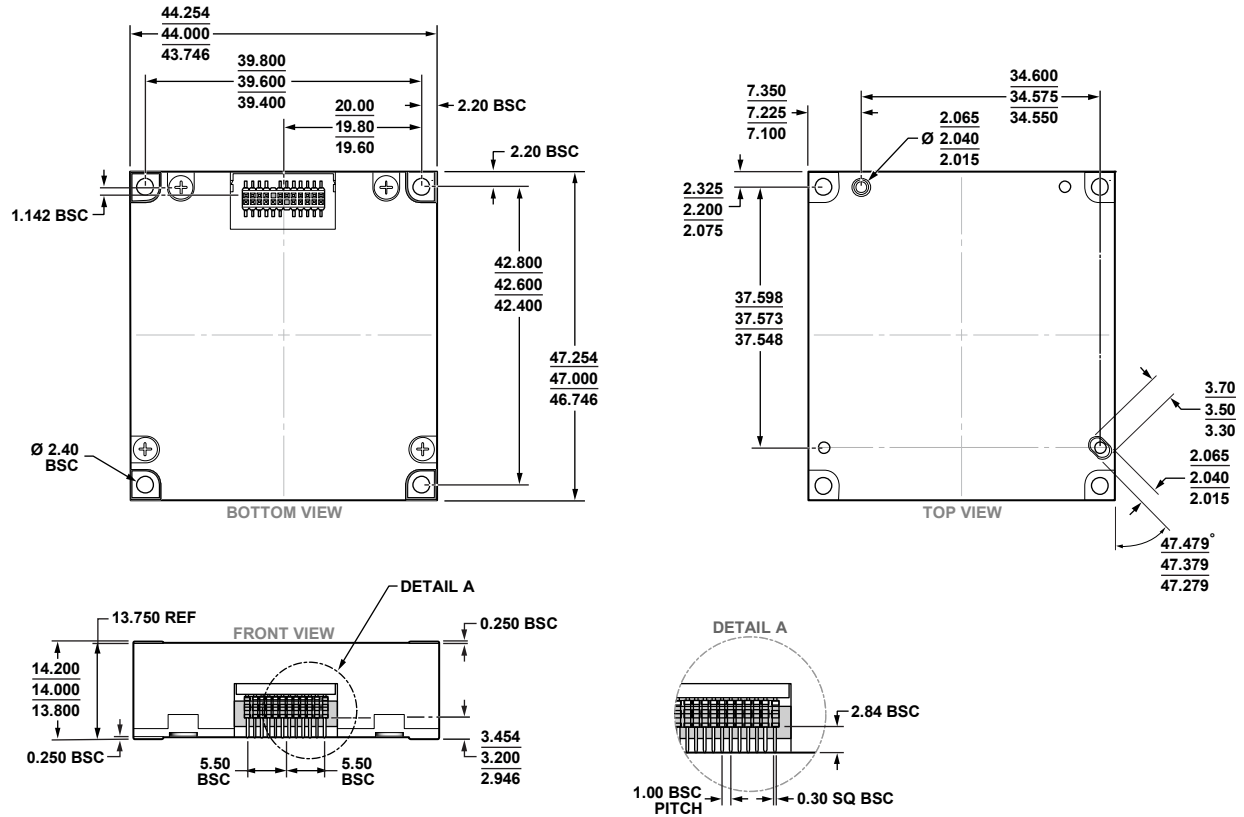

Figure 53. 24-Lead Module with Connector Interface [MODULE] (ML-24-9)
Dimensions shown in millimeters

0.5-31-2018-A

ORDERING GUIDE

Model ¹	Temperature Range	Description	Package Option
ADIS16497-1BMLZ	-40°C to +105°C	24-Lead Module with Connector Interface [MODULE]	ML-24-9
ADIS16497-2BMLZ	-40°C to +105°C	24-Lead Module with Connector Interface [MODULE]	ML-24-9
ADIS16497-3BMLZ	-40°C to +105°C	24-Lead Module with Connector Interface [MODULE]	ML-24-9

¹ Z = RoHS Compliant Part.

Looking for pricing, stock, or lifecycle information?

Click below to explore more details on WIN SOURCE:

 [View ADIS16497-3BMLZ on WIN SOURCE](#)

 [Analog Devices Inc. Information](#)

Optimize Your Supply Chain with WIN SOURCE Solutions

-  Global Sourcing Solution
-  Obsolete Management
-  Cost Control Management
-  Shortage Management
-  Alternative Solution
-  Excess Inventory Management