



**THE DATASHEET OF
AD7405BRIZ**



16-Bit, Isolated Sigma-Delta Modulator, LVDS Interface

FEATURES

- ▶ 5 MHz to 20 MHz external clock input rate
- ▶ 16 bits, no missing codes
- ▶ Signal-to-noise ratio (SNR): 88 dB typical
- ▶ Effective number of bits (ENOB): 14.2 bits typical
- ▶ Typical offset drift vs. temperature: 1.6 $\mu\text{V}/^\circ\text{C}$
- ▶ Low voltage differential signaling (LVDS) interface
- ▶ On-board digital isolator
- ▶ On-board reference
- ▶ Full-scale analog input voltage range: ± 320 mV
- ▶ -40°C to $+125^\circ\text{C}$ operating temperature range
- ▶ High common-mode transient immunity: >25 kV/ μs
- ▶ 16-lead, wide-body SOIC_IC, with increased creepage package
- ▶ Safety and regulatory approvals
 - ▶ UL recognition
 - ▶ 5000 V rms for 1 minute per UL 1577
 - ▶ CSA certification per IEC 62368-1 and IEC 60601-1
 - ▶ VDE Certificate of Conformity
 - ▶ DIN V VDE V 0884-10 (VDE V 0884-10):2006-12
 - ▶ Maximum working insulation voltage (V_{ORM}): 1250 V_{PEAK}

APPLICATIONS

- ▶ Shunt current monitoring
- ▶ AC motor controls
- ▶ Power and solar inverters
- ▶ Wind turbine inverters
- ▶ Data acquisition systems
- ▶ Analog-to-digital and opto-isolator replacements

FUNCTIONAL BLOCK DIAGRAM

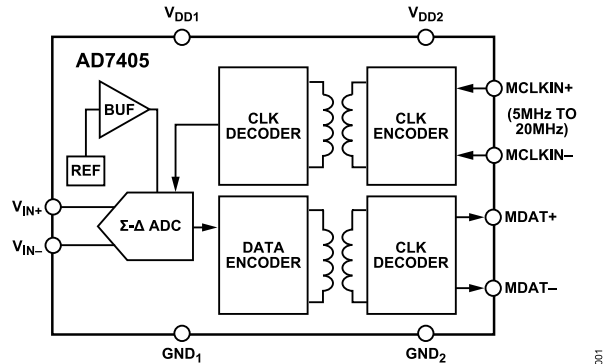

Figure 1.

GENERAL DESCRIPTION

The AD7405¹ is a high performance, second-order, Σ - Δ modulator that converts an analog input signal into a high speed, single-bit LVDS data stream, with on-chip digital isolation based on Analog Devices, Inc., *iCoupler*[®] technology. The AD7405 operates from a 4.5 V to 5.5 V (V_{DD1}) power supply and accepts a differential input signal of ± 250 mV (± 320 mV full-scale). The differential input is ideally suited to shunt voltage monitoring in high voltage applications where galvanic isolation is required.

The analog input is continuously sampled by a high performance analog modulator, and converted to a ones density digital output stream with a data rate of up to 20 MHz. The original information can be reconstructed with an appropriate digital filter to achieve 88 dB SNR at 78.1 kSPS. The LVDS input/output can use a 3 V to 5.5 V supply (V_{DD2}).

The LVDS interface is digitally isolated. The LVDS interface technology, combined with monolithic transformer technology, means the on-chip isolation provides outstanding performance characteristics, superior to alternatives such as optocoupler devices. The AD7405 device is offered in a 16-lead, wide-body SOIC_IC package and has an operating temperature range of -40°C to $+125^\circ\text{C}$.

Analog Devices is in the process of updating documentation to provide terminology and language that is culturally appropriate. This is a process with a wide scope and will be phased in as quickly as possible. Thank you for your patience.

¹ Protected by U.S. Patents 5,952,849; 6,873,065; and 7,075,329.

TABLE OF CONTENTS

Features.....	1	Theory of Operation.....	13
Applications.....	1	Circuit Information.....	13
Functional Block Diagram.....	1	Analog Input.....	13
General Description.....	1	Differential Inputs.....	14
Specifications.....	3	Low Voltage Differential Signaling (LVDS)	
Timing Specifications.....	4	Interface.....	14
Package Characteristics.....	4	Applications Information.....	15
Insulation and Safety Related Specifications.....	5	Current Sensing Applications.....	15
Regulatory Information.....	5	Voltage Sensing Applications.....	15
DIN V VDE V 0884-10 (VDE V		Input Filter.....	15
0884-10):2006-12 Insulation Characteristics.....	5	Digital Filter.....	16
Absolute Maximum Ratings.....	7	Grounding and Layout.....	19
ESD Caution.....	7	Insulation Lifetime.....	19
Pin Configuration and Function Descriptions.....	8	Outline Dimensions.....	20
Typical Performance Characteristics.....	9	Ordering Guide.....	20
Terminology.....	12	Evaluation Boards.....	20

REVISION HISTORY**1/2024—Rev. A to Rev. B**

Changes to Features Section.....	1
Changes to General Description Section.....	1
Changes to Table 5.....	5
Updated Outline Dimensions.....	20
Changes to Evaluation Boards.....	20

SPECIFICATIONS

$V_{DD1} = 4.5\text{ V to }5.5\text{ V}$, $V_{DD2} = 3\text{ V to }5.5\text{ V}$, $V_{IN+} = -250\text{ mV to }+250\text{ mV}$, $V_{IN-} = 0\text{ V}$, $T_A = -40^\circ\text{C to }+125^\circ\text{C}$, $f_{MCLKIN} = 5\text{ MHz to }20\text{ MHz}$, tested with sinc3 filter, 256 decimation rate, as defined by Verilog code, unless otherwise noted. For $f_{MCLKIN} > 16\text{ MHz}$, mark space ratio is 48/52 to 52/48, and $V_{DD1} = 5\text{ V} \pm 5\%$. All voltages are relative to their respective ground.

Table 1.

Parameter	Symbol	Min	Typ	Max	Unit	Test Conditions/Comments
STATIC PERFORMANCE						
Resolution		16			Bits	Filter output truncated to 16 bits
Integral Nonlinearity ¹	INL		±2	±12	LSB	
Differential Nonlinearity ¹	DNL			±0.99	LSB	Guaranteed no missing codes to 16 bits
Offset Error ¹			±0.2	±0.75	mV	
Offset Drift vs. Temperature			1.6	3.8	μV/°C	
			1.3	3.1	μV/°C	0°C to 85°C
Offset Drift vs. V_{DD1}			50		μV/V	
Gain Error ¹			±0.2	±0.8	% FSR	$f_{MCLKIN} = 16\text{ MHz}$
			±0.2	±0.8	% FSR	$f_{MCLKIN} = 20\text{ MHz}$, $T_A = -40^\circ\text{C to }+85^\circ\text{C}$
			±0.2	±1.2	% FSR	$f_{MCLKIN} = 20\text{ MHz}$
Gain Error Drift vs. Temperature			65	95	ppm/°C	
			40	60	μV/°C	
Gain Error Drift vs. V_{DD1}			±0.6		mV/V	
ANALOG INPUT						
Input Voltage Range		-320		+320	mV	Full-scale range
		-250		+250	mV	For specified performance
Input Common-Mode Voltage Range			-200 to +300		mV	
Dynamic Input Current			±45	±50	μA	$V_{IN+} = \pm 250\text{ mV}$, $V_{IN-} = 0\text{ V}$
			0.05		μA	$V_{IN+} = 0\text{ V}$, $V_{IN-} = 0\text{ V}$
DC Leakage Current			±0.01	±0.6	μA	
Input Capacitance			14		pF	
DYNAMIC SPECIFICATIONS						
Signal-to-Noise-and-Distortion Ratio ¹	SINAD	81	87		dB	$V_{IN+} = 1\text{ kHz}$
		83	87		dB	-40°C to +85°C
Signal-to-Noise Ratio ¹	SNR	86	88		dB	
Total Harmonic Distortion ¹	THD		-96		dB	
Peak Harmonic or Spurious Noise ¹	SFDR		-97		dB	
Effective Number of Bits ¹	ENOB	13.1	14.2		Bits	
		13.4	14.2		Bits	-40°C to +85°C
Noise Free Code Resolution ¹		14			Bits	
ISOLATION TRANSIENT IMMUNITY¹						
		25	30		kV/μs	
LVDS I/O (ANSI-644)						
Differential Output Voltage	V_{OD}	247	360	454	mV	$R_L = 100\ \Omega$
Common-Mode Output Voltage	V_{OCM}	1125	1260	1375	mV	$R_L = 100\ \Omega$
Differential Input Voltage	V_{ID}	150		650	mV	
Common-Mode Input Voltage	V_{ICM}	800		1575	mV	
POWER REQUIREMENTS						
V_{DD1}		4.5		5.5	V	
V_{DD2}		3		5.5	V	
I_{DD1}			30	36	mA	$V_{DD1} = 5.5\text{ V}$
I_{DD2}			18	22	mA	$V_{DD2} = 5.5\text{ V}$
			13	15	mA	$V_{DD2} = 3.3\text{ V}$

SPECIFICATIONS

Table 1. (Continued)

Parameter	Symbol	Min	Typ	Max	Unit	Test Conditions/Comments
Power Dissipation			264	319	mW	$V_{DD1} = V_{DD2} = 5.5\text{ V}$
			208	248	mW	$V_{DD1} = 5.5\text{ V}, V_{DD2} = 3.3\text{ V}$

¹ See the Terminology section.

TIMING SPECIFICATIONS

$V_{DD1} = 4.5\text{ V to }5.5\text{ V}$, $V_{DD2} = 3\text{ V to }5.5\text{ V}$, $T_A = -40^\circ\text{C to }+125^\circ\text{C}$, unless otherwise noted. Sample tested during initial release to ensure compliance. It is recommended to read the MDAT signal on the MCLKIN+ rising edge.

Table 2.

Parameter ¹	Limit at T_{MIN}, T_{MAX}	Unit	Description
f_{MCLKIN}	5	MHz minimum	Master clock input frequency
	20	MHz maximum	
t_1	30	ns maximum	Data access time after MCLKIN+ rising edge $V_{DD2} = 4.5\text{ V to }5.5\text{ V}$
	40	ns maximum	$V_{DD2} = 3\text{ V to }3.6\text{ V}$
t_2	10	ns minimum	Data hold time after MCLKIN+ rising edge $V_{DD2} = 4.5\text{ V to }5.5\text{ V}$
	10	ns minimum	$V_{DD2} = 3\text{ V to }3.6\text{ V}$
t_3	$0.45 \times t_{MCLKIN}$	ns minimum	Master clock low time $f_{MCLKIN} \leq 16\text{ MHz}$
	$0.48 \times t_{MCLKIN}$	ns minimum	$16\text{ MHz} < f_{MCLKIN} \leq 20\text{ MHz}$
t_4	$0.45 \times t_{MCLKIN}$	ns minimum	Master clock high time $f_{MCLKIN} \leq 16\text{ MHz}$
	$0.48 \times t_{MCLKIN}$	ns minimum	$16\text{ MHz} < f_{MCLKIN} \leq 20\text{ MHz}$

¹ Sample tested during initial release to ensure compliance.

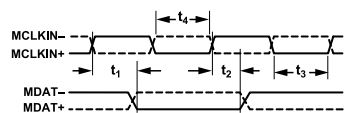

Figure 2. Data Timing

PACKAGE CHARACTERISTICS

Table 3.

Parameter	Symbol	Min	Typ	Max	Unit	Test Conditions/Comments
Resistance (Input to Output) ¹	R_{I-O}		10^{12}		Ω	
Capacitance (Input to Output) ¹	C_{I-O}		2.2		pF	$f = 1\text{ MHz}$
IC Junction to Ambient Thermal Resistance	θ_{JA}		45		$^\circ\text{C/W}$	Thermocouple located at center of package underside, test conducted on 4-layer board with thin traces

¹ The device is considered a 2-terminal device: Pin 1 to Pin 8 are shorted together, and Pin 9 to Pin 16 are shorted together.

SPECIFICATIONS

INSULATION AND SAFETY RELATED SPECIFICATIONS

Table 4.

Parameter	Symbol	Value	Unit	Test Conditions/Comments
Input to Output Momentary Withstand Voltage	V _{ISO}	5000 min	V	1 minute duration
Minimum External Air Gap (Clearance)	L(I01)	8.3 min ^{1, 2}	mm	Measured from input terminals to output terminals, shortest distance through air
Minimum External Tracking (Creepage)	L(I02)	8.3 min ¹	mm	Measured from input terminals to output terminals, shortest distance path along body
Minimum Internal Gap (Internal Clearance)		0.034 min	mm	Distance through insulation
Tracking Resistance (Comparative Tracking Index)	CTI	>400	V	DIN IEC 112/VDE 0303 Part 1 ³
Isolation Group		II		Material Group (DIN VDE 0110, 1/89, Table I) ³

¹ In accordance with IEC 60950-1 guidelines for the measurement of creepage and clearance distances for a pollution degree of 2 and altitudes ≤2000 meters.

² Consideration must be given to pad layout to ensure the minimum required distance for clearance is maintained.

³ CSA CTI rating for the AD7405 is >600 V and a Material Group I isolation group.

REGULATORY INFORMATION

Table 5.

UL ¹	CSA	VDE ²
Recognized under 1577 Component Recognition Program ¹	Approved under CSA Component Acceptance	Certified according to DIN V VDE V 0884-10 (VDE V 0884-10):2006-12 ²
5000 V rms Isolation Voltage Single Protection	CSA 62368-1:19, IEC 62368-1:2018 Edition 3, and EN 62368-1:2020+A11:2020 Basic insulation at 870 V rms (1230 V _{PEAK}) Reinforced insulation at 435 V rms (615 V _{PEAK}) ³ CSA 60601-1:14 and IEC 60601-1 Edition 3+A1 Basic insulation (1 means of patient protection (1MOPP)), 500 V rms (707 V peak) Reinforced insulation (2 means of patient protection (2MOPP)), 50 V rms (71 V _{PEAK})	Reinforced insulation per DIN V VDE V 0884-10 (VDE V 0884-10):2006-12, 1250 V _{PEAK}
File E214100	File 205078	File 2471900-4880-0001

¹ In accordance with UL 1577, each AD7405 is proof tested by applying an insulation test voltage ≥6000 V rms for 1 second (current leakage detection limit = 15 μA).

² In accordance with DIN V VDE V 0884-10, each AD7405 is proof tested by applying an insulation test voltage of ≥2344 V_{PEAK} for 1 second (partial discharge detection limit = 5 pC).

³ Rating is calculated for a pollution degree of 2 and a Material Group III. The AD7405 RI-16-2 package material is rated by CSA to a CTI of >600 V and, therefore, Material Group I.

DIN V VDE V 0884-10 (VDE V 0884-10):2006-12 INSULATION CHARACTERISTICS

This isolator is suitable for reinforced electrical isolation only within the safety limit data. Maintenance of the safety data is ensured by means of protective circuits.

Table 6.

Description	Symbol	Characteristic	Unit
INSTALLATION CLASSIFICATION PER DIN VDE 0110			
For Rated Mains Voltage ≤300 V rms		I to IV	
For Rated Mains Voltage ≤450 V rms		I to IV	
For Rated Mains Voltage ≤600 V rms		I to IV	
For Rated Mains Voltage ≤1000 V rms		I to IV	

SPECIFICATIONS

Table 6. (Continued)

Description	Symbol	Characteristic	Unit
CLIMATIC CLASSIFICATION		40/105/21	
POLLUTION DEGREE (DIN VDE 0110, TABLE 1)		2	
MAXIMUM WORKING INSULATION VOLTAGE	V_{IORM}	1250	V_{PEAK}
INPUT TO OUTPUT TEST VOLTAGE, METHOD B1 $V_{IORM} \times 1.875 = V_{PR}$, 100% Production Test, $t_m = 1$ Second, Partial Discharge < 5 pC	$V_{PD(M)}$	2344	V_{PEAK}
INPUT TO OUTPUT TEST VOLTAGE, METHOD A After Environmental Test Subgroup 1 $V_{IORM} \times 1.6 = V_{PR}$, $t_m = 60$ Seconds, Partial Discharge < 5 pC After Input and/or Safety Test Subgroup 2/ Safety Test Subgroup 3 $V_{IORM} \times 1.2 = V_{PR}$, $t_m = 60$ Seconds, Partial Discharge < 5 pC	$V_{PR(M)}$	2000 1500	V_{PEAK} V_{PEAK}
HIGHEST ALLOWABLE OVERVOLTAGE (TRANSIENT OVERVOLTAGE, $t_{TR} = 10$ Seconds)	V_{IOTM}	8000	V_{PEAK}
SURGE ISOLATION VOLTAGE 1.2 μ s Rise Time, 50 μ s, 50% Fall Time	V_{IOSM}	12000	V_{PEAK} V_{PEAK}
SAFETY LIMITING VALUES (MAXIMUM VALUE ALLOWED IN THE EVENT OF A FAILURE, SEE Figure 3) Case Temperature	T_S	150	$^{\circ}C$
Side 1 (P_{VDD1}) and Side 2 (P_{VDD2}) Power Dissipation	P_{SO}	2.78	W
INSULATION RESISTANCE AT T_S , $V_{IO} = 500$ V	R_{IO}	$>10^9$	Ω

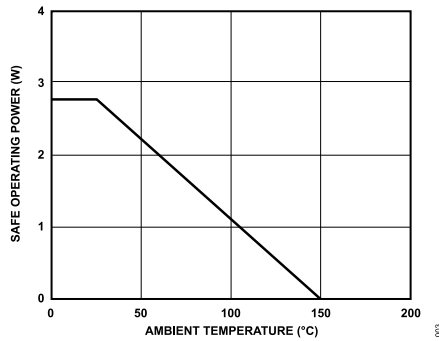

Figure 3. Thermal Derating Curve, Dependence of Safety Limiting Values with Case Temperature per DIN V VDE V 0884-10

ABSOLUTE MAXIMUM RATINGS

$T_A = 25^\circ\text{C}$, unless otherwise noted. All voltages are relative to their respective ground.

Table 7.

Parameter	Rating
V_{DD1} to GND ₁	-0.3 V to +6.5 V
V_{DD2} to GND ₂	-0.3 V to +6.5 V
Analog Input Voltage to GND ₁	-1 V to $V_{DD1} + 0.3$ V
Digital Input Voltage to GND ₂	-0.3 V to $V_{DD2} + 0.5$ V
Output Voltage to GND ₂	-0.3 V to $V_{DD2} + 0.3$ V
Input Current to Any Pin Except Supplies ¹	±10 mA
Operating Temperature Range	-40°C to +125°C
Storage Temperature Range	-65°C to +150°C
Junction Temperature	150°C
Pb-Free Temperature, Soldering	
Reflow	260°C
ESD	2 kV
FICDM ²	±1250 V
HBM ³	±4000 V

¹ Transient currents of up to 100 mA do not cause silicon controlled rectifier (SCR) to latch up.

² JESD22-C101; RC Network: 1 Ω, Cpkg; Class: IV.

³ ESDA/JEDEC JS-001-2011; RC Network: 1.5 kΩ, 100 pF; Class: 3A.

Stresses at or above those listed under Absolute Maximum Ratings may cause permanent damage to the product. This is a stress rating only; functional operation of the product at these or any other conditions above those indicated in the operational section of this specification is not implied. Operation beyond the maximum operating conditions for extended periods may affect product reliability.

Table 8. Maximum Continuous Working Voltage¹

Parameter	Max (V_{PEAK})	Constraint
AC Voltage		
Bipolar Waveform	1250	20-year minimum lifetime (VDE approved working voltage)
Unipolar Waveform	1250	20-year minimum lifetime
DC Voltage	1250	20-year minimum lifetime

¹ Refers to continuous voltage magnitude imposed across the isolation barrier.

ESD CAUTION

ESD (electrostatic discharge) sensitive device. Charged devices and circuit boards can discharge without detection. Although this product features patented or proprietary protection circuitry, damage may occur on devices subjected to high energy ESD. Therefore, proper ESD precautions should be taken to avoid performance degradation or loss of functionality.

PIN CONFIGURATION AND FUNCTION DESCRIPTIONS

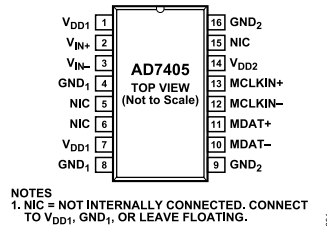

Figure 4. Pin Configuration

Table 9. Pin Function Descriptions

Pin No.	Mnemonic	Description
1, 7	V_{DD1}	Supply Voltage, 4.5 V to 5.5 V. This pin is the supply voltage for the isolated side of the AD7405 and is relative to GND_1 . For device operation, connect the supply voltage to both Pin 1 and Pin 7. Decouple each supply pin to GND_1 with a 10 μ F capacitor in parallel with a 1 nF capacitor.
2	V_{IN+}	Positive Analog Input.
3	V_{IN-}	Negative Analog Input. Normally connected to GND_1 .
4, 8	GND_1	Ground 1. This pin is the ground reference point for all circuitry on the isolated side.
5, 6, 15	NIC	Not Internally Connected. Connect to V_{DD1} , GND_1 , or leave floating.
9, 16	GND_2	Ground 2. This pin is the ground reference point for all circuitry on the nonisolated side.
10, 11	MDAT-, MDAT+	LVDS Data Outputs. The conversion data is output serially on these pins.
12, 13	MCLKIN-, MCLKIN+	LVDS Clock Inputs. Conversion results are shifted out on the rising edge of MCLKIN+.
14	V_{DD2}	Supply Voltage, 3 V to 5.5 V. This pin is the supply voltage for the nonisolated side and is relative to GND_2 . Decouple this supply to GND_2 with a 100 nF capacitor.

TYPICAL PERFORMANCE CHARACTERISTICS

$T_A = 25^\circ\text{C}$, $V_{DD1} = 5\text{ V}$, $V_{DD2} = 5\text{ V}$, $V_{IN+} = -250\text{ mV}$ to $+250\text{ mV}$, $V_{IN-} = 0\text{ V}$, $f_{MCLKIN} = 20\text{ MHz}$, using a sinc3 filter with a 256 oversampling ratio (OSR), unless otherwise noted.

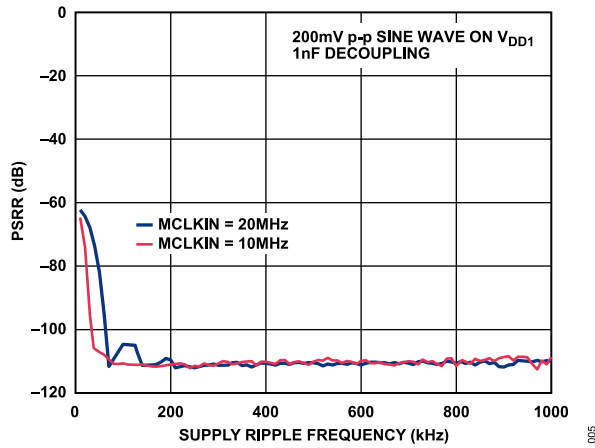

Figure 5. PSRR vs. Supply Ripple Frequency

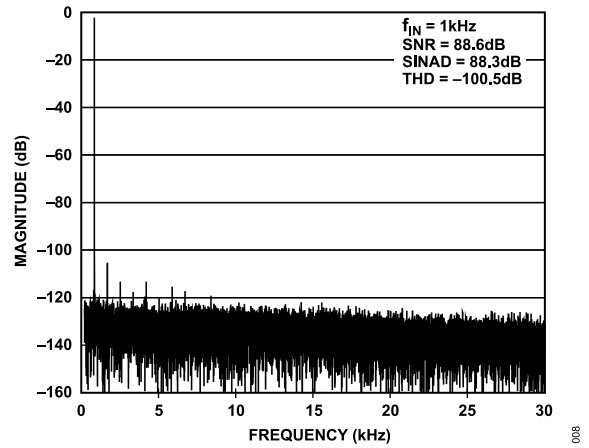

Figure 8. Typical Fast Fourier Transform (FFT)

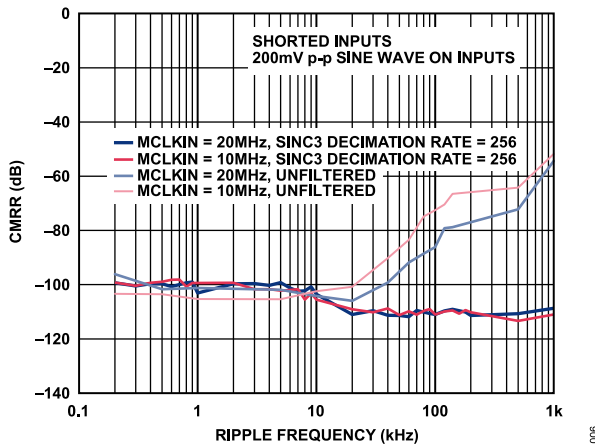

Figure 6. CMRR vs. Common-Mode Ripple Frequency

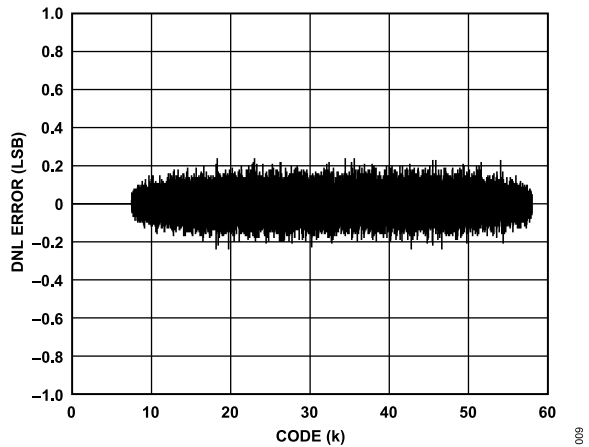

Figure 9. Typical DNL Error

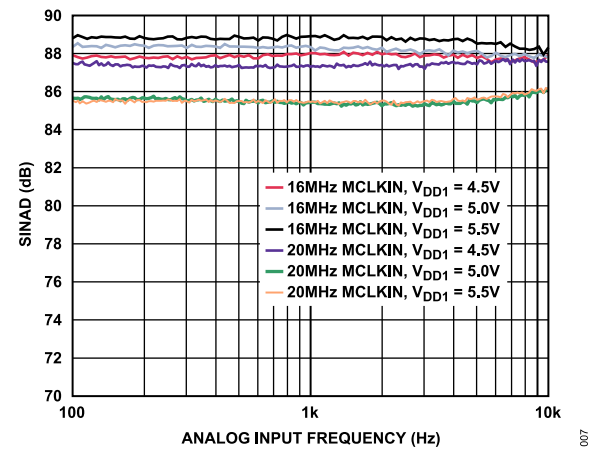

Figure 7. SINAD vs. Analog Input Frequency

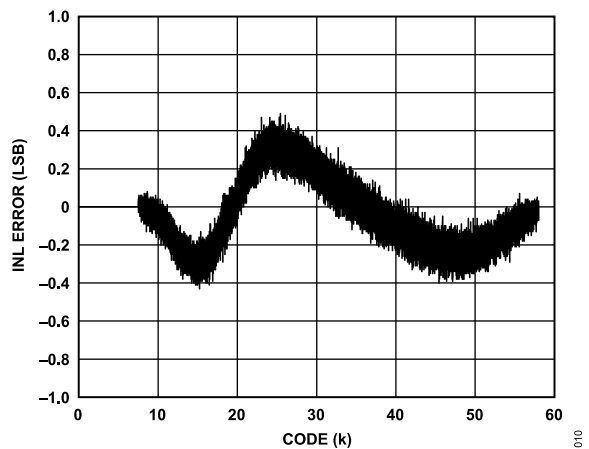

Figure 10. Typical INL Error

TYPICAL PERFORMANCE CHARACTERISTICS

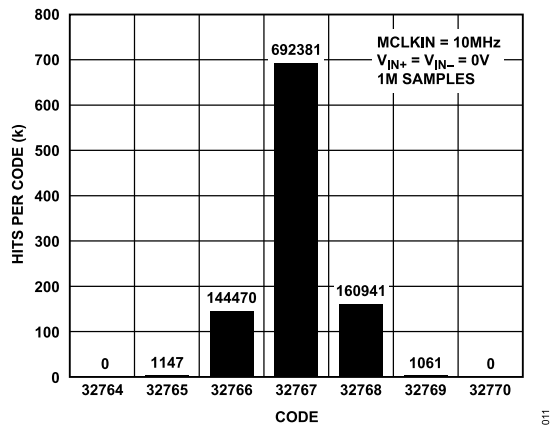

Figure 11. Histogram of Codes at Code Center

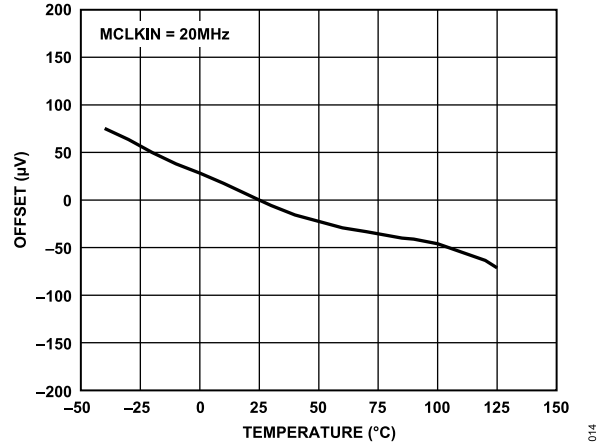

Figure 14. Offset vs. Temperature

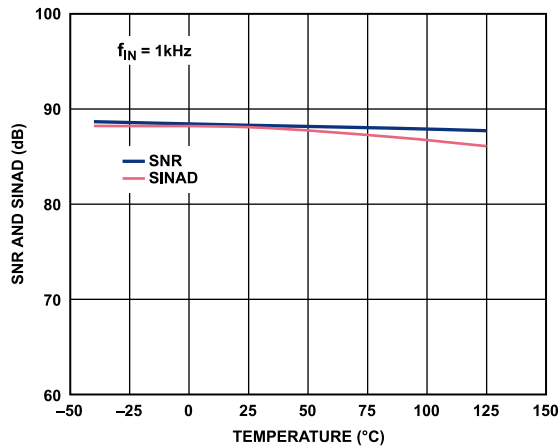

Figure 12. SNR and SINAD vs. Temperature

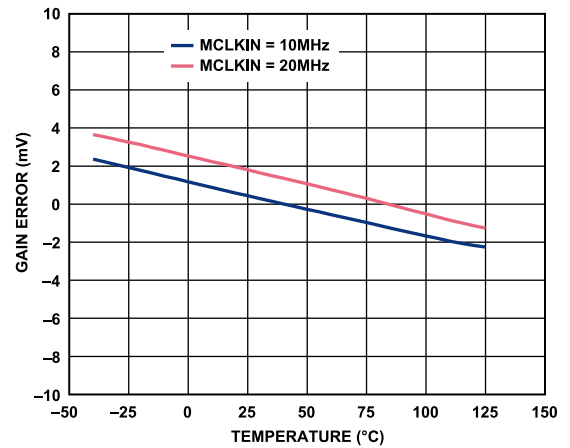

Figure 15. Gain Error vs. Temperature

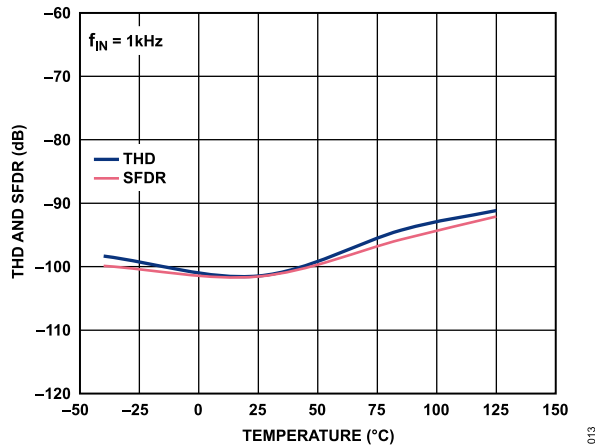

Figure 13. THD and SFDR vs. Temperature

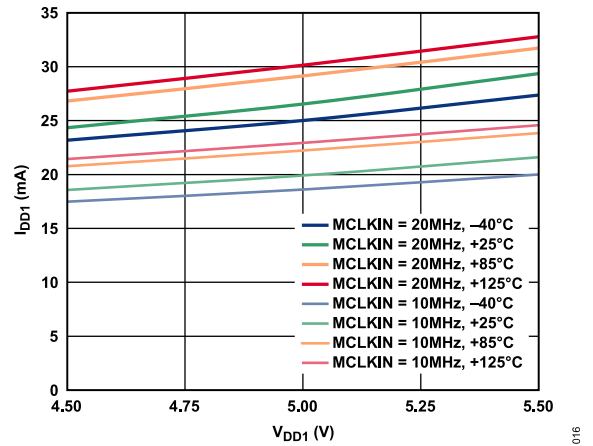

Figure 16. I_{DD1} vs. V_{DD1} at Various Temperatures and Clock Rates

TYPICAL PERFORMANCE CHARACTERISTICS

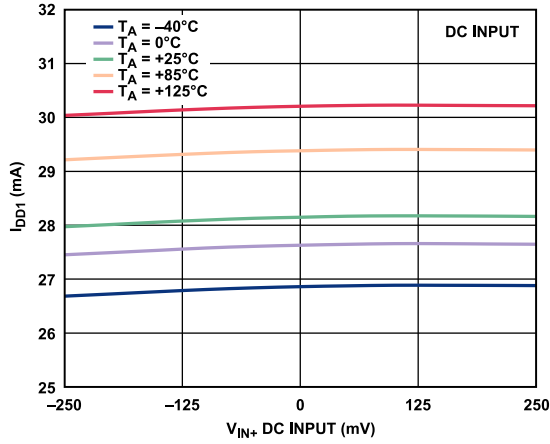

Figure 17. I_{DD1} vs. V_{IN+} DC Input at Various Temperatures

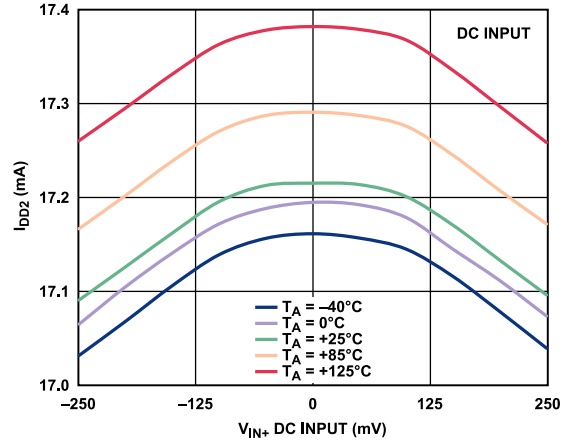

Figure 19. I_{DD2} vs. V_{IN+} DC Input at Various Temperatures

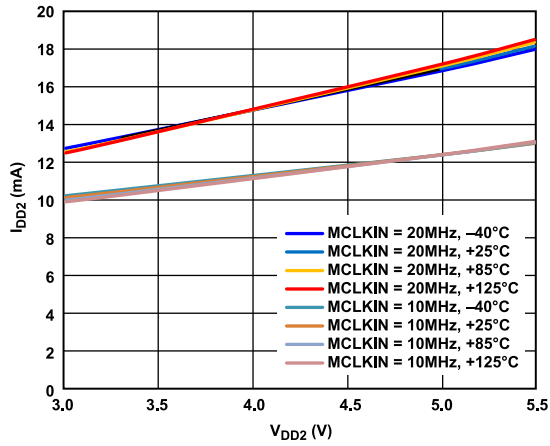

Figure 18. I_{DD2} vs. V_{DD2} at Various Temperatures and Clock Rates

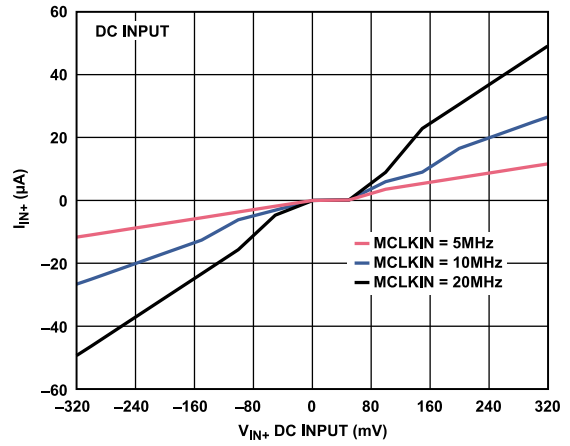

Figure 20. I_{IN+} vs. V_{IN+} DC Input at Various Clock Rates

TERMINOLOGY

Differential Nonlinearity (DNL)

DNL is the difference between the measured and the ideal 1 LSB change between any two adjacent codes in the ADC.

Integral Nonlinearity (INL)

INL is the maximum deviation from a straight line passing through the endpoints of the ADC transfer function. The endpoints of the transfer function are a specified negative full scale, -250 mV ($V_{\text{IN}+} - V_{\text{IN}-}$), Code 7168 for the 16-bit level, and a specified positive full scale, $+250\text{ mV}$ ($V_{\text{IN}+} - V_{\text{IN}-}$), Code 58,368 for the 16-bit level.

Offset Error

Offset error is the deviation of the midscale code (32,768 for the 16-bit level) from the ideal $V_{\text{IN}+} - V_{\text{IN}-}$ (that is, 0 V).

Gain Error

The gain error includes both positive full-scale gain error and negative full-scale gain error. Positive full-scale gain error is the deviation of the specified positive full-scale code (58,368 for the 16-bit level) from the ideal $V_{\text{IN}+} - V_{\text{IN}-}$ (250 mV) after the offset error is adjusted out. Negative full-scale gain error is the deviation of the specified negative full-scale code (7168 for the 16-bit level) from the ideal $V_{\text{IN}+} - V_{\text{IN}-}$ (-250 mV) after the offset error is adjusted out.

Signal-to-Noise-and-Distortion Ratio (SINAD)

SINAD is the measured ratio of signal-to-noise-and-distortion at the output of the ADC. The signal is the rms value of the sine wave, and noise is the rms sum of all nonfundamental signals up to half the sampling frequency ($f_s/2$), including harmonics, but excluding dc.

Signal-to-Noise Ratio (SNR)

SNR is the measured signal-to-noise ratio at the output of the ADC. The signal is the rms amplitude of the fundamental. Noise is the sum of all nonfundamental signals up to half the sampling frequency ($f_s/2$), excluding dc.

The ratio is dependent on the number of quantization levels in the digitization process: the greater the number of levels, the smaller the quantization noise. The theoretical SNR for an ideal N-bit converter with a sine wave input is given by

$$\text{Signal-to-Noise Ratio} = (6.02N + 1.76)\text{ dB} \quad (1)$$

Therefore, for a 12-bit converter, the SNR is 74 dB.

Isolation Transient Immunity

The isolation transient immunity specifies the rate of rise and fall of a transient pulse applied across the isolation boundary, beyond which clock or data is corrupted. The AD7405 was tested using a transient pulse frequency of 100 kHz.

Total Harmonic Distortion (THD)

THD is the ratio of the rms sum of harmonics to the fundamental. For the AD7405, it is defined as

$$\text{THD}(\text{dB}) = 20 \log \frac{\sqrt{V_2^2 + V_3^2 + V_4^2 + V_5^2 + V_6^2}}{V_1} \quad (2)$$

where:

V_1 is the rms amplitude of the fundamental.

$V_2, V_3, V_4, V_5,$ and V_6 are the rms amplitudes of the second through the sixth harmonics.

Peak Harmonic or Spurious Noise

Peak harmonic or spurious noise is defined as the ratio of the rms value of the next largest component in the ADC output spectrum (up to $f_s/2$, excluding dc) to the rms value of the fundamental. Normally, the value of this specification is determined by the largest harmonic in the spectrum, but for ADCs where the harmonics are buried in the noise floor, it is a noise peak.

Effective Number of Bits (ENOB)

ENOB is defined by

$$\text{ENOB} = (\text{SINAD} - 1.76)/6.02 \text{ bits} \quad (3)$$

Noise Free Code Resolution

Noise free code resolution represents the resolution in bits for which there is no code flicker. The noise free code resolution for an N-bit converter is defined as

$$\text{Noise Free Code Resolution (Bits)} = \log_2(2^N/\text{Peak-to-Peak Noise}) \quad (4)$$

The peak-to-peak noise in LSBs is measured with $V_{\text{IN}+} = V_{\text{IN}-} = 0\text{ V}$.

Common-Mode Rejection Ratio (CMRR)

CMRR is defined as the ratio of the power in the ADC output at $\pm 250\text{ mV}$ frequency, f , to the power of a $+250\text{ mV}$ peak-to-peak sine wave applied to the common-mode voltage of $V_{\text{IN}+}$ and $V_{\text{IN}-}$ of frequency, f_s , as

$$\text{CMRR}(\text{dB}) = 10 \log(P_f/P_{f_s}) \quad (5)$$

where:

P_f is the power at frequency, f , in the ADC output.

P_{f_s} is the power at frequency, f_s , in the ADC output.

Power Supply Rejection Ratio (PSRR)

Variations in power supply affect the full-scale transition but not the linearity of the converter. PSRR is the maximum change in the specified full-scale ($\pm 250\text{ mV}$) transition point due to a change in power supply voltage from the nominal value.

THEORY OF OPERATION

CIRCUIT INFORMATION

The AD7405 isolated Σ - Δ modulator converts an analog input signal into a high speed (20 MHz maximum), single-bit data stream; the time average single-bit data from the modulator is directly proportional to the input signal. Figure 21 shows a typical application circuit where the AD7405 is used to provide isolation between the analog input, a current sensing resistor or shunt, and the digital output, which is then processed by a digital filter to provide an N-bit word.

ANALOG INPUT

The differential analog input of the AD7405 is implemented with a switched capacitor circuit. This circuit implements a second-order modulator stage that digitizes the input signal into a single-bit output stream. The sample clock (MCLKIN) provides the clock signal for the conversion process as well as the output data framing clock. This clock source is external on the AD7405. The analog input signal is continuously sampled by the modulator and compared to an internal voltage reference. A digital stream that accurately represents the analog input over time appears at the output of the converter (see Figure 22).

A differential input signal of 0 V ideally results in a differential stream of alternating 1s and 0s at the MDAT \pm output pins. This output is high 50% of the time and low 50% of the time. A differential input of 250 mV produces a stream of 1s and 0s that are high 89.06% of the time. A differential input of -250 mV produces a stream of 1s and 0s that are high 10.94% of the time.

A differential input of 320 mV ideally results in a stream of all 1s. A differential input of -320 mV ideally results in a stream of all 0s. The absolute full-scale range is \pm 320 mV, and the specified full-scale performance range is \pm 250 mV, as shown in Table 10.

Table 10. Analog Input Range

Analog Input	Voltage Input (mV)
Positive Full-Scale Value	+320
Positive Specified Performance Input	+250
Zero	0
Negative Specified Performance Input	-250
Negative Full-Scale Value	-320

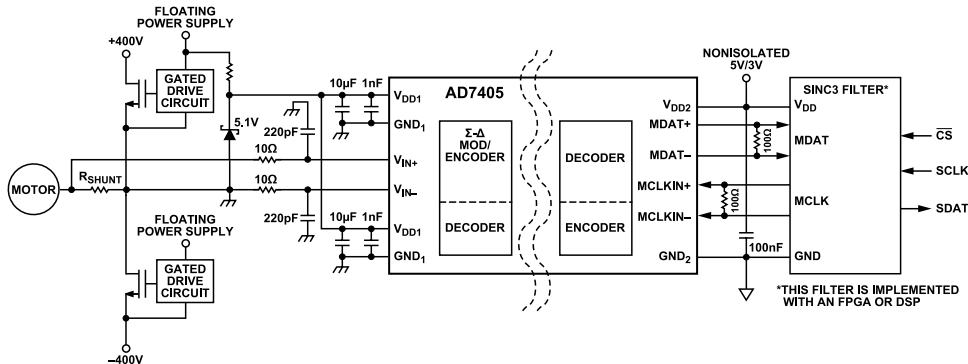

Figure 21. Typical Application Circuit

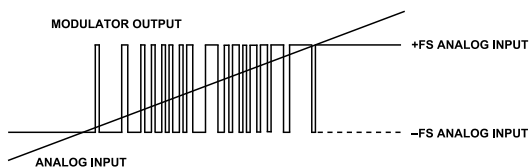

Figure 22. Analog Input vs. Modulator Output

THEORY OF OPERATION

To reconstruct the original information, this output must be digitally filtered and decimated. A sinc3 filter is recommended because it is one order higher than that of the AD7405 modulator, which is a second-order modulator. If a 256 decimation rate is used, the resulting 16-bit word rate is 78.1 kSPS, assuming a 20 MHz external clock frequency. See the [Digital Filter](#) section for more detailed information on the sinc filter implementation. [Figure 23](#) shows the transfer function of the AD7405 relative to the 16-bit output.

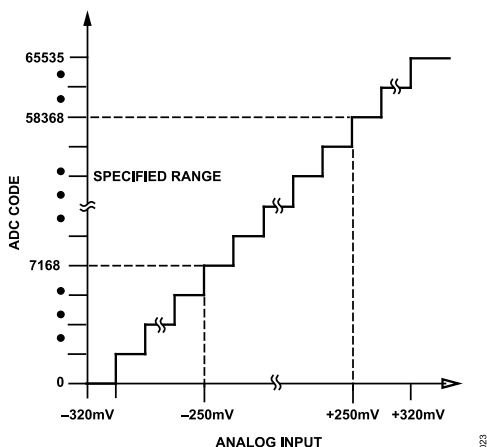

Figure 23. Filtered and Decimated 16-Bit Transfer Function

DIFFERENTIAL INPUTS

The analog input to the modulator is a switched capacitor design. The analog signal is converted into charge by highly linear sampling capacitors. A simplified equivalent circuit diagram of the analog input is shown in [Figure 24](#). A signal source driving the analog input

must provide the charge onto the sampling capacitors every half MCLKIN cycle and settle to the required accuracy within the next half cycle.

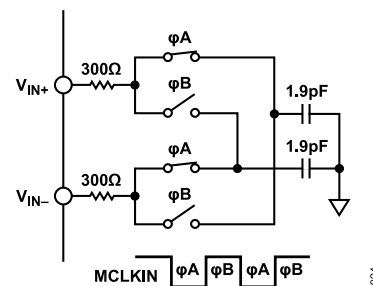

Figure 24. Analog Input Equivalent Circuit

Because the AD7405 samples the differential voltage across its analog inputs, an input circuit provides low common-mode noise at each input attaining low noise performance.

LOW VOLTAGE DIFFERENTIAL SIGNALING (LVDS) INTERFACE

The AD7405 uses an LVDS interface for both the clock input and the modulator output. The benefits of using LVDS in this case helps to make the interface between the modulator and the controller more robust and less susceptible to electromagnetic interference (EMI) from the surroundings. LVDS also helps to reduce the EMI emissions associated with high speed digital signaling. LVDS signals are treated like transmission lines and must be resistively terminated. The value of the differential terminating resistor is typically 100 Ω. Place the terminating resistor as close to the receiver as possible.

APPLICATIONS INFORMATION

CURRENT SENSING APPLICATIONS

The AD7405 is ideally suited for current sensing applications where the voltage across a shunt resistor (R_{SHUNT}) is monitored. The load current flowing through an external shunt resistor produces a voltage at the input terminals of the AD7405. The AD7405 provides isolation between the analog input from the current sensing resistor and the digital outputs. By selecting the appropriate shunt resistor value, a variety of current ranges can be monitored.

Choosing R_{SHUNT}

The shunt resistor (R_{SHUNT}) values used in conjunction with the AD7405 are determined by the specific application requirements in terms of voltage, current, and power. Small resistors minimize power dissipation, whereas low inductance resistors prevent any induced voltage spikes, and good tolerance devices reduce current variations. The final values chosen are a compromise between low power dissipation and accuracy. Higher value resistors use the full performance input range of the ADC, thus achieving maximum SNR performance. Low value resistors dissipate less power but do not use the full performance input range. The AD7405, however, delivers excellent performance, even with lower input signal levels, allowing low value shunt resistors to be used while maintaining system performance.

To choose a suitable shunt resistor, first determine the current through the shunt. The shunt current for a 3-phase induction motor can be expressed as

$$I_{RMS} = \frac{P_W}{1.73 \times V \times EF \times PF} \quad (6)$$

where:

I_{RMS} is the motor phase current (A rms).

P_W is the motor power (Watts).

V is the motor supply voltage (V ac).

EF is the motor efficiency (%).

PF is the power efficiency (%).

To determine the shunt peak sense current, I_{SENSE} , consider the motor phase current and any overload that may be possible in the system. When the peak sense current is known, divide the voltage range of the AD7405 (± 250 mV) by the peak sense current to yield a maximum shunt value.

If the power dissipation in the shunt resistor is too large, the shunt resistor can be reduced and less of the ADC input range can be used. Figure 25 shows the SINAD performance characteristics and the ENOB of resolution for the AD7405 for different input signal amplitudes. Figure 26 shows the rms noise performance for dc input signal amplitudes. The AD7405 performance at lower input signal ranges allows smaller shunt values to be used while still maintaining a high level of performance and overall system efficiency.

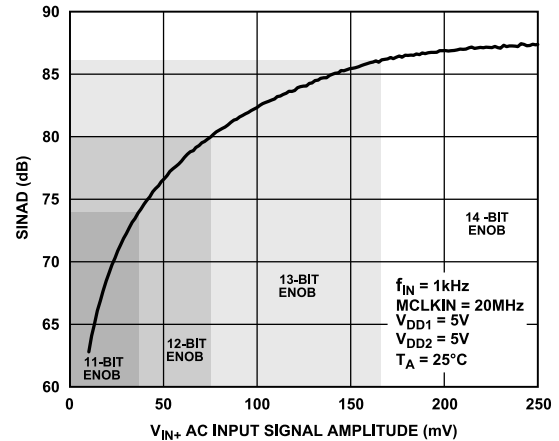

Figure 25. SINAD vs. V_{IN+} AC Input Signal Amplitude

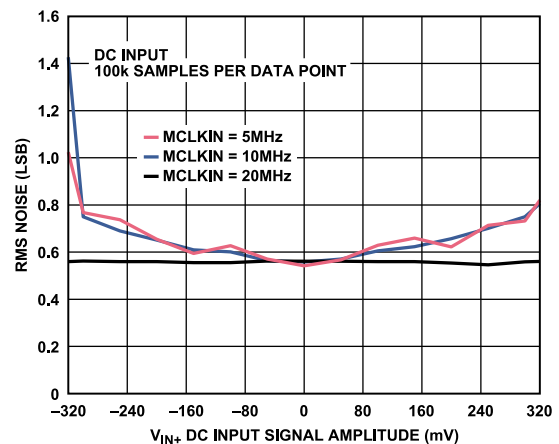

Figure 26. RMS Noise vs. V_{IN+} DC Input Signal Amplitude

R_{SHUNT} must be able to dissipate the I^2R power losses. If the power dissipation rating of the resistor is exceeded, its value may drift or the resistor may be damaged, resulting in an open circuit. This open circuit can result in a differential voltage across the terminals of the AD7405, in excess of the absolute maximum ratings. If I_{SENSE} has a large, high frequency component, choose a resistor with low inductance.

VOLTAGE SENSING APPLICATIONS

The AD7405 can also be used for isolated voltage monitoring. For example, in motor control applications, it can be used to sense the bus voltage. In applications where the voltage being monitored exceeds the specified analog input range of the AD7405, a voltage divider network can be used to reduce the voltage being monitored to the required range.

INPUT FILTER

In a typical application, where voltage is being measured across a shunt resistor, connect the AD7405 directly across the shunt resistor with a simple RC low-pass filter on each input.

APPLICATIONS INFORMATION

The recommended circuit configuration for driving the differential inputs to achieve best performance is shown in Figure 27. An RC low-pass filter is placed on both the analog input pins. Recommended values for the resistors and capacitors are 10 Ω and 220 pF, respectively. If possible, equalize the source impedance on each analog input to minimize offset.

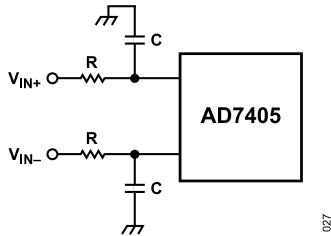

Figure 27. RC Low-Pass Filter Input Network

The input filter configuration for the AD7405 is not limited to the low-pass structure shown in Figure 27. The differential RC filter configuration shown in Figure 28 also achieves excellent performance. Recommended values for the resistors and capacitor are 22 Ω and 47 pF, respectively.

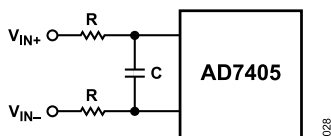

Figure 28. Differential RC Filter Input Network

Figure 29 compares the typical performance for the input filter structures outlined in Figure 27 and Figure 28 for different resistor and capacitor values.

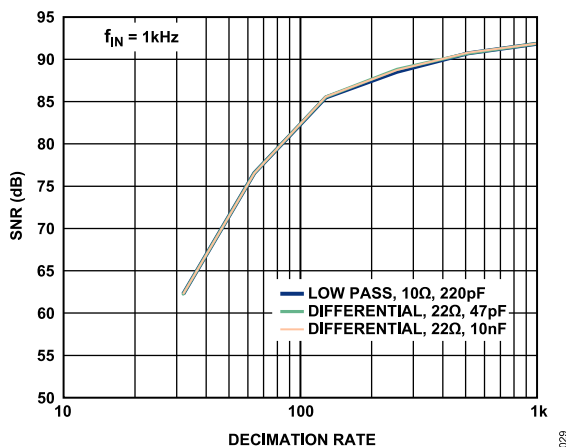

Figure 29. SNR vs. Decimation Rate for Different Filter Structures for Different Resistor and Capacitor Values

DIGITAL FILTER

The output of the AD7405 is a continuous LVDS digital bit stream. To reconstruct the original input signal information, this output bit stream needs to be digitally filtered and decimated. A sinc filter is

recommended due to its simplicity. A sinc3 filter is recommended because it is one order higher than that of the AD7405 modulator, which is a second-order modulator. The type of filter selected, the decimation rate, and the modulator clock used determines the overall system resolution and throughput rate. The higher the decimation rate, the greater the system accuracy, as illustrated in Figure 30. However, there is a trade-off between accuracy and throughput rate and, therefore, higher decimation rates result in lower throughput solutions. Note that for a given bandwidth requirement, a higher MCLKIN frequency can allow higher decimation rates to be used, resulting in higher SNR performance.

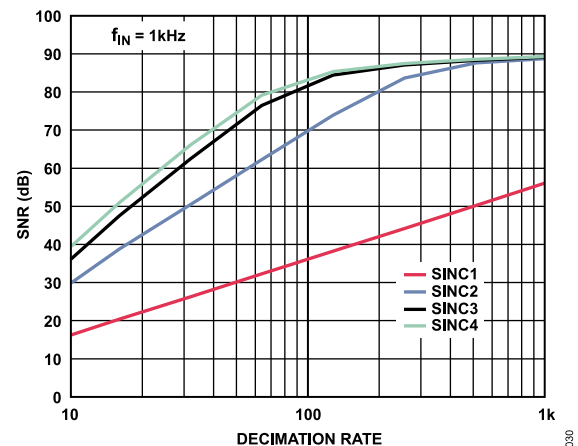

Figure 30. SNR vs. Decimation Rate for Different Sinc Filter Orders

A sinc3 filter is recommended for use with the AD7405. This filter can be implemented on a field programmable gate array (FPGA) or a digital signal processor (DSP).

Equation 7 describes the transfer function of a sinc filter.

$$H(z) = \left(\frac{1(1 - z^{-DR})}{DR(1 - z^{-1})} \right)^N \quad (7)$$

where DR is the decimation rate and N is the sinc filter order.

The throughput rate of the sinc filter is determined by the modulator clock and the decimation rate selected.

$$\text{Throughput} = \frac{MCLK}{DR} \quad (8)$$

where $MCLK$ is the modulator clock frequency

As the decimation rate increases, the data output size from the sinc filter increases. The output data size is expressed in Equation 9. The 16 most significant bits are used to return a 16-bit result.

$$\text{Data size} = N \times \log_2 DR \quad (9)$$

For a sinc3 filter, the -3 dB filter response point can be derived from the filter transfer function, Equation 7, and is 0.262 times the throughput rate. The filter characteristics for a third-order sinc3 filter are summarized in Table 11.

APPLICATIONS INFORMATION

Table 11. Sinc3 Filter Characteristics for 20 MHz MCLKIN

Decimation Ratio (DR)	Throughput Rate (kHz)	Output Data Size (Bits)	Filter Response (kHz)
32	625	15	163.7
64	312.5	18	81.8
128	156.2	21	40.9
256	78.1	24	20.4
512	39.1	27	10.2

The following Verilog code provides an example of a sinc3 filter implementation on a Xilinx® Spartan®-6 FPGA. Note that the data is read on the positive clock edge. It is recommended to read in the data on the positive clock edge. The code is configurable to accommodate decimation rates from 32 to 4096.

```

module dec256sinc24b
(
  input mclk1, /* used to clk filter */
  input reset, /* used to reset filter */
  input mdata1, /* input data to be filtered */
  output reg [15:0] DATA, /* filtered output */
  output reg data_en,
  input [15:0] dec_rate
);

/* Data is read on positive clk edge */

reg [36:0] ip_data1;
reg [36:0] acc1;
reg [36:0] acc2;
reg [36:0] acc3;
reg [36:0] acc3_d2;
reg [36:0] diff1;
reg [36:0] diff2;
reg [36:0] diff3;
reg [36:0] diff1_d;
reg [36:0] diff2_d;

reg [15:0] word_count;

reg word_clk;
reg enable;

/*Perform the Sinc action*/
always @ (mdata1)
if(mdata1==0)
  ip_data1 <= 37'd0;
  /* change 0 to a -1 for twos complement */
else
  ip_data1 <= 37'd1;
/*Accumulator (Integrator)
Perform the accumulation (IIR) at the speed of
the modulator.
Z = one sample delay MCLKOUT = modulators con▶

```

```

version bit rate */

```

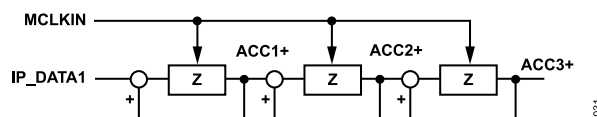

Figure 31. Accumulator

```

always @ (negedge mclk1, posedge reset)
begin
  if (reset)
  begin
    /* initialize acc registers on reset */
    acc1 <= 37'd0;
    acc2 <= 37'd0;
    acc3 <= 37'd0;
  end
  else
  begin
    /*perform accumulation process */
    acc1 <= acc1 + ip_data1;
    acc2 <= acc2 + acc1;
    acc3 <= acc3 + acc2;
  end
end

/*decimation stage (MCLKOUT/WORD_CLK) */
always @ (posedge mclk1, posedge reset)
begin
  if (reset)
    word_count <= 16'd0;
  else
  begin
    if ( word_count == dec_rate - 1 )
      word_count <= 16'd0;
    else
      word_count <= word_count
+ 16'b1;
  end
end

always @ ( posedge mclk1, posedge reset )
begin
  if ( reset )
    word_clk <= 1'b0;
  else
  begin
    if ( word_count == dec_rate/2 -
1 )
      word_clk <= 1'b1;
    else if ( word_count == dec_rate
- 1 )
      word_clk <= 1'b0;
  end
end

```

APPLICATIONS INFORMATION

```

end

/*Differentiator (including decimation stage)
Perform the differentiation stage (FIR) at a
lower speed.
Z = one sample delay WORD_CLK = output word
rate */

```

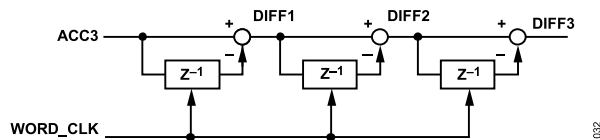

Figure 32. Differentiator

```

always @ (posedge word_clk, posedge reset)
begin
    if(reset)
    begin
        acc3_d2 <= 37'd0;
        diff1_d <= 37'd0;
        diff2_d <= 37'd0;
        diff1 <= 37'd0;
        diff2 <= 37'd0;
        diff3 <= 37'd0;
    end
    else
    begin

        diff1 <= acc3 - acc3_d2;
        diff2 <= diff1 - diff1_d;
        diff3 <= diff2 - diff2_d;
        acc3_d2 <= acc3;
        diff1_d <= diff1;
        diff2_d <= diff2;

    end

end

end

/* Clock the Sinc output into an output register
WORD_CLK = output word rate */

```

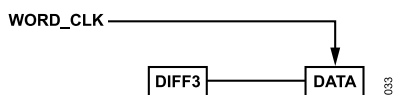

Figure 33. Clocking Sinc3 Output into an Output Register

```

always @ ( posedge word_clk )
begin

```

```

    case ( dec_rate )
        16'd32:begin
            DATA <= (diff3[15:0] ==
16'h8000) ? 16'hFFFF : {diff3[14:0], 1'b0};
            end
        16'd64:begin
            DATA <= (diff3[18:2] ==
17'h10000) ? 16'hFFFF : diff3[17:2];
            end
        16'd128:begin
            DATA <= (diff3[21:5] ==
17'h10000) ? 16'hFFFF : diff3[20:5];
            end
        16'd256:begin
            DATA <= (diff3[24:8] ==
17'h10000) ? 16'hFFFF : diff3[23:8];
            end
        16'd512:begin
            DATA <= (diff3[27:11] ==
17'h10000) ? 16'hFFFF : diff3[26:11];
            end
        16'd1024:begin
            DATA <= (diff3[30:14] ==
17'h10000) ? 16'hFFFF : diff3[29:14];
            end
        16'd2048:begin
            DATA <= (diff3[33:17] ==
17'h10000) ? 16'hFFFF : diff3[32:17];
            end
        16'd4096:begin
            DATA <= (diff3[36:20] ==
17'h10000) ? 16'hFFFF : diff3[35:20];
            end
        default:begin
            DATA <= (diff3[24:8] ==
17'h10000) ? 16'hFFFF : diff3[23:8];
            end
    endcase

```

```

end

```

```

/* Synchronize Data Output*/
always@ ( posedge mclk1, posedge reset )
begin
    if ( reset )
    begin
        data_en <= 1'b0;
        enable <= 1'b1;
    end
    else
    begin
        if ( (word_count == dec_rate/2 -
1) && enable )
        begin
            data_en <= 1'b1;
            enable <= 1'b0;
        end
    end
end

```

APPLICATIONS INFORMATION

```

        end
        else if ( (word_count ==
dec_rate - 1) && ~enable )
            begin
                data_en <= 1'b0;
                enable <= 1'b1;
            end
        else
            data_en <= 1'b0;
        end
    end
end
endmodule

```

GROUNDING AND LAYOUT

It is recommended to decouple the V_{DD1} supply with a 10 μF capacitor in parallel with a 1 nF capacitor to GND_1 . Decouple Pin 1 and Pin 7 individually. Decouple the V_{DD2} supply with a 100 nF value to GND_2 . In applications involving high common-mode transients, minimize board coupling across the isolation barrier. Furthermore, design the board layout so that any coupling that occurs equally affects all pins on a given component side. Failure to ensure equal coupling can cause voltage differentials between pins to exceed the absolute maximum ratings of the device, thereby leading to latch-up or permanent damage. Place any decoupling used as close to the supply pins as possible.

Minimize series resistance in the analog inputs to avoid any distortion effects, especially at high temperatures. If possible, equalize the source impedance on each analog input to minimize offset. To reduce offset drift, check for mismatch and thermocouple effects on the analog input printed circuit board (PCB) tracks.

INSULATION LIFETIME

All insulation structures eventually break down when subjected to voltage stress over a sufficiently long period. The rate of insulation degradation is dependent on the characteristics of the voltage waveform applied across the insulation. In addition to the testing performed by the regulatory agencies, Analog Devices carries out an extensive set of evaluations to determine the lifetime of the insulation structure within the AD7405.

Analog Devices performs accelerated life testing using voltage levels higher than the rated continuous working voltage. Acceleration factors for several operating conditions are determined. These factors allow calculation of the time to failure at the actual working voltage. The values shown in [Table 1](#) summarize the peak voltage for 20 years of service life for a bipolar, ac operating condition and the maximum VDE approved working voltages.

These tests subjected the AD7405 to continuous cross isolation voltages. To accelerate the occurrence of failures, the selected test voltages were values exceeding those of normal use. The time to failure values of these units were recorded and used to calculate the acceleration factors. These factors were then used to calculate the time to failure under the normal operating conditions. The values shown in [Table 1](#) are the lesser of the following two values:

- ▶ The value that ensures at least a 20-year lifetime of continuous use.
- ▶ The maximum VDE approved working voltage.

Note that the lifetime of the AD7405 varies according to the waveform type imposed across the isolation barrier. The *iCoupler* insulation structure is stressed differently, depending on whether the waveform is bipolar ac, unipolar ac, or dc. [Figure 34](#), [Figure 35](#), and [Figure 36](#) illustrate the different isolation voltage waveforms.

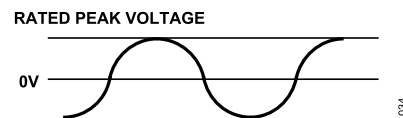

Figure 34. Bipolar AC Waveform, 50 Hz or 60 Hz

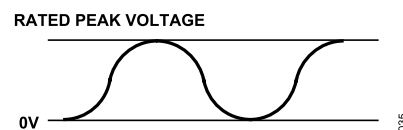

Figure 35. Unipolar AC Waveform, 50 Hz or 60 Hz

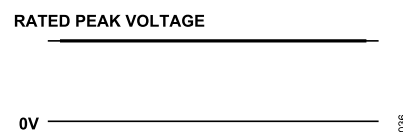

Figure 36. DC Waveform

OUTLINE DIMENSIONS

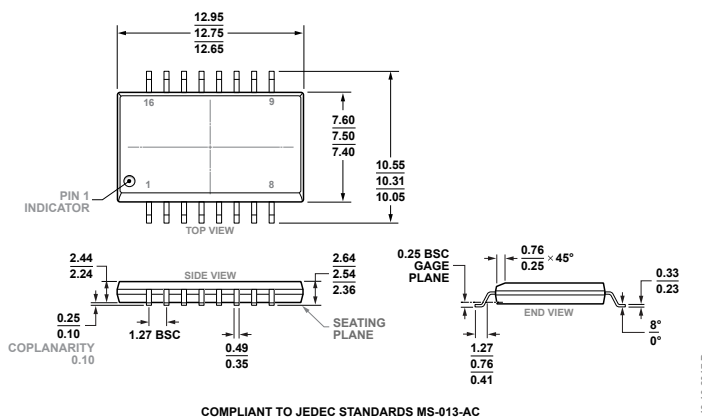

Figure 37. 16-Lead Standard Small Outline Package, with Increased Creepage [SOIC_IC] Wide Body (RI-16-2) Dimensions shown in millimeters

Updated: January 10, 2024

ORDERING GUIDE

Model ¹	Temperature Range	Package Description	Packing Quantity	Package Option
AD7405BRIZ	-40°C to +125°C	16-Lead SOIC (Increased Creepage)		RI-16-2
AD7405BRIZ-RL	-40°C to +125°C	16-Lead SOIC (Increased Creepage)	Reel, 1000	RI-16-2
AD7405BRIZ-RL7	-40°C to +125°C	16-Lead SOIC (Increased Creepage)	Reel, 400	RI-16-2

¹ Z = RoHS Compliant Part.

EVALUATION BOARDS

Model ¹	Description
EVAL-AD7405FMCZ	Evaluation Board

¹ Z = RoHS Compliant Part.

Looking for pricing, stock, or lifecycle information?

Click below to explore more details on WIN SOURCE:

 View [AD7405BRIZ](#) on WIN SOURCE

 [Analog Devices Inc.](#) Information

Optimize Your Supply Chain with WIN SOURCE Solutions

-  Global Sourcing Solution
-  Obsolete Management
-  Cost Control Management
-  Shortage Management
-  Alternative Solution
-  Excess Inventory Management