



THE DATASHEET OF AC1010



AC Series • Current Transformer Quick Reference Guide

Low Cost 50/60Hz Current Transformers

Applications

- Sensing Overload Current
- Ground fault detection
- Metering
- Analog to Digital Circuits

Features

- Excellent quality at extremely competitive price due to high volume production
- Manufactured in an ISO 9001:2015 and ISO 14001:2015 certified Talema facility
- Fully RoHS & REACH Compliant



Schematic

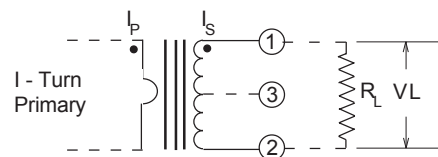

Electrical Specifications at 20°C

AC Series • Standard Accuracy Current Transformers																			
Part No.	Primary Current I_p Amps	Turns Ratio	Terminating Resistor R_L		DCR (Ohms)	RCF @ 10%	Volts/Amp @ rated I_p for various loads (Ohms)				μ Arms	Vrms	Net Weight (grams)	Case Dimensions - mm					
			Ohms	Watt			Nominal	100	500	2K				5K	L	ID	H	W	C
AC1005	5	1000:1	100	0.0025	41.80	1.010	0.10	0.46	1.43	2.01	237	0.66	16.3	--	--	--	--	--	--
AC1010	10	1000:1	100	0.0100	41.80	1.010	0.10	0.45	1.10	1.42	386	1.32	16.3	--	--	--	--	--	--
AC1015	15	1000:1	100	0.0230	41.80	1.010	0.10	0.45	0.90	1.12	513	1.99	16.3	--	--	--	--	--	--
AC1020	20	1000:1	100	0.0400	41.80	1.010	0.10	0.43	0.76	0.93	628	2.65	16.3	--	--	--	--	--	--
AC1025	25	1000:1	100	0.0630	48.00	1.020	0.10	0.47	1.06	1.31	566	3.65	35.5	30.20	11.40	30.20	14.30	20.32	10.16
AC1030	30	1000:1	100	0.0900	48.00	1.020	0.10	0.47	0.95	1.16	644	4.38	35.5	30.20	11.40	30.20	14.30	20.32	10.16
AC1040	40	1000:1	100	0.1600	49.30	1.026	0.10	0.46	0.87	1.05	914	5.82	47.3	34.90	14.60	34.90	14.30	25.40	10.16
AC1050	50	1000:1	100	0.2500	49.30	1.026	0.10	0.43	0.76	0.90	1090	7.28	47.3	34.90	14.60	34.90	14.30	25.40	10.16
AC1060	60	1000:1	100	0.3600	24.00	1.001	0.10	0.44	0.66	0.76	1250	7.41	65.2	38.10	14.60	38.10	15.90	33.00	10.16
AC1075	75	1000:1	100	0.5700	24.00	1.001	0.10	0.39	0.57	0.65	1520	9.26	65.2	38.10	14.60	38.10	15.90	33.00	10.16
AC1100	100	1000:1	100	1.0000	21.30	1.001	0.10	0.34	0.50	0.56	1740	12.00	80.0	44.50	19.05	44.50	14.30	35.56	10.16
AC1150	150	1000:1	100	2.2500	11.00	1.002	0.10	0.37	0.50	0.55	1820	16.60	150.0	55.60	23.80	55.60	20.60	45.72	12.70
AC1200	200	1000:1	100	4.0000	11.00	1.002	0.10	0.31	0.41	0.45	2340	22.20	150.0	55.60	23.80	55.60	20.60	45.72	12.70

RCF : Ratio correction factor - Multiply current readings by this factor to compensate for transformer losses

Mechanical Drawing

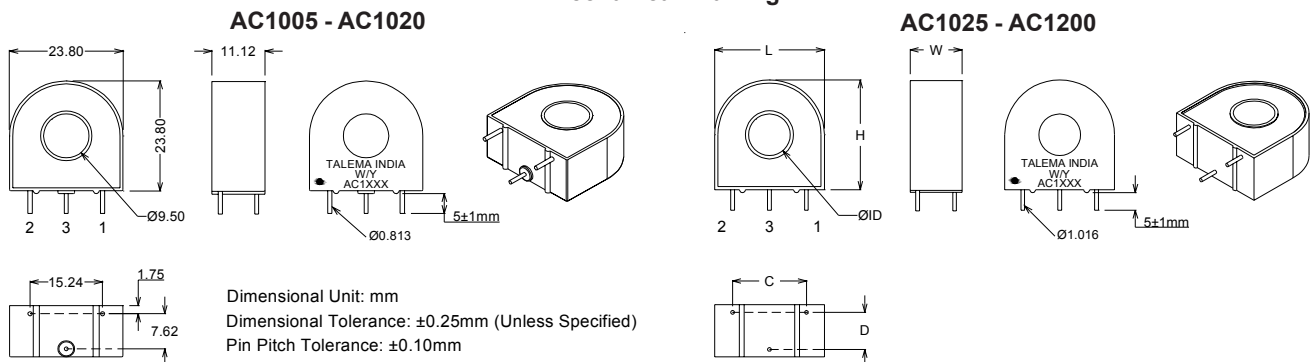

Notes:

- 1) Unless requested, the terminating resistor and the one-turn primary are not supplied
- 2) Pin 3: Normally for mechanical support only but will be used on center tapped designs
- 3) Each part number adjusted to be most accurate at specified load

Dimensional Unit: mm
Dimensional Tolerance: ± 0.25 mm (Unless Specified)
Pin Pitch Tolerance: ± 0.10 mm

Regional Locations - Design, Manufacturing, Sales & Marketing
Talema Group Regional Offices
North America
**United States
(Sales & Marketing)**

Talema Group, LLC
 PO Box 935
 900 Innovation Drive
 Suite 120, Rolla
 Missouri 65402
 Tel: +1 573-303-3675
 E-Mail:
sales@talemagroup.com
 Web: www.talema.com

Asia
**India
(Design, Manufacturing, Sales & Marketing)**

Administrative Office
Talema Electronic India Private Limited
 Door No. 221, 1st and 2nd Floor
 KJ Plaza, Opp.to Vidya Mandir School
 Meyanoor Main Road
 Salem - 636 004 Tamil Nadu INDIA
 Tel: +91 427 - 243 3100
 Fax: +91 427 - 243 3109
 E-Mail: talema@talemaindia.net
 Web: www.talema.com

Factory Premises
Talema Electronic India Private Limited
 Plot Nos. 30, 31 Electrical and Electronic
 Industrial Estate
 Suramangalam
 Salem - 636 005 Tamil Nadu INDIA
 Tel: +91 427 - 243 3000
 E-Mail: talema@talemaindia.net
 Web: www.talema.com

Europe
**Germany
(Design, Sales & Marketing)**

Talema Elektronik GmbH
 Sembdnerstr. 5
 82110 Germering
 Tel: +49 89 - 841 00 - 0
 Fax: +49 89 - 841 00 25
 E-Mail: info@talema.de
 Web: www.talema.com

**Ireland
(Design, Sales & Marketing)**

Nuvotem TEO
 Units W & X, Gweedore Business Park
 Derrybeg, Letterkenny, Co. Donegal
 Tel: +353 (0) 74 95 48666
 Fax: +353 (0) 74 95 48139
 E-Mail: info@nuvotem.com
 Web: www.nuvotem.com

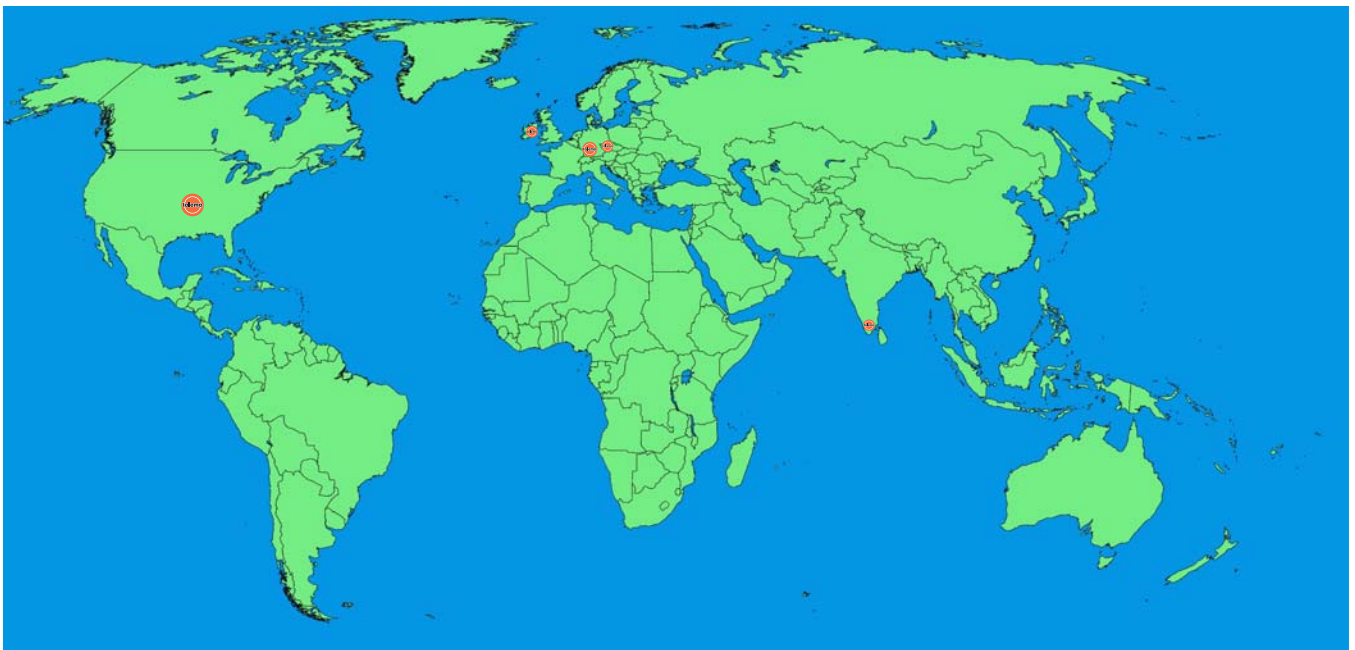

**Czech Republic
(Design, Manufacturing, Sales & Marketing)**

NT Magnetics s.r.o.
 Chebská 27
 322 00 Plzeň
 Tel: +420 377 - 338 351
 Fax: +420 377 - 338 350
 E-Mail: talema@talema.cz
 Web: www.ntmagnetics.cz

Locations of Talema Group Regional Offices

Looking for pricing, stock, or lifecycle information?

Click below to explore more details on WIN SOURCE:

-  [View AC1010 on WIN SOURCE](#)
-  [Talema Group LLC Information](#)

Optimize Your Supply Chain with WIN SOURCE Solutions

-  Global Sourcing Solution
-  Obsolete Management
-  Cost Control Management
-  Shortage Management
-  Alternative Solution
-  Excess Inventory Management