



THE DATASHEET OF A6111



Comata 2.4 GHz SMD Antenna

Product Specification

1 Features

- Designed for 2.4 GHz applications [Bluetooth™, WiFi™ (802.11b/g), Zigbee™, WiMedia™ etc.]
- Intended for SMD mounting
- Supplied in tape on reel

2 Description

The Comata antenna is intended for use with all 2.4 GHz applications. The antenna requires a groundplane, i.e. your device acts as an active part of the antenna and thus demand careful consideration concerning its placement.

3 Application

- Handheld devices
- Headsets
- Laptops
- Sensors

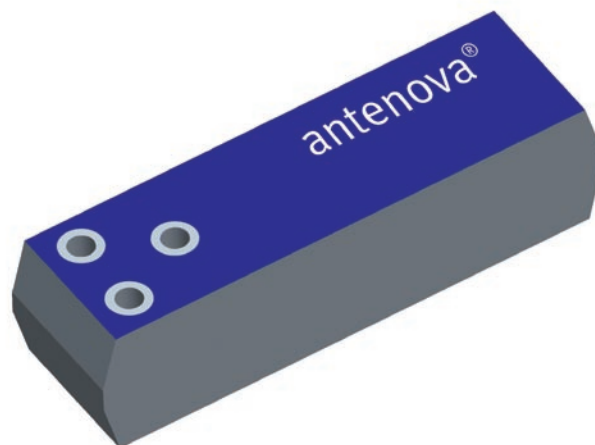

Contents

1 Features	1
2 Description	1
3 Application	1
4 Model name	3
5 General data	3
6 Electrical characteristics	3
7 Electrical performance	4
7-1 Voltage Standing Wave Ratio	4
7-2 3D-Radiation	4
7-3 Radiation patterns	4
8. Antenna Dimensions	5
9 Antenna Foot print	5
10 Electrical interface	6
10-1 Transmission line and matching	6
10-2 Test board dimensions	6
10-3 Test board matching	6
11 Soldering	7
11-1 Recommended soldering conditions	7
11-2 Leadfree soldering	7
12 Reliability	7
12-1 Temperature and Humidity	7
12-2 Mechanical	8
12-3 Miscellaneous	8
12-4 Judgement standard	8
13 Hazardous Material Regulation Conformance	8
14 Application example	9
15 Packaging	10
15-1 Shelf storage recommendation	10
15-2 Tape characteristics	10
15-3 Reel dimension	10
15-4 Box dimension	11
15-5 Bag properties	11
15-6 Reel label information	11

4 Model name

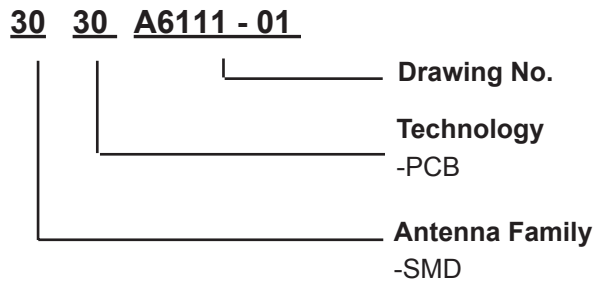

5 General data

Product Name	Comata 2.4 GHz
Article No.	3030A6111-01
Frequency	2.4-2.5 GHz
Polarization	Linear
Operating temperature	-40 to + 85 degC
Impedance	50 Ohm
Weight	0.4 gram
Antenna type	SMD

6 Electrical characteristics

	Characteristics			Conditions*
	Min	Typ	Max	
Peak Gain	dBi	dBi	dBi	Frequency 2.4-2.5 GHz, Measured in 3D chamber (near field)
Efficiency	50%	55%	60%	
VSWR	<2:1	<2:1	<2:1	Frequency 2.4-2.5 GHz, Measured in Network Analyzer

*Note all data provided in this table are based on the gigaAnt reference board

7 Electrical performance

7-1 Voltage Standing Wave Ratio

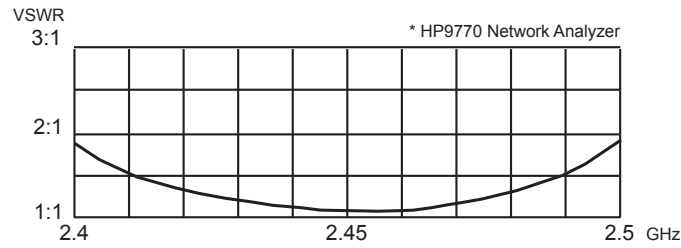

7-2 3D-Radiation

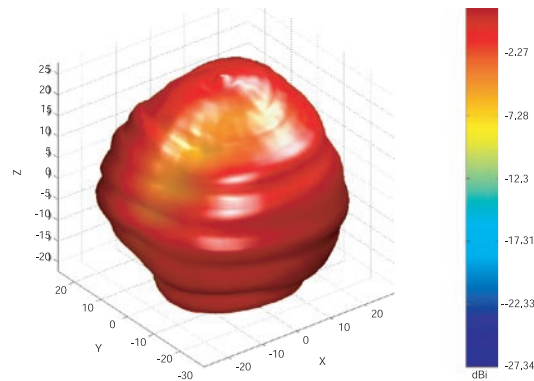

7-3 Radiation patterns

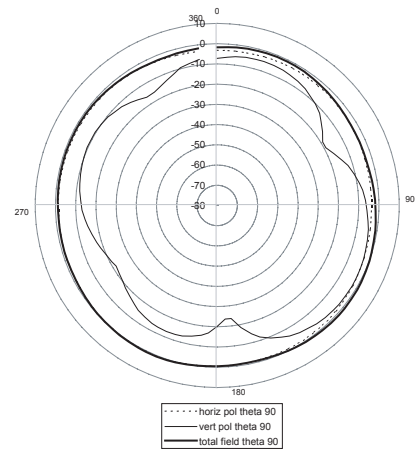
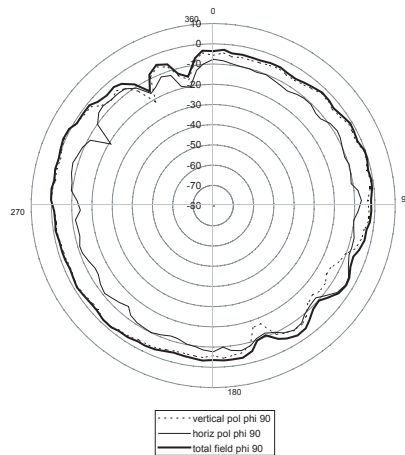
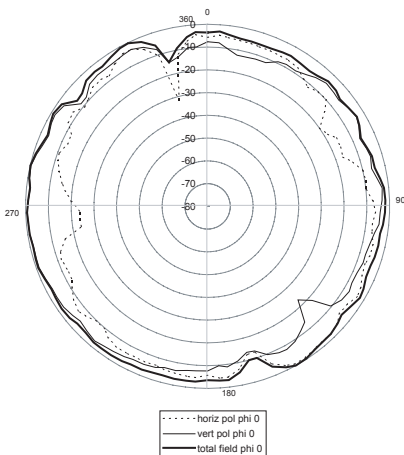
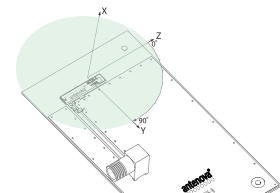
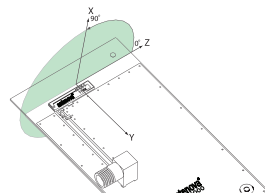
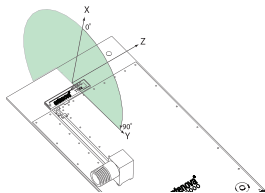

8. Antenna Dimensions

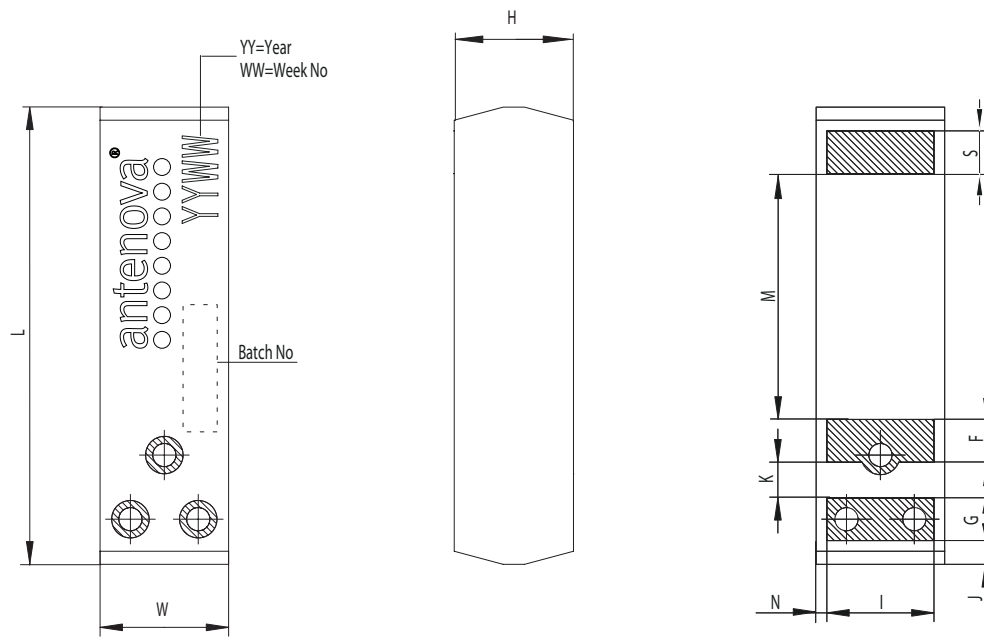

L	W	H	G	F	S	I	J	K	M	N
Length	Width	Height	Ground	Feed	Solder					
12.8 ±0.3	3.6 ±0.2	3.3±0.2	1.2±0.1	1.2±0.1	1.2±0.1	3.0±0.1	0.65±0.25	1.0±0.1	6.9±0.2	0.3±0.1

Dimensions in millimeters

9 Antenna Foot print

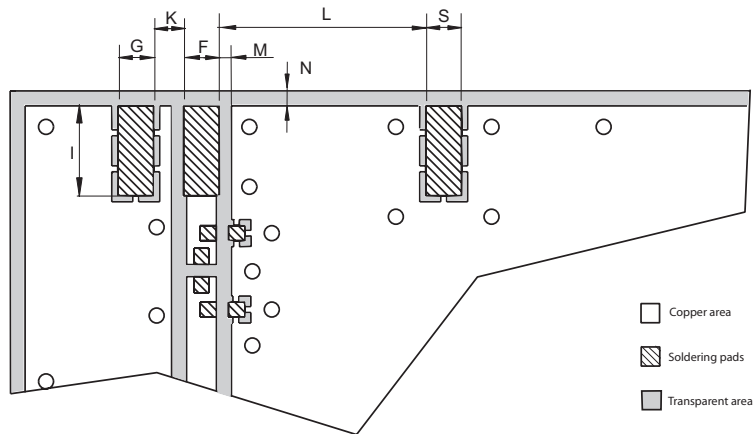

G	F	S	I	K	L	M	N
Ground	Feed	Solder					
1.2±0.1	1.2±0.1	1.2±0.1	3.0±0.1	1.0±0.1	6.9±0.2	0.4±0.1	0.5±0.1

Dimensions in millimeters

10 Electrical interface

10-1 Transmission line and matching

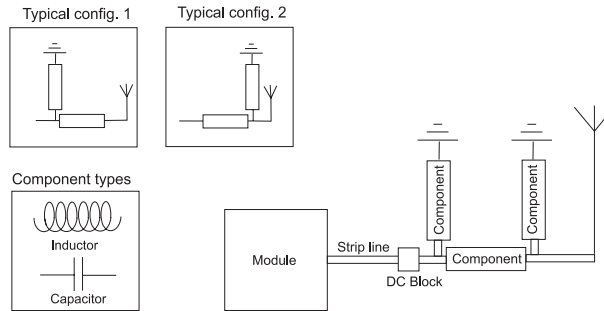

The matching network has to be individually designed using one, two or three components.

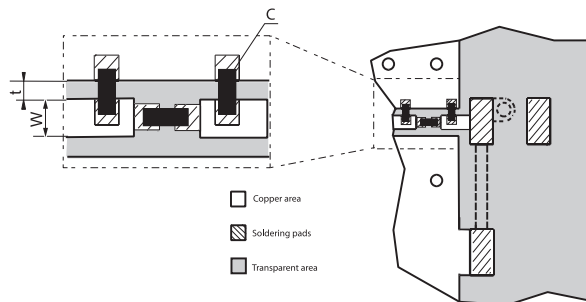

t, w = Unique dimensioning according to your PCB *

C = Inductor and capacitor values according to your specific device*

* Antenna provides this service upon request

10-2 Test board dimensions

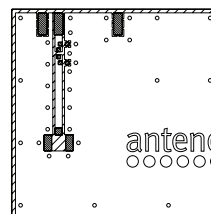

The testboard is designed for evaluation purposes for Comata 2.4 GHz SMD antenna. The board has the same size as a typical CF card and is fitted with an U.FL connector.

10-3 Test board matching

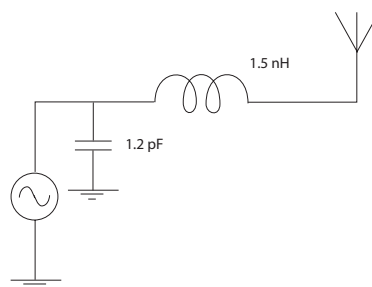

The testboard is matched with above specified component.

Note! The component value(s) will vary depending on size of PCB, surrounding components etc.

11 Soldering

11-1 Recommended soldering conditions

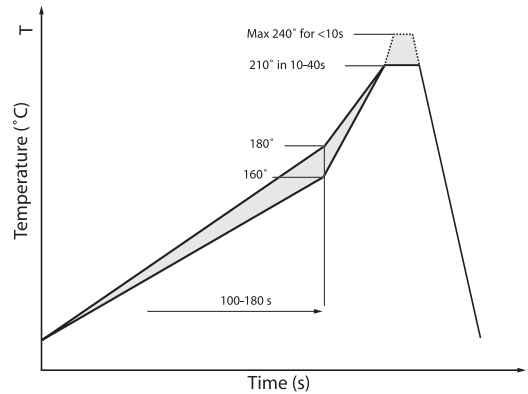

11-2 Leadfree soldering

The antenna has been tested and approved for leadfree soldering. The reflow curve and solder paste used is listed below.

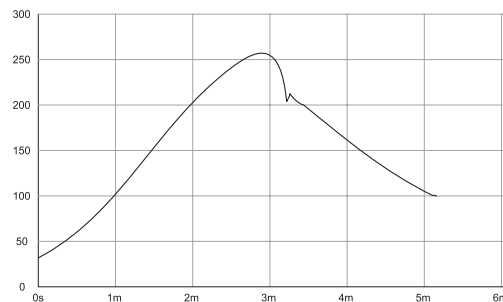

Solder paste: KOKI S3X58-M405

12 Reliability

12-1 Temperature and Humidity

Item	Standard	Low	High	Duration
Operating temperature	EN/IEC 60068-2-2, Test Bd: Dry heat	-30 degC	+90 degC	-
Temperature cycling	EN/IEC 60068-2-14, Test Na: Change of temperature	-40 degC	+90 degC	500 cycles /10 min
Storage life Humidity	EN/IEC 60068-2-1, Test Ca: Damp heat	+60 degC / 90% RH		500 h
Storage life Low temperature	EN/IEC 60068-2-1, Test Ad: Cold	-55 degC	-	500 h

12-2 Mechanical

Item	Standard	Low	High	Duration
Bending	IEC 60068-2-21, Test Ue1: Bending	Bending 1 mm at a rate of 1 mm/s with support at end of PCB 1mm depth on reference board		
Shear	IEC 60068-2-21, Test Ue3: Shear	Force of 5 N applied to the side of the antenna.		
Drop test		Dummy weight: 150g Height: 170cm		One drop at each side, total drops: 6
Vibration	EN/IEC 60068-2-6, Test Fc (sinusoidal)	Acceleration spectral density:10-1000Hz Acceleration: 20m/s ² Number of axes: 3 mutually perpendicular		5 cycles per axis

12-3 Miscellaneous

Item	Standard	Low	High	Duration
Solderability	EN/IEC 60068-2-58, Test Td	Visual inspection of soldering pads. Estimation of how many % of the pads that are well tin plated.		

12-4 Judgement standard

The judgement of the above tests should be made as follows:

1. Visual inspection - Normal appearance with no obvious cracking, peeling-off.
2. Electrical inspection - The DUT satisfies the VSWR specification throughout the 2.4-2.5 GHz band

13 Hazardous Material Regulation Conformance

Cadmium and cadmium compound.
Organic brominated compound (PBB, PBDE)
Polychlorinated biphenyl (PCB)
Polychlorinated naphthalene (PCN)
Organic tin compound
Asbestos
Azo compound

Lead and lead compound
Mercury and mercury compound
Sexivalent chrome compound
Chlorinated paraffin (CP)
Mirex
Formaldehyde
Tetra-bromo-bisphenol-A-bis (TBBP-A-bis)

14 Application example

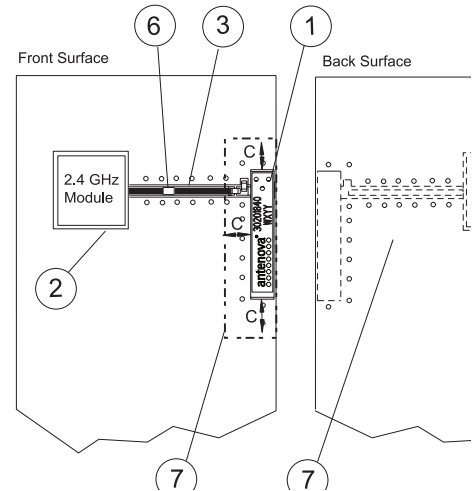
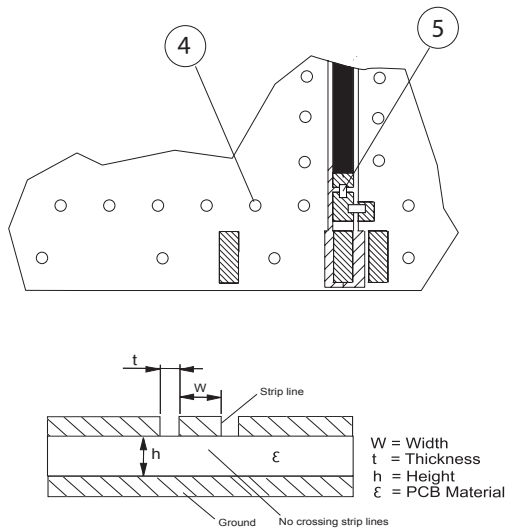

The antenna is of a quarter wave type and is dependent on the groundplane area to complete the antenna function. The antenna performance is also dependent on the size of the groundplane.

1. Placement of the antenna

The antenna shall be placed on a groundplane area, preferably at the edge of the PCB oriented as above.

2. Placement of 2.4 GHz module

To avoid losses in the strip line, the module shall be placed as close to the antenna as possible.

3. Strip line

The strip line must be dimensioned according to your specific PCB. (see fig 1). No crossing strip lines are allowed between the strip line and its ground plane.

4. Via connections

To avoid spurious effects, via connections must be made to analogue ground.

5. Component matching

Component values are depending on antenna placement, PCB dimensions and location of other components.

6. DC Block

Might be needed depending on RF Module configuration.

7. Clearance

Front surface: Minimum clearance to other components, C = 2-5 mm. Back surface: Components allowed.

8. Casing material

No metal casing or plastics using metal flakes shall be used, avoid also metallic based paint or laquer.

**Note ! Incorrect implementation of the antenna will affect the performance.
Contact Antenna for implementation services**

15 Packaging

15-1 Shelf storage recommendation

Temperature	-10 to +40 degree C
Humidity	Less than 75% RH
Shelf Life	18 Months
Storage place	Away from corrosive gas and direct sunlight

15-2 Tape characteristics

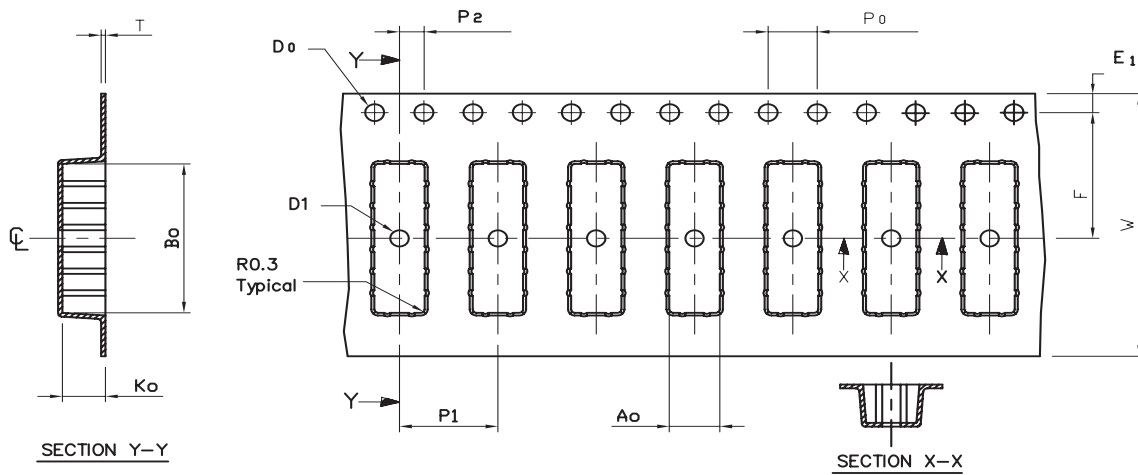

W	F	E ₁	P ₀	P ₁	P ₂	A ₀	B ₀	K ₀	T	D ₀	D ₁
24±0.3	11.50±0.1	1.75±0.1	4.0±0.1	8.0±0.1	2.0±0.1	4.1±0.1	13.6±0.1	3.50±0.1	0.35±0.05	1.55±0.05	1.5 Min

Dimensions in millimeter

Quantity	Leading space	Trailing space
2000 Pcs / reel	50 blank antenna holders	37 blank antenna holders

15-3 Reel dimension

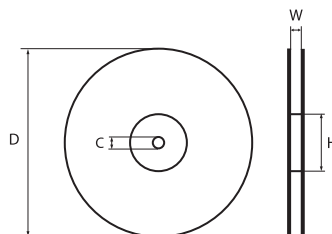

Material: Conductive Polystyrene
 Width [mm] W: 32
 Reel dia [mm] D: 330(13")
 Hub dia [mm] H: 100(4")
 Shaft dia [mm] C: 13

15-4 Box dimension

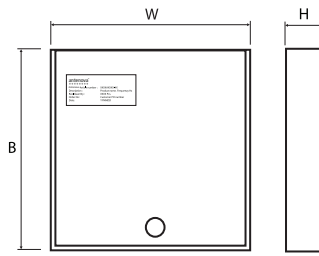

Material: Cardboard
 Width [mm] W: 345
 Breadth [mm] B: 345
 Thickness [mm] H: 45

15-5 Bag properties

Antistatic Aluminium Moisture Barrier Bag

Thickness [mil] T: 3.2

15-6 Reel label information

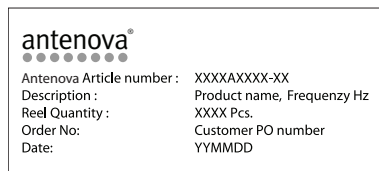



www.antenova.com

Corporate Headquarters

Antenova Ltd.

Far Field House
Albert Road
Stow-cum-Quy
Cambridge
CB9 5AR

Tel: +44 (0) 1223 810600
Fax: +44 (0) 1223 810650
Email: info@antenova.com

Asia Headquarters

Antenova Asia Ltd.

3F, No 10, Alley 6, Lane 45
Poa Shing Road
Hsin Tien City
Taipe County
ROC 23145

Tel: +886 (0) 2 2917 6536
Fax: +886 (0) 2 2910 6546
Email: info@antenova.com

Sales Offices

Europe

Charlotta Olander

UK/EU Sales Manager

Tel: +46 702 913731
Email: Lotta.Olander@antenova.com

America

David Nuti

NA Sales Manager

Tel: +1 214 668 0357
Email: David.Nuti@antenova.com

Asia

CL Lim

VP Sales Asia

Tel: +886 (0) 931 201 318
Email: CL.Lim@antenova.com



Certificate No: 4598/04

Integrated Antenna Solutions

Looking for pricing, stock, or lifecycle information?

Click below to explore more details on WIN SOURCE:

- [View A6111 on WIN SOURCE](#)
- [Antenova Information](#)

Optimize Your Supply Chain with WIN SOURCE Solutions

- ✓ Global Sourcing Solution
- ✓ Obsolete Management
- ✓ Cost Control Management
- ✓ Shortage Management
- ✓ Alternative Solution
- ✓ Excess Inventory Management