

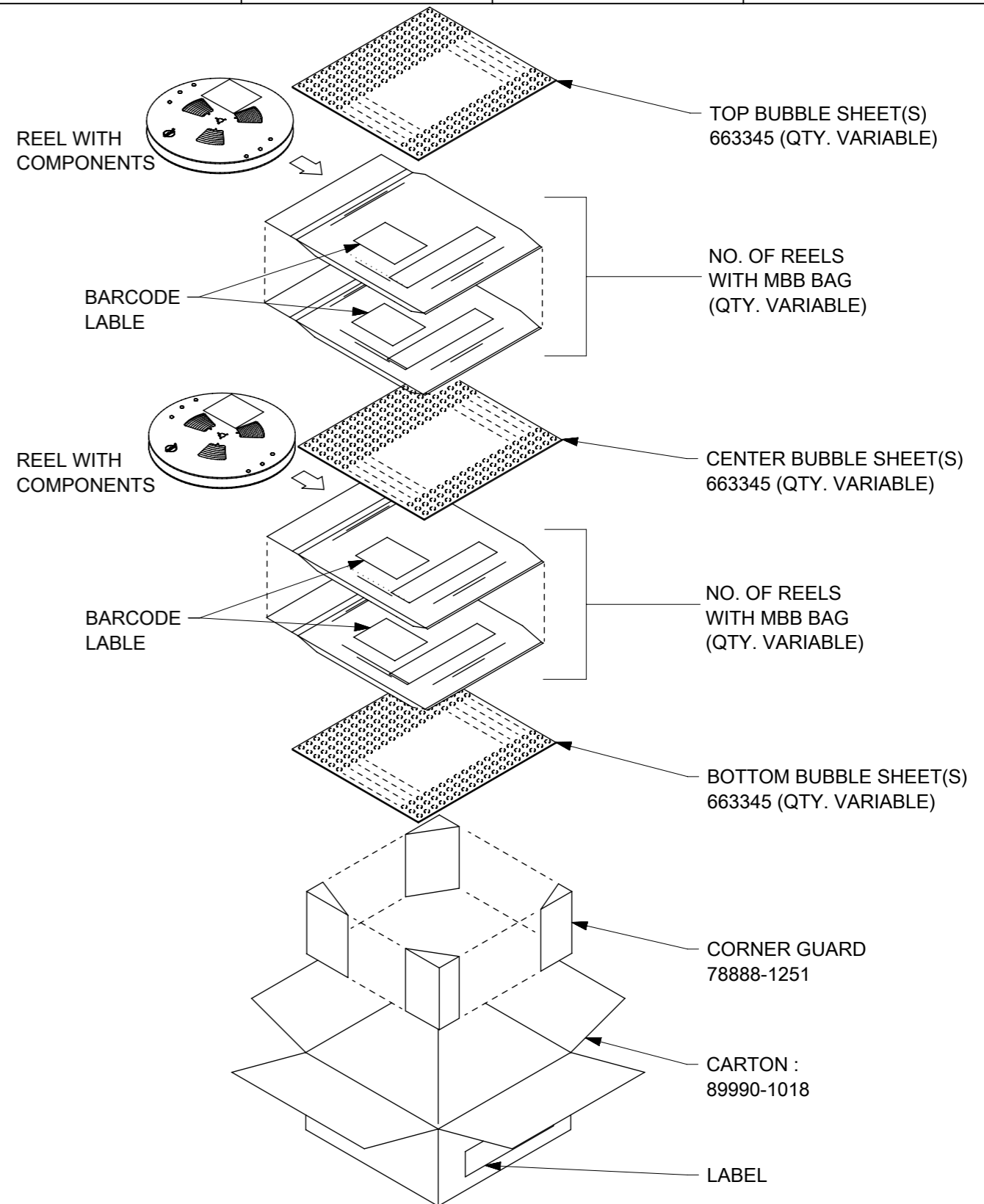

**THE DATASHEET OF**  
**0878321042**

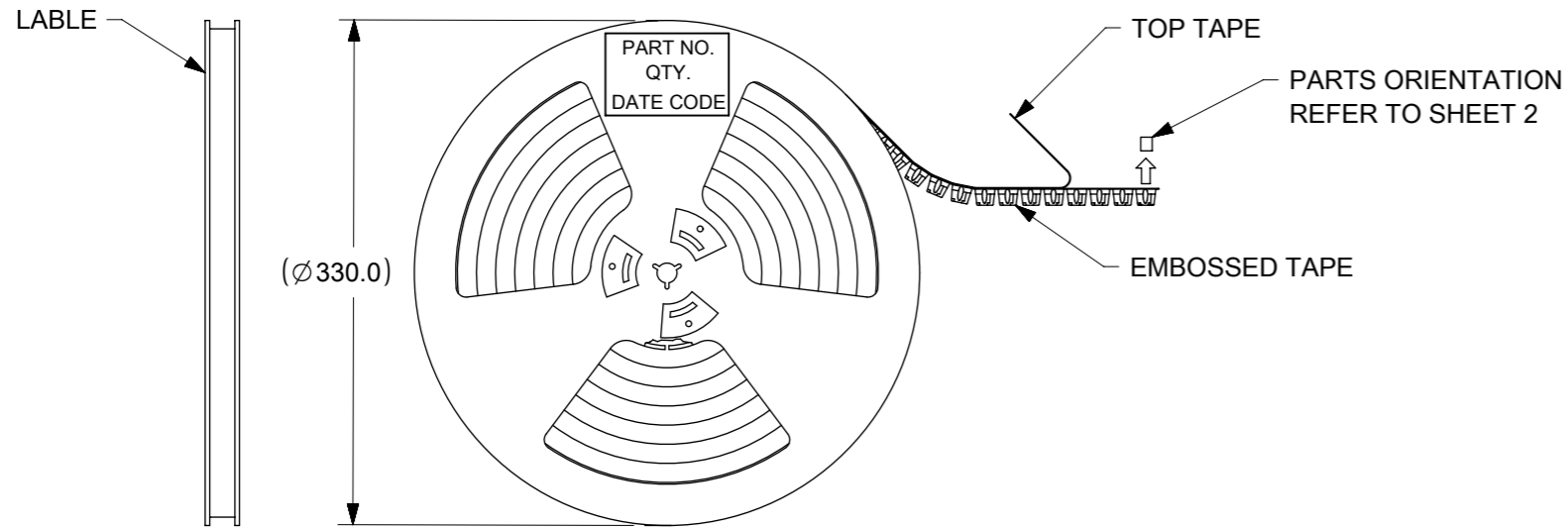



**NOTES:**

1. ALL REQUIREMENTS FOR TAPING SURFACE MOUNT COMPONENTS IS AS PER EIA-481 STANDARD.
3. THE TOP COVER TAPE SHALL BE CLEAR ONLY, AND SHALL NOT EXTEND OVER THE EDGES OF THE CARRIER TAPE OR COVER ANY PART OF THE SPROCKET HOLES.
4. THE TOP COVER TAPE MUST BE SECURELY ATTACHED TO THE EMBOSSSED CARRIER TAPE BY USE OF HEAT.
5. EACH REEL SHALL HAVE A LABEL AFFIXED TO IT WITH THE FOLLOWING INFORMATION:  
PART NO., QUANTITY, DATE CODE
6. EACH REEL MUST BE PACKED IN AN MBB BAG.
7. TAPE SPLICES ARE NOT PERMITTED.

THIS DRAWING CONTAINS INFORMATION THAT IS PROPRIETARY TO MOLEX ELECTRONIC TECHNOLOGIES, LLC AND SHOULD NOT BE USED WITHOUT WRITTEN PERMISSION														
<b>QUALITY SYMBOLS</b> ▽A = 0 ▽E = 0 ▽D = 0 ▼ = 0 ▽C = 0 ⊠ = 0 ■ = 0 ▽ = 0	<b>RE-MASTERED IN ELECTR</b> EC NO: 119993 DRWN: MUM CHK'D: GMENARLY REV APPR: KHLIM	2017/06/27 2017/08/10 2017/08/10	GENERAL TOLERANCES (UNLESS SPECIFIED)		DIMENSION UNITS		SCALE							
			MM	INCH	MM	NTS	DRWN BY	DATE						
			4 PLACES ±	±	ATSEE	2015/08/24	CHK'D BY	DATE	<b>PACKAGING SPECIFICATION FOR 87832 IN T&amp;R</b>					
			3 PLACES ±	±	CGOH	2015/08/24	APPR BY	DATE						
			2 PLACES ±	±	KHLIM	2017/05/26	<b>PACKAGING DESIGN DRAWING</b>							
			1 PLACES ±	±	DRAWING SIZE: A3					THIRD ANGLE PROJECTION		SERIES: 87832	MATERIAL NUMBER: SEE TABLE	CUSTOMER: GENERAL MARKET
			0 PLACES ±	±	ANGULAR TOL = 1.0		DRAFT WHERE APPLICABLE MUST REMAIN WITHIN DIMENSIONS		DOCUMENT NUMBER: PK-87832-300			DOC TYPE: PDD	DOC PART: 001	SHEET NUMBER: 1 OF 12

# TAPE AND REEL PACKAGING SPECIFICATIONS

## EMBOSSED TAPE WIDTH FROM 16.00mm TO 24.00mm

8 CKT USE FOR ILLUSTRATION ONLY.

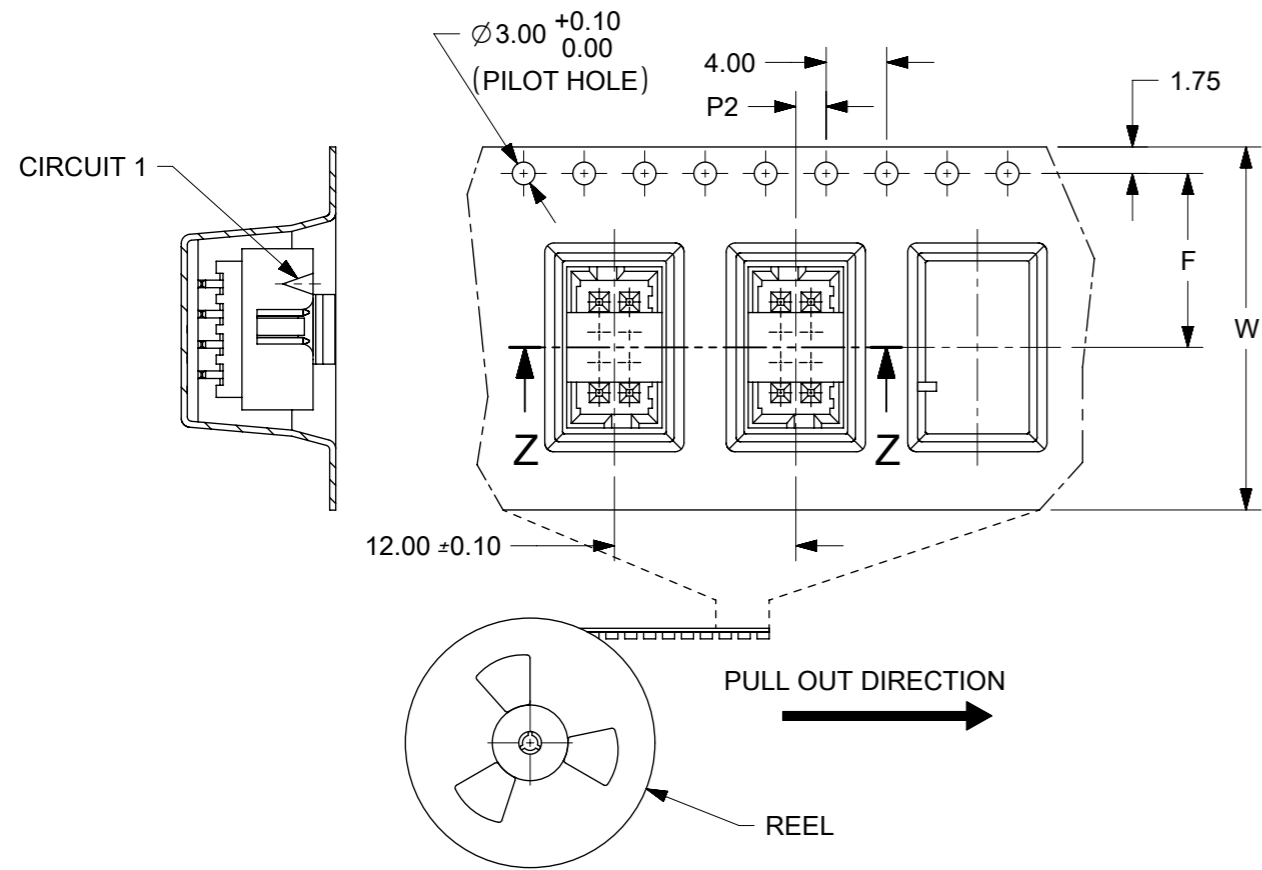

## EMBOSSED TAPE WIDTH FROM 44.00mm TO 72.00mm

24 CKT USE FOR ILLUSTRATION ONLY.

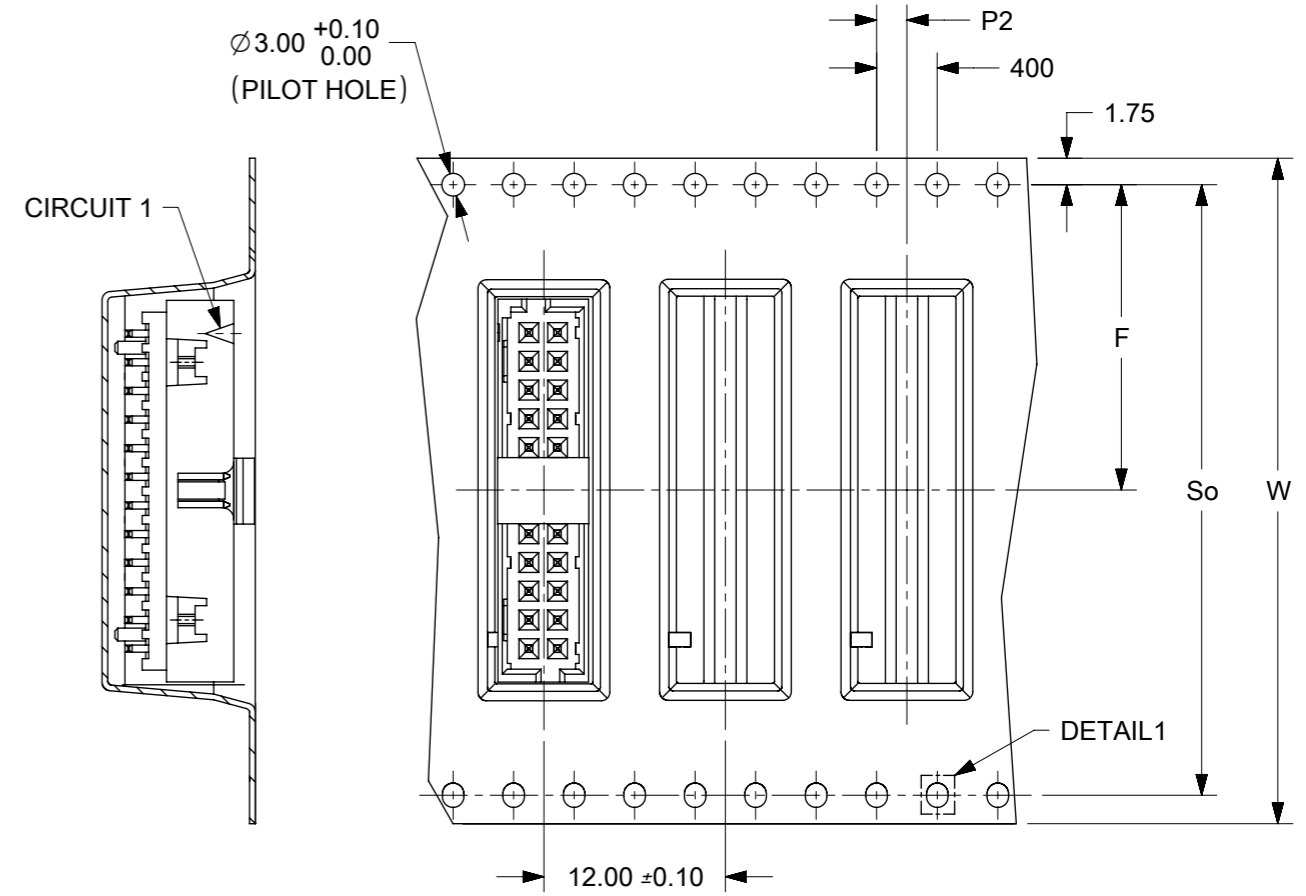

### NOTES:

1. LEADER AND TRAILER TAPE

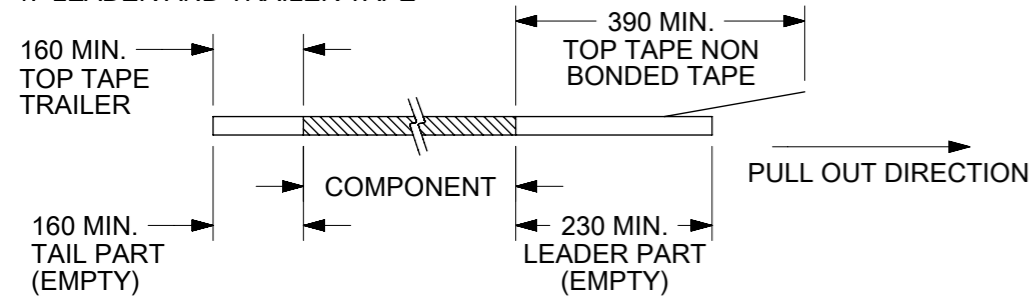

2. PEELING OFF FORCE OF THE TOP TAPE: 10 - 130gf.

(PEELING DIRECTION AS SHOWN IN FOLLOWING FIGURE)

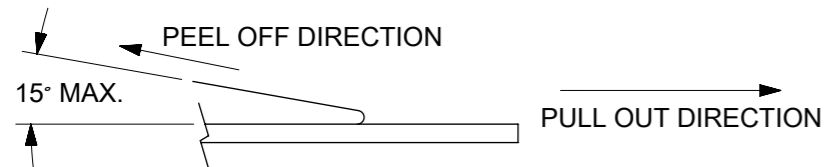

3. TAPE AND REEL SPECIFICATION IS AS PER EIA-481.

4. TAPE AND REEL QUANTITY : SEE TABLE

5. THE TAPE IS TREATED FOR ANTI-STATIC.

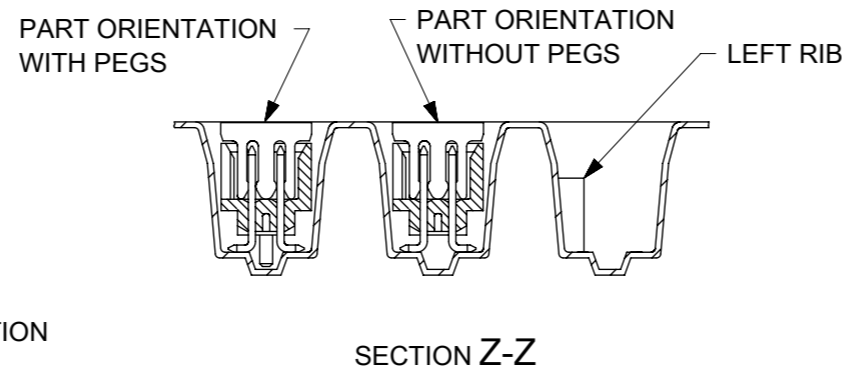

W	F	So	P2
16	7.50±0.10	-	2.00±0.10
24	11.50±0.10	-	2.00±0.10
32	14.20±0.10	28.40±0.10	2.00±0.10
44	20.20±0.15	40.40±0.10	2.00±0.15
56	26.20±0.15	52.40±0.10	2.00±0.15
72	34.20±0.30	68.40±0.10	2.00±0.20

THIS DRAWING CONTAINS INFORMATION THAT IS PROPRIETARY TO MOLEX ELECTRONIC TECHNOLOGIES, LLC AND SHOULD NOT BE USED WITHOUT WRITTEN PERMISSION											
QUALITY SYMBOLS	RE-MASTERED IN ELECTR	EC NO: 119993	DRWN: MUM	CHKD: GMENARLY	REV APPR: KHLIM	GENERAL TOLERANCES (UNLESS SPECIFIED)		DIMENSION UNITS	SCALE		
						MM	INCH	MM	NTS		
▽A = 0	2017/06/27					4 PLACES ± ±	DRWN BY	DATE	PACKAGING SPECIFICATION FOR 87832 IN T&R PACKAGING DESIGN DRAWING		
▽E = 0	2017/08/10					3 PLACES ± ±	ATSEE	2015/08/24			
▽B = 0						2 PLACES ± ±	CHK'D BY	DATE	PACKAGING DESIGN DRAWING		
▼ = 0						1 PLACES ± ±	CGOH	2015/08/24			
▽C = 0						0 PLACES ± ±	APPR BY	DATE	SERIES: 87832 MATERIAL NUMBER: SEE TABLE CUSTOMER: GENERAL MARKET		
⊠ = 0						ANGULAR TOL = 1.0	KHLIM	2017/05/26			
■ = 0						DRAFT WHERE APPLICABLE MUST REMAIN WITHIN DIMENSIONS	DRAWING SIZE	THIRD ANGLE PROJECTION	DOCUMENT NUMBER: PK-87832-300 DOC TYPE: PDD DOC PART: 001 SHEET NUMBER: 2 OF 12		
▽ = 0							A3				

CKTS	PART NUMBER	EMBOSSSED TAPE	REEL	TOP TAPE	OPTION (SEE SHEET 12)	EMBOSS WIDTH	QTY./REEL	REELS/CARTON	BUBBLE SHEETS QTY.			CORNER GUIDES 78888-1251	
									TOP	CENTER	BOTTOM		
4	87832-0406	89990-0145	89990-5709	89990-5602	1	16	500	7	-	-	-	-	
	87832-0407	89990-0145	89990-5709	89990-5602	1	16	500	7	-	-	-	-	
	87832-5122	89990-7601	89990-5709	89990-5602	1	16	500	7	-	-	-	-	
	87832-5123	89990-7601	89990-5709	89990-5602	1	16	500	7	-	-	-	-	
	87832-5162	89990-7601	89990-5709	89990-5602	1	16	500	7	-	-	-	-	
	87832-5172	89990-7601	89990-5709	89990-5602	1	16	500	7	-	-	-	-	
	87832-5106	151000-4241	89990-5710	89990-5603	2	24	500	5	-	-	-	-	
6	87832-0606	89990-7752	89990-5710	89990-5603	1	24	500	5	-	-	-	-	
	87832-0607	89990-7752	89990-5710	89990-5603	1	24	500	5	-	-	-	-	
	87832-0614	89990-7602	89990-5710	89990-5603	1	24	500	5	-	-	-	-	
	87832-0615	89990-7602	89990-5710	89990-5603	1	24	500	5	-	-	-	-	
	87832-0628	89990-7752	89990-5710	89990-5603	1	24	500	5	-	-	-	-	
	87832-0629	89990-7752	89990-5710	89990-5603	1	24	500	5	-	-	-	-	
	87832-0642	89990-7752	89990-5710	89990-5603	1	24	500	4	-	-	-	-	
	87832-5222	89990-7602	89990-5710	89990-5603	1	24	500	5	-	-	-	-	
	87832-5223	89990-7602	89990-5710	89990-5603	1	24	500	5	-	-	-	-	
	87832-5262	89990-7602	89990-5710	89990-5603	1	24	500	5	-	-	-	-	
	87832-5272	89990-7602	89990-5710	89990-5603	1	24	500	5	-	-	-	-	

<b>QUALITY SYMBOLS</b> 	THIS DRAWING CONTAINS INFORMATION THAT IS PROPRIETARY TO MOLEX ELECTRONIC TECHNOLOGIES, LLC AND SHOULD NOT BE USED WITHOUT WRITTEN PERMISSION																			
	RE-MASTERED IN ELECTRICAL			GENERAL TOLERANCES (UNLESS SPECIFIED)		DIMENSION UNITS		SCALE												
	EC NO: 119993			MM INCH		MM NTS		NTS												
	DRWN: MUM			4 PLACES ± ±		DRWN BY		DATE		<b>PACKAGING SPECIFICATION FOR 87832 IN T&amp;R</b>										
	CHK'D: GMENARLY			3 PLACES ± ±		ATSEE		2015/08/24												
	REV APPR: KHLIM			2 PLACES ± ±		CHK'D BY		DATE		<b>PACKAGING DESIGN DRAWING</b>										
				1 PLACES ± ±		CGOH		2015/08/24												
				0 PLACES ± ±		APPR BY		DATE		<table border="1"> <tr> <td>SERIES</td> <td>MATERIAL NUMBER</td> <td>CUSTOMER</td> </tr> <tr> <td>87832</td> <td>SEE TABLE</td> <td>GENERAL MARKET</td> </tr> </table>				SERIES	MATERIAL NUMBER	CUSTOMER	87832	SEE TABLE	GENERAL MARKET	
	SERIES	MATERIAL NUMBER	CUSTOMER																	
	87832	SEE TABLE	GENERAL MARKET																	
			ANGULAR TOL = 1.0		KHLIM		2017/05/26		<table border="1"> <tr> <td>DOCUMENT NUMBER</td> <td>DOC TYPE</td> <td>DOC PART</td> <td>SHEET NUMBER</td> </tr> <tr> <td>PK-87832-300</td> <td>PDD</td> <td>001</td> <td>3 OF 12</td> </tr> </table>				DOCUMENT NUMBER	DOC TYPE	DOC PART	SHEET NUMBER	PK-87832-300	PDD	001	3 OF 12
DOCUMENT NUMBER	DOC TYPE	DOC PART	SHEET NUMBER																	
PK-87832-300	PDD	001	3 OF 12																	
			DRAFT WHERE APPLICABLE MUST REMAIN WITHIN DIMENSIONS		DRAWING SIZE		THIRD ANGLE PROJECTION													
					A3															

CKTS	PART NUMBER	EMBOSSSED TAPE	REEL	TOP TAPE	OPTION (SEE SHEET 12)	EMBOSS WIDTH	QTY./REEL	REELS/CARTON	BUBBLE SHEETS QTY.			CORNER GUIDES 78888-1251
									TOP	CENTER	BOTTOM	
8	87832-0806	89990-7753	89990-5710	89990-5603	1	24	500	5	-	-	-	-
	87832-0807	89990-7753	89990-5710	89990-5603	1	24	500	5	-	-	-	-
	87832-0814	89990-7603	89990-5710	89990-5603	1	24	500	5	-	-	-	-
	87832-0828	89990-7753	89990-5710	89990-5603	1	24	500	5	-	-	-	-
	87832-0829	89990-7753	89990-5710	89990-5603	1	24	500	5	-	-	-	-
	87832-0836	89990-7753	89990-5710	89990-5603	1	24	500	5	-	-	-	-
	87832-0842	89990-7753	89990-5710	89990-5603	1	24	500	5	-	-	-	-
	87832-5322	89990-7603	89990-5710	89990-5603	1	24	500	5	-	-	-	-
	87832-5323	89990-7603	89990-5710	89990-5603	1	24	500	5	-	-	-	-
	87832-5352	89990-7603	89990-5710	89990-5603	1	24	500	5	-	-	-	-
	87832-5362	89990-7603	89990-5710	89990-5603	1	24	500	5	-	-	-	-
	87832-5372	89990-7603	89990-5710	89990-5603	1	24	500	5	-	-	-	-

THIS DRAWING CONTAINS INFORMATION THAT IS PROPRIETARY TO MOLEX ELECTRONIC TECHNOLOGIES, LLC AND SHOULD NOT BE USED WITHOUT WRITTEN PERMISSION														
<b>QUALITY SYMBOLS</b> 	RE-MASTERED IN ECNTR			EC NO: 119993 DRWN: MUM CHK'D: GMENARLY REV APPR: KHLIM		2017/06/27 2017/08/10 2017/08/10		GENERAL TOLERANCES (UNLESS SPECIFIED) MM    INCH 4 PLACES ±    ± 3 PLACES ±    ± 2 PLACES ±    ± 1 PLACES ±    ± 0 PLACES ±    ±		DIMENSION UNITS    SCALE MM    NTS DRWN BY    DATE ATSEE    2015/08/24 CHK'D BY    DATE CGOH    2015/08/24 APPR BY    DATE KHLIM    2017/05/26		 <b>PACKAGING SPECIFICATION FOR 87832 IN T&amp;R</b>		
	ANGULAR TOL = 1.0 DRAFT WHERE APPLICABLE MUST REMAIN WITHIN DIMENSIONS		DRAWING SIZE    THIRD ANGLE PROJECTION A3		SERIES    MATERIAL NUMBER    CUSTOMER 87832    SEE TABLE    GENERAL MARKET									
	DOCUMENT NUMBER    DOC TYPE    DOC PART    SHEET NUMBER PK-87832-300    PDD    001    4 OF 12													

CKTS	PART NUMBER	EMBOSSSED TAPE	REEL	TOP TAPE	OPTION (SEE SHEET 12)	EMBOSS WIDTH	QTY./REEL	REELS/CARTON	BUBBLE SHEETS QTY.			CORNER GUIDES 78888-1251
									TOP	CENTER	BOTTOM	
10	87832-1006	89990-7754	89990-5710	89990-5603	1	24	500	5	-	-	-	-
	87832-1007	89990-7754	89990-5710	89990-5603	1	24	500	5	-	-	-	-
	87832-1014	89990-7604	89990-5710	89990-5603	1	24	500	5	-	-	-	-
	87832-1028	89990-7754	89990-5710	89990-5603	1	24	500	5	-	-	-	-
	87832-1029	89990-7754	89990-5710	89990-5603	1	24	500	5	-	-	-	-
	87832-1040	89990-7754	89990-5710	89990-5603	1	24	500	5	-	-	-	-
	87832-1042	89990-7754	89990-5710	89990-5603	1	24	500	5	-	-	-	-
	87832-5422	89990-7604	89990-5710	89990-5603	1	24	500	5	-	-	-	-
	87832-5423	89990-7604	89990-5710	89990-5603	1	24	500	5	-	-	-	-
	87832-5462	89990-7604	89990-5710	89990-5603	1	24	500	5	-	-	-	-
	87832-5472	89990-7604	89990-5710	89990-5603	1	24	500	5	-	-	-	-
	87832-9423	89990-7704	89990-5710	89990-5603	2	24	400	5	-	-	-	-

THIS DRAWING CONTAINS INFORMATION THAT IS PROPRIETARY TO MOLEX ELECTRONIC TECHNOLOGIES, LLC AND SHOULD NOT BE USED WITHOUT WRITTEN PERMISSION																						
<b>QUALITY SYMBOLS</b> 	RE-MASTERED IN ECTR		2017/06/27		2017/08/10		2017/08/10		GENERAL TOLERANCES (UNLESS SPECIFIED)		DIMENSION UNITS		SCALE									
	EC NO: 119993		DRWN: MUM		CHK'D: GMENARLY		REV APPR: KHLIM		MM INCH		MM NTS		DRWN BY DATE						<b>PACKAGING SPECIFICATION FOR 87832 IN T&amp;R</b>			
	4 PLACES ± ±		3 PLACES ± ±		2 PLACES ± ±		1 PLACES ± ±		0 PLACES ± ±		ATSEE 2015/08/24		CHK'D BY DATE									
	ANGULAR TOL = 1.0		DRAWING SIZE		THIRD ANGLE PROJECTION		KHLIM 2017/05/26		A3		78732		SEE TABLE		GENERAL MARKET							
	DRAFT WHERE APPLICABLE MUST REMAIN WITHIN DIMENSIONS		A				DOCUMENT NUMBER		DOC TYPE		DOC PART		SHEET NUMBER									
	A		A		A		A		A		A		A		A		A					
	A		A		A		A		A		A		A		A		A					
	A		A		A		A		A		A		A		A		A					
	A		A		A		A		A		A		A		A		A					
	A		A		A		A		A		A		A		A		A					

CKTS	PART NUMBER	EMBOSSSED TAPE	REEL	TOP TAPE	OPTION (SEE SHEET 12)	EMBOSS WIDTH	QTY./REEL	REELS/CARTON	BUBBLE SHEETS QTY.			CORNER GUIDES 78888-1251
									TOP	CENTER	BOTTOM	
12	87832-1206	89990-7755	89990-5711	89990-5604	1	32	500	4	-	-	-	-
	87832-1207	89990-7755	89990-5711	89990-5604	1	32	500	4	-	-	-	-
	87832-1242	89990-7755	89990-5711	89990-5604	1	32	500	4	-	-	-	-
	87832-1228	89990-7755	89990-5711	89990-5604	1	32	500	4	-	-	-	-
	87832-1229	89990-7755	89990-5711	89990-5604	1	32	500	4	-	-	-	-
	87832-5522	89990-7605	89990-5711	89990-5604	1	32	500	4	-	-	-	-
	87832-5523	89990-7605	89990-5711	89990-5604	1	32	500	4	-	-	-	-
	87832-5562	89990-7605	89990-5711	89990-5604	1	32	500	4	-	-	-	-
	87832-5572	89990-7605	89990-5711	89990-5604	1	32	500	4	-	-	-	-
14	87832-1414	89990-7756	89990-5711	89990-5604	1	32	500	4	-	-	-	-
	87832-5622	89990-7756	89990-5711	89990-5604	1	32	500	4	-	-	-	-
	87832-5623	89990-7756	89990-5711	89990-5604	1	32	500	4	-	-	-	-
	87832-5662	89990-7756	89990-5711	89990-5604	1	32	500	4	-	-	-	-
	87832-5672	89990-7756	89990-5711	89990-5604	1	32	500	4	-	-	-	-
	87832-9523	89990-7706	89990-5711	89990-5604	2	32	500	4	-	-	-	-

THIS DRAWING CONTAINS INFORMATION THAT IS PROPRIETARY TO MOLEX ELECTRONIC TECHNOLOGIES, LLC AND SHOULD NOT BE USED WITHOUT WRITTEN PERMISSION											
<b>QUALITY SYMBOLS</b> 	<b>RE-MASTERED IN ELECTR</b> EC NO: 119993 DRWN: MUM CHK'D: GMENARLY REV APPR: KHLIM	<b>GENERAL TOLERANCES (UNLESS SPECIFIED)</b> MM    INCH 4 PLACES ±    ± 3 PLACES ±    ± 2 PLACES ±    ± 1 PLACES ±    ± 0 PLACES ±    ±		<b>DIMENSION UNITS</b> MM	<b>SCALE</b> NTS	 <b>PACKAGING SPECIFICATION FOR 87832 IN T&amp;R</b>					
		<b>DRWN BY</b> <b>DATE</b> ATSEE    2015/08/24		<b>CHK'D BY</b> <b>DATE</b> CGOH    2015/08/24							
		<b>APP'R BY</b> <b>DATE</b> KHLIM    2017/05/26		<b>DRAWING SIZE</b> <b>THIRD ANGLE PROJECTION</b> A3							
		<b>ANGULAR TOL = 1.0</b> <b>DRAFT WHERE APPLICABLE MUST REMAIN WITHIN DIMENSIONS</b>		<b>SERIES</b> <b>MATERIAL NUMBER</b> <b>CUSTOMER</b> 87832    SEE TABLE    GENERAL MARKET							
		<b>DOCUMENT NUMBER</b> <b>DOC TYPE</b> <b>DOC PART</b> <b>SHEET NUMBER</b> PK-87832-300    PDD    001    6 OF 12									

CKTS	PART NUMBER	EMBOSSSED TAPE	REEL	TOP TAPE	OPTION (SEE SHEET 12)	EMBOSS WIDTH	QTY./REEL	REELS/CARTON	BUBBLE SHEETS QTY.			CORNER GUIDES 78888-1251
									TOP	CENTER	BOTTOM	
16	87832-1614	89990-7757	89990-5711	89990-5604	1	32	500	4	-	-	-	-
	87832-5722	89990-7757	89990-5711	89990-5604	1	32	500	4	-	-	-	-
	87832-5723	89990-7757	89990-5711	89990-5604	1	32	500	4	-	-	-	-
	87832-5762	89990-7757	89990-5711	89990-5604	1	32	500	4	-	-	-	-
	87832-5772	89990-7757	89990-5711	89990-5604	1	32	500	4	-	-	-	-
18	87832-1814	89990-7658	89990-5712	89990-5605	3	44	500	3	-	-	-	-
	87832-1815	89990-7658	89990-5712	89990-5605	3	44	500	3	-	-	-	-
	87832-5822	89990-7758	89990-5712	89990-5605	1	44	500	3	-	-	-	-
	87832-5823	89990-7758	89990-5712	89990-5605	1	44	500	3	-	-	-	-
	87832-5862	89990-7758	89990-5712	89990-5605	1	44	500	3	-	-	-	-
	87832-5872	89990-7758	89990-5712	89990-5605	1	44	500	3	-	-	-	-
20	87832-2014	89990-7759	89990-5712	89990-5605	1	44	500	3	-	-	-	-
	87832-5922	89990-7759	89990-5712	89990-5605	1	44	500	3	-	-	-	-
	87832-5923	89990-7759	89990-5712	89990-5605	1	44	500	3	-	-	-	-
	87832-5962	89990-7759	89990-5712	89990-5605	1	44	500	3	-	-	-	-
	87832-5972	89990-7759	89990-5712	89990-5605	1	44	500	3	-	-	-	-

THIS DRAWING CONTAINS INFORMATION THAT IS PROPRIETARY TO MOLEX ELECTRONIC TECHNOLOGIES, LLC AND SHOULD NOT BE USED WITHOUT WRITTEN PERMISSION																																								
<b>QUALITY SYMBOLS</b> 	RE-MASTERED IN ELECTRICAL		2017/06/27		2017/08/10		2017/08/10		GENERAL TOLERANCES (UNLESS SPECIFIED)		DIMENSION UNITS		SCALE																											
	EC NO: 119993		DRWN: MUM		CHK'D: GMENARLY		REV APPR: KHLIM		MM INCH		MM NTS		DRWN BY DATE						<b>PACKAGING SPECIFICATION FOR 87832 IN T&amp;R</b>																					
	4 PLACES ±		3 PLACES ±		2 PLACES ±		1 PLACES ±		0 PLACES ±		ATSEE		2015/08/24										<b>PACKAGING DESIGN DRAWING</b>																	
	ANGULAR TOL = 1.0		DRAWING SIZE		THIRD ANGLE PROJECTION		CGOH		2015/08/24		KHLIM		2017/05/26		<table border="1"> <tr> <td>SERIES</td> <td>MATERIAL NUMBER</td> <td colspan="2">CUSTOMER</td> </tr> <tr> <td>87832</td> <td>SEE TABLE</td> <td colspan="2">GENERAL MARKET</td> </tr> <tr> <td colspan="2">DOCUMENT NUMBER</td> <td>DOC TYPE</td> <td>DOC PART</td> <td>SHEET NUMBER</td> </tr> <tr> <td colspan="2">PK-87832-300</td> <td>PDD</td> <td>001</td> <td>7 OF 12</td> </tr> </table>												SERIES	MATERIAL NUMBER	CUSTOMER		87832	SEE TABLE	GENERAL MARKET		DOCUMENT NUMBER		DOC TYPE	DOC PART	SHEET NUMBER	PK-87832-300
	SERIES	MATERIAL NUMBER	CUSTOMER																																					
	87832	SEE TABLE	GENERAL MARKET																																					
	DOCUMENT NUMBER		DOC TYPE	DOC PART	SHEET NUMBER																																			
	PK-87832-300		PDD	001	7 OF 12																																			
	DRAFT WHERE APPLICABLE MUST REMAIN WITHIN DIMENSIONS		A3				APPR BY DATE		KHLIM		2017/05/26		<table border="1"> <tr> <td>SERIES</td> <td>MATERIAL NUMBER</td> <td colspan="2">CUSTOMER</td> </tr> <tr> <td>87832</td> <td>SEE TABLE</td> <td colspan="2">GENERAL MARKET</td> </tr> <tr> <td colspan="2">DOCUMENT NUMBER</td> <td>DOC TYPE</td> <td>DOC PART</td> <td>SHEET NUMBER</td> </tr> <tr> <td colspan="2">PK-87832-300</td> <td>PDD</td> <td>001</td> <td>7 OF 12</td> </tr> </table>				SERIES	MATERIAL NUMBER	CUSTOMER		87832	SEE TABLE	GENERAL MARKET		DOCUMENT NUMBER		DOC TYPE	DOC PART	SHEET NUMBER	PK-87832-300		PDD	001	7 OF 12						
	SERIES	MATERIAL NUMBER	CUSTOMER																																					
87832	SEE TABLE	GENERAL MARKET																																						
DOCUMENT NUMBER		DOC TYPE	DOC PART	SHEET NUMBER																																				
PK-87832-300		PDD	001	7 OF 12																																				
A		A		A		A		A		A		A		<table border="1"> <tr> <td>RELEASE STATUS</td> <td>P1</td> <td>RELEASE DATE</td> <td>10.08.2017</td> <td>16:20:55</td> </tr> </table>				RELEASE STATUS	P1	RELEASE DATE	10.08.2017	16:20:55																		
RELEASE STATUS	P1	RELEASE DATE	10.08.2017	16:20:55																																				
A		A		A		A		A		A		A						<table border="1"> <tr> <td>RELEASE STATUS</td> <td>P1</td> <td>RELEASE DATE</td> <td>10.08.2017</td> <td>16:20:55</td> </tr> </table>				RELEASE STATUS	P1	RELEASE DATE	10.08.2017	16:20:55														
RELEASE STATUS	P1	RELEASE DATE	10.08.2017	16:20:55																																				
A		A		A		A		A		A		A		<table border="1"> <tr> <td>RELEASE STATUS</td> <td>P1</td> <td>RELEASE DATE</td> <td>10.08.2017</td> <td>16:20:55</td> </tr> </table>								RELEASE STATUS	P1	RELEASE DATE	10.08.2017	16:20:55														
RELEASE STATUS	P1	RELEASE DATE	10.08.2017	16:20:55																																				



CKTS	PART NUMBER	EMBOSSSED TAPE	REEL	TOP TAPE	OPTION (SEE SHEET 12)	EMBOSS WIDTH	QTY./REEL	REELS/CARTON	BUBBLE SHEETS QTY.			CORNER GUIDES 78888-1251
									TOP	CENTER	BOTTOM	
22	87832-6022	89990-7760	89990-5712	89990-5605	1	44	500	3	-	-	-	-
	87832-6023	89990-7760	89990-5712	89990-5605	1	44	500	3	-	-	-	-
	87832-6052	89990-7760	89990-5712	89990-5605	1	44	500	3	-	-	-	-
	87832-6062	89990-7760	89990-5712	89990-5605	1	44	500	3	-	-	-	-
	87832-6072	89990-7760	89990-5712	89990-5605	1	44	500	3	-	-	-	-
24	87832-2414	89990-7761	89990-5712	89990-5605	1	44	500	3	-	-	-	-
	87832-6122	89990-7761	89990-5712	89990-5605	1	44	500	3	-	-	-	-
	87832-6123	89990-7761	89990-5712	89990-5605	1	44	500	3	-	-	-	-
	87832-6162	89990-7761	89990-5712	89990-5605	1	44	500	3	-	-	-	-
	87832-6172	89990-7761	89990-5712	89990-5605	1	44	500	3	-	-	-	-
26	87832-6222	89990-7762	89990-5712	89990-5605	1	44	500	3	-	-	-	-
	87832-6223	89990-7762	89990-5712	89990-5605	1	44	500	3	-	-	-	-
	87832-6262	89990-7762	89990-5712	89990-5605	1	44	500	3	-	-	-	-
	87832-6272	89990-7762	89990-5712	89990-5605	1	44	500	3	-	-	-	-

THIS DRAWING CONTAINS INFORMATION THAT IS PROPRIETARY TO MOLEX ELECTRONIC TECHNOLOGIES, LLC AND SHOULD NOT BE USED WITHOUT WRITTEN PERMISSION												
<b>QUALITY SYMBOLS</b> 	RE-MASTERED IN ECNTR			GENERAL TOLERANCES (UNLESS SPECIFIED)		DIMENSION UNITS		SCALE		 <b>PACKAGING SPECIFICATION FOR 87832 IN T&amp;R</b>		
	EC NO: 119993	2017/06/27	2017/08/10	MM	INCH	MM	NTS	<b>PACKAGING DESIGN DRAWING</b>				
	DRWN: MUM	2017/08/10	2017/08/10	4 PLACES	±	±	DRWN BY				DATE	<b>GENERAL MARKET</b>
	CHK'D: GMENARLY			3 PLACES	±	±	ATSEE	2015/08/24	<b>8 OF 12</b>			
	REV APPR: KHLIM			2 PLACES	±	±	CHK'D BY	DATE				<b>87832</b> <b>SEE TABLE</b> <b>GENERAL MARKET</b>
				1 PLACES	±	±	CGOH	2015/08/24	<b>PK-87832-300</b> <b>PDD</b> <b>001</b> <b>8 OF 12</b>			
				0 PLACES	±	±	APPR BY	DATE				<b>DOCUMENT NUMBER</b> <b>DOC TYPE</b> <b>DOC PART</b> <b>SHEET NUMBER</b>
				ANGULAR TOL = 1.0		DRAWING SIZE		THIRD ANGLE PROJECTION		<b>PK-87832-300</b> <b>PDD</b> <b>001</b> <b>8 OF 12</b>		
				DRAFT WHERE APPLICABLE MUST REMAIN WITHIN DIMENSIONS		A3						

CKTS	PART NUMBER	EMBOSSSED TAPE	REEL	TOP TAPE	OPTION (SEE SHEET 12)	EMBOSS WIDTH	QTY./REEL	REELS/CARTON	BUBBLE SHEETS QTY.			CORNER GUIDES 78888-1251
									TOP	CENTER	BOTTOM	
28	87832-6322	89990-7763	89990-5713	89990-5606	1	56	500	2	-	-	-	-
	87832-6323	89990-7763	89990-5713	89990-5606	1	56	500	2	-	-	-	-
	87832-6362	89990-7763	89990-5713	89990-5606	1	56	500	2	-	-	-	-
	87832-6372	89990-7763	89990-5713	89990-5606	1	56	500	2	-	-	-	-
30	87832-3014	89990-7664	89990-5712	89990-5605	3	56	500	2	-	-	-	-
	87832-6422	89990-7764	89990-5713	89990-5605	1	56	500	2	-	-	-	-
	87832-6423	89990-7764	89990-5713	89990-5605	1	56	500	2	-	-	-	-
	87832-6462	89990-7764	89990-5713	89990-5605	1	56	500	2	-	-	-	-
	87832-6472	89990-7764	89990-5713	89990-5605	1	56	500	2	-	-	-	-
32	87832-6522	89990-7765	89990-5713	89990-5606	1	56	500	2	-	-	-	-
	87832-6523	89990-7765	89990-5713	89990-5606	1	56	500	2	2	2	2	Y
	87832-6562	89990-7765	89990-5713	89990-5606	1	56	500	2	-	-	-	-
	87832-6572	89990-7765	89990-5713	89990-5606	1	56	500	2	-	-	-	-

THIS DRAWING CONTAINS INFORMATION THAT IS PROPRIETARY TO MOLEX ELECTRONIC TECHNOLOGIES, LLC AND SHOULD NOT BE USED WITHOUT WRITTEN PERMISSION											
<b>QUALITY SYMBOLS</b> 	RE-MASTERED IN ELECTR EC NO: 119993 DRWN: MUM CHK'D: GMENARLY REV APPR: KHLIM	GENERAL TOLERANCES (UNLESS SPECIFIED)		DIMENSION UNITS		SCALE		 PACKAGING SPECIFICATION FOR 87832 IN T&R			
		MM	INCH	MM	NTS						
		4 PLACES ±	±	DRWN BY	DATE	PACKAGING DESIGN DRAWING					
		3 PLACES ±	±	ATSEE	2015/08/24						
		2 PLACES ±	±	CHK'D BY	DATE	SERIES: 87832 MATERIAL NUMBER: SEE TABLE CUSTOMER: GENERAL MARKET					
		1 PLACES ±	±	CGOH	2015/08/24						
		0 PLACES ±	±	APPR BY	DATE	DOCUMENT NUMBER: PK-87832-300 DOC TYPE: PDD DOC PART: 001 SHEET NUMBER: 9 OF 12					
		ANGULAR TOL = 1.0		KHLIM	2017/05/26						
		DRAFT WHERE APPLICABLE MUST REMAIN WITHIN DIMENSIONS		DRAWING SIZE	THIRD ANGLE PROJECTION						
				A3							

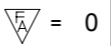
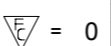
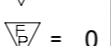
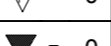
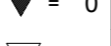
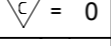
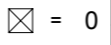
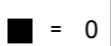
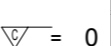
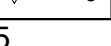
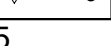
CKTS	PART NUMBER	EMBOSSSED TAPE	REEL	TOP TAPE	OPTION (SEE SHEET 12)	EMBOSS WIDTH	QTY./REEL	REELS/CARTON	BUBBLE SHEETS QTY.			CORNER GUIDES 78888-1251
									TOP	CENTER	BOTTOM	
34	87832-3414	89990-7666	89990-5713	89990-5606	3	56	500	2	-	-	-	-
	87832-6622	89990-7766	89990-5713	89990-5606	1	56	500	2	-	-	-	-
	87832-6623	89990-7766	89990-5713	89990-5606	1	56	500	2	-	-	-	-
	87832-6662	89990-7766	89990-5713	89990-5606	1	56	500	2	-	-	-	-
	87832-6672	89990-7766	89990-5713	89990-5606	1	56	500	2	-	-	-	-
40	87832-6922	89990-7769	89990-5713	89990-5605	1	56	500	2	-	-	-	-
	87832-6923	89990-7769	89990-5713	89990-5605	1	56	500	2	-	-	-	-
	87832-6962	89990-7769	89990-5713	89990-5605	1	56	500	2	-	-	-	-
	87832-6972	89990-7769	89990-5713	89990-5605	1	56	500	2	-	-	-	-
42	87832-7023	151000-4140	89990-5772	89990-5607	1	72	150	2	1	-	1	Y

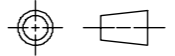
THIS DRAWING CONTAINS INFORMATION THAT IS PROPRIETARY TO MOLEX ELECTRONIC TECHNOLOGIES, LLC AND SHOULD NOT BE USED WITHOUT WRITTEN PERMISSION											
QUALITY SYMBOLS		RE-MASTERED IN ECTR		GENERAL TOLERANCES (UNLESS SPECIFIED)		DIMENSION UNITS		SCALE		 PACKAGING SPECIFICATION FOR 87832 IN T&R	
 = 0	 = 0	2017/06/27	2017/08/10	MM	INCH	MM	NTS				
 = 0	 = 0	2017/08/10	2017/08/10	4 PLACES ± ±		DRWN BY	DATE	PACKAGING DESIGN DRAWING SERIES: 87832 MATERIAL NUMBER: SEE TABLE CUSTOMER: GENERAL MARKET			
 = 0	 = 0	EC NO: 119993	DRWN: MUM	3 PLACES ± ±		ATSEE	2015/08/24				
 = 0	 = 0	CHKD: GMENARLY	REV APPR: KHLIM	2 PLACES ± ±		CHK'D BY	DATE	DOCUMENT NUMBER: PK-87832-300 DOC TYPE: PDD DOC PART: 001 SHEET NUMBER: 10 OF 12			
 = 0	 = 0			1 PLACES ± ±		CGOH	2015/08/24				
 = 0	 = 0			0 PLACES ± ±		APPR BY	DATE				
				ANGULAR TOL = 1.0		KHLIM	2017/05/26				
				DRAFT WHERE APPLICABLE MUST REMAIN WITHIN DIMENSIONS		DRAWING SIZE	THIRD ANGLE PROJECTION				
						A3					

CKTS	PART NUMBER	EMBOSSSED TAPE	REEL	TOP TAPE	OPTION (SEE SHEET 12)	EMBOSS WIDTH	QTY./REEL	REELS/CARTON	BUBBLE SHEETS QTY.			CORNER GUIDES 78888-1251
									TOP	CENTER	BOTTOM	
44	87832-4415	89990-7671	89990-5713	89990-5606	3	56	500	2	-	-	-	-
	87832-7122	89990-7771	89990-5713	89990-5606	1	56	500	2	-	-	-	-
	87832-7123	89990-7771	89990-5713	89990-5606	1	56	500	2	-	-	-	-
	87832-7162	89990-7771	89990-5713	89990-5606	1	56	500	2	-	-	-	-
	87832-7172	89990-7771	89990-5713	89990-5606	1	56	500	2	-	-	-	-
46	87832-7222	89990-7772	89990-5772	89990-5607	1	56	500	2	-	-	-	-
	87832-7262	89990-7772	89990-5772	89990-5607	1	56	500	2	-	-	-	-
	87832-7272	89990-7772	89990-5772	89990-5607	1	56	500	2	-	-	-	-
50	87832-7422	89990-7774	89990-5772	89990-5607	1	56	500	2	-	-	-	-
	87832-7423	89990-7774	89990-5772	89990-5607	1	56	500	2	-	-	-	-
	87832-7462	89990-7774	89990-5772	89990-5607	1	56	500	2	-	-	-	-
	87832-7472	89990-7774	89990-5772	89990-5607	1	56	500	2	-	-	-	-

THIS DRAWING CONTAINS INFORMATION THAT IS PROPRIETARY TO MOLEX ELECTRONIC TECHNOLOGIES, LLC AND SHOULD NOT BE USED WITHOUT WRITTEN PERMISSION													
<b>QUALITY SYMBOLS</b> 	RE-MASTERED IN ELECTRICAL			EC NO: 119993 DRWN: MUM CHK'D: GMENARLY REV APPR: KHLIM		2017/06/27 2017/08/10 2017/08/10		GENERAL TOLERANCES (UNLESS SPECIFIED) MM INCH 4 PLACES ± ± 3 PLACES ± ± 2 PLACES ± ± 1 PLACES ± ± 0 PLACES ± ±		DIMENSION UNITS MM NTS DRWN BY ATSEE DATE 2015/08/24 CHK'D BY CGOH DATE 2015/08/24 APPR BY KHLIM DATE 2017/05/26			
	DIMENSION UNITS: MM NTS SCALE: NTS DRAWING SIZE: A3 THIRD ANGLE PROJECTION								PACKAGING SPECIFICATION FOR 87832 IN T&R				
	ANGULAR TOL = 1.0 DRAFT WHERE APPLICABLE MUST REMAIN WITHIN DIMENSIONS								PACKAGING DESIGN DRAWING				
	SERIES		MATERIAL NUMBER		CUSTOMER		87832		SEE TABLE		GENERAL MARKET		
	DOCUMENT NUMBER				DOC TYPE		DOC PART		SHEET NUMBER				
	PK-87832-300				PDD		001		11 OF 12				

# PACKAGING OPTIONS

OPTION 1

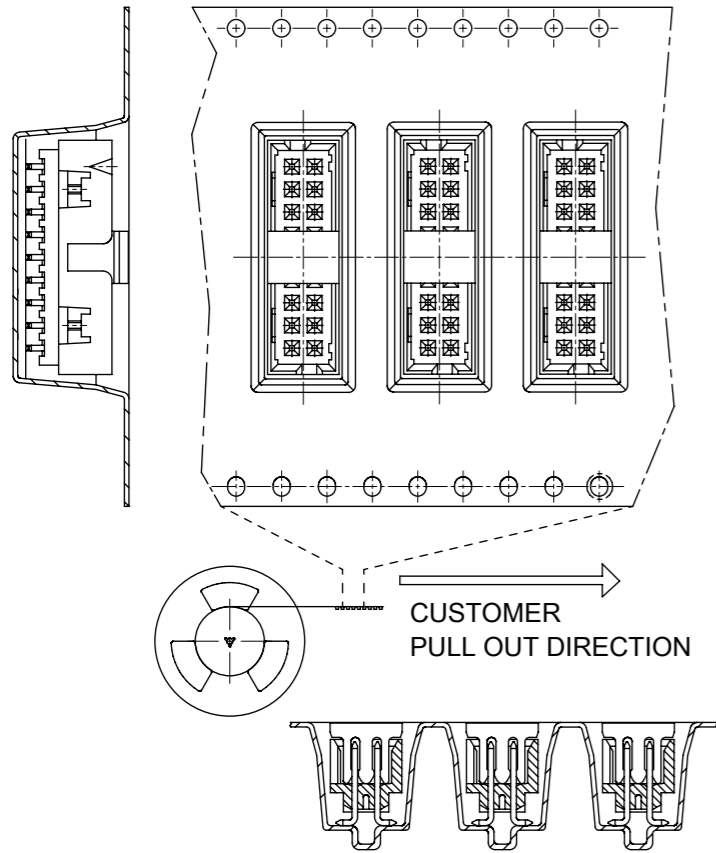

OPTION 2

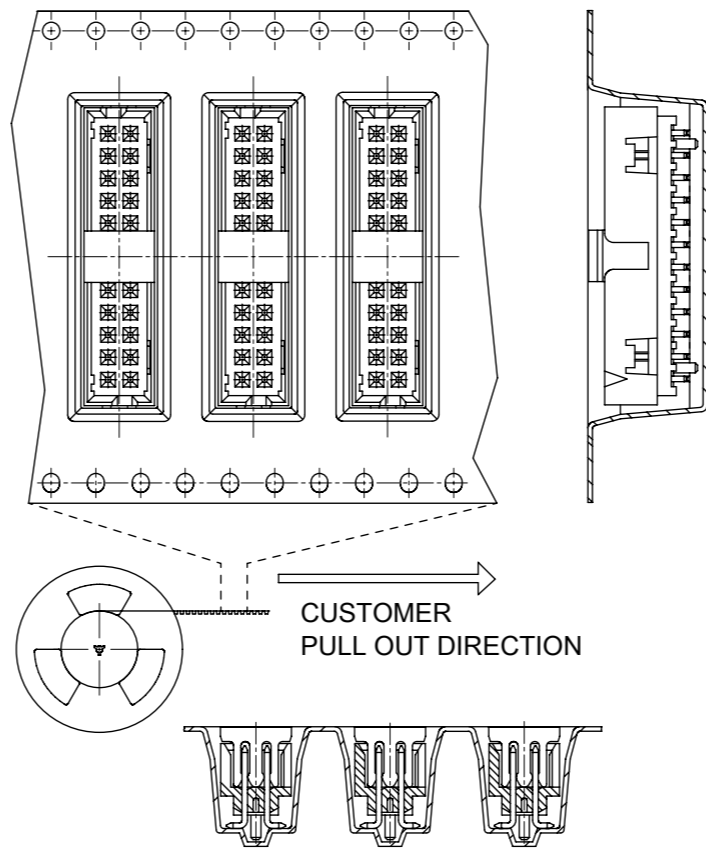

OPTION 3

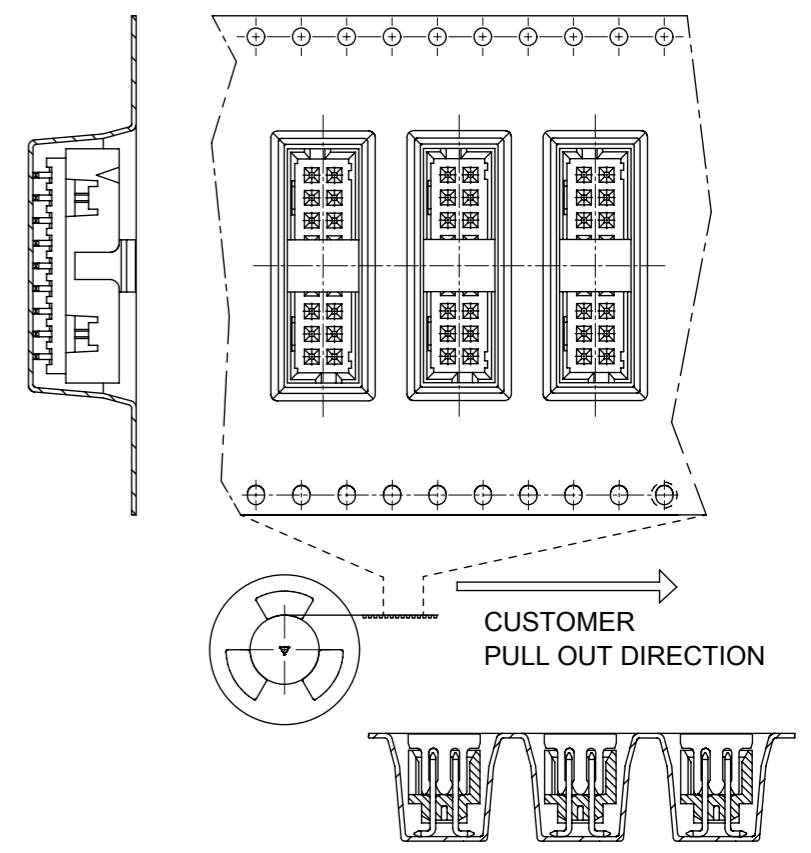

## EMBOSSED TAPE & REEL POCKET DESCRIPTIONS

OPTIONS	CENTER POLARIZATION OPTIONS		PEG OPTIONS		PILOT HOLE OPTIONS	
	ON THE LEFT	ON THE RIGH T	WITH PEG	WITHOUT PEG	2 SIDES	1 SIDE
1	YES	N.A	YES	N.A	CKT 12 - 50	CKT 4 - 10
2	N.A	YES	YES	YES	CKT 12 - 50	CKT 4 - 10
3	YES	N.A	N.A	YES	CKT 12 - 50	CKT 4 - 10

<b>QUALITY SYMBOLS</b> ▽A = 0 ▽C = 0 ▽B = 0 ▼ = 0 ▽C = 0 ⊠ = 0 ■ = 0 ▽ = 0	THIS DRAWING CONTAINS INFORMATION THAT IS PROPRIETARY TO MOLEX ELECTRONIC TECHNOLOGIES, LLC AND SHOULD NOT BE USED WITHOUT WRITTEN PERMISSION										
	RE-MASTERED IN ELECTR EC NO: 119993 DRWN: MUM CHK'D: GMENARLY REV APPR: KHLIM	2017/06/27	2017/08/10	2017/08/10	GENERAL TOLERANCES (UNLESS SPECIFIED)		DIMENSION UNITS		SCALE		
					MM	INCH	MM	NTS			
		4 PLACES	±	±	DRWN BY	DATE				PACKAGING SPECIFICATION FOR 87832 IN T&R  PACKAGING DESIGN DRAWING	
		3 PLACES	±	±	ATSEE	2015/08/24					
		2 PLACES	±	±	CHK'D BY	DATE					
	1 PLACES	±	±	CGOH	2015/08/24						
	0 PLACES	±	±	APPR BY	DATE				SERIES: 87832 MATERIAL NUMBER: SEE TABLE CUSTOMER: GENERAL MARKET		
	ANGULAR TOL = 1.0		DRAFT WHERE APPLICABLE MUST REMAIN WITHIN DIMENSIONS		KHLIM		2017/05/26				
					DRAWING SIZE: A3		THIRD ANGLE PROJECTION				
								DOCUMENT NUMBER: PK-87832-300			
								DOC TYPE: PDD			
								DOC PART: 001			
								SHEET NUMBER: 12 OF 12			

## Looking for pricing, stock, or lifecycle information?

Click below to explore more details on WIN SOURCE:

 [View 0878321042 on WIN SOURCE](#)

 [Molex, LLC Information](#)

## Optimize Your Supply Chain with WIN SOURCE Solutions

-  Global Sourcing Solution
-  Obsolete Management
-  Cost Control Management
-  Shortage Management
-  Alternative Solution
-  Excess Inventory Management