



**THE DATASHEET OF  
2N4393-E3**





## N-Channel JFETs

<b>2N4391</b>	<b>PN4391</b>	<b>SST4391</b>
<b>2N4392</b>	<b>PN4392</b>	<b>SST4392</b>
<b>2N4393</b>	<b>PN4393</b>	<b>SST4393</b>

PRODUCT SUMMARY				
Part Number	$V_{GS(off)}$ (V)	$r_{DS(on)}$ Max ( $\Omega$ )	$I_{D(off)}$ Typ ( $\mu$ A)	$t_{ON}$ Typ (ns)
2N/PN/SST4391	-4 to -10	30	5	4
2N/PN/SST4392	-2 to -5	60	5	4
2N/PN/SST4393	-0.5 to -3	100	5	4

### FEATURES

- Low On-Resistance: 4391 < 30  $\Omega$
- Fast Switching— $t_{ON}$ : 4 ns
- High Off-Isolation:  $I_{D(off)}$  with Low Leakage
- Low Capacitance: < 3.5 pF
- Low Insertion Loss

### BENEFITS

- Low Error Voltage
- High-Speed Analog Circuit Performance
- Negligible “Off-Error,” Excellent Accuracy
- Good Frequency Response, Low Glitches
- Eliminates Additional Buffering

### APPLICATIONS

- Analog Switches
- Choppers
- Sample-and-Hold
- Normally “On” Switches
- Current Limiters
- Commutators

### DESCRIPTION

The 2N/PN/SST4391 series features many of the superior characteristics of JFETs which make it a good choice for demanding analog switching applications and for specialized amplifier circuits.

The 2N series hermetically-sealed TO-206AA (TO-18) can be available with processing per MIL-S-19500 (see Military Information). Both the PN, TO-226AA (TO-92), and SST, TO-236 (SOT-23), series are available in tape-and-reel for automated assembly (see Packaging Information). For similar dual products, see the 2N5564/5565/5566 data sheet.

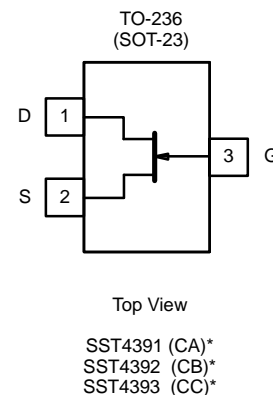
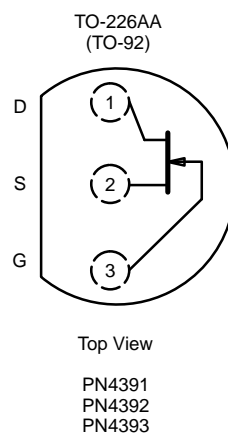
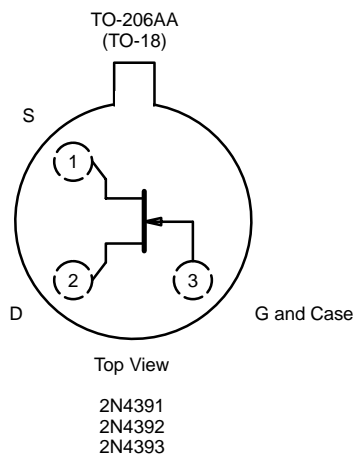

\*Marking Code for TO-236

For applications information see AN104 and AN106



### ABSOLUTE MAXIMUM RATINGS

Gate-Drain, Gate-Source Voltage:	
(2N/PN Prefixes)	−40 V
(SST Prefix)	−35 V
Gate Current	50 mA
Lead Temperature	300 °C
Storage Temperature :	(2N Prefix) −65 to 200 °C
	(PN/SST Prefixes) −55 to 150 °C

Operating Junction Temperature :	
(2N Prefix)	−55 to 200 °C
(PN/SST Prefixes)	−55 to 150 °C
Power Dissipation :	(2N Prefix) <sup>a</sup> (T <sub>C</sub> = 25 °C) 1800 mW
	(PN/SST Prefixes) <sup>b</sup> 350 mW

- Notes
- Derate 10 mW/°C above 25 °C
  - Derate 2.8 mW/°C above 25 °C

### SPECIFICATIONS (T<sub>A</sub> = 25 °C UNLESS OTHERWISE NOTED)

Parameter	Symbol	Test Conditions	Typ <sup>a</sup>	Limits						Unit		
				4391		4392		4393				
				Min	Max	Min	Max	Min	Max			
<b>Static</b>												
Gate-Source Breakdown Voltage	V <sub>(BR)GSS</sub>	I <sub>G</sub> = −1 μA, V <sub>DS</sub> = 0 V	−55	−40		−40		−40		V		
Gate-Source Cutoff Voltage	V <sub>GS(off)</sub>	V <sub>DS</sub> = 20 V	2N/PN: I <sub>D</sub> = 1 nA	−4	−10	−2	−5	−0.5	−3	V		
		V <sub>DS</sub> = 15 V	SST: I <sub>D</sub> = 10 nA									
Saturation Drain Current <sup>b</sup>	I <sub>DSS</sub>	V <sub>DS</sub> = 20 V, V <sub>GS</sub> = 0 V	2N	50	150	25	75	5	30	mA		
			PN	50	150	25	100	5	60			
			SST	50		25		5				
Gate Reverse Current	I <sub>GSS</sub>	V <sub>GS</sub> = −20 V V <sub>DS</sub> = 0 V	2N/SST	−5	−100		−100		−100	pA		
			PN	−5	−1000		−1000		−1000			
			2N: T <sub>A</sub> = 150 °C	−13	−200		−200		−200	nA		
			PN: T <sub>A</sub> = 100 °C	−1	−200		−200		−200			
Gate Operating Current	I <sub>G</sub>	V <sub>DG</sub> = 15 V, I <sub>D</sub> = 10 mA		−5								
Drain Cutoff Current	I <sub>D(off)</sub>	V <sub>DS</sub> = 20 V	2N: V <sub>GS</sub> = −5 V	5					100	pA		
			2N: V <sub>GS</sub> = −7 V	5			100					
			2N: V <sub>GS</sub> = −12 V	5		100						
			PN: V <sub>GS</sub> = −5 V	0.005					1	nA		
			PN: V <sub>GS</sub> = −7 V	0.005				1				
			PN: V <sub>GS</sub> = −12 V	0.005			1					
				SST V <sub>DS</sub> = 10 V, V <sub>GS</sub> = −10 V	5		100		100	100	pA	
				V <sub>DS</sub> = 20 V T <sub>A</sub> = 150 °C	2N: V <sub>GS</sub> = −5 V	13					200	nA
					2N: V <sub>GS</sub> = −7 V	13				200		
					2N: V <sub>GS</sub> = −12 V	13		200				
		V <sub>DS</sub> = 20 V T <sub>A</sub> = 100 °C	PN: V <sub>GS</sub> = −5 V	1					200			
			PN: V <sub>GS</sub> = −7 V	1				200				
			PN: V <sub>GS</sub> = −12 V	1		200						
		V <sub>DS</sub> = 10 V T <sub>A</sub> = 125 °C	SST: V <sub>GS</sub> = −10 V	3								
Drain-Source On-Voltage	V <sub>DS(on)</sub>	V <sub>GS</sub> = 0 V	I <sub>D</sub> = 3 mA	0.25					0.4	V		
			I <sub>D</sub> = 6 mA	0.3				0.4				
			I <sub>D</sub> = 12 mA	0.35			0.4					
Drain-Source On-Resistance	r <sub>DS(on)</sub>	V <sub>GS</sub> = 0 V, I <sub>D</sub> = 1 mA			30		60		100	Ω		
Gate-Source Forward Voltage	V <sub>GS(F)</sub>	I <sub>G</sub> = 1 mA V <sub>DS</sub> = 0 V	2N	0.7		1		1		1	V	
			PN/SST	0.7								



SPECIFICATIONS (T <sub>A</sub> = 25 °C UNLESS OTHERWISE NOTED)											
Parameter	Symbol	Test Conditions	Typ <sup>a</sup>	Limits						Unit	
				4391		4392		4393			
				Min	Max	Min	Max	Min	Max		
<b>Dynamic</b>											
Common-Source Forward Transconductance	g <sub>fs</sub>	V <sub>DS</sub> = 20 V, I <sub>D</sub> = 1 mA, f = 1 kHz	6							mS	
Common-Source Output Conductance	g <sub>os</sub>		25							μS	
Drain-Source On-Resistance	r <sub>DS(on)</sub>	V <sub>GS</sub> = 0 V, I <sub>D</sub> = 0 mA, f = 1 kHz			30		60		100	Ω	
Common-Source Input Capacitance	C <sub>iss</sub>	V <sub>DS</sub> = 20 V, V <sub>GS</sub> = 0 V f = 1 MHz	2N	12		14		14		14	
			PN	12		16		16		16	
			SST	13							
Common-Source Reverse Transfer Capacitance	C <sub>rss</sub>	V <sub>DS</sub> = 0 V f = 1 MHz	2N: V <sub>GS</sub> = -5 V	3.3						3.5	pF
			2N: V <sub>GS</sub> = -7 V	3.2				3.5			
			2N: V <sub>GS</sub> = -12 V	2.8		3.5					
			PN: V <sub>GS</sub> = -5 V	3.5						5	
			PN: V <sub>GS</sub> = -7 V	3.4				5			
			PN: V <sub>GS</sub> = -12 V	3.0		5					
			SST: V <sub>GS</sub> = -5 V	3.6							
			SST: V <sub>GS</sub> = -12 V	3.1							
Equivalent Input Noise Voltage	e <sub>n</sub>	V <sub>DS</sub> = 10 V, I <sub>D</sub> = 10 mA f = 1 kHz	3							nV/ √Hz	
<b>Switching</b>											
Turn-On Time	t <sub>d(on)</sub>	V <sub>DD</sub> = 10 V V <sub>GS(H)</sub> = 0 V See Switching Circuit	2N/PN	2		15		15		15	ns
	t <sub>r</sub>		SST	2							
Turn-Off Time	t <sub>d(off)</sub>		2N/PN	2		5		5		5	
			SST	2							
	t <sub>f</sub>		2N/PN	6		20		35		50	
			SST	6							
		2N/PN	13		15		20		30		
		SST	13								

Notes

- a. Typical values are for DESIGN AID ONLY, not guaranteed nor subject to production testing.
- b. Pulse test: PW ≤ 300 μs duty cycle ≤ 3%.

NCB

### TYPICAL CHARACTERISTICS ( $T_A = 25^\circ\text{C}$ UNLESS OTHERWISE NOTED)

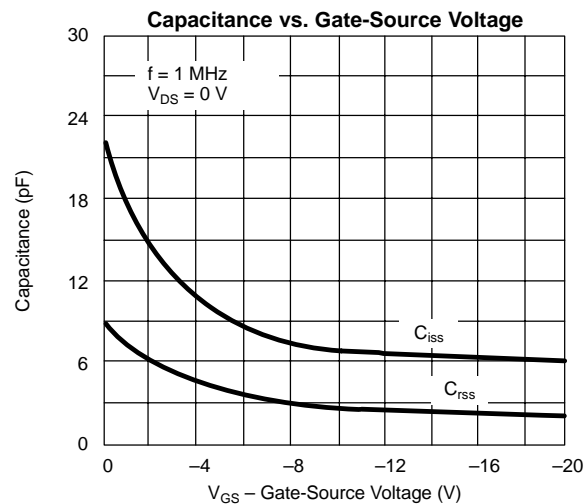
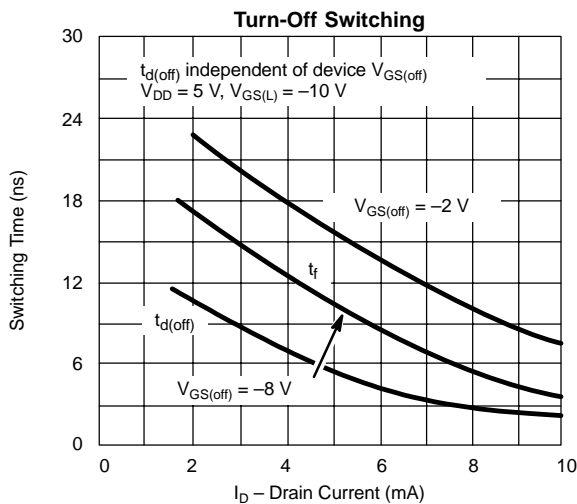
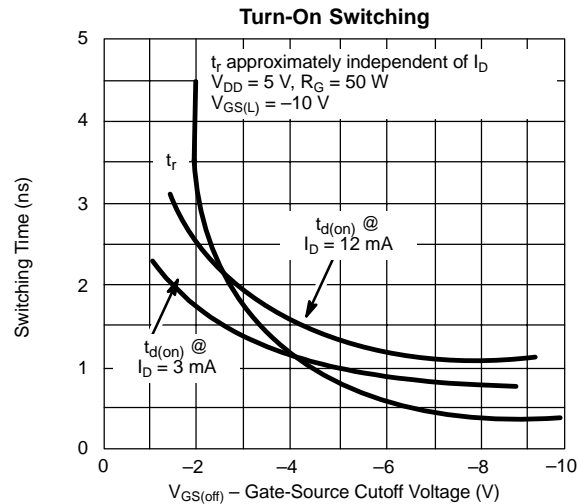
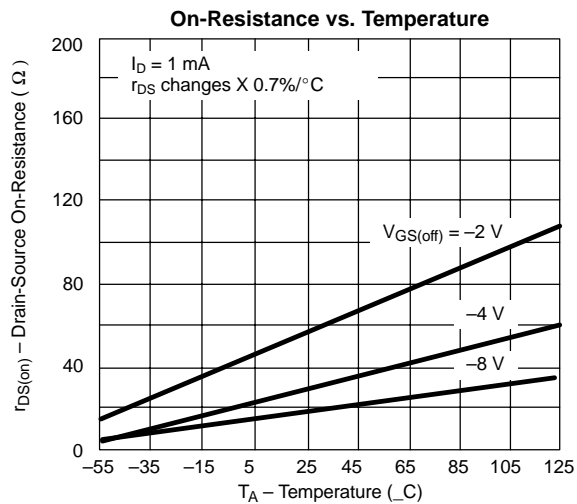
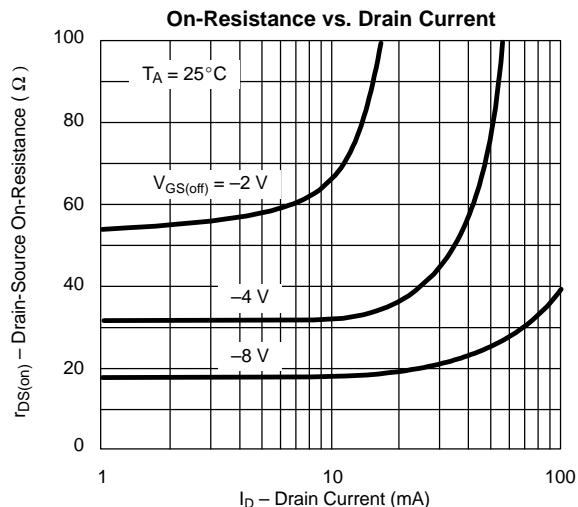
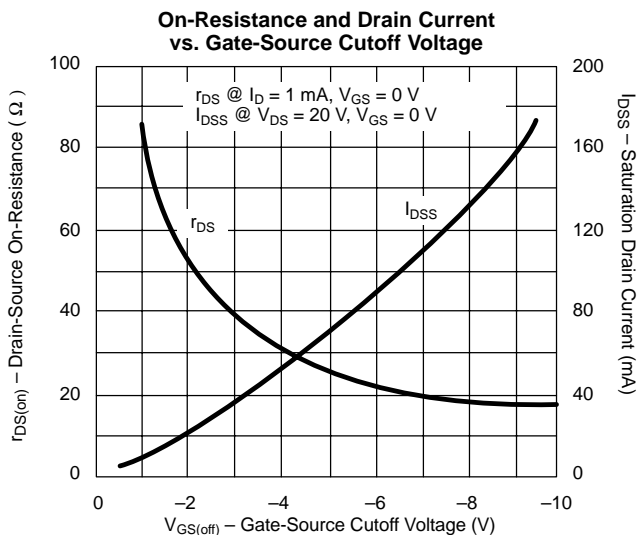



**TYPICAL CHARACTERISTICS (T<sub>A</sub> = 25 °C UNLESS OTHERWISE NOTED)**

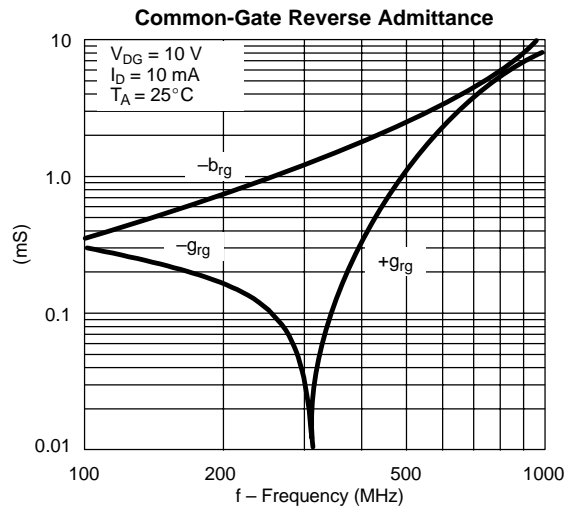
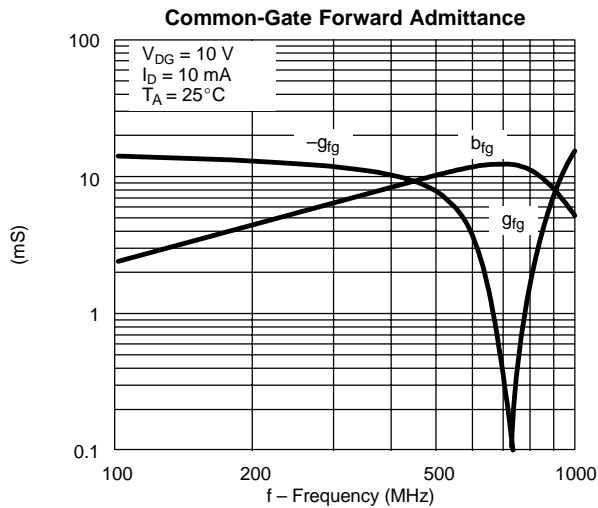
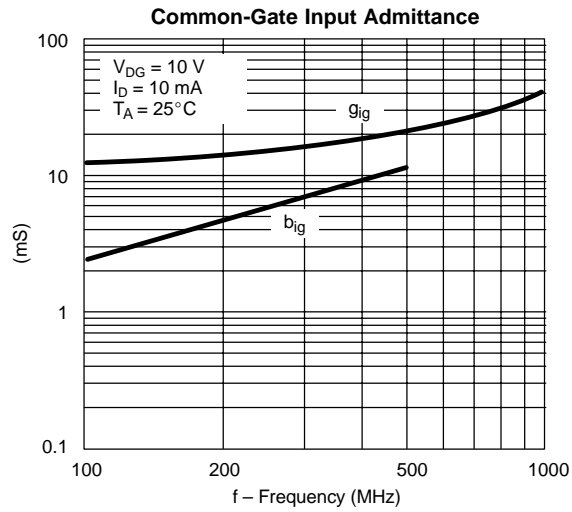
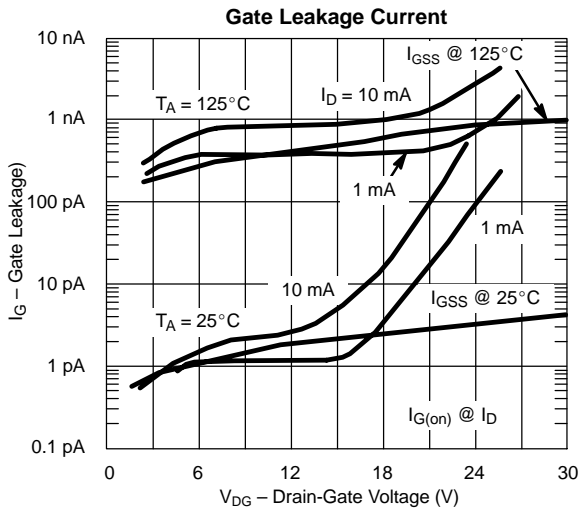
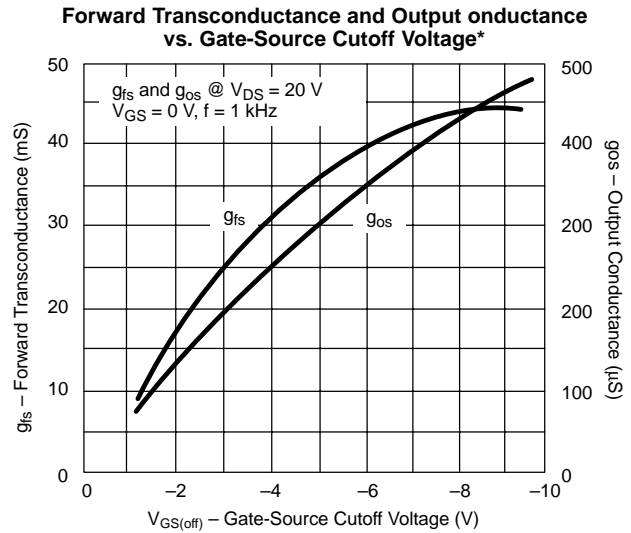
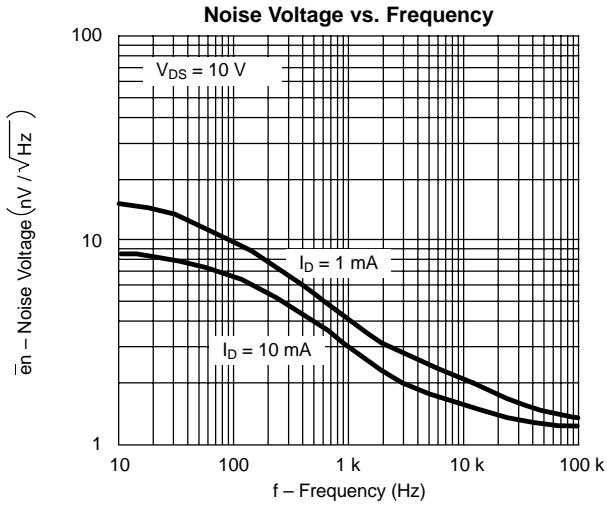

### TYPICAL CHARACTERISTICS ( $T_A = 25^\circ\text{C}$ UNLESS OTHERWISE NOTED)

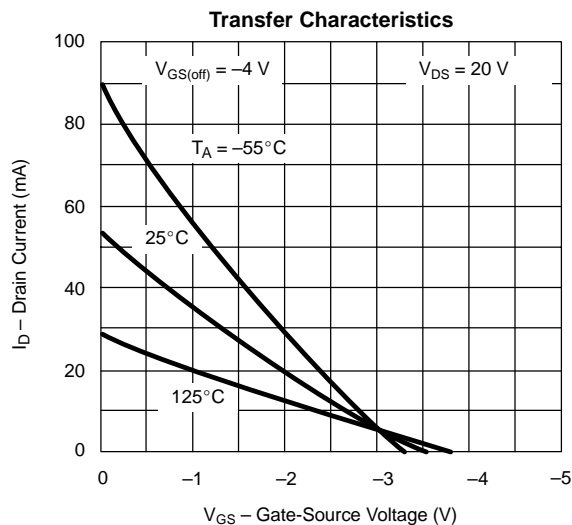
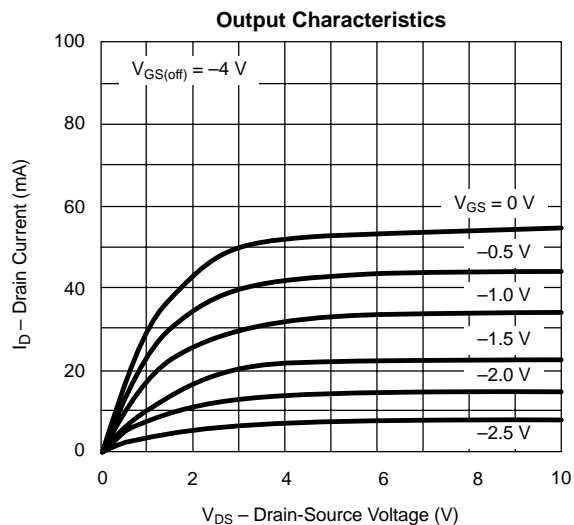
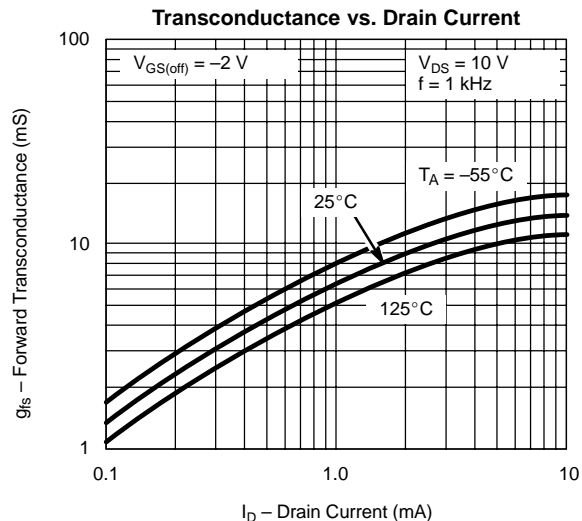
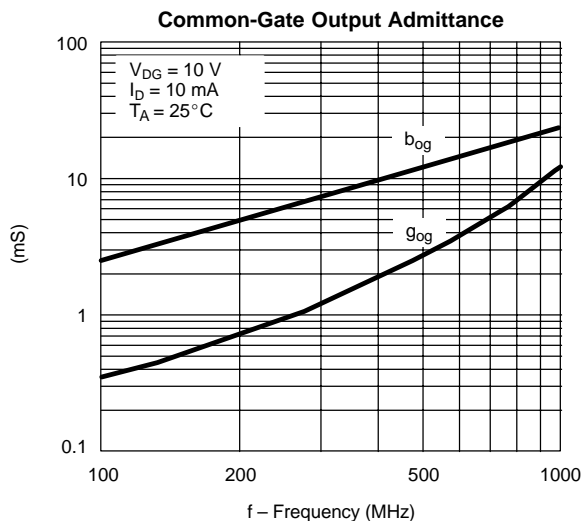

SWITCHING TIME TEST CIRCUIT			
	4391	4392	4393
$V_{GS(L)}$	-12 V	-7 V	-5 V
$R_L^*$	800 $\Omega$	1600 $\Omega$	3000 $\Omega$
$I_{D(on)}$	12 mA	6 mA	3 mA

\*Non-inductive

#### INPUT PULSE

Rise Time < 1 ns  
Fall Time < 1 ns  
Pulse Width 100 ns  
PRF 1 MHz

#### SAMPLING SCOPE

Rise Time 0.4 ns  
Input Resistance 10 M $\Omega$   
Input Capacitance 1.5 pF

See Typical Characteristics curves for changes.

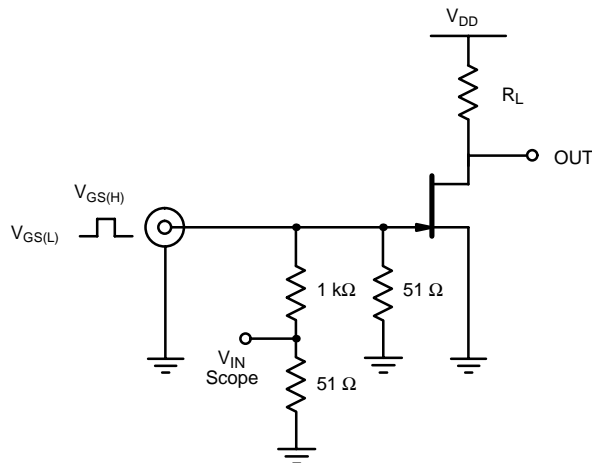



## Disclaimer

All product specifications and data are subject to change without notice.

Vishay Intertechnology, Inc., its affiliates, agents, and employees, and all persons acting on its or their behalf (collectively, "Vishay"), disclaim any and all liability for any errors, inaccuracies or incompleteness contained herein or in any other disclosure relating to any product.

Vishay disclaims any and all liability arising out of the use or application of any product described herein or of any information provided herein to the maximum extent permitted by law. The product specifications do not expand or otherwise modify Vishay's terms and conditions of purchase, including but not limited to the warranty expressed therein, which apply to these products.

No license, express or implied, by estoppel or otherwise, to any intellectual property rights is granted by this document or by any conduct of Vishay.

The products shown herein are not designed for use in medical, life-saving, or life-sustaining applications unless otherwise expressly indicated. Customers using or selling Vishay products not expressly indicated for use in such applications do so entirely at their own risk and agree to fully indemnify Vishay for any damages arising or resulting from such use or sale. Please contact authorized Vishay personnel to obtain written terms and conditions regarding products designed for such applications.

Product names and markings noted herein may be trademarks of their respective owners.

## Looking for pricing, stock, or lifecycle information?

Click below to explore more details on WIN SOURCE:

 [View 2N4393-E3 on WIN SOURCE](#)

 [Vishay Information](#)

## Optimize Your Supply Chain with WIN SOURCE Solutions

-  Global Sourcing Solution
-  Obsolete Management
-  Cost Control Management
-  Shortage Management
-  Alternative Solution
-  Excess Inventory Management