



# THE DATASHEET OF BCR191



**Silicon Switching Diode**

- For high-speed switching applications
- Series pair configuration
- BAV99S / U: For orientation in reel see package information below
- Pb-free (RoHS compliant) package<sup>1)</sup>
- Qualified according AEC Q101

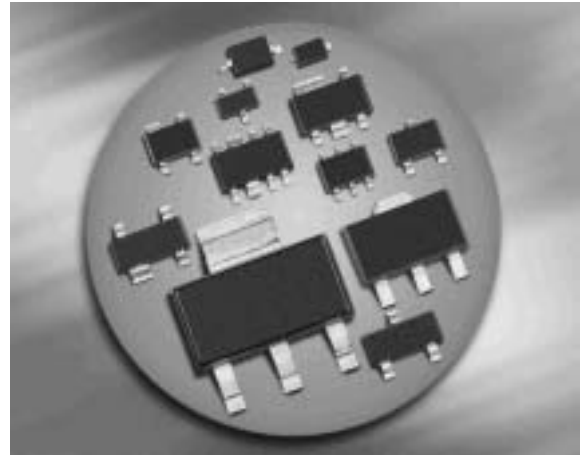
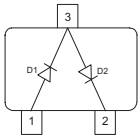
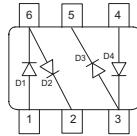
**BAV99**  
**BAV99W**

**BAV99S**  
**BAV99U**

Type	Package	Configuration	Marking
BAV99	SOT23	series	A7s
BAV99S	SOT363	dual series	A7s
BAV99U	SC74	dual series	A7s
BAV99W	SOT323	series	A7s

<sup>1</sup>Pb-containing package may be available upon special request

**Maximum Ratings** at  $T_A = 25^\circ\text{C}$ , unless otherwise specified

Parameter	Symbol	Value	Unit
Diode reverse voltage	$V_R$	80	V
Peak reverse voltage	$V_{RM}$	85	
Forward current	$I_F$	200	mA
Non-repetitive peak surge forward current	$I_{FSM}$		A
$t = 1 \mu\text{s}$		4.5	
$t = 1 \text{ ms}$		1	
$t = 1 \text{ s, single}$		0.5	
$t = 1 \text{ s, double}$		0.75	
Total power dissipation	$P_{tot}$		mW
BAV99, $T_S \leq 28^\circ\text{C}$		330	
BAV99S, $T_S \leq 85^\circ\text{C}$		250	
BAV99U, $T_S \leq 113^\circ\text{C}$		250	
BAV99W, $T_S \leq 110^\circ\text{C}$		250	
Junction temperature	$T_j$	150	$^\circ\text{C}$
Storage temperature	$T_{stg}$	-65 ... 150	

**Thermal Resistance**

Parameter	Symbol	Value	Unit
Junction - soldering point <sup>1)</sup>	$R_{thJS}$		K/W
BAV99		$\leq 360$	
BAV99S		$\leq 260$	
BAV99U		$\leq 150$	
BAV99W		$\leq 160$	

<sup>1)</sup>For calculation of  $R_{thJA}$  please refer to Application Note Thermal Resistance

**Electrical Characteristics at  $T_A = 25^\circ\text{C}$ , unless otherwise specified**

Parameter	Symbol	Values			Unit
		min.	typ.	max.	
<b>DC Characteristics</b>					
Breakdown voltage $I_{(BR)} = 100 \mu\text{A}$	$V_{(BR)}$	85	-	-	V
Reverse current $V_R = 70 \text{ V}$ $V_R = 25 \text{ V}, T_A = 150^\circ\text{C}$ $V_R = 70 \text{ V}, T_A = 150^\circ\text{C}$	$I_R$	-	-	0.15 30 50	$\mu\text{A}$
Forward voltage $I_F = 1 \text{ mA}$ $I_F = 10 \text{ mA}$ $I_F = 50 \text{ mA}$ $I_F = 100 \text{ mA}$ $I_F = 150 \text{ mA}$	$V_F$	-	-	715 855 1000 1200 1250	mV

**Electrical Characteristics at  $T_A = 25^\circ\text{C}$ , unless otherwise specified**

Parameter	Symbol	Values			Unit
		min.	typ.	max.	
<b>AC Characteristics</b>					
Diode capacitance $V_R = 0 \text{ V}, f = 1 \text{ MHz}$	$C_T$	-	-	1.5	pF
Reverse recovery time $I_F = 10 \text{ mA}, I_R = 10 \text{ mA}$ , measured at $I_R = 1 \text{ mA}$ , $R_L = 100 \Omega$	$t_{rr}$	-	-	4	ns

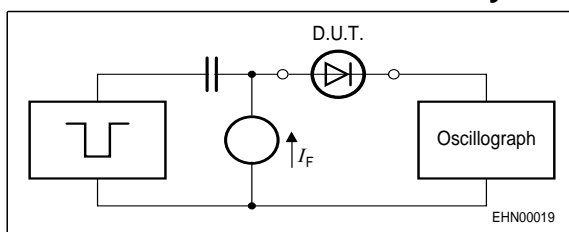
**Test circuit for reverse recovery time**

Pulse generator:  $t_p = 100\text{ns}$ ,  $D = 0.05$ ,  
 $t_r = 0.6\text{ns}$ ,  $R_i = 50\Omega$

Oscilloscope:  $R = 50$ ,  $t_r = 0.35\text{ns}$   
 $C \leq 1\text{pF}$

**Reverse current  $I_R = f(T_A)$**

$V_R = \text{Parameter}$

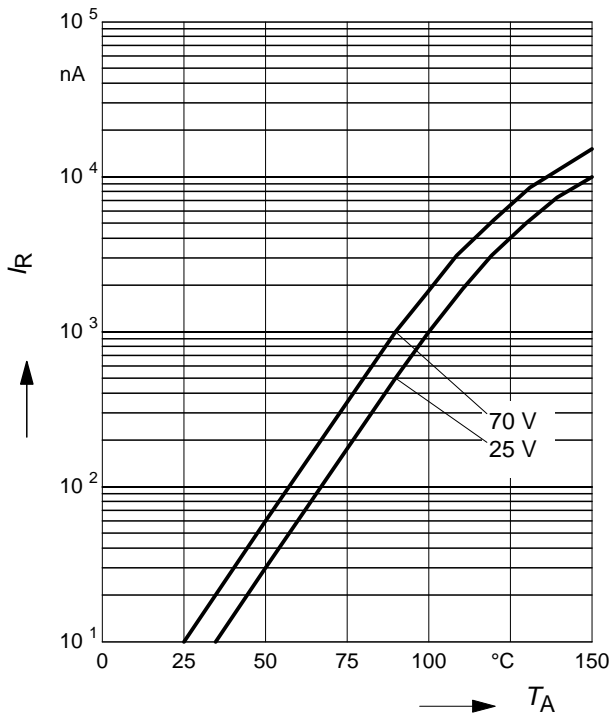

**Forward Voltage  $V_F = f(T_A)$**

$I_F = \text{Parameter}$

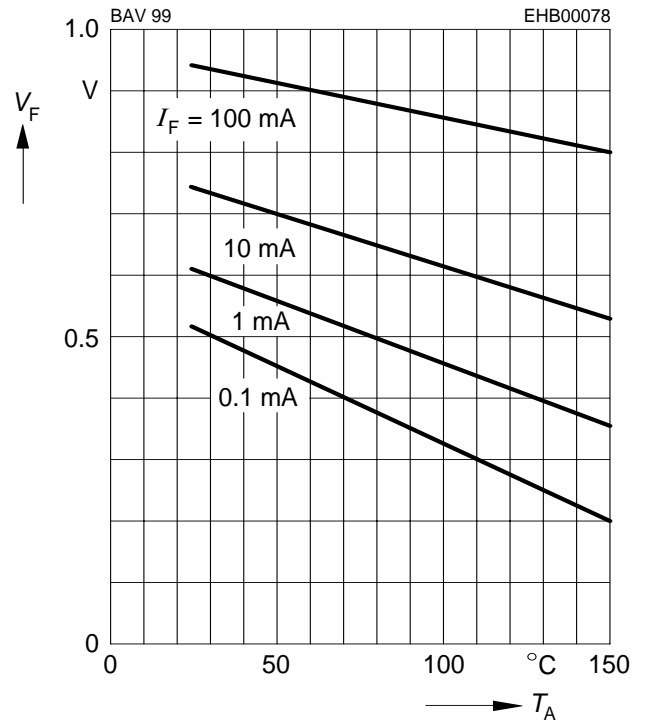

**Forward current  $I_F = f(V_F)$**

$T_A = 25^\circ\text{C}$

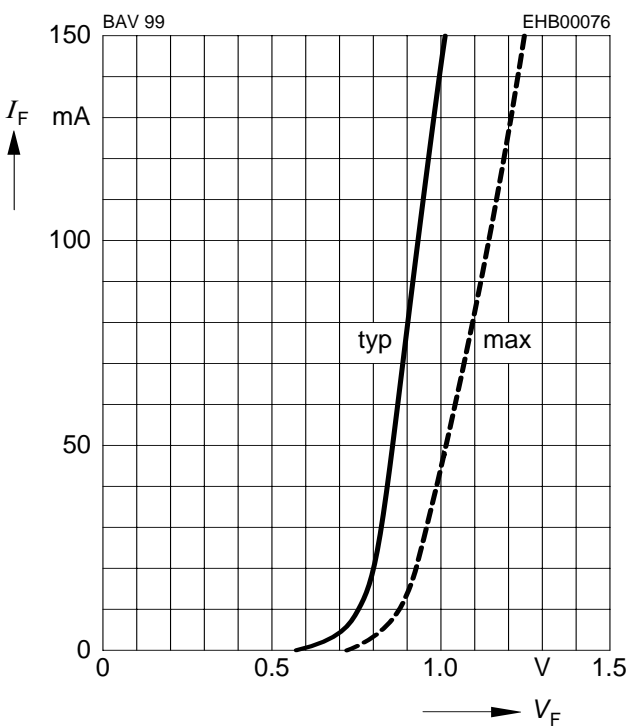

**Forward current  $I_F = f(T_S)$**

BAV99

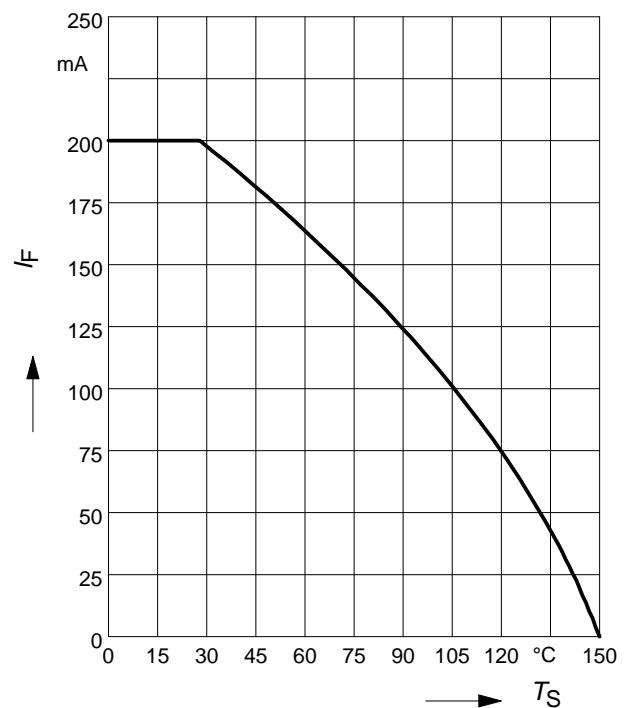

**Forward current  $I_F = f(T_S)$**

BAV99S

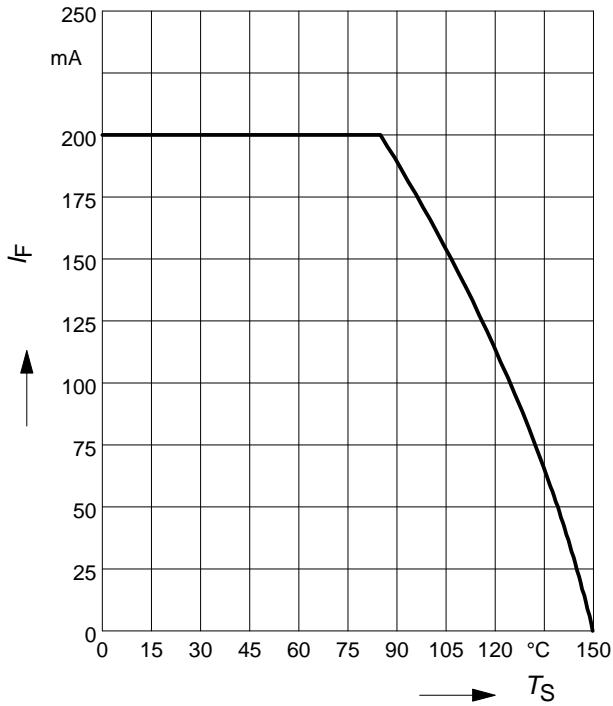

**Forward current  $I_F = f(T_S)$**

BAV99U

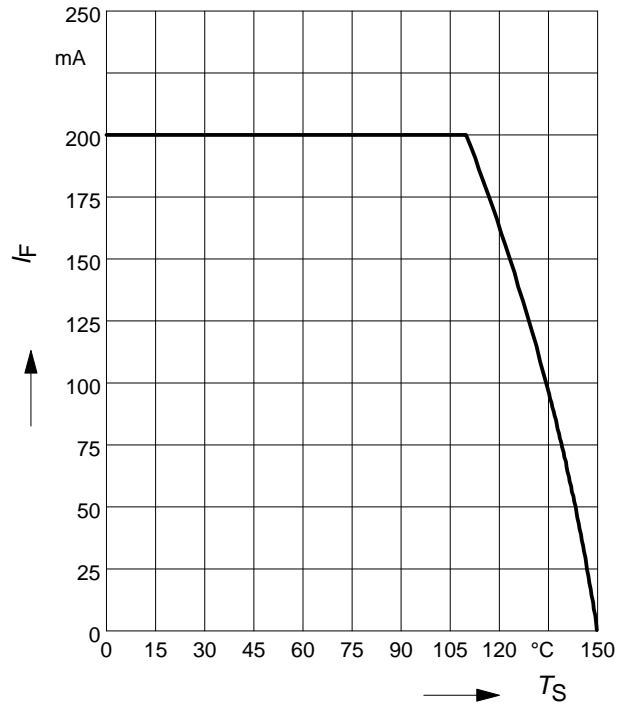

**Forward current  $I_F = f(T_S)$**

BAV99W

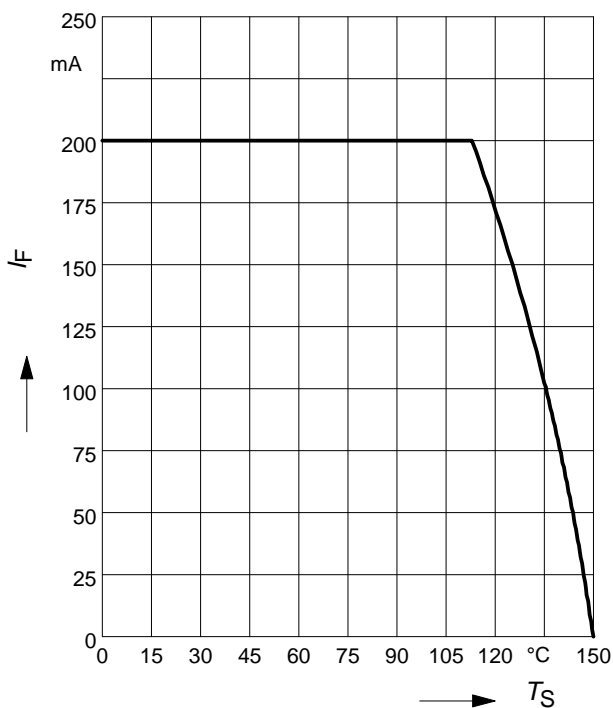

**Permissible Puls Load  $R_{thJS} = f(t_p)$**

BAV99

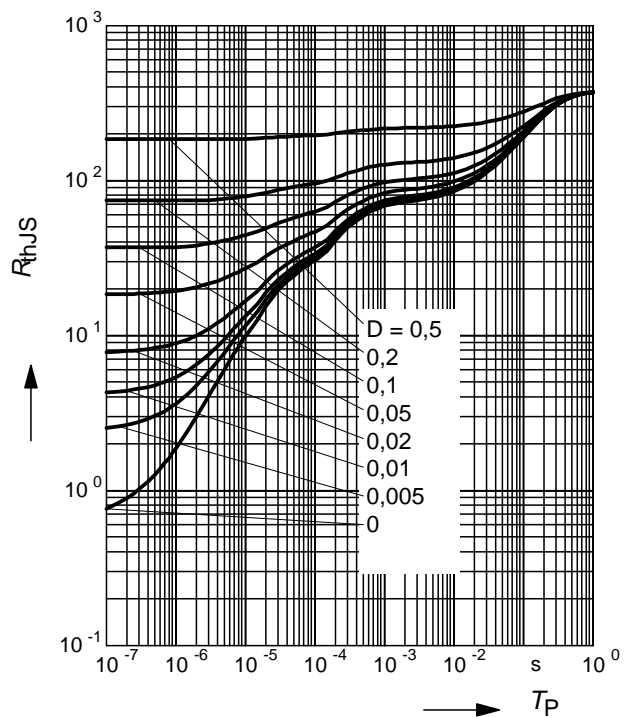

**Permissible Pulse Load**

$$I_{Fmax} / I_{FDC} = f(t_p)$$

BAV99

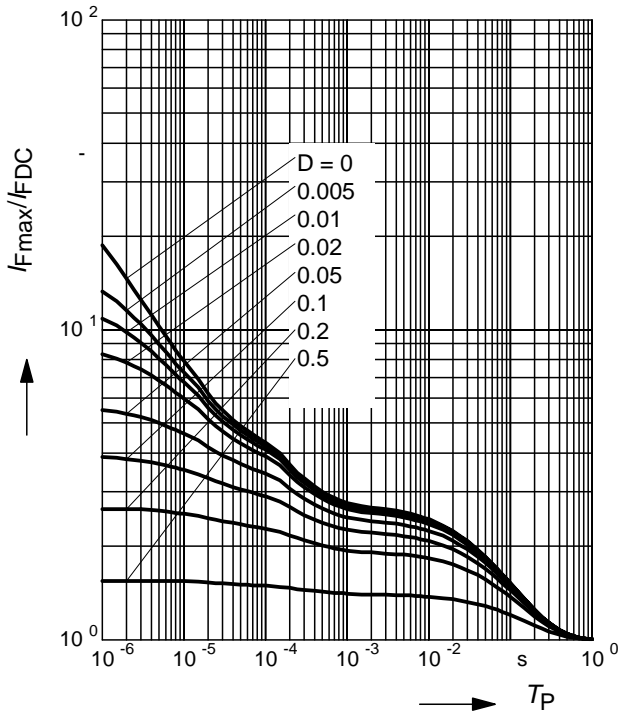

**Permissible Puls Load  $R_{thJS} = f(t_p)$**

BAV99S

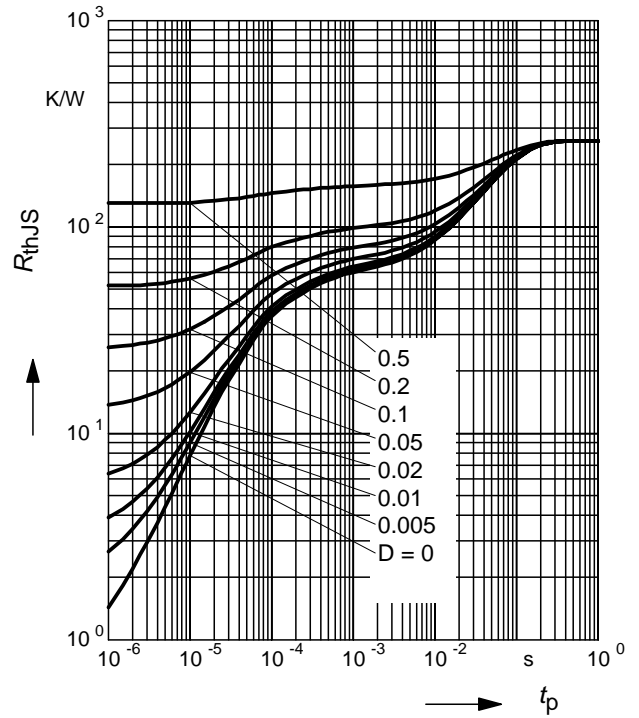

**Permissible Pulse Load**

$$I_{Fmax} / I_{FDC} = f(t_p)$$

BAV99S

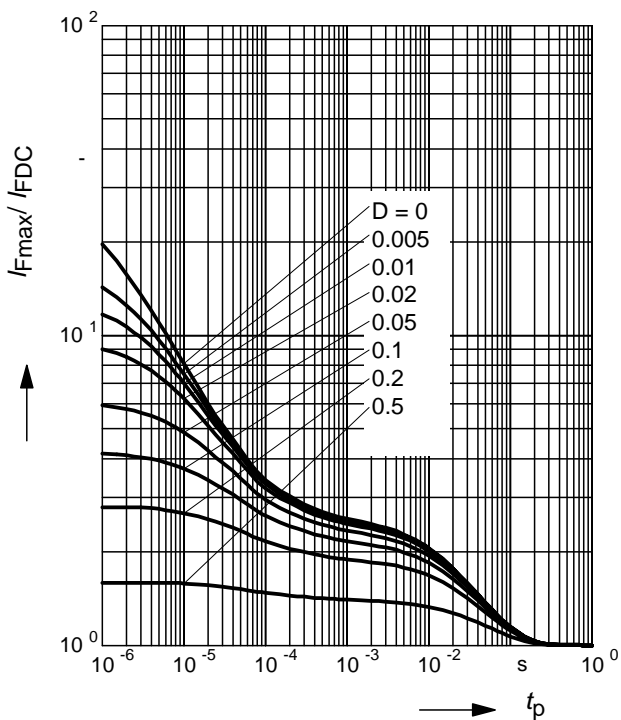

**Permissible Puls Load  $R_{thJS} = f(t_p)$**

BAV99U

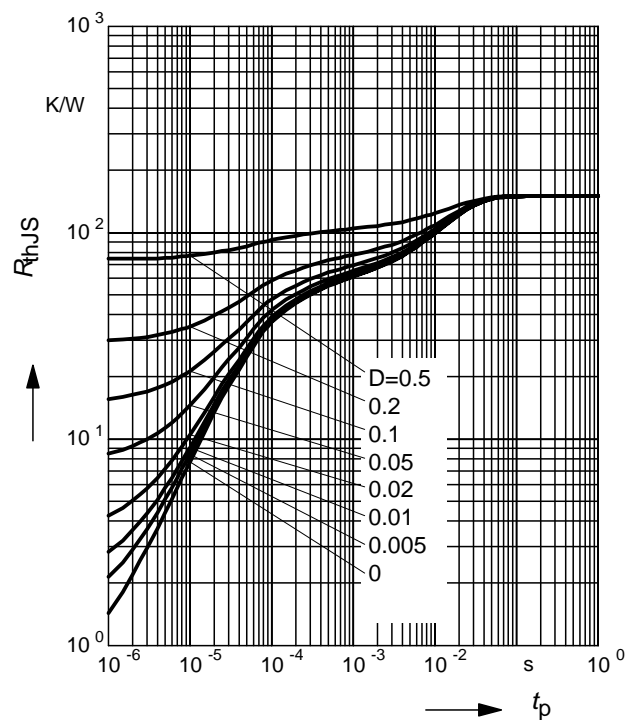

**Permissible Pulse Load**

$$I_{Fmax} / I_{FDC} = f(t_p)$$

BAV99U

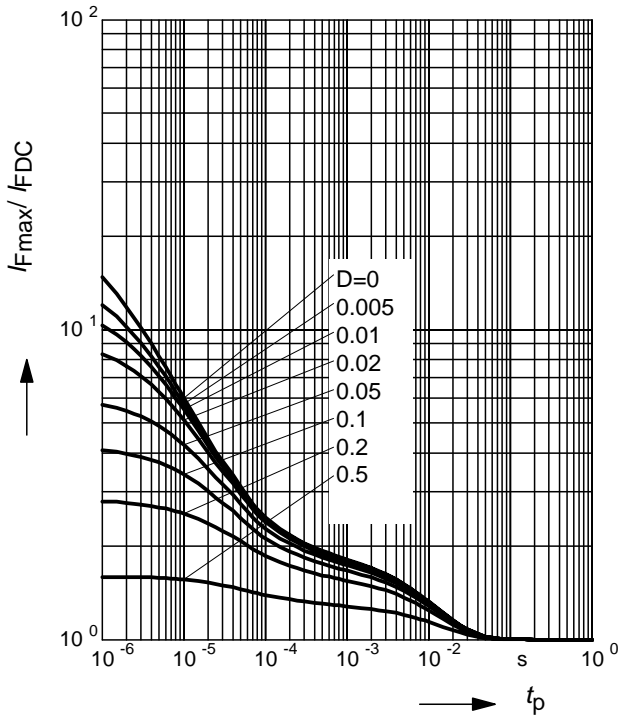

**Permissible Puls Load  $R_{thJS} = f(t_p)$**

BAV99W

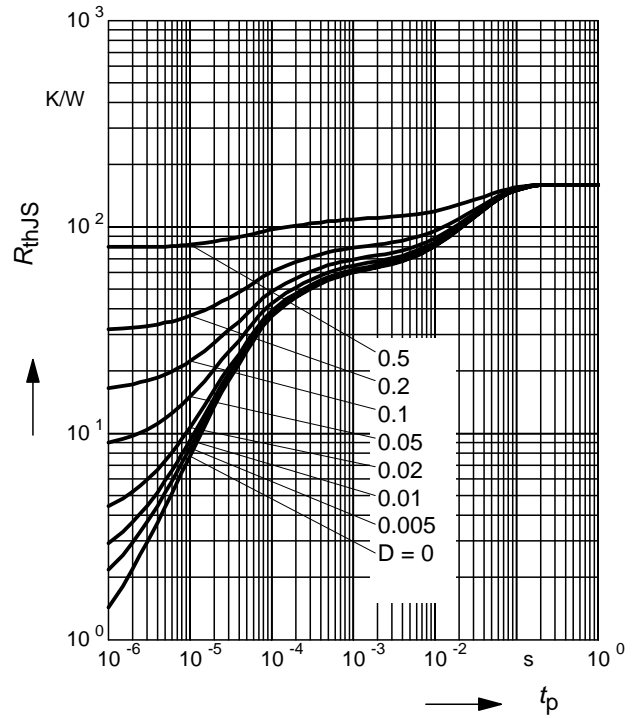

**Permissible Pulse Load**

$$I_{Fmax} / I_{FDC} = f(t_p)$$

BAV99W

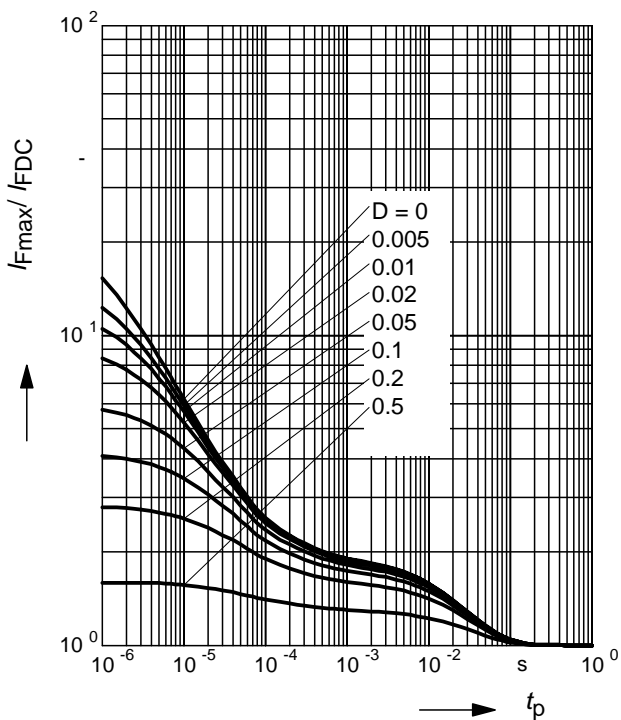

Package Outline



Foot Print



Marking Layout (Example)

Small variations in positioning of Date code, Type code and Manufacture are possible.



Standard Packing

Reel  $\varnothing$ 180 mm = 3.000 Pieces/Reel  
 Reel  $\varnothing$ 330 mm = 10.000 Pieces/Reel

For symmetric types no defined Pin 1 orientation in reel.



Package Outline



1) Lead width can be 0.6 max. in dambar area

Foot Print



Marking Layout (Example)

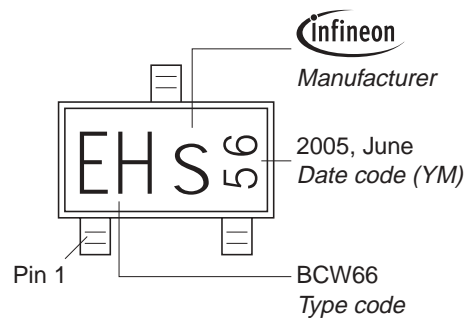

Standard Packing

Reel  $\varnothing$ 180 mm = 3.000 Pieces/Reel  
 Reel  $\varnothing$ 330 mm = 10.000 Pieces/Reel

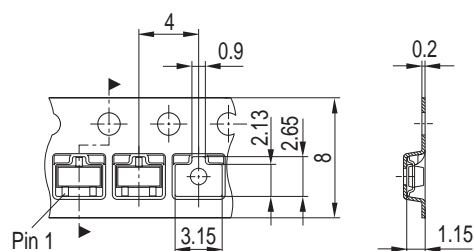

Package Outline



Foot Print



Marking Layout (Example)



Standard Packing

Reel ø180 mm = 3.000 Pieces/Reel  
 Reel ø330 mm = 10.000 Pieces/Reel

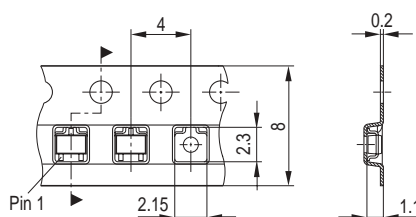

Package Outline

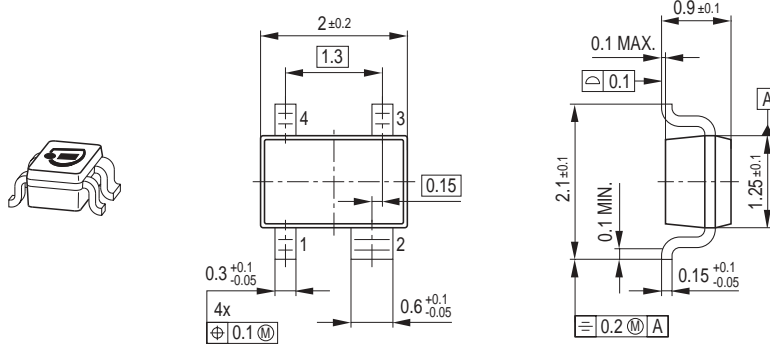

Foot Print

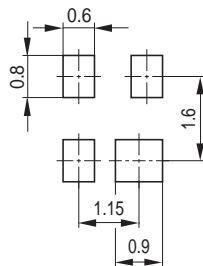

Marking Layout (Example)

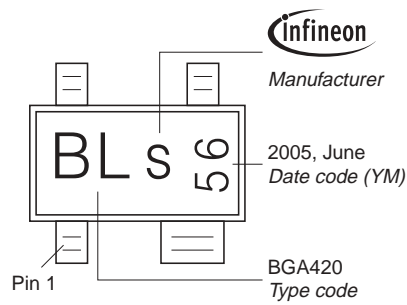

Standard Packing

Reel ø180 mm = 3.000 Pieces/Reel  
 Reel ø330 mm = 10.000 Pieces/Reel

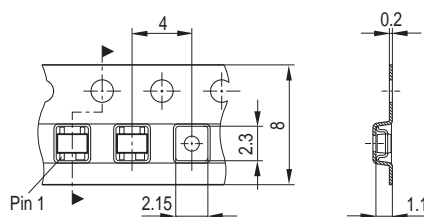

### Package Outline

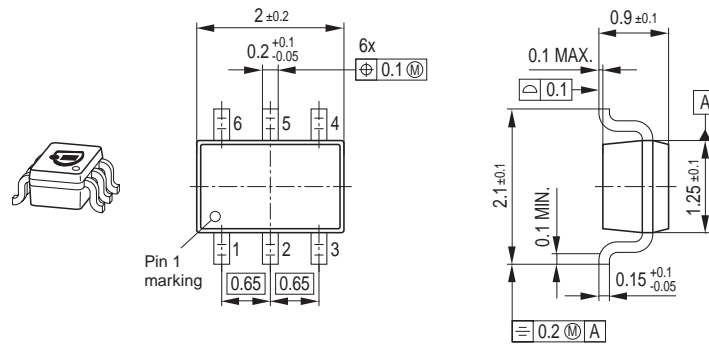

### Foot Print

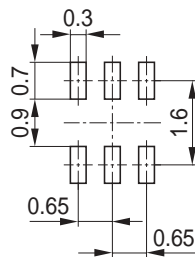

### Marking Layout (Example)

Small variations in positioning of Date code, Type code and Manufacture are possible.

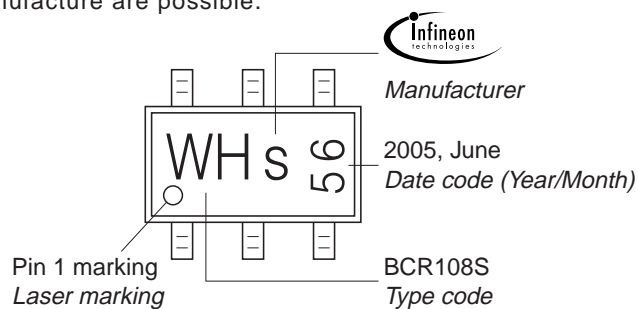

### Standard Packing

Reel  $\varnothing$ 180 mm = 3.000 Pieces/Reel  
 Reel  $\varnothing$ 330 mm = 10.000 Pieces/Reel

For symmetric types no defined Pin 1 orientation in reel.

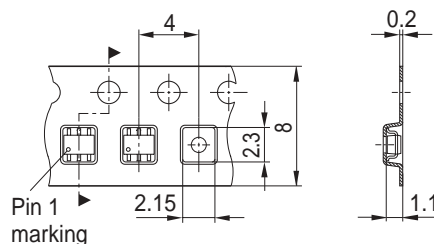

Edition 2006-02-01  
Published by  
Infineon Technologies AG  
81726 München, Germany  
© Infineon Technologies AG 2007.  
All Rights Reserved.

### **Attention please!**

The information given in this dokument shall in no event be regarded as a guarantee of conditions or characteristics ("Beschaffenheitsgarantie"). With respect to any examples or hints given herein, any typical values stated herein and/or any information regarding the application of the device, Infineon Technologies hereby disclaims any and all warranties and liabilities of any kind, including without limitation warranties of non-infringement of intellectual property rights of any third party.

### **Information**

For further information on technology, delivery terms and conditions and prices please contact your nearest Infineon Technologies Office ([www.infineon.com](http://www.infineon.com)).

### **Warnings**



Due to technical requirements components may contain dangerous substances. For information on the types in question please contact your nearest Infineon Technologies Office.

Infineon Technologies Components may only be used in life-support devices or systems with the express written approval of Infineon Technologies, if a failure of such components can reasonably be expected to cause the failure of that life-support device or system, or to affect the safety or effectiveness of that device or system.

Life support devices or systems are intended to be implanted in the human body, or to support and/or maintain and sustain and/or protect human life. If they fail, it is reasonable to assume that the health of the user or other persons may be endangered.

## Looking for pricing, stock, or lifecycle information?

Click below to explore more details on WIN SOURCE:

-  [View BCR191 on WIN SOURCE](#)
-  [Infineon Technologies Information](#)

## Optimize Your Supply Chain with WIN SOURCE Solutions

-  Global Sourcing Solution
-  Obsolete Management
-  Cost Control Management
-  Shortage Management
-  Alternative Solution
-  Excess Inventory Management