



**THE DATASHEET OF  
1N4003RLG**



# Axial-Lead Glass Passivated Standard Recovery Rectifiers

**1N4001, 1N4002, 1N4003,  
 1N4004, 1N4005, 1N4006,  
 1N4007**

This data sheet provides information on subminiature size, axial lead mounted rectifiers for general-purpose low-power applications.

### Features

- Shipped in Plastic Bags, 1000 per bag
- Available Tape and Reeled, 5000 per reel, by adding a “RL” suffix to the part number
- Available in Fan-Fold Packaging, 3000 per box, by adding a “FF” suffix to the part number
- Pb-Free Packages are Available

### Mechanical Characteristics

- Case: Epoxy, Molded
- Weight: 0.4 gram (approximately)
- Finish: All External Surfaces Corrosion Resistant and Terminal Leads are Readily Solderable
- Lead and Mounting Surface Temperature for Soldering Purposes: 260°C Max. for 10 Seconds, 1/16 in. from case
- Polarity: Cathode Indicated by Polarity Band

\*For additional information on our Pb-Free strategy and soldering details, please download the **onsemi** Soldering and Mounting Techniques Reference Manual, SOLDERRM/D.

## LEAD MOUNTED RECTIFIERS 50–1000 VOLTS DIFFUSED JUNCTION

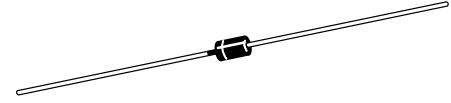

CASE 59–10  
 AXIAL LEAD  
 PLASTIC

### MARKING DIAGRAM



A = Assembly Location  
 1N400x = Device Number  
 x = 1, 2, 3, 4, 5, 6 or 7  
 YY = Year  
 WW = Work Week  
 ■ = Pb-Free Package  
 (Note: Microdot may be in either location)

### ORDERING INFORMATION

See detailed ordering and shipping information on page 5 of this data sheet.

# 1N4001, 1N4002, 1N4003, 1N4004, 1N4005, 1N4006, 1N4007

## MAXIMUM RATINGS

Rating	Symbol	1N4001	1N4002	1N4003	1N4004	1N4005	1N4006	1N4007	Unit
†Peak Repetitive Reverse Voltage Working Peak Reverse Voltage DC Blocking Voltage	$V_{RRM}$ $V_{RWM}$ $V_R$	50	100	200	400	600	800	1000	V
†Non-Repetitive Peak Reverse Voltage (halfwave, single phase, 60 Hz)	$V_{RSM}$	60	120	240	480	720	1000	1200	V
†RMS Reverse Voltage	$V_{R(RMS)}$	35	70	140	280	420	560	700	V
†Average Rectified Forward Current (single phase, resistive load, 60 Hz, $T_A = 75^\circ\text{C}$ )	$I_O$	1.0							A
†Non-Repetitive Peak Surge Current (surge applied at rated load conditions)	$I_{FSM}$	30 (for 1 cycle)							A
Operating and Storage Junction Temperature Range	$T_J$ $T_{stg}$	-65 to +150							$^\circ\text{C}$

Stresses exceeding those listed in the Maximum Ratings table may damage the device. If any of these limits are exceeded, device functionality should not be assumed, damage may occur and reliability may be affected.

†Indicates JEDEC Registered Data

## THERMAL CHARACTERISTICS

Rating	Symbol	Max	Unit
Maximum Thermal Resistance, Junction-to-Ambient	$R_{\theta JA}$	Note 1	$^\circ\text{C}/\text{W}$

## ELECTRICAL CHARACTERISTICS†

Rating	Symbol	Typ	Max	Unit
Maximum Instantaneous Forward Voltage Drop, ( $I_F = 1.0$ Amp, $T_J = 25^\circ\text{C}$ )	$V_F$	0.93	1.1	V
Maximum Full-Cycle Average Forward Voltage Drop, ( $I_O = 1.0$ Amp, $T_L = 75^\circ\text{C}$ , 1 inch leads)	$V_{F(AV)}$	-	0.8	V
Maximum Reverse Current (rated DC voltage) ( $T_J = 25^\circ\text{C}$ ) ( $T_J = 100^\circ\text{C}$ )	$I_R$	0.05 1.0	10 50	$\mu\text{A}$
Maximum Full-Cycle Average Reverse Current, ( $I_O = 1.0$ Amp, $T_L = 75^\circ\text{C}$ , 1 inch leads)	$I_{R(AV)}$	-	30	$\mu\text{A}$

Product parametric performance is indicated in the Electrical Characteristics for the listed test conditions, unless otherwise noted. Product performance may not be indicated by the Electrical Characteristics if operated under different conditions.

†Indicates JEDEC Registered Data

# 1N4001, 1N4002, 1N4003, 1N4004, 1N4005, 1N4006, 1N4007

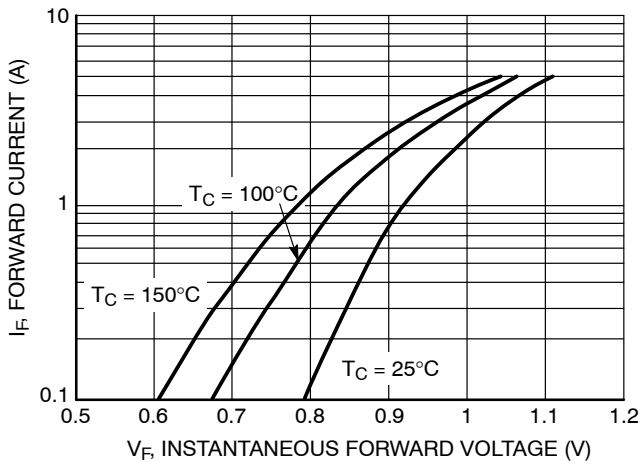

Figure 1. Typical Forward Voltage

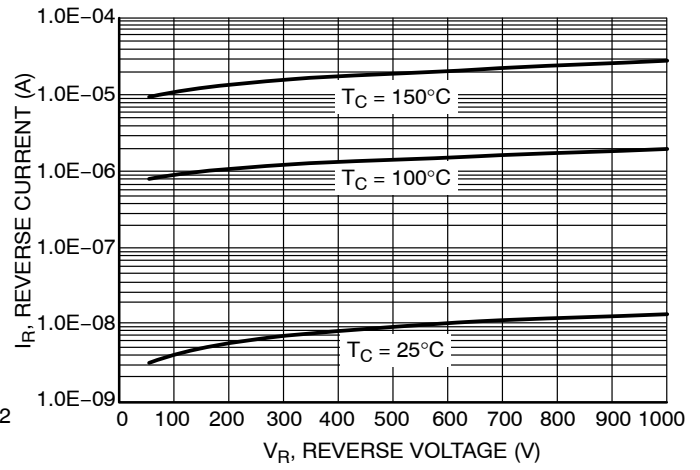

Figure 2. Typical Reverse Current

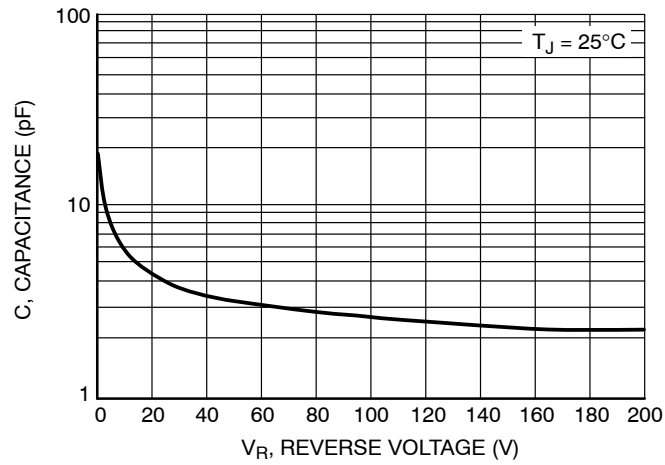

Figure 3. Typical Capacitance

NOTE 1. – AMBIENT MOUNTING DATA

Data shown for thermal resistance, junction-to-ambient ( $R_{\theta JA}$ ) for the mountings shown is to be used as typical guideline values for preliminary engineering or in case the tie point temperature cannot be measured.

TYPICAL VALUES FOR  $R_{\theta JA}$  IN STILL AIR

Mounting Method	$R_{\theta JA}$	Lead Length, L			Units
		1/8	1/4	1/2	
1		52	65	72	$^{\circ}\text{C}/\text{W}$
2		67	80	87	$^{\circ}\text{C}/\text{W}$
3		50			$^{\circ}\text{C}/\text{W}$

MOUNTING METHOD 1

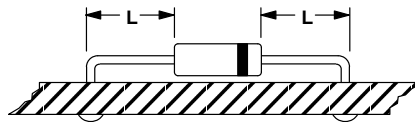

MOUNTING METHOD 2

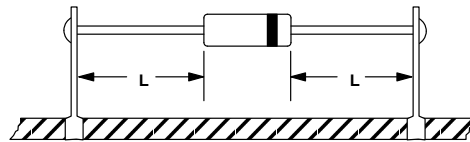

Vector Pin Mounting

MOUNTING METHOD 3

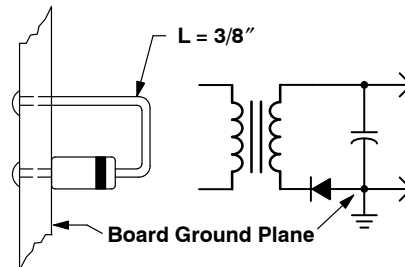

P.C. Board with  
1-1/2" X 1-1/2" Copper Surface

# 1N4001, 1N4002, 1N4003, 1N4004, 1N4005, 1N4006, 1N4007

## ORDERING INFORMATION

Device	Package	Shipping <sup>†</sup>
1N4001	Axial Lead*	1000 Units/Bag
1N4001G	Axial Lead* (Pb-Free)	1000 Units/Bag
1N4001RL	Axial Lead*	5000/Tape & Reel
1N4001RLG	Axial Lead* (Pb-Free)	5000/Tape & Reel
1N4002	Axial Lead*	1000 Units/Bag
1N4002G	Axial Lead* (Pb-Free)	1000 Units/Bag
1N4002RL	Axial Lead*	5000/Tape & Reel
1N4002RLG	Axial Lead* (Pb-Free)	5000/Tape & Reel
1N4003	Axial Lead*	1000 Units/Bag
1N4003G	Axial Lead* (Pb-Free)	1000 Units/Bag
1N4003RL	Axial Lead*	5000/Tape & Reel
1N4003RLG	Axial Lead* (Pb-Free)	5000/Tape & Reel
1N4004	Axial Lead*	1000 Units/Bag
1N4004G	Axial Lead* (Pb-Free)	1000 Units/Bag
1N4004RL	Axial Lead*	5000/Tape & Reel
1N4004RLG	Axial Lead* (Pb-Free)	5000/Tape & Reel
1N4005	Axial Lead*	1000 Units/Bag
1N4005G	Axial Lead* (Pb-Free)	1000 Units/Bag
1N4005RL	Axial Lead*	5000/Tape & Reel
1N4005RLG	Axial Lead* (Pb-Free)	5000/Tape & Reel
1N4006	Axial Lead*	1000 Units/Bag
1N4006G	Axial Lead* (Pb-Free)	1000 Units/Bag
1N4006FFG	Axial Lead* (Pb-Free)	3000 Units/Box
1N4006RL	Axial Lead*	5000/Tape & Reel
1N4006RLG	Axial Lead* (Pb-Free)	5000/Tape & Reel
1N4007	Axial Lead*	1000 Units/Bag
1N4007G	Axial Lead* (Pb-Free)	1000 Units/Bag
1N4007FFG	Axial Lead* (Pb-Free)	3000 Units/Box
1N4007RL	Axial Lead*	5000/Tape & Reel
1N4007RLG	Axial Lead* (Pb-Free)	5000/Tape & Reel

<sup>†</sup>For information on tape and reel specifications, including part orientation and tape sizes, please refer to our Tape and Reel Packaging Specifications Brochure, BRD8011/D.

\*This package is inherently Pb-Free.

# MECHANICAL CASE OUTLINE

## PACKAGE DIMENSIONS

ON Semiconductor®



### AXIAL LEAD CASE 59-10 ISSUE U

DATE 15 FEB 2005

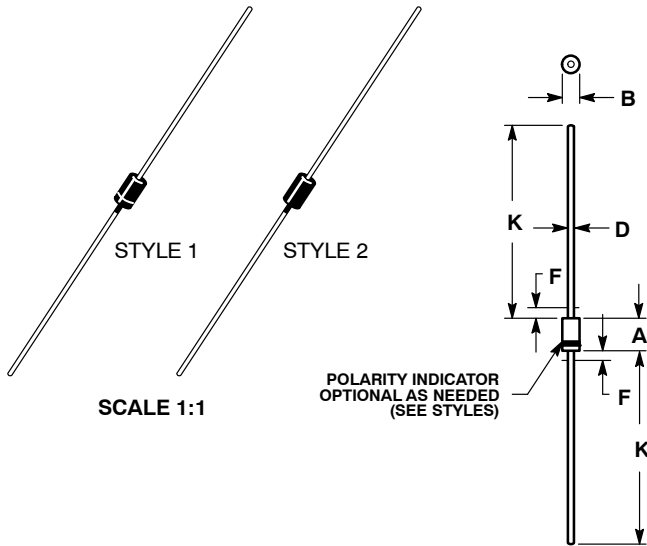

SCALE 1:1

POLARITY INDICATOR  
OPTIONAL AS NEEDED  
(SEE STYLES)

STYLE 1:  
PIN 1. CATHODE (POLARITY BAND)  
2. ANODE

STYLE 2:  
NO POLARITY

NOTES:

1. DIMENSIONING AND TOLERANCING PER ANSI Y14.5M, 1982.
2. CONTROLLING DIMENSION: INCH.
3. ALL RULES AND NOTES ASSOCIATED WITH JEDEC DO-41 OUTLINE SHALL APPLY
4. POLARITY DENOTED BY CATHODE BAND.
5. LEAD DIAMETER NOT CONTROLLED WITHIN F DIMENSION.

DIM	INCHES		MILLIMETERS	
	MIN	MAX	MIN	MAX
A	0.161	0.205	4.10	5.20
B	0.079	0.106	2.00	2.70
D	0.028	0.034	0.71	0.86
F	---	0.050	---	1.27
K	1.000	---	25.40	---

### GENERIC MARKING DIAGRAM\*

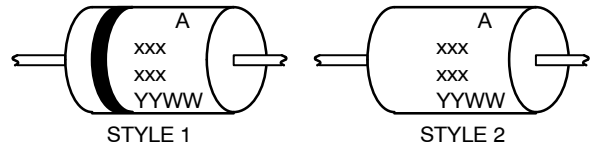

- xxx = Specific Device Code
- A = Assembly Location
- YY = Year
- WW = Work Week

\*This information is generic. Please refer to device data sheet for actual part marking. Pb-Free indicator, "G" or microdot "▪", may or may not be present.

<b>DOCUMENT NUMBER:</b>	<b>98ASB42045B</b>	Electronic versions are uncontrolled except when accessed directly from the Document Repository. Printed versions are uncontrolled except when stamped "CONTROLLED COPY" in red.
<b>DESCRIPTION:</b>	<b>AXIAL LEAD</b>	<b>PAGE 1 OF 1</b>

ON Semiconductor and are trademarks of Semiconductor Components Industries, LLC dba ON Semiconductor or its subsidiaries in the United States and/or other countries. ON Semiconductor reserves the right to make changes without further notice to any products herein. ON Semiconductor makes no warranty, representation or guarantee regarding the suitability of its products for any particular purpose, nor does ON Semiconductor assume any liability arising out of the application or use of any product or circuit, and specifically disclaims any and all liability, including without limitation special, consequential or incidental damages. ON Semiconductor does not convey any license under its patent rights nor the rights of others.

**onsemi**, **Onsemi**, and other names, marks, and brands are registered and/or common law trademarks of Semiconductor Components Industries, LLC dba "**onsemi**" or its affiliates and/or subsidiaries in the United States and/or other countries. **onsemi** owns the rights to a number of patents, trademarks, copyrights, trade secrets, and other intellectual property. A listing of **onsemi**'s product/patent coverage may be accessed at [www.onsemi.com/site/pdf/Patent-Marking.pdf](http://www.onsemi.com/site/pdf/Patent-Marking.pdf). **onsemi** reserves the right to make changes at any time to any products or information herein, without notice. The information herein is provided "as-is" and **onsemi** makes no warranty, representation or guarantee regarding the accuracy of the information, product features, availability, functionality, or suitability of its products for any particular purpose, nor does **onsemi** assume any liability arising out of the application or use of any product or circuit, and specifically disclaims any and all liability, including without limitation special, consequential or incidental damages. Buyer is responsible for its products and applications using **onsemi** products, including compliance with all laws, regulations and safety requirements or standards, regardless of any support or applications information provided by **onsemi**. "Typical" parameters which may be provided in **onsemi** data sheets and/or specifications can and do vary in different applications and actual performance may vary over time. All operating parameters, including "Typicals" must be validated for each customer application by customer's technical experts. **onsemi** does not convey any license under any of its intellectual property rights nor the rights of others. **onsemi** products are not designed, intended, or authorized for use as a critical component in life support systems or any FDA Class 3 medical devices or medical devices with a same or similar classification in a foreign jurisdiction or any devices intended for implantation in the human body. Should Buyer purchase or use **onsemi** products for any such unintended or unauthorized application, Buyer shall indemnify and hold **onsemi** and its officers, employees, subsidiaries, affiliates, and distributors harmless against all claims, costs, damages, and expenses, and reasonable attorney fees arising out of, directly or indirectly, any claim of personal injury or death associated with such unintended or unauthorized use, even if such claim alleges that **onsemi** was negligent regarding the design or manufacture of the part. **onsemi** is an Equal Opportunity/Affirmative Action Employer. This literature is subject to all applicable copyright laws and is not for resale in any manner.

---

## ADDITIONAL INFORMATION

### TECHNICAL PUBLICATIONS:



Technical Library: [www.onsemi.com/design/resources/technical-documentation](http://www.onsemi.com/design/resources/technical-documentation)  
onsemi Website: [www.onsemi.com](http://www.onsemi.com)

### ONLINE SUPPORT: [www.onsemi.com/support](http://www.onsemi.com/support)

For additional information, please contact your local Sales Representative at [www.onsemi.com/support/sales](http://www.onsemi.com/support/sales)

## Looking for pricing, stock, or lifecycle information?

Click below to explore more details on WIN SOURCE:

-  [View 1N4003RLG on WIN SOURCE](#)
-  [ON Semiconductor](#) Information

## Optimize Your Supply Chain with WIN SOURCE Solutions

-  Global Sourcing Solution
-  Obsolete Management
-  Cost Control Management
-  Shortage Management
-  Alternative Solution
-  Excess Inventory Management