



THE DATASHEET OF
100314QI



100314

Low Power Quint Differential Line Receiver

General Description

The 100314 is a monolithic quint differential line receiver with emitter-follower outputs. An internal reference supply (V_{BB}) is available for single-ended reception. When used in single-ended operation the apparent input threshold of the true inputs is 25 mV to 30 mV higher (positive) than the threshold of the complementary inputs. Unlike other F100K ECL devices, the inputs do not have input pull-down resistors.

Active current sources provide common-mode rejection of 1.0V in either the positive or negative direction. A defined output state exists if both inverting and non-inverting inputs are at the same potential between V_{EE} and V_{CC} . The defined state is logic HIGH on the \bar{O}_a - \bar{O}_e outputs.

Features

- 35% power reduction of the 100114
- 2000V ESD protection
- Pin/function compatible with 100114
- Voltage compensated operating range = -4.2V to -5.7V
- Available to industrial grade temperature range (PLCC package only)

Ordering Code:

Order Number	Package Number	Package Description
100314SC	M24B	24-Lead Small Outline Integrated Circuit (SOIC), JEDEC MS-013, 0.300 Wide
100314PC	N24E	24-Lead Plastic Dual-In-Line Package (PDIP), JEDEC MS-010, 0.400 Wide
100314QC	V28A	28-Lead Plastic Lead Chip Carrier (PLCC), JEDEC MO-047, 0.450 Square
100314QI	V28A	28-Lead Plastic Lead Chip Carrier (PLCC), JEDEC MO-047, 0.450 Square Industrial Temperature Range (-40°C to +85°C)

Devices also available in Tape and Reel. Specify by appending the suffix letter "X" to the ordering code.

Logic Symbol

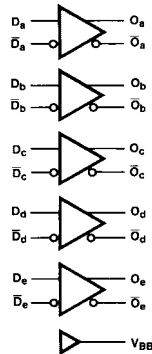

Connection Diagrams

24-Pin DIP/SOIC

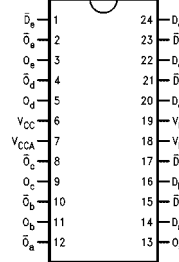

28-Pin PLCC

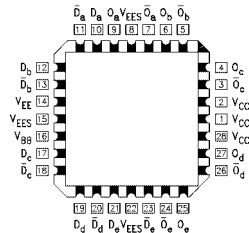

Pin Descriptions

Pin Names	Description
D_a - D_e	Data Inputs
\bar{D}_a - \bar{D}_e	Inverting Data Inputs
O_a - O_e	Data Outputs
\bar{O}_a - \bar{O}_e	Complementary Data Outputs

Absolute Maximum Ratings (Note 1)

Storage Temperature (T_{STG})	-65°C to +150°C
Maximum Junction Temperature (T_J)	+150°C
Pin Potential to Ground Pin (V_{EE})	-7.0V to +0.5V
Input Voltage (DC)	V_{EE} to +0.5V
Output Current (DC Output HIGH)	-50 mA
ESD (Note 2)	$\geq 2000V$

Recommended Operating Conditions

Case Temperature (T_C)	Commercial	0°C to +85°C
	Industrial	-40°C to +85°C
Supply Voltage (V_{EE})		-5.7V to -4.2V

Note 1: The "Absolute Maximum Ratings" are those values beyond which the safety of the device cannot be guaranteed. The device should not be operated at these limits. The parametric values defined in the Electrical Characteristics tables are not guaranteed at the absolute maximum rating. The "Recommended Operating Conditions" table will define the conditions for actual device operation.

Note 2: ESD testing conforms to MIL-STD-883, Method 3015.

Commercial Version**DC Electrical Characteristics** (Note 3)

$V_{EE} = -4.2V$ to $-5.7V$, $V_{CC} = V_{CCA} = GND$, $T_C = 0^\circ C$ to $+85^\circ C$

Symbol	Parameter	Min	Typ	Max	Units	Conditions
V_{OH}	Output HIGH Voltage	-1025	-955	-870	mV	$V_{IN} = V_{IH} (Max)$ Loading with 50Ω to $-2.0V$
V_{OL}	Output LOW Voltage	-1830	-1705	-1620	mV	or $V_{IL} (Min)$
V_{OHC}	Output HIGH Voltage	-1035			mV	$V_{IN} = V_{IH}$ Loading with 50Ω to $-2.0V$
V_{OLC}	Output LOW Voltage			-1610	mV	or $V_{IL} (Max)$
V_{BB}	Output Reference Voltage	-1380	-1320	-1260	mV	$I_{V_{BB}} = -250 \mu A$
V_{DIFF}	Input Voltage Differential	150			mV	Required for Full Output Swing
V_{CM}	Common Mode Voltage	$V_{CC} - 2.0$		$V_{CC} - 0.5$	V	
V_{IH}	Single-Ended Input HIGH Voltage	-1110		-870	mV	Guaranteed HIGH Signal for All Inputs (with one input tied to V_{BB}) $V_{BB} (Max) + V_{DIFF}$
V_{IL}	Single-Ended Input LOW Voltage	-1830		-1530	mV	Guaranteed LOW Signal for All Inputs (with one input tied to V_{BB}) $V_{BB} (Min) - V_{DIFF}$
I_{IL}	Input LOW Current	0.50			μA	$V_{IN} = V_{IL} (Min)$
I_{IH}	Input HIGH Current			240	μA	$V_{IN} = V_{IH} (Max)$, $D_a - D_e = V_{BB}$, $\overline{D}_a - \overline{D}_e = V_{IL} (Min)$
I_{CBO}	Input Leakage Current	-10			μA	$V_{IN} = V_{EE}$, $D_a - D_e = V_{BB}$, $\overline{D}_a - \overline{D}_e = V_{IL} (Min)$
I_{EE}	Power Supply Current	-60		-30	mA	$D_a - D_e = V_{BB}$, $\overline{D}_a - \overline{D}_e = V_{IL} (Min)$

Note 3: The specified limits represent the "worst case" value for the parameter. Since these values normally occur at the temperature extremes, additional noise immunity and guardbanding can be achieved by decreasing the allowable system operating ranges. Conditions for testing shown in the tables are chosen to guarantee operation under "worst case" conditions.

Commercial Version (Continued) DIP AC Electrical Characteristics

 $V_{EE} = -4.2V$ to $-5.7V$, $V_{CC} = V_{CCA} = GND$

Symbol	Parameter	$T_C = 0^\circ C$		$T_C = +25^\circ C$		$T_C = +85^\circ C$		Units	Conditions
		Min	Max	Min	Max	Min	Max		
f_{MAXFS}	Toggle Frequency (Full Swing)	250		250		250		MHz	(Note 2)
f_{MAXRS}	Toggle Frequency (Reduced Swing)	700		700		700		MHz	(Note 3)
t_{PLH} t_{PHL}	Propagation Delay Data to Output	0.65	1.90	0.65	2.00	0.70	2.00	ns	Figures 1, 2
t_{TLH} t_{THL}	Transition Time 20% to 80%, 80% to 20%	0.35	1.20	0.35	1.20	0.35	1.20	ns	

SOIC and PLCC AC Electrical Characteristics

 $V_{EE} = -4.2V$ to $-5.7V$, $V_{CC} = V_{CCA} = GND$

Symbol	Parameter	$T_C = 0^\circ C$		$T_C = +25^\circ C$		$T_C = +85^\circ C$		Units	Conditions
		Min	Max	Min	Max	Min	Max		
f_{MAXFS}	Toggle Frequency (Full Swing)	250		250		250		MHz	(Note 4)
f_{MAXRS}	Toggle Frequency (Reduced Swing)	700		700		700		MHz	(Note 5)
t_{PLH} t_{PHL}	Propagation Delay Data to Output	0.65	1.70	0.65	1.80	0.70	1.80	ns	Figures 1, 2
t_{TLH} t_{THL}	Transition Time 20% to 80%, 80% to 20%	0.35	1.10	0.35	1.10	0.35	1.10	ns	
t_{PLH} t_{PHL}	Propagation Delay Data to Output	0.70	1.50	0.80	1.60	0.90	1.80	ns	
t_{OSHL}	Maximum Skew Common Edge Output-to-Output Variation Data to Output Path		280		280		280	ps	PLCC only (Note 6)(Note 7)
t_{OSLH}	Maximum Skew Common Edge Output-to-Output Variation Data to Output Path		330		330		330	ps	PLCC only (Note 6)(Note 7)
t_{OST}	Maximum Skew Opposite Edge Output-to-Output Variation Data to Output Path		330		330		330	ps	PLCC only (Note 6)(Note 7)
t_{PS}	Maximum Skew Pin (Signal) Transition Variation Data to Output Path		320		320		320	ps	PLCC only (Note 6)(Note 7)

Note 4: Maximum toggle frequency at which V_{OH} and V_{OL} DC specifications are maintained.

Note 5: Maximum toggle frequency at which outputs maintain 150 mV swing.

Note 6: Output-to-Output Skew is defined as the absolute value of the difference between the actual propagation delay for any outputs within the same packaged device. The specifications apply to any outputs switching in the same direction either HIGH-to-LOW (t_{OSHL}), or LOW-to-HIGH (t_{OSLH}), or in opposite directions both HL and LH (t_{OST}). Parameters t_{OST} and t_{PS} guaranteed by design.

Note 7: All skews calculated using input crossing point to output crossing point propagation delays.

Industrial Version

PLCC DC Electrical Characteristics (Note 8)

$V_{EE} = -4.2V$ to $-5.7V$, $V_{CC} = V_{CCA} = GND$, $T_C = -40^\circ C$ to $+85^\circ C$

Symbol	Parameter	$T_C = -40^\circ C$		$T_C = 0^\circ C$ to $+85^\circ C$		Units	Conditions
		Min	Max	Min	Max		
V_{OH}	Output HIGH Voltage	-1085	-870	-1025	-870	mV	$V_{IN} = V_{IH} (Max)$ Loading with 50Ω to $-2.0V$
V_{OL}	Output LOW Voltage	-1830	-1575	-1830	-1620	mV	or $V_{IL} (Min)$
V_{OHC}	Output HIGH Voltage	-1095		-1035		mV	$V_{IN} = V_{IH}$ Loading with 50Ω to $-2.0V$
V_{OLC}	Output LOW Voltage		-1565		-1610	mV	or $V_{IL} (Min)$
V_{BB}	Output Reference Voltage	-1395	-1255	-1380	-1260	mV	$I_{VBB} = -250 \mu A$
V_{DIFF}	Input Voltage Differential	150		150		mV	Required for Full Output Swing
V_{CM}	Common Mode Voltage	$V_{CC} - 2.0$	$V_{CC} - 0.5$	$V_{CC} - 2.0$	$V_{CC} - 0.5$	V	
V_{IH}	Single-Ended Input HIGH Voltage	-1115	-870	-1110	-870	mV	Guaranteed HIGH Signal for All Inputs (with one input tied to V_{BB}) $V_{BB} (Max) + V_{DIFF}$
V_{IL}	Single-Ended Input LOW Voltage	-1830	-1535	-1830	-1530	mV	Guaranteed LOW Signal for All Inputs (with one input tied to V_{BB}) $V_{BB} (Min) - V_{DIFF}$
I_{IL}	Input LOW Current	0.50		0.50		μA	$V_{IN} = V_{IL} (Min)$
I_{IH}	Input HIGH Current		240		240	μA	$V_{IN} = V_{IH} (Max)$, $D_a - \bar{D}_e = V_{BB}$, $\bar{D}_a - D_e = V_{IL} (Min)$
I_{CBO}	Input Leakage Current	-10		-10		μA	$V_{IN} = V_{EE}$, $D_a - \bar{D}_e = V_{BB}$ $\bar{D}_a - D_e = V_{IL} (Min)$
I_{EE}	Power Supply Current	-60	-30	-60	-30	mA	$D_a - \bar{D}_e = V_{BB}$, $\bar{D}_a - D_e = V_{IL} (Min)$

Note 8: The specified limits represent the "worst case" value for the parameter. Since these values normally occur at the temperature extremes, additional noise immunity and guardbanding can be achieved by decreasing the allowable system operating ranges. Conditions for testing shown in the tables are chosen to guarantee operation under "worst case" conditions.

PLCC AC Electrical Characteristics

$V_{EE} = -4.2V$ to $-5.7V$, $V_{CC} = V_{CCA} = GND$

Symbol	Parameter	$T_C = -40^\circ C$		$T_C = +25^\circ C$		$T_C = +85^\circ C$		Units	Conditions
		Min	Max	Min	Max	Min	Max		
f_{MAXFS}	Toggle Frequency (Full Swing)	250		250		250		MHz	(Note 9)
f_{MAXRS}	Toggle Frequency (Reduced Swing)	700		700		700		MHz	(Note 10)
t_{PLH}	Propagation Delay Data to Output	0.65	1.70	0.65	1.80	0.70	1.80	ns	Figures 1, 2
t_{TLH}	Transition Time 20% to 80%, 80% to 20%	0.20	1.40	0.35	1.10	0.35	1.10	ns	

Note 9: Maximum toggle frequency at which V_{OH} and V_{OL} DC specifications are maintained.

Note 10: Maximum toggle frequency at which outputs maintain 150 mV swing.

Test Circuit

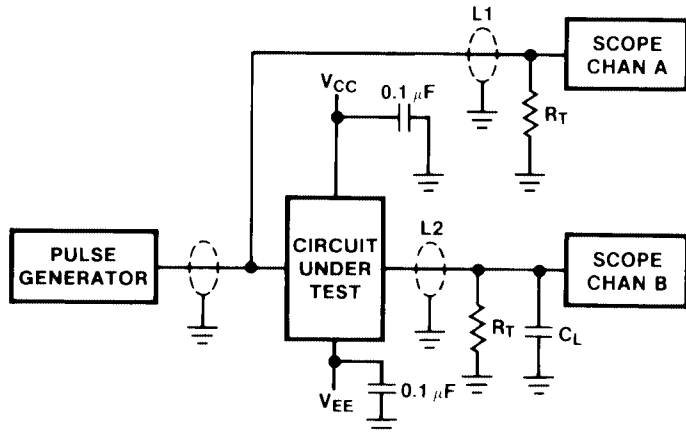

- Note:**
- $V_{CC}, V_{CCA} = +2V, V_{EE} = -2.5V$
 - L1 and L2 = equal length 50Ω impedance lines
 - $R_T = 50\Omega$ terminator internal to scope
 - Decoupling 0.1 μF from GND to V_{CC} and V_{EE}
 - All unused outputs are loaded with 50Ω to GND
 - C_L = Fixture and stray capacitance ≤ 3 pF

FIGURE 1. AC Test Circuit

Switching Waveforms

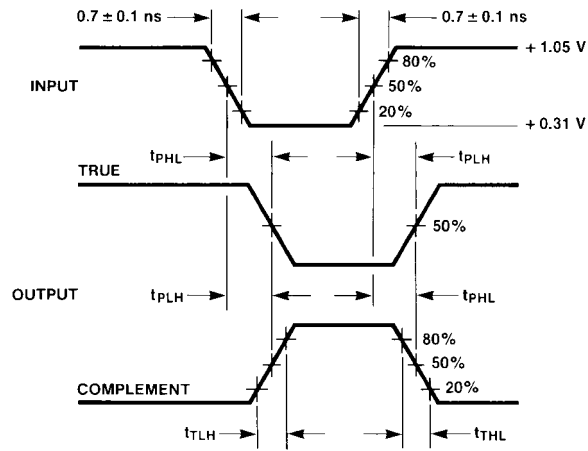
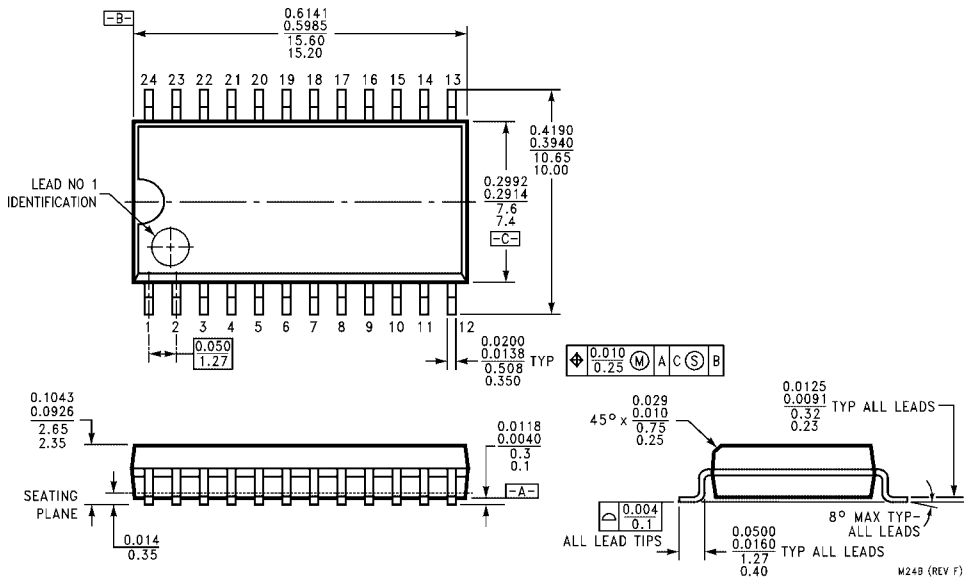
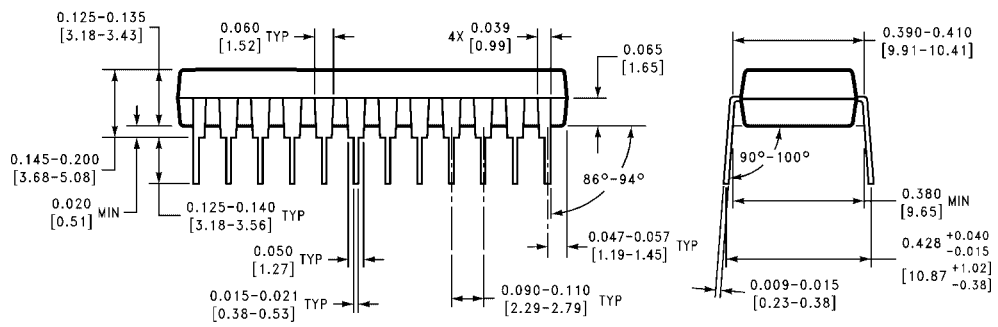
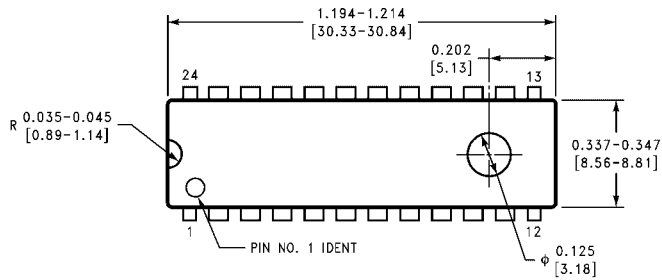

FIGURE 2. Propagation Delay and Transition Times

Physical Dimensions inches (millimeters) unless otherwise noted



**24-Lead Small Outline Integrated Circuit (SOIC), JEDEC MS-013, 0.300 Wide
Package Number M24B**



**24-Lead Plastic Dual-In-Line Package (PDIP), JEDEC MS-010, 0.400 Wide
Package Number N24E**

Physical Dimensions inches (millimeters) unless otherwise noted (Continued)

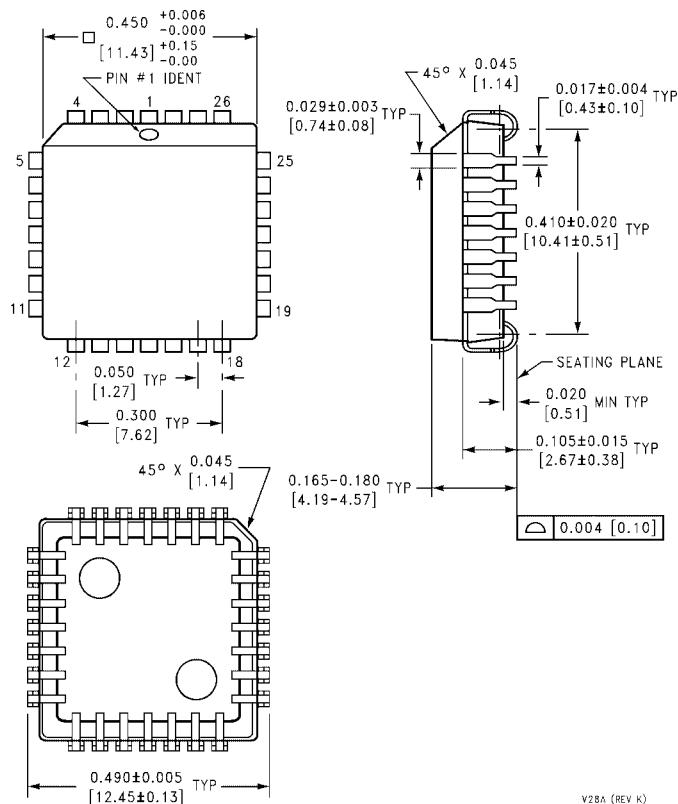

**28-Lead Plastic Lead Chip Carrier (PLCC), JEDEC MO-047, 0.450 Square
Package Number V28A**

Fairchild does not assume any responsibility for use of any circuitry described, no circuit patent licenses are implied and Fairchild reserves the right at any time without notice to change said circuitry and specifications.

LIFE SUPPORT POLICY



FAIRCHILD'S PRODUCTS ARE NOT AUTHORIZED FOR USE AS CRITICAL COMPONENTS IN LIFE SUPPORT DEVICES OR SYSTEMS WITHOUT THE EXPRESS WRITTEN APPROVAL OF THE PRESIDENT OF FAIRCHILD SEMICONDUCTOR CORPORATION. As used herein:

1. Life support devices or systems are devices or systems which, (a) are intended for surgical implant into the body, or (b) support or sustain life, and (c) whose failure to perform when properly used in accordance with instructions for use provided in the labeling, can be reasonably expected to result in a significant injury to the user.
2. A critical component in any component of a life support device or system whose failure to perform can be reasonably expected to cause the failure of the life support device or system, or to affect its safety or effectiveness.

www.fairchildsemi.com

Looking for pricing, stock, or lifecycle information?

Click below to explore more details on WIN SOURCE:

-  [View 100314QI on WIN SOURCE](#)
-  [ON Semiconductor Information](#)

Optimize Your Supply Chain with WIN SOURCE Solutions

-  Global Sourcing Solution
-  Obsolete Management
-  Cost Control Management
-  Shortage Management
-  Alternative Solution
-  Excess Inventory Management