



THE DATASHEET OF SSQC 7



Type SSQC & SSTC

2410 size SMD fuses, pre-assembled in SMD clips

HF **Pb** Conflict free metals

RoHS 6 Compliant

Features

- Surface mount, 2410 assembly
- Allows solderless field replacement of open fuse
- Available in rating of SSQC 250mA to 8A and SSTC 375mA to 7A
- Wide operating temperature range
- Tape & Reel for automatic placement
- RoHS 6 compliant (MSL = 1)
- Halogen Free
- Leadfree

Applications

- Notebook
- LCD monitor
- PC computer
- Office electronic equipment
- Industrial equipment
- Medical equipment
- POE, POE+
- LCD / LED monitor
- Power supply
- LCD / LED TV

LEAD FREE = **Pb**
HALOGEN FREE = **HF**



These fuse/clip assemblies can be efficiently placed in a single pass. Once reflowed, fuse replacement requires no resoldering.

Physical Specification

Materials

Clip Terminals : Matte Tin Plated Inconel Alloy

Electrical Specification

Maximum Recommended Fuse Current Rating 8Amperes, 125Volts.

Use of SSQ fuses rated higher than 8A, i.e. 10A, 12A, 15A may be suitable with proper evaluation. (Consult with bel engineering)

Environmental Specification

Shock Resistance	MIL-STD-202G, Method 213B, Test Condition 1 (100 G's peak for 6 milliseconds; Sawtooth waveform)
Vibration Resistance	MIL-STD-202G, Method 201A(10-55 Hz,0.06 inch, total excursion).
Salt Spray Resistance	MIL-STD-202G, Method 101E, Test Condition B(48 hrs).
Insulation Resistance	MIL-STD-202G, Method 302, Test Condition A (After Opening) 10,000 ohms minimum.
Solderability	MIL-STD-202G, Method 208H
Thermal Shock	MIL-STD-202G, Method 107G, Test Condition B (-65 °C to +125 °C).
Operating Temperature	-55 °C to +125 °C
Moisture Sensitivity Level	1 (According to IPC J-Std-020)

Specifications subject to change without notice



Bel Fuse Inc.
206 Van Vorst Street
Jersey City, NJ 07302 USA

+1 201.432.0463
techhelp@belf.com
belfuse.com

Type SSQC & SSTC

2410 size SMD fuses, pre-assembled in SMD clips

HF (Pb) Conflict free metals

RoHS 6 Compliant

Mechanical Dimensions

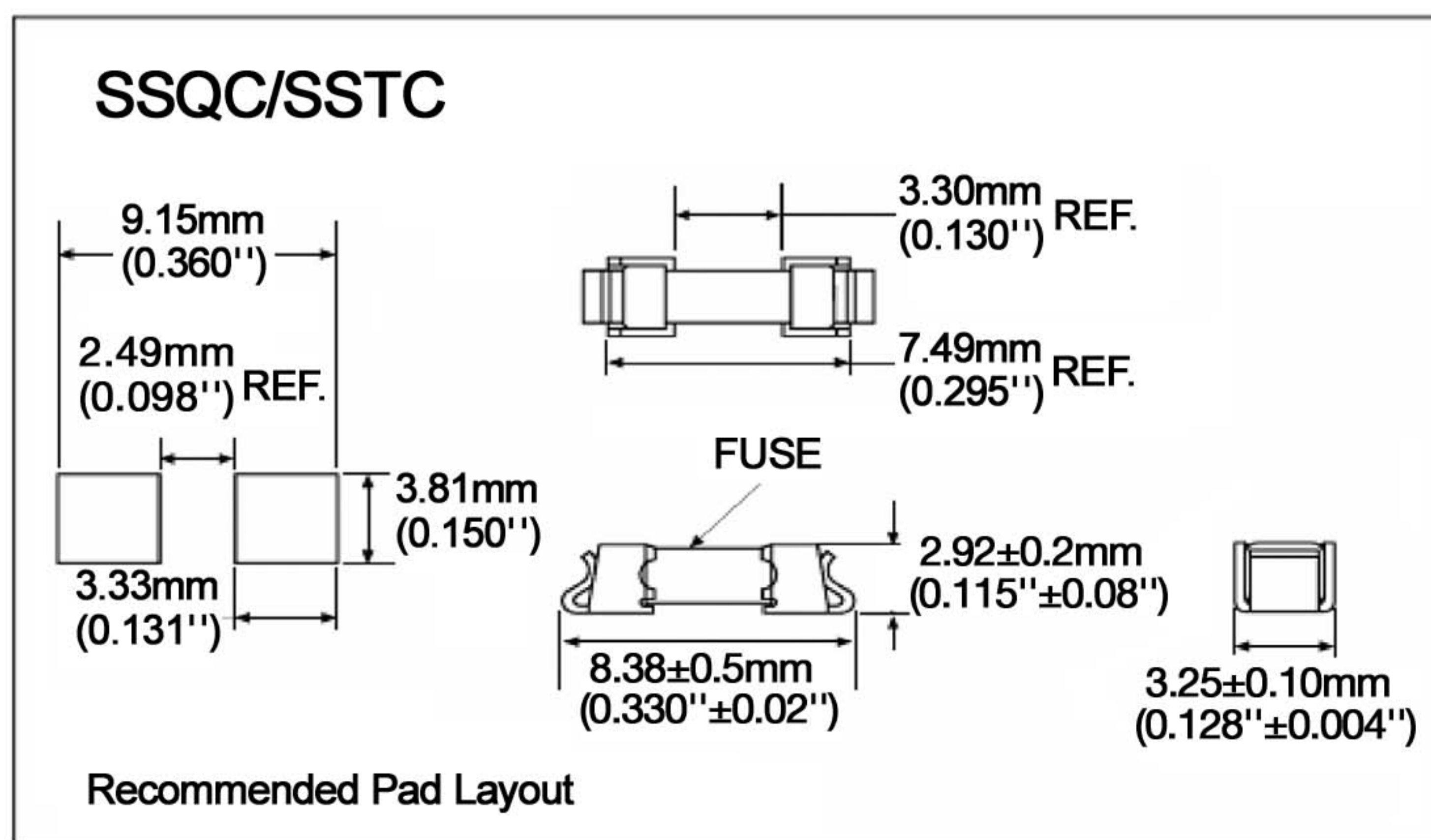

SSQ Square Ceramic Surface Mount Quick Action Fuse	
Catalog Number	Ampere Rating
SSQC 250	250mA
SSQC 375	375mA
SSQC 500	500mA
SSQC 750	750mA
SSQC 1	1A
SSQC 1.25	1.25A
SSQC 1.5	1.5A
SSQC 2	2A
SSQC 2.5	2.5A
SSQC 3	3A
SSQC 3.5	3.5A
SSQC 4	4A
SSQC 5	5A
SSQC 6.3	6.3A
SSQC 7	7A
SSQC 8	8A

SST Square Ceramic Surface Mount Slow Blow Fuse	
Catalog Number	Ampere Rating
SSTC 375	375mA
SSTC 500	500mA
SSTC 625	625mA
SSTC 750	750mA
SSTC 1	1A
SSTC1.5	1.5A
SSTC 2	2A
SSTC 2.5	2.5A
SSTC 3	3A
SSTC 3.5	3.5A
SSTC 3.75	3.75A
SSTC 4	4A
SSTC 5	5A
SSTC 6	6A
SSTC 6.3	6.3A
SSTC 7	7A

Consult manufacturer for other ratings

RoHS 6 Compliant Product

IR Reflow Profile (IPC/JEDEC J-STD-020D)	
Preheat & Soak	
Temperature min (T _{sm})	150 °C
Temperature max (T _{sm})	200 °C
Time (T _{sm} to T _{sm}) (t _s)	60 - 120 seconds
Average ramp-up rate (T _{sm} to T _p)	3 °C/second max.
Liquidous temperature (T _L)	217 °C
Time at liquidous (t _L)	60 - 150 seconds
Peak temperature (T _p)	260 °C max
Time (t _p) within 5 °C of the specified classification temperature (T _c)	30 seconds
Average ramp-down rate (T _p to T _{sm})	6 °C/second max.
Time 25 °C to peak temperature	8 minutes max.

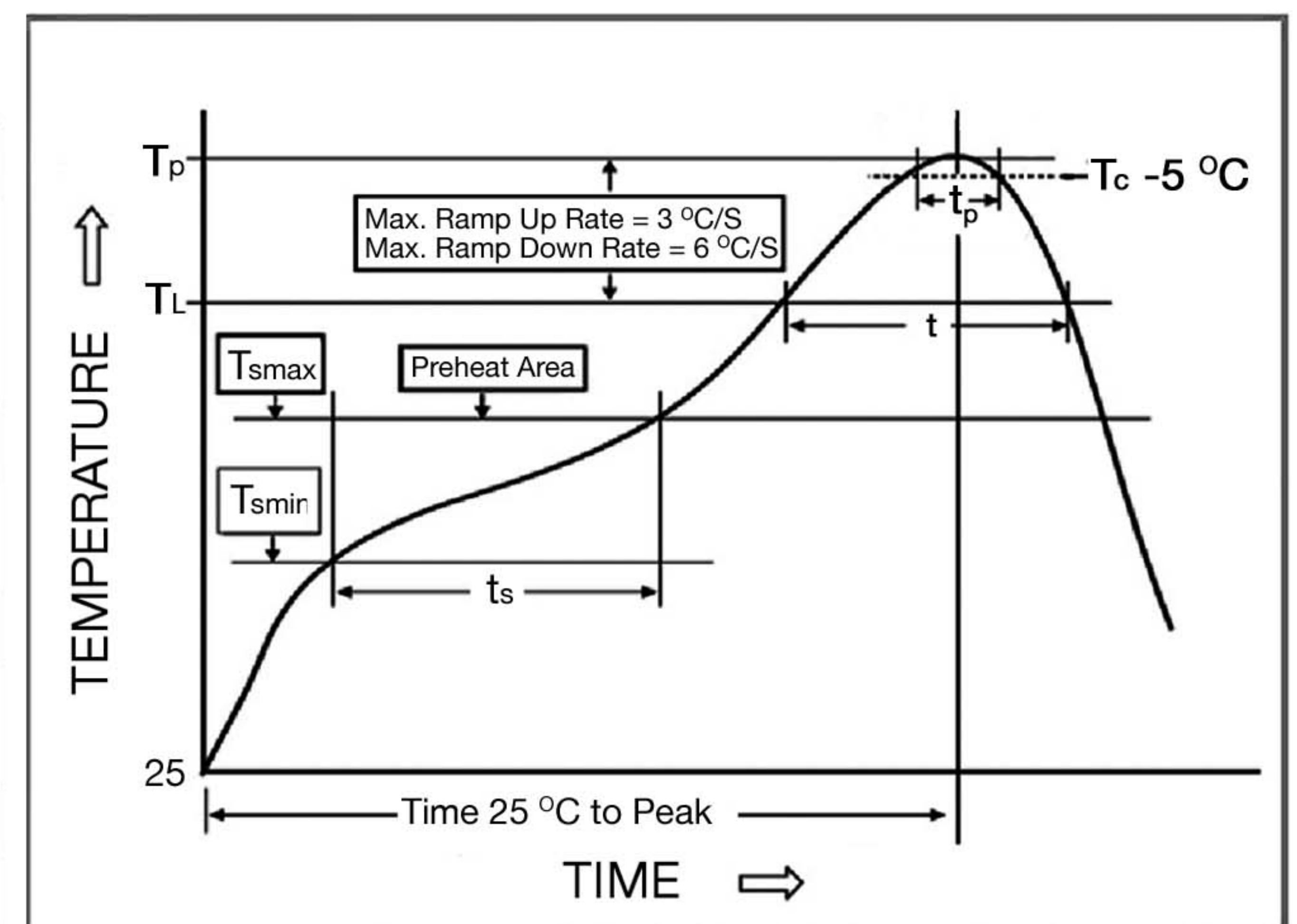

Packaging

Packaging Tape & Reel	Packaging Specification	Quantity	Part Number Code	Type
16mm wide tape, 8mm pitch with 7 inches Diameter reel	EIA Standard 481-E	500	0679-XXXX-12	SSQC
16mm wide tape, 8mm pitch with 7 inches Diameter reel	EIA Standard 481-E	500	0680-XXXX-12	SSTC

Specifications subject to change without notice



Bel Fuse Inc.
206 Van Vorst Street
Jersey City, NJ 07302 USA

+1 201.432.0463
techhelp@belf.com
belfuse.com

Looking for pricing, stock, or lifecycle information?

Click below to explore more details on WIN SOURCE:

[View SSQC 7 on WIN SOURCE](#)

[Bei Fuse Inc. Information](#)

Optimize Your Supply Chain with WIN SOURCE Solutions

- ✓ Global Sourcing Solution
- ✓ Obsolete Management
- ✓ Cost Control Management
- ✓ Shortage Management
- ✓ Alternative Solution
- ✓ Excess Inventory Management