



**THE DATASHEET OF**  
**046274033000894+**



0.5mm Pitch  
SERIES

# 6274

0.5mmピッチ ストレート SMT 片面接点 スライドロック  
0.5mmPitch Vertical SMT Single-sided contact Slide lock

標準タイプ  
Standard type

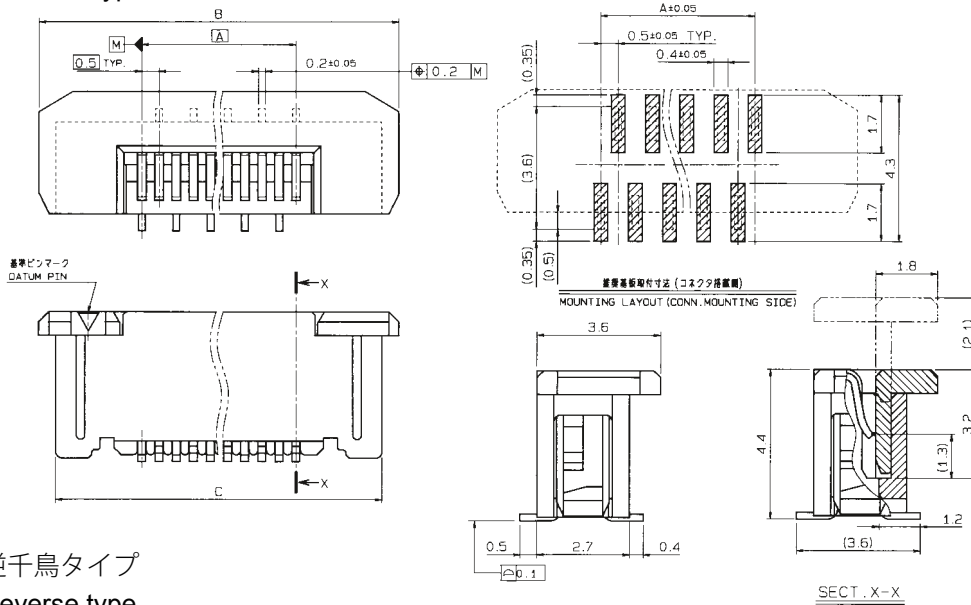

逆千鳥タイプ  
Reverse type

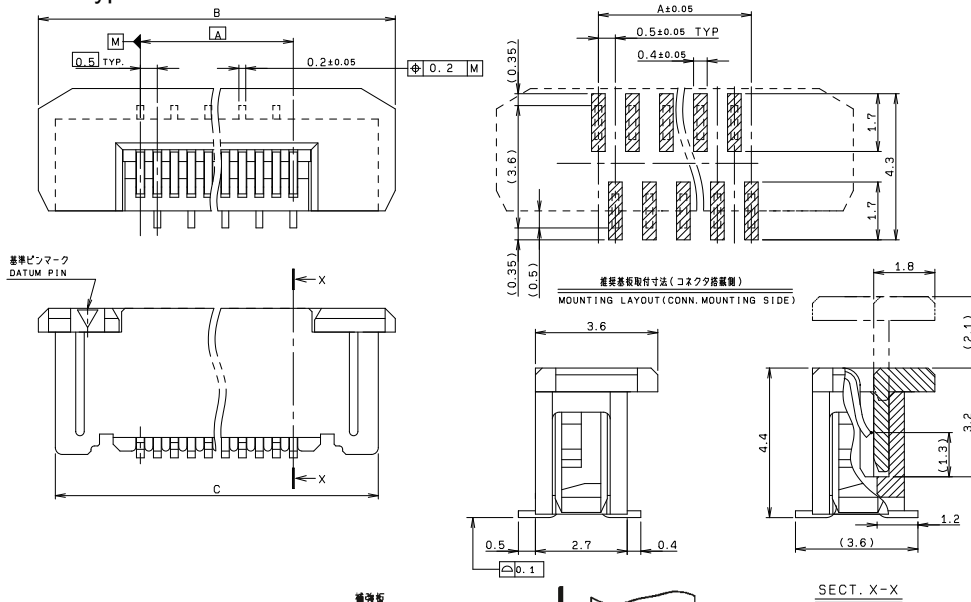

極数 NO. OF POS.	A	B	C
31	15.0	21.0	20.0
32	15.5	21.5	20.5
33	16.0	22.0	21.0
34	16.5	22.5	21.5
35	17.0	23.0	22.0
36	17.5	23.5	22.5
37	18.0	24.0	23.0
38	18.5	24.5	23.5
39	19.0	25.0	24.0
40	19.5	25.5	24.5
41	20.0	26.0	25.0
42	20.5	26.5	25.5
43	21.0	27.0	26.0
44	21.5	27.5	26.5
45	22.0	28.0	27.0
46	22.5	28.5	27.5
47	23.0	29.0	28.0
48	23.5	29.5	28.5
49	24.0	30.0	29.0
50	24.5	30.5	29.5

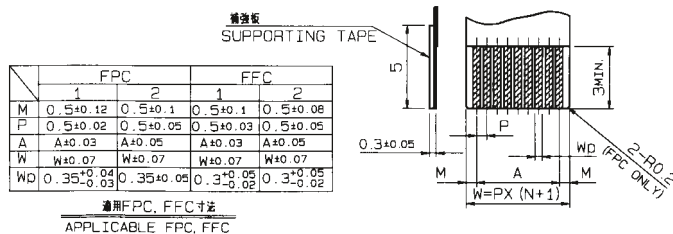

注文コード ORDERING CODE  
04 6274 0XX X00 XXX+

RoHS 対応品  
RoHS Compliant Product

極数 NUMBER OF  
POSITIONS

0: 標準タイプ Standard type  
1: 逆千鳥タイプ Reverse type

800+: スズ銅めっき Sn-Cu Plated  
894+: 金めっき Au Plated

生産対応可能極数については、営業部に  
ご確認ください。

Feel free to contact our sales department  
for available numbers of positions.

0.5mm Pitch  
SERIES

# 6274

エンボス梱包品  
Tape and Reel Package

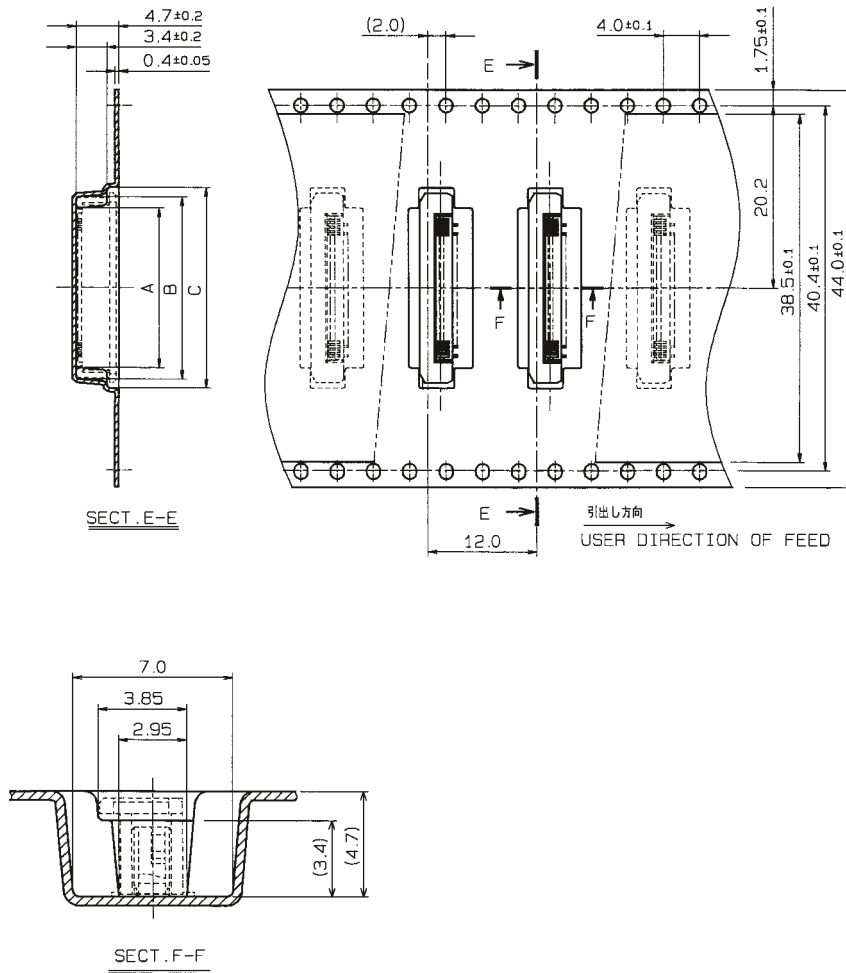

寸法表 DIMENSION			
極数 NO. OF POS.	A	B	C
31	17.7	20.2	22.2
32	18.2	20.7	22.7
33	18.7	21.2	23.2
34	19.2	21.7	23.7
35	19.7	22.2	24.2
36	20.2	22.7	24.7
37	20.7	23.2	25.2
38	21.2	23.7	25.7
39	21.7	24.2	26.2
40	22.2	24.7	26.7
41	22.7	25.2	27.2
42	23.2	25.7	27.7
43	23.7	26.2	28.2
44	24.2	26.7	28.7
45	24.7	27.2	29.2
46	25.2	27.7	29.7
47	25.7	28.2	30.2
48	26.2	28.7	30.7
49	26.7	29.2	31.2
50	27.2	29.7	31.7

注文コード ORDERING CODE

04 6274 0XX X00 XXX+

RoHS 対応品

RoHS Compliant Product

800+ : スズ銅めっき Sn-Cu Plated

894+ : 金めっき Au Plated

0 : 標準タイプ Standard type

1 : 逆千鳥タイプ Reverse type

極数 NUMBER OF POSITIONS

生産対応可能極数については、営業部にご確認願います。

Feel free to contact our sales department for available numbers of positions.

梱包数量 1000個/リール

PACKING QUANTITY 1000/Reel





## Looking for pricing, stock, or lifecycle information?

Click below to explore more details on WIN SOURCE:

 [View 046274033000894+ on WIN SOURCE](#)

 [AVX Corp/Kyocera Corp](#) Information

## Optimize Your Supply Chain with WIN SOURCE Solutions

-  Global Sourcing Solution
-  Obsolete Management
-  Cost Control Management
-  Shortage Management
-  Alternative Solution
-  Excess Inventory Management