

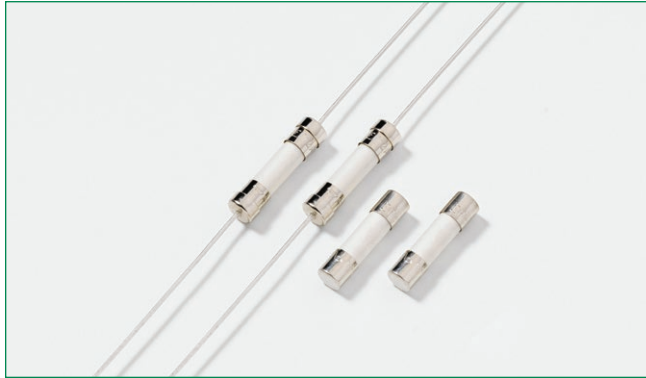

**THE DATASHEET OF**  
**021606.3HXP**



### 216 Series, 5x20 mm, Fast-Acting Fuse



#### Description

The 216 Series is a 5x20mm, Fast-Acting, ceramic body, cartridge fuse designed to IEC specifications

#### Features

- Recognized to UL/CSA/NMX 248-1 and UL/CSA/NMX 248-14
- Meets Standard Sheet 1 of IEC 60127-2 as a Fast-Acting fuse
- Available in cartridge and axial lead form
- RoHS compliant and lead-free
- Conforms to GB 9364.1 and GB 9364.2
- CE Mark indicates compliance with Low-Voltage and RoHS Directives.

#### Agency Approvals

Agency	Agency File Number	Ampere Range
	<b>Cartridge 216 Series</b> NBK 080205-E10480A NBK 250702-E10480E NBK 240108-JP1021C NBK 240108-JP1021E	1A-5A 6.3A-10A 12.5A 16A
	<b>Leaded 216E Series</b> NBK 080205-E10480B NBK 250702-E10480F NBK 240108-JP1021D NBK 240108-JP1021F	1A-5A 6.3A-10A 12.5A 16A
	2020970207000066	0.05A-10A
	SU05001-2013	1A – 10A
	E10480	0.05A – 16A
	29862	
	1706869	0.05A - 10A, 16A
	40013834	0.05A – 6.3A *8A, *10A
	40016442	*12.5A
	KM41462	1A – 6.3A
	J50248090	8A – 16A
	N/A	0.05A – 16A

\*Approval for Cartridge versions only

#### Applications

Used as supplementary protection in appliance or utilization equipment to provide individual protection for components or internal circuits.

#### Electrical Characteristics for Series

% of Ampere Rating	Ampere Rating	Opening Time
150%	0.05A – 4A	60 minutes, Minimum
	5A – 6.3A	60 minutes, Minimum
	8A – 16A	30 minutes, Minimum
210%	0.05A – 4A	30 minutes, Maximum
	5A – 6.3A	30 minutes, Maximum
	8A – 16A	30 minutes, Maximum
275%	0.05A – 4A	0.01 sec., Min.; 2 sec. Max.
	5A – 6.3A	0.01 sec., Min.; 3 sec. Max.
	8A – 16A	0.04 sec., Min.; 20 sec. Max.
400%	0.05A – 4A	0.003 sec., Min.; 0.3 sec. Max.
	5A – 6.3A	0.003 sec., Min.; 0.3 sec. Max.
	8A – 16A	0.01 sec., Min.; 1.0 sec. Max.
1000%	0.05A – 4A	0.02 seconds, Maximum
	5A – 6.3A	0.02 seconds, Maximum
	8A – 16A	0.03 seconds, Maximum

#### Additional Information



Datasheet



Resources



Samples



Accessories

For recommended fuse accessories for this product series, see '[Recommended Accessories](#)' section.

## Electrical Characteristics Specifications by Item

Amp Code	Amp Rating (A)	Voltage Rating (V)	Interrupting Rating*	Nominal Cold Resistance (Ohms)	Nominal Melting I <sup>2</sup> t (A <sup>2</sup> sec)	Maximum Voltage Drop at Rated Current (mV)	Maximum Power Dissipation at 1.5In (W)	Agency Approvals											
								UL	CCC	CSA	UL US	SP	S	CE	D E	VDE	UL	PS E	
0.050	0.05	250	1500A@250Vac	15.9000	0.00019	10000	1.6	-	-	X	X	X	X	X	X	X	-	-	-
0.063	0.063	250		10.4500	0.00079	8800	1.6	-	-	X	X	X	X	X	X	X	-	-	-
0.080	0.08	250		7.8850	0.00084	7600	1.6	-	-	X	X	X	X	X	X	X	-	-	-
0.100	0.1	250		5.7925	0.00450	7000	1.6	-	-	X	X	X	X	X	X	X	-	-	-
0.125	0.125	250		3.6750	0.00546	5000	1.6	-	-	X	X	X	X	X	X	X	-	-	-
0.160	0.16	250		5.3490	0.00326	4300	1.6	-	-	X	X	X	X	X	X	X	-	-	-
0.200	0.2	250		3.3500	0.00439	3500	1.6	-	-	X	X	X	X	X	X	X	-	-	-
0.250	0.25	250		2.3500	0.01350	2800	2.5	-	-	X	X	X	X	X	X	X	-	-	-
0.315	0.315	250		1.8500	0.02320	2500	2.5	-	-	X	X	X	X	X	X	X	-	-	-
0.500	0.5	250		0.8660	0.16500	1800	2.5	-	-	X	X	X	X	X	X	X	-	-	-
0.630	0.63	250		0.4650	0.05940	1500	2.5	-	-	X	X	X	X	X	X	X	-	-	-
0.800	0.8	250		0.2950	0.14600	1200	2.5	-	-	X	X	X	X	X	X	X	-	-	-
001.0	1	250		0.2370	0.18000	1000	2.5	X	X	X	X	X	X	X	X	X	-	-	X
1.25	1.25	250		0.1530	0.48000	800	4	X	X	X	X	X	X	X	X	X	-	-	X
01.6	1.6	250		0.1112	1.00500	600	4	X	X	X	X	X	X	X	X	X	-	-	X
002.0	2	250		0.0764	1.87000	500	4	X	X	X	X	X	X	X	X	X	-	-	X
02.5	2.5	250		0.0584	3.67200	400	4	X	X	X	X	X	X	X	X	X	-	-	X
3.15	3.15	250		0.0368	6.70000	350	4	X	X	X	X	X	X	X	X	X	-	-	X
004.0	4	250		0.0247	14.99500	300	4	X	X	X	X	X	X	X	X	X	-	-	X
005.0	5	250		0.0183	27.46000	250	4	X	X	X	X	X	X	X	X	X	-	-	X
06.3	6.3	250	0.0137	56.43000	200	4	X	X	X	X	X	X	X	X	X	-	-	X	
008.0	8	250	0.0123	64.31500	200	4	-	X	X	X	X	X	X	X	X*	-	X	X	
010.0	10	250	0.0079	154.34000	200	4	-	X	X	X	X	X	X	X	X*	-	X	X	
12.5	12.5	250	0.0057	175.00000	200	N/A**	-	-	X	X	-	X	-	X*	-	X*	X	X	
016.	16	250	0.0040	462.50000	200	N/A**	-	-	-	X***	X	X	X	-	-	X***	X	X	

\* - Approval for cartridge versions only.  
 \*\* - Please contact Littelfuse for details on these parameters  
 I<sup>2</sup>t test at 10x rated current  
 \*\*\* - 1500A@250Vac for 16A  
 \*Interrupting Rating may differ based on Agency Approval. See Agency Approval certificate for more details.

### Temperature Re-rating Curve

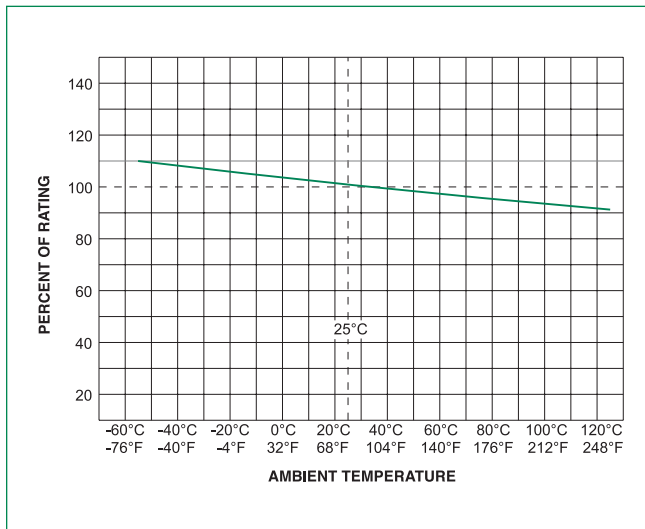

### Average Time Current Curves

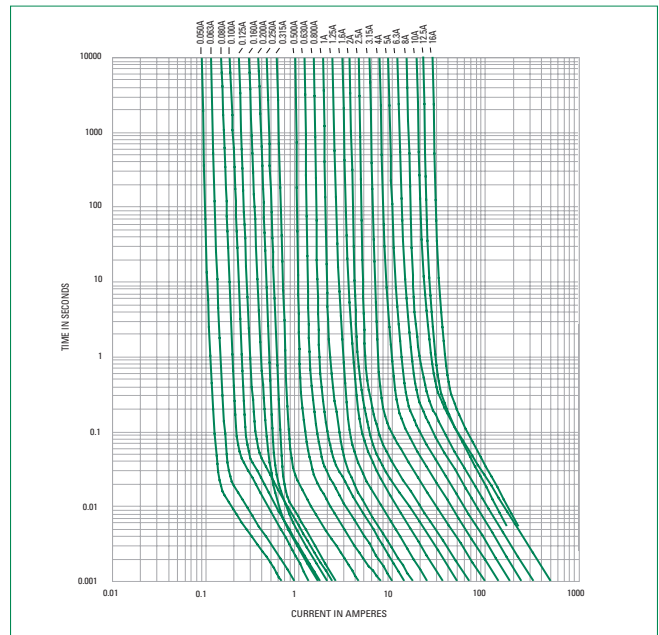

### Soldering Parameters - Wave Soldering

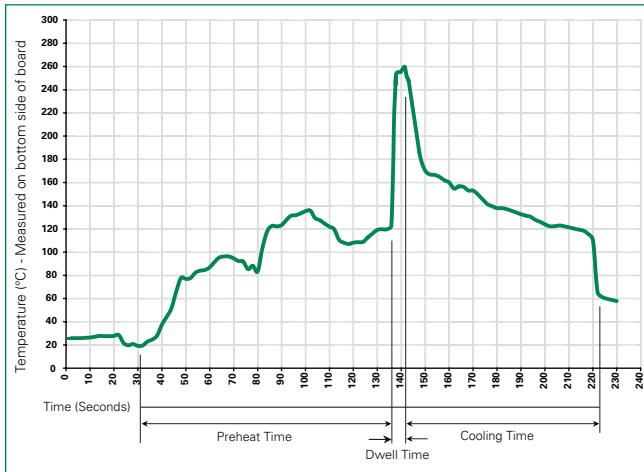

### Recommended Process Parameters:

Wave Parameter	Lead-Free Recommendation
Preheat: (Depends on Flux Activation Temperature)	(Typical Industry Recommendation)
Temperature Minimum:	100°C
Temperature Maximum:	150°C
Preheat Time:	60-180 seconds
Solder Pot Temperature:	260°C Maximum
Solder Dwell Time:	2-5 seconds

### Recommended Hand-Solder Parameters:

Solder Iron Temperature: 350°C +/- 5°C  
Heating Time: 5 seconds max.

**Note:** These devices are not recommended for IR or Convection Reflow process.

### Product Characteristics

<b>Material</b>	Body: Ceramic Cap: Nickel-plated brass Leads: Tin-plated Copper Filler (160mA-16A): Sand
<b>Terminal Strength</b>	MIL-STD-202, Method 211, Test Condition A
<b>Solderability</b>	MIL-STD-202 Method 208
<b>Product Marking</b>	Cap 1: Brand logo, current and voltage rating Cap 2: Agency approval markings
<b>Packaging</b>	Available in Bulk (M=1000 pcs/pkg) or on Tape/Reel (MRET1=1000 pcs/reel)

<b>Operating Temperature</b>	-55°C to +125°C
<b>Thermal Shock</b>	MIL-STD-202, Method 107, Test Condition B: (5 cycles -65°C to +125°C)
<b>Vibration</b>	MIL-STD-202, Method 201
<b>Humidity</b>	MIL-STD-202, Method 103, Test Condition A. high RH (95%) and elevated temperature (40°C) for 240 hours.
<b>Salt Spray</b>	MIL-STD-202, Method 101, Test Condition B

### Dimensions

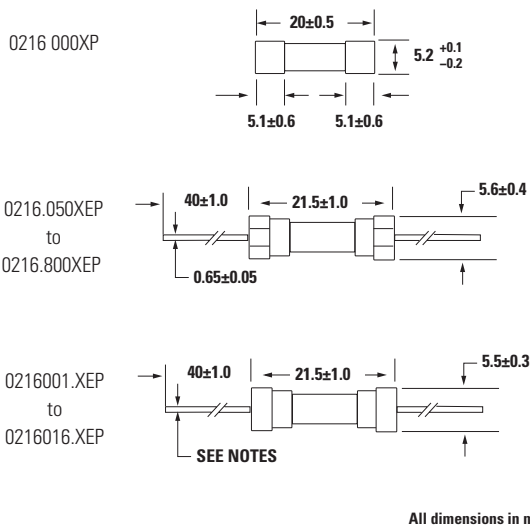

- Notes:**
- 0.05A-6.3A have 0.65±0.05 diameter lead.
  - 8A-16A have 0.8±0.05 diameter lead.

### Part Numbering System

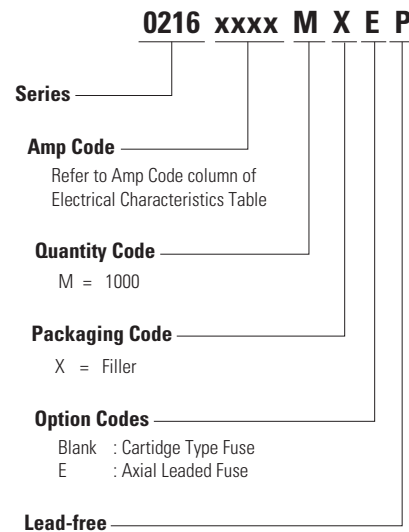

### Packaging

Packaging Option	Packaging Specification	Quantity	Quantity & Packaging Code	Taping Width
<b>216 Series</b>				
Bulk	N/A	1000	MX	N/A
Bulk	N/A	1000	MXE	N/A
Reel and Tape	EIA 296-E	1000	MRET1	T1=53mm (2.087")
Bulk	N/A	1000	MXG	N/A
Bulk	N/A	1000	MXB	N/A
Bulk	N/A	100	HX	N/A

### Recommended Accessories

Accessory Type	Series	Description	Max Application Voltage	Max Application Amperage
Holder	<a href="#">345_ISF</a>	Panel Mount Shock-Safe Fuseholder	250	10
	<a href="#">345</a>	Shock-Safe Fuseholder with PC Mount, Solder Mount and Panel Mount options		20
	<a href="#">830</a>	PC Mount Shock-Safe Miniature Fuseholder		16
Block	<a href="#">520</a>	Metric OMNI-BLOK® Fuse Block		10
	<a href="#">646</a>	PC Mount Miniature Fuse Block		6.3
	<a href="#">658</a>	Surface Mount Miniature Fuse Block		10
Clip	<a href="#">520_W</a>	PC Mount Miniature Fuse Clip		6.3
	<a href="#">111</a>	PC Board Mount Fuse Clip		10
	<a href="#">445</a>	PC Board Mount Fuse Clip		10

**Notes:**

1. Do not use in applications above rating.
2. Please refer to fuseholder data sheet for specific re-rating information.
3. Please contact Littelfuse for applications greater than the max voltage and amperage shown.



## Looking for pricing, stock, or lifecycle information?

Click below to explore more details on WIN SOURCE:

 [View 021606.3HXP on WIN SOURCE](#)

 [Littelfuse Inc. Information](#)

## Optimize Your Supply Chain with WIN SOURCE Solutions

-  Global Sourcing Solution
-  Obsolete Management
-  Cost Control Management
-  Shortage Management
-  Alternative Solution
-  Excess Inventory Management