

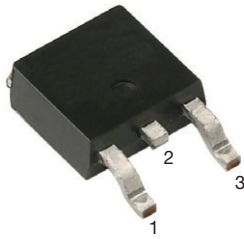

**THE DATASHEET OF  
VS-50WQ03FNTRHM3**



## High Performance Schottky Rectifier, 5.5 A



DPAK (TO-252AA)

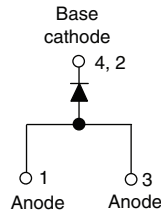

### FEATURES

- Low forward voltage drop
- Guard ring for enhanced ruggedness and long term reliability
- Popular DPAK outline
- Small foot print, surface mountable
- High frequency operation
- Meets MSL level 1, per J-STD-020, LF maximum peak of 260 °C
- AEC-Q101 qualified, meets JESD 201 class 2 whisker test
- Material categorization: for definitions of compliance please see [www.vishay.com/doc?99912](http://www.vishay.com/doc?99912)

**RoHS**  
 COMPLIANT  
 HALOGEN  
**FREE**

### DESCRIPTION

The VS-50WQ03FNHM3 surface mount Schottky rectifier has been designed for applications requiring low forward drop and small foot prints on PC board. Typical applications are in disk drives, switching power supplies, converters, freewheeling diodes, battery charging, and reverse battery protection.

### PRIMARY CHARACTERISTICS

$I_{F(AV)}$	5.5 A
$V_R$	30 V
$V_F$ at $I_F$	See Electrical table
$I_{RM}$	58 mA at 125 °C
$T_J$ max.	150 °C
$E_{AS}$	10 mJ
Package	DPAK (TO-252AA)
Circuit configuration	Single

### MAJOR RATINGS AND CHARACTERISTICS

SYMBOL	CHARACTERISTICS	VALUES	UNITS
$I_{F(AV)}$	Rectangular waveform	5.5	A
$V_{RRM}$		30	V
$I_{FSM}$	$t_p = 5 \mu s$ sine	320	A
$V_F$	$5 A_{pk}$ , $T_J = 125 \text{ °C}$	0.35	V
$T_J$	Range	-40 to +150	°C

### VOLTAGE RATINGS

PARAMETER	SYMBOL	VS-50WQ03FNHM3	UNITS
Maximum DC reverse voltage	$V_R$	30	V
Maximum working peak reverse voltage	$V_{RWM}$		

### ABSOLUTE MAXIMUM RATINGS

PARAMETER	SYMBOL	TEST CONDITIONS	VALUES	UNITS
Maximum average forward current See fig. 5	$I_{F(AV)}$	50 % duty cycle at $T_C = 136 \text{ °C}$ , rectangular waveform	5.5	A
Maximum peak one cycle non-repetitive surge current See fig. 7	$I_{FSM}$	5 $\mu s$ sine or 3 $\mu s$ rect. pulse	Following any rated load condition and with rated $V_{RRM}$ applied	320
		10 ms sine or 6 ms rect. pulse		130
Non-repetitive avalanche energy	$E_{AS}$	$T_J = 25 \text{ °C}$ , $I_{AS} = 2 \text{ A}$ , $L = 5 \text{ mH}$	10	mJ
Repetitive avalanche current	$I_{AR}$	Current decaying linearly to zero in 1 $\mu s$ Frequency limited by $T_J$ maximum $V_A = 1.5 \times V_R$ typical	2.0	A



ELECTRICAL SPECIFICATIONS					
PARAMETER	SYMBOL	TEST CONDITIONS		VALUES	UNITS
Maximum forward voltage drop See fig. 1	V <sub>FM</sub> <sup>(1)</sup>	5 A	T <sub>J</sub> = 25 °C	0.46	V
		10 A		0.53	
		5 A	T <sub>J</sub> = 125 °C	0.35	
		10 A		0.46	
Maximum reverse leakage current See fig. 2	I <sub>RM</sub> <sup>(1)</sup>	T <sub>J</sub> = 25 °C	V <sub>R</sub> = rated V <sub>R</sub>	3	mA
		T <sub>J</sub> = 125 °C		58	
Threshold voltage	V <sub>F(TO)</sub>	T <sub>J</sub> = T <sub>J</sub> maximum		0.19	V
Forward slope resistance	r <sub>t</sub>			22.22	mΩ
Typical junction capacitance	C <sub>T</sub>	V <sub>R</sub> = 5 V <sub>DC</sub> (test signal range 100 kHz to 1 MHz), 25 °C		590	pF
Typical series inductance	L <sub>S</sub>	Measured lead to lead 5 mm from package body		5.0	nH

Note

(1) Pulse width < 300 μs, duty cycle < 2 %

THERMAL - MECHANICAL SPECIFICATIONS					
PARAMETER	SYMBOL	TEST CONDITIONS		VALUES	UNITS
Maximum junction and storage temperature range	T <sub>J</sub> <sup>(1)</sup> , T <sub>Stg</sub>			-40 to +150	°C
Maximum thermal resistance, junction to case	R <sub>thJC</sub>	DC operation See fig. 4		3.0	°C/W
Approximate weight				0.3	g
				0.01	oz.
Marking device		Case style DPAK (TO-252AA)		50WQ03FNH	

Note

(1)  $\frac{dP_{tot}}{dT_J} < \frac{1}{R_{thJA}}$  thermal runaway condition for a diode on its own heatsink

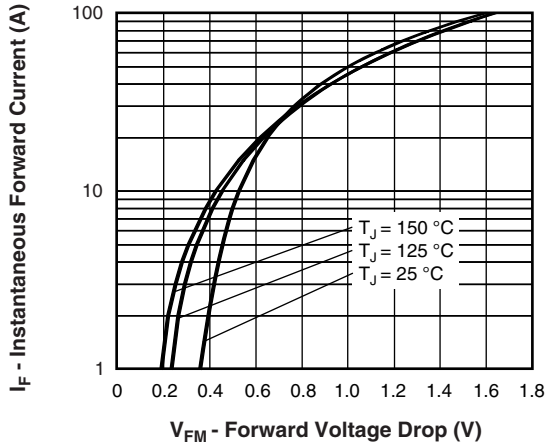

Fig. 1 - Maximum Forward Voltage Drop Characteristics

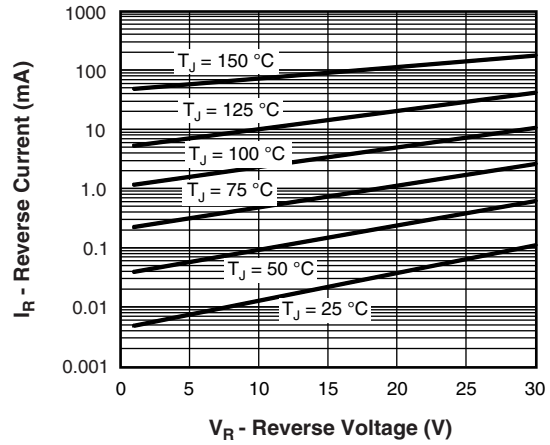

Fig. 2 - Typical Values of Reverse Current vs. Reverse Voltage

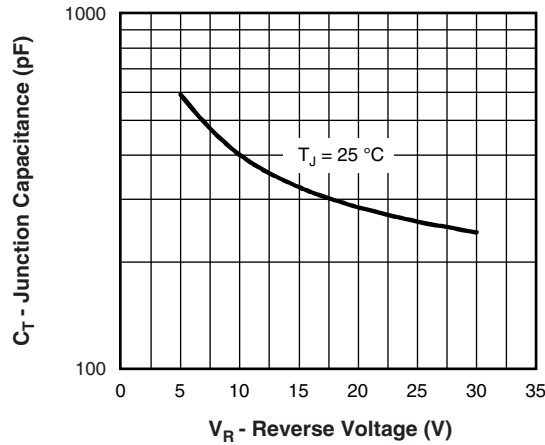

Fig. 3 - Typical Junction Capacitance vs. Reverse Voltage

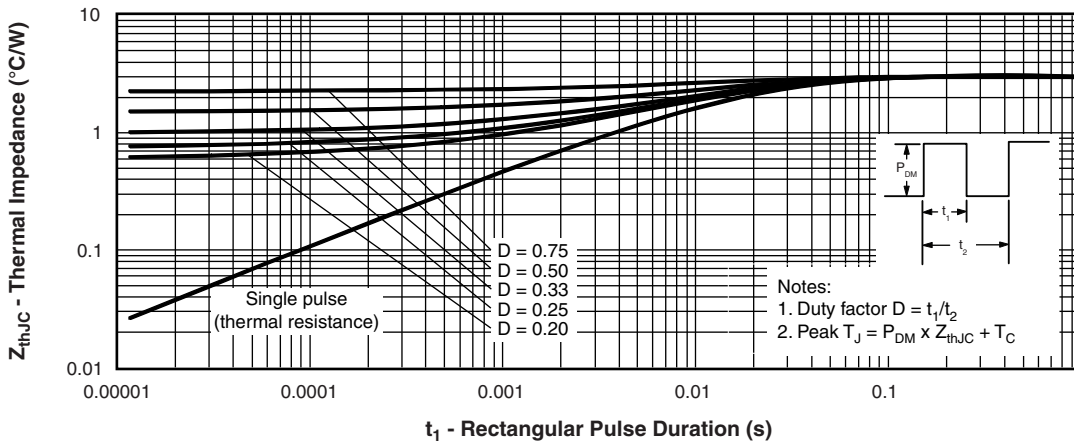

Fig. 4 - Maximum Thermal Impedance  $Z_{thJC}$  Characteristics

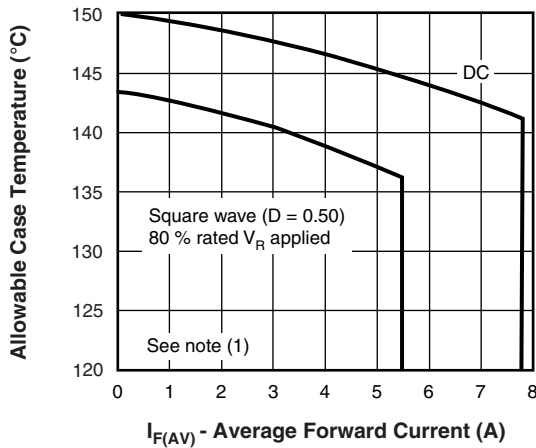

Fig. 5 - Maximum Allowable Case Temperature vs. Average Forward Current

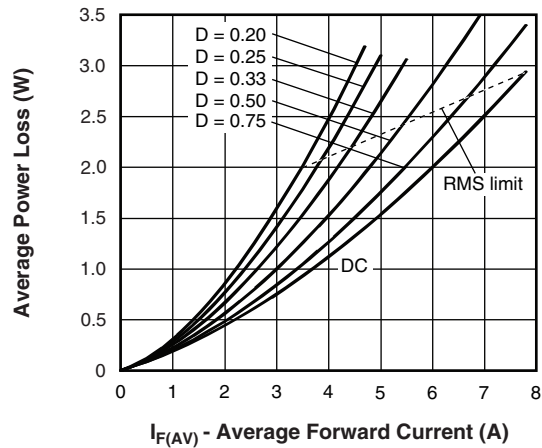

Fig. 6 - Forward Power Loss Characteristics

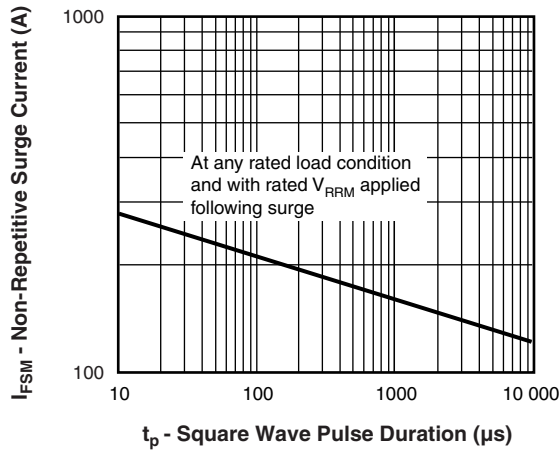

Fig. 7 - Maximum Non-Repetitive Surge Current

**Note**

- (1) Formula used:  $T_C = T_J - (P_d + P_{d_{REV}}) \times R_{thJC}$ ;
- $P_d$  = forward power loss =  $I_{F(AV)} \times V_{FM}$  at  $(I_{F(AV)}/D)$  (see fig. 6);
- $P_{d_{REV}}$  = inverse power loss =  $V_{R1} \times I_R (1 - D)$ ;  $I_R$  at  $V_{R1} = 80\%$  rated  $V_R$



## ORDERING INFORMATION TABLE

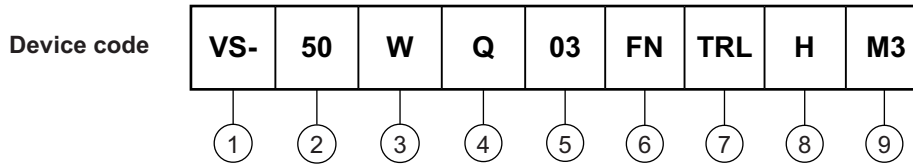

- 1** - Vishay Semiconductors product
- 2** - Current rating (5.5 A)
- 3** - Package identifier:  
W = DPAK
- 4** - Schottky "Q" series
- 5** - Voltage rating (03 = 30 V)
- 6** - FN = TO-252AA (DPAK)
- 7** -
  - None = tube
  - TR = tape and reel
  - TRL = tape and reel (left oriented)
  - TRR = tape and reel (right oriented)
- 8** - H = AEC-Q101 qualified
- 9** - Environmental digit:  
M3 = halogen-free, RoHS-compliant and terminations lead (Pb)-free

ORDERING INFORMATION (Example)			
PREFERRED P/N	QUANTITY PER T/R	MINIMUM ORDER QUANTITY	PACKAGING DESCRIPTION
VS-50WQ03FNHM3	75	3000	Antistatic plastic tube
VS-50WQ03FNTRHM3	2000	2000	13" diameter reel
VS-50WQ03FNTRLHM3	3000	3000	13" diameter reel
VS-50WQ03FNTRRHM3	3000	3000	13" diameter reel

LINKS TO RELATED DOCUMENTS	
Dimensions	<a href="http://www.vishay.com/doc?95519">www.vishay.com/doc?95519</a>
Part marking information	<a href="http://www.vishay.com/doc?95518">www.vishay.com/doc?95518</a>
Packaging information	<a href="http://www.vishay.com/doc?95033">www.vishay.com/doc?95033</a>

### DPAK (TO-252AA)

#### DIMENSIONS in millimeters and inches

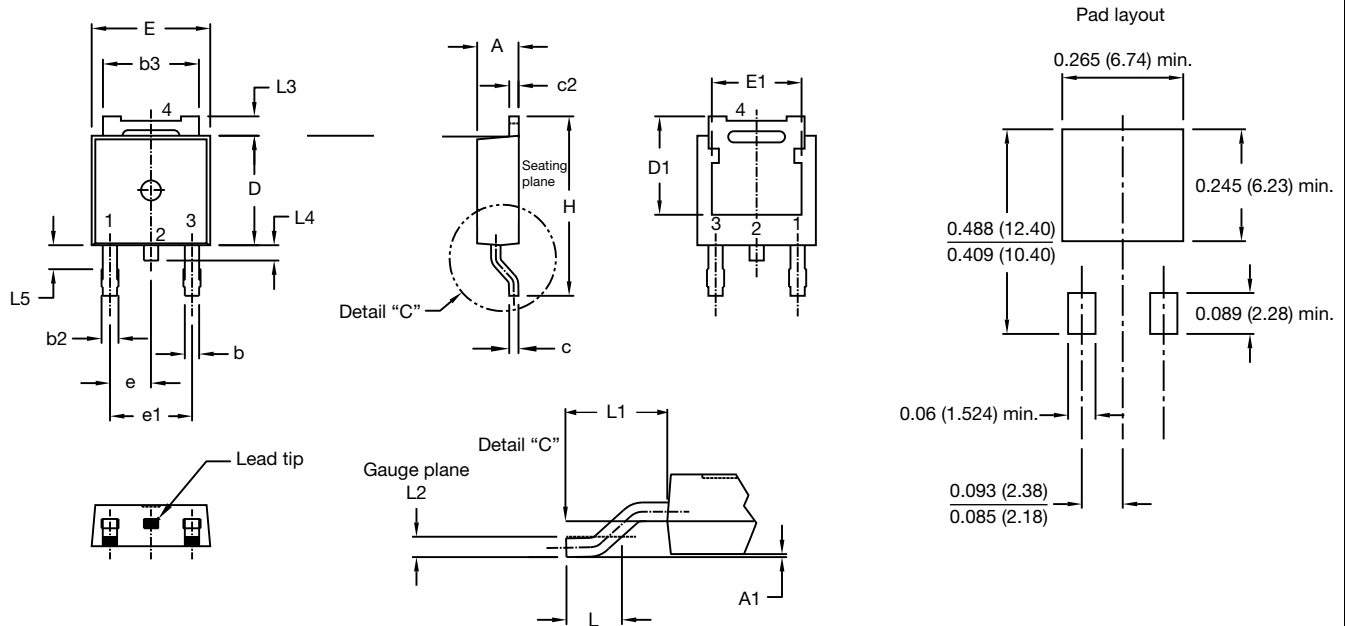

SYMBOL	MILLIMETERS		INCHES		NOTES	SYMBOL	MILLIMETERS		INCHES		NOTES
	MIN.	MAX.	MIN.	MAX.			MIN.	MAX.	MIN.	MAX.	
A	2.18	2.39	0.086	0.094		e	2.29 BSC		0.090 BSC		
A1	-	0.13	-	0.005		H	9.40	10.41	0.370	0.410	
b	0.64	0.89	0.025	0.035		L	1.40	1.78	0.055	0.070	
b2	0.76	1.14	0.030	0.045		L1	2.74 BSC		0.108 REF.		
b3	4.95	5.46	0.195	0.215	3	L2	0.51 BSC		0.020 BSC		
c	0.46	0.61	0.018	0.024		L3	0.89	1.27	0.035	0.050	3
c2	0.46	0.89	0.018	0.035		L4	-	1.02	-	0.040	
D	5.97	6.22	0.235	0.245	5	L5	1.14	1.52	0.045	0.060	2
D1	4.93	-	0.194	-	3						
E	6.35	6.73	0.250	0.265	5						
E1	4.32	-	0.170	-	3						

#### Notes

- (1) Dimensioning and tolerancing as per ASME Y14.5M-1994
- (2) Lead dimension uncontrolled in L5
- (3) Dimension D1, E1, L3 and b3 establish a minimum mounting surface for thermal pad
- (4) Dimensions D and E do not include mold flash. Mold flash shall not exceed 0.127 mm (0.005") per side. These dimensions are measured at the outermost extremes of the plastic body
- (5) Outline conforms to JEDEC® outline TO-252AA, except for D1 dimension



## Disclaimer

ALL PRODUCT, PRODUCT SPECIFICATIONS AND DATA ARE SUBJECT TO CHANGE WITHOUT NOTICE TO IMPROVE RELIABILITY, FUNCTION OR DESIGN OR OTHERWISE.

Vishay Intertechnology, Inc., its affiliates, agents, and employees, and all persons acting on its or their behalf (collectively, "Vishay"), disclaim any and all liability for any errors, inaccuracies or incompleteness contained in any datasheet or in any other disclosure relating to any product.

Vishay makes no warranty, representation or guarantee regarding the suitability of the products for any particular purpose or the continuing production of any product. To the maximum extent permitted by applicable law, Vishay disclaims (i) any and all liability arising out of the application or use of any product, (ii) any and all liability, including without limitation special, consequential or incidental damages, and (iii) any and all implied warranties, including warranties of fitness for particular purpose, non-infringement and merchantability.

Statements regarding the suitability of products for certain types of applications are based on Vishay's knowledge of typical requirements that are often placed on Vishay products in generic applications. Such statements are not binding statements about the suitability of products for a particular application. It is the customer's responsibility to validate that a particular product with the properties described in the product specification is suitable for use in a particular application. Parameters provided in datasheets and / or specifications may vary in different applications and performance may vary over time. All operating parameters, including typical parameters, must be validated for each customer application by the customer's technical experts. Product specifications do not expand or otherwise modify Vishay's terms and conditions of purchase, including but not limited to the warranty expressed therein.

Hyperlinks included in this datasheet may direct users to third-party websites. These links are provided as a convenience and for informational purposes only. Inclusion of these hyperlinks does not constitute an endorsement or an approval by Vishay of any of the products, services or opinions of the corporation, organization or individual associated with the third-party website. Vishay disclaims any and all liability and bears no responsibility for the accuracy, legality or content of the third-party website or for that of subsequent links.

Except as expressly indicated in writing, Vishay products are not designed for use in medical, life-saving, or life-sustaining applications or for any other application in which the failure of the Vishay product could result in personal injury or death. Customers using or selling Vishay products not expressly indicated for use in such applications do so at their own risk. Please contact authorized Vishay personnel to obtain written terms and conditions regarding products designed for such applications.

No license, express or implied, by estoppel or otherwise, to any intellectual property rights is granted by this document or by any conduct of Vishay. Product names and markings noted herein may be trademarks of their respective owners.

## Looking for pricing, stock, or lifecycle information?

Click below to explore more details on WIN SOURCE:

 [View VS-50WQ03FNTRHM3 on WIN SOURCE](#)

 [Vishay Information](#)

## Optimize Your Supply Chain with WIN SOURCE Solutions

-  Global Sourcing Solution
-  Obsolete Management
-  Cost Control Management
-  Shortage Management
-  Alternative Solution
-  Excess Inventory Management