



**THE DATASHEET OF  
VS-30CTQ045-M3**





## High Performance Schottky Rectifier, 2 x 15 A

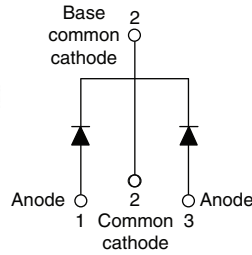

### FEATURES

- 175 °C T<sub>J</sub> operation
- Very low forward voltage drop
- High frequency operation
- High purity, high temperature epoxy encapsulation for enhanced mechanical strength and moisture resistance
- Guard ring for enhanced ruggedness and long term reliability
- Designed and qualified according to JEDEC®-JESD 47
- Material categorization: for definitions of compliance please see [www.vishay.com/doc?99912](http://www.vishay.com/doc?99912)



RoHS COMPLIANT HALOGEN FREE

PRIMARY CHARACTERISTICS	
I <sub>F(AV)</sub>	2 x 15 A
V <sub>R</sub>	35 V, 40 V, 45 V
V <sub>F</sub> at I <sub>F</sub>	0.56 V
I <sub>RM</sub> max.	15 mA at 125 °C
T <sub>J</sub> max.	175 °C
E <sub>AS</sub>	20 mJ
Package	TO-220AB 3L
Circuit configuration	Common cathode

### DESCRIPTION

The VS-30CTQ... center tap Schottky rectifier has been optimized for very low forward voltage drop, with moderate leakage. The proprietary barrier technology allows for reliable operation up to 175 °C junction temperature. Typical applications are in switching power supplies, converters, freewheeling diodes, and reverse battery protection.

MAJOR RATINGS AND CHARACTERISTICS				
SYMBOL	CHARACTERISTICS	VALUES	UNITS	
I <sub>F(AV)</sub>	Rectangular waveform	30	A	
V <sub>R</sub>		35 to 45	V	
I <sub>FSM</sub>	t <sub>p</sub> = 5 μs sine	1060	A	
V <sub>F</sub>	15 A <sub>pk</sub> , T <sub>J</sub> = 125 °C (per leg)	0.56	V	
T <sub>J</sub>		-55 to +175	°C	

VOLTAGE RATINGS					
PARAMETER	SYMBOL	VS-30CTQ035-M3	VS-30CTQ040-M3	VS-30CTQ045-M3	UNITS
Maximum DC reverse voltage	V <sub>R</sub>	35	40	45	V
Maximum working peak reverse voltage	V <sub>RWM</sub>				

ABSOLUTE MAXIMUM RATINGS					
PARAMETER	SYMBOL	TEST CONDITIONS		VALUES	UNITS
Maximum average forward current See fig. 5	I <sub>F(AV)</sub>	50 % duty cycle at T <sub>C</sub> = 127 °C, rectangular waveform		30	A
Maximum peak one cycle non-repetitive surge current per leg See fig. 7	I <sub>FSM</sub>	5 μs sine or 3 μs rect. pulse	Following any rated load condition and with rated V <sub>RRM</sub> applied	1060	
		10 ms sine or 6 ms rect. pulse		265	
Non-repetitive avalanche energy per leg	E <sub>AS</sub>	T <sub>J</sub> = 25 °C, I <sub>AS</sub> = 3.0 A, L = 4.40 mH		20	mJ
Repetitive avalanche current per leg	I <sub>AR</sub>	Current decaying linearly to zero in 1 μs Frequency limited by T <sub>J</sub> maximum V <sub>A</sub> = 1.5 x V <sub>R</sub> typical		3.0	A



<b>ELECTRICAL SPECIFICATIONS</b>					
PARAMETER	SYMBOL	TEST CONDITIONS		VALUES	UNITS
Maximum forward voltage drop per leg See fig. 1	$V_{FM}^{(1)}$	15 A	$T_J = 25\text{ }^\circ\text{C}$	0.62	V
		30 A		0.76	
		15 A	$T_J = 125\text{ }^\circ\text{C}$	0.56	
		30 A		0.70	
Maximum reverse leakage current per leg See fig. 2	$I_{RM}^{(1)}$	$T_J = 25\text{ }^\circ\text{C}$	$V_R = \text{Rated } V_R$	2	mA
		$T_J = 125\text{ }^\circ\text{C}$		15	
Maximum junction capacitance per leg	$C_T$	$V_R = 5\text{ }V_{DC}$ (test signal range 100 kHz to 1 MHz) 25 °C		900	pF
Typical series inductance per leg	$L_S$	Measured lead to lead 5 mm from package body		8.0	nH
Maximum voltage rate of change	dV/dt	Rated $V_R$		10 000	V/ $\mu$ s

**Note**<sup>(1)</sup> Pulse width < 300  $\mu$ s, duty cycle < 2 %

<b>THERMAL - MECHANICAL SPECIFICATIONS</b>					
PARAMETER	SYMBOL	TEST CONDITIONS		VALUES	UNITS
Maximum junction and storage temperature range	$T_J, T_{Stg}$			-55 to +175	°C
Maximum thermal resistance, junction to case per leg	$R_{thJC}$	DC operation See fig. 4		3.25	°C/W
Maximum thermal resistance, junction to case per package		DC operation		1.63	
Typical thermal resistance, case to heatsink	$R_{thCS}$	Mounting surface, smooth and greased		0.50	
Approximate weight				2.0	g
				0.07	oz.
Mounting torque	minimum maximum			6 (5)	kgf · cm (lbf · in)
				12 (10)	
Marking device		Case style TO-220AB 3L		30CTQ035	
				30CTQ040	
				30CTQ045	

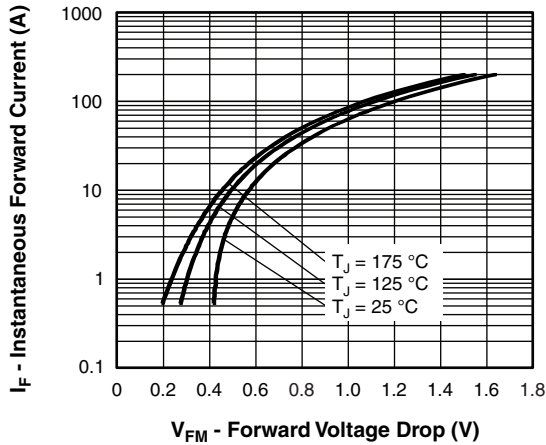

Fig. 1 - Maximum Forward Voltage Drop Characteristics (Per Leg)

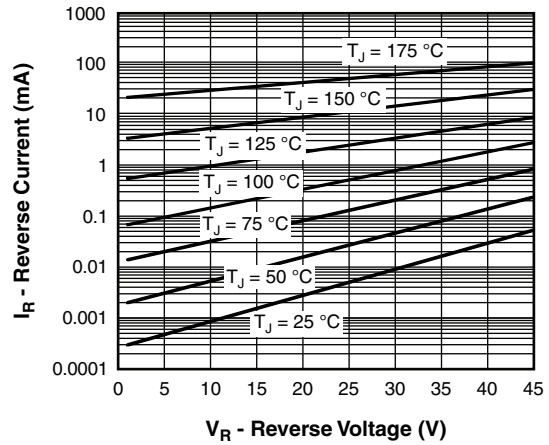

Fig. 2 - Typical Values of Reverse Current vs. Reverse Voltage (Per Leg)

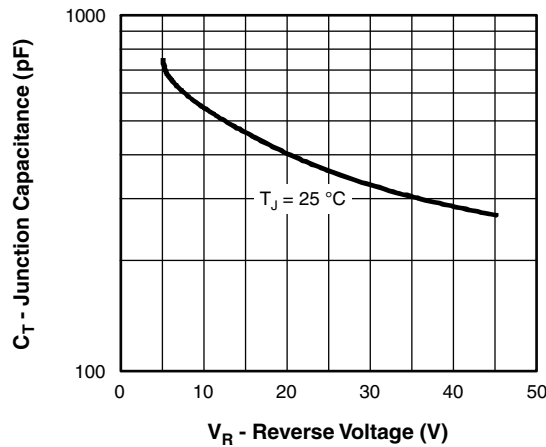

Fig. 3 - Typical Junction Capacitance vs. Reverse Voltage (Per Leg)

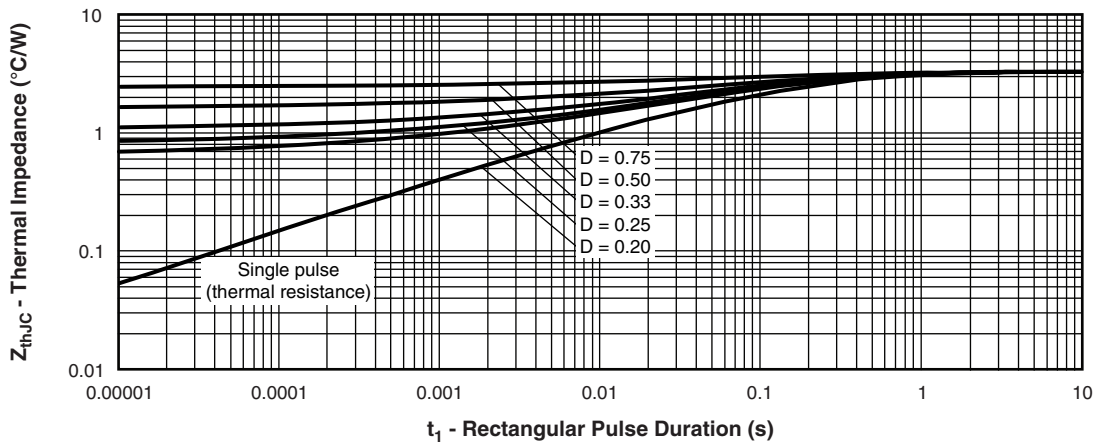

Fig. 4 - Maximum Thermal Impedance  $Z_{thJC}$  Characteristics (Per Leg)

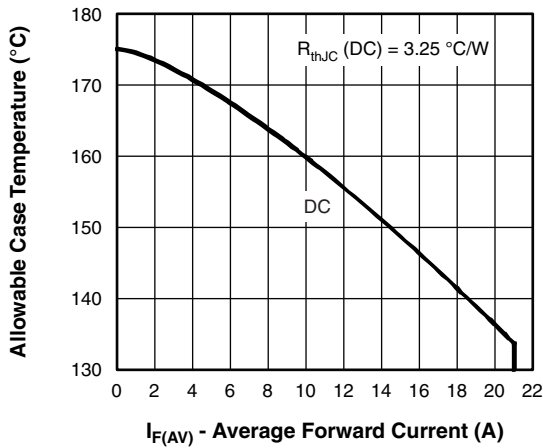

Fig. 5 - Maximum Allowable Case Temperature vs. Average Forward Current (Per Leg)

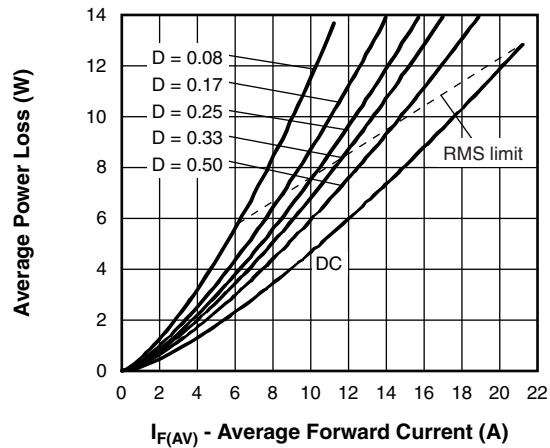

Fig. 6 - Forward Power Loss Characteristics (Per Leg)

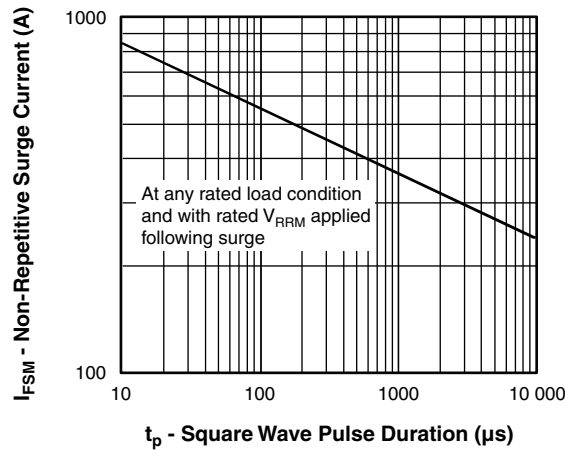

Fig. 7 - Maximum Non-Repetitive Surge Current (Per Leg)

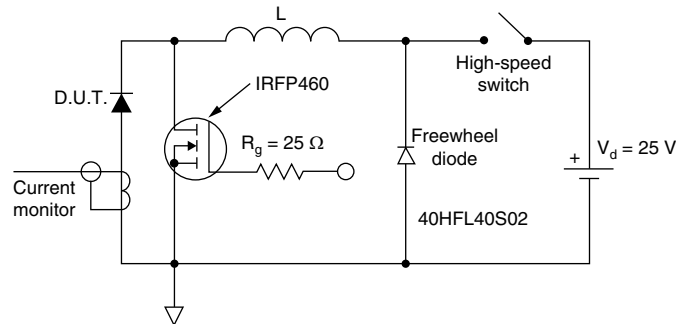
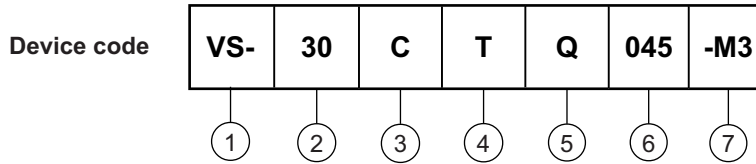

Fig. 8 - Unclamped Inductive Test Circuit



## ORDERING INFORMATION TABLE



- 1** - Vishay Semiconductors product
- 2** - Current rating (30 = 30 A)
- 3** - Circuit configuration:  
C = Common cathode
- 4** - Package:  
T = TO-220
- 5** - Schottky "Q" series
- 6** - Voltage ratings
 

035 = 35 V
040 = 40 V
045 = 45 V
- 7** - Environmental digit  
-M3 = halogen-free, RoHS-compliant, and termination lead (Pb)-free

ORDERING INFORMATION (Example)		
PREFERRED P/N	BASE QUANTITY	PACKAGING DESCRIPTION
VS-30CTQ035-M3	50	Antistatic plastic tubes
VS-30CTQ040-M3	50	Antistatic plastic tubes
VS-30CTQ045-M3	50	Antistatic plastic tubes

LINKS TO RELATED DOCUMENTS	
Dimensions	<a href="http://www.vishay.com/doc?96154">www.vishay.com/doc?96154</a>
Part marking information	<a href="http://www.vishay.com/doc?95028">www.vishay.com/doc?95028</a>



TO-220AB 3L

**DIMENSIONS** in millimeters and inches

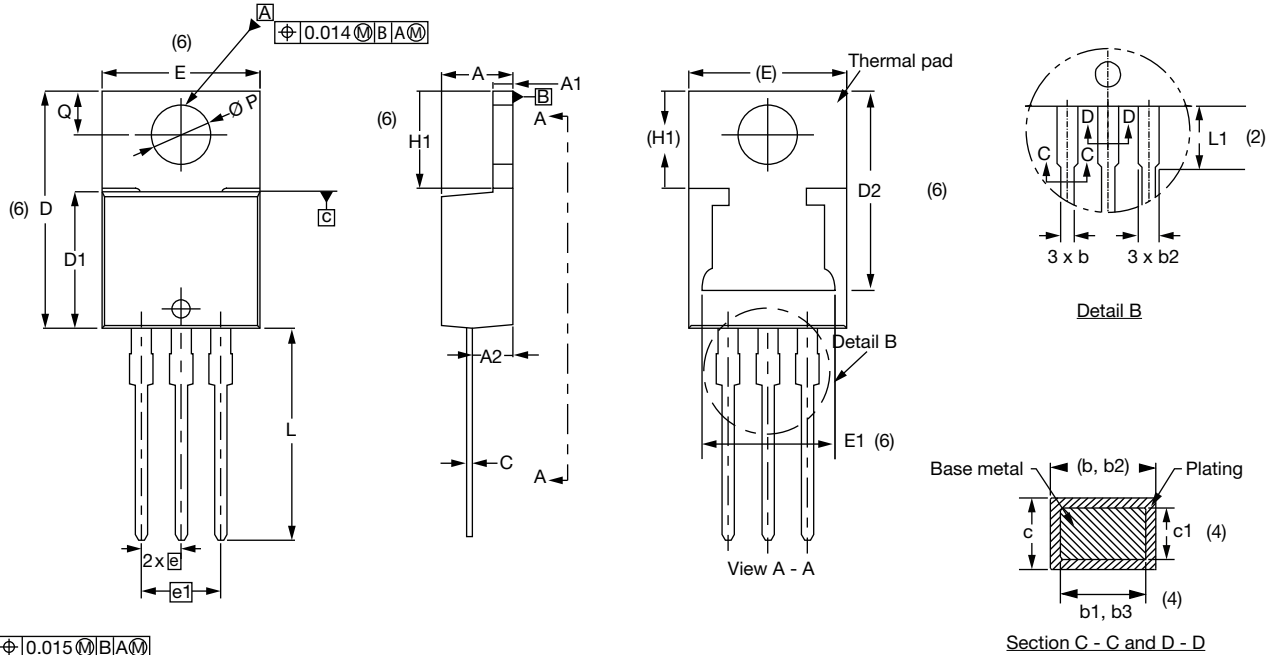

Conforms to JEDEC® outline TO-220AB

SYMBOL	MILLIMETERS		INCHES		NOTES	SYMBOL	MILLIMETERS		INCHES		NOTES
	MIN.	MAX.	MIN.	MAX.			MIN.	MAX.	MIN.	MAX.	
A	4.25	4.65	0.167	0.183		D2	11.68	13.30	0.460	0.524	6, 7
A1	1.14	1.40	0.045	0.055		E	10.11	10.51	0.398	0.414	3, 6
A2	2.50	2.92	0.098	0.115		E1	6.86	8.89	0.270	0.350	6
b	0.69	1.01	0.027	0.040		e	2.41	2.67	0.095	0.105	
b1	0.38	0.97	0.015	0.038	4	e1	4.88	5.28	0.192	0.208	
b2	1.20	1.73	0.047	0.068		H1	6.09	6.48	0.240	0.255	6
b3	1.14	1.73	0.045	0.068	4	L	13.52	14.02	0.532	0.552	
c	0.36	0.61	0.014	0.024		L1	3.32	3.82	0.131	0.150	2
c1	0.36	0.56	0.014	0.022	4	∅ P	3.54	3.91	0.139	0.154	
D	14.85	15.35	0.585	0.604	3	Q	2.60	3.00	0.102	0.118	
D1	8.38	9.02	0.330	0.355							

Notes

- (1) Dimensioning and tolerancing as per ASME Y14.5M-1994
- (2) Lead dimension and finish uncontrolled in L1
- (3) Dimension D, D1, and E do not include mold flash. Mold flash shall not exceed 0.127 mm (0.005") per side. These dimensions are measured at the outermost extremes of the plastic body
- (4) Dimension b1, b3, and c1 apply to base metal only
- (5) Controlling dimensions: inches
- (6) Thermal pad contour optional within dimensions E, H1, D2, and E1
- (7) Outline conforms to JEDEC® TO-220, except D2



## Disclaimer

ALL PRODUCT, PRODUCT SPECIFICATIONS AND DATA ARE SUBJECT TO CHANGE WITHOUT NOTICE TO IMPROVE RELIABILITY, FUNCTION OR DESIGN OR OTHERWISE.

Vishay Intertechnology, Inc., its affiliates, agents, and employees, and all persons acting on its or their behalf (collectively, "Vishay"), disclaim any and all liability for any errors, inaccuracies or incompleteness contained in any datasheet or in any other disclosure relating to any product.

Vishay makes no warranty, representation or guarantee regarding the suitability of the products for any particular purpose or the continuing production of any product. To the maximum extent permitted by applicable law, Vishay disclaims (i) any and all liability arising out of the application or use of any product, (ii) any and all liability, including without limitation special, consequential or incidental damages, and (iii) any and all implied warranties, including warranties of fitness for particular purpose, non-infringement and merchantability.

Statements regarding the suitability of products for certain types of applications are based on Vishay's knowledge of typical requirements that are often placed on Vishay products in generic applications. Such statements are not binding statements about the suitability of products for a particular application. It is the customer's responsibility to validate that a particular product with the properties described in the product specification is suitable for use in a particular application. Parameters provided in datasheets and / or specifications may vary in different applications and performance may vary over time. All operating parameters, including typical parameters, must be validated for each customer application by the customer's technical experts. Product specifications do not expand or otherwise modify Vishay's terms and conditions of purchase, including but not limited to the warranty expressed therein.

Hyperlinks included in this datasheet may direct users to third-party websites. These links are provided as a convenience and for informational purposes only. Inclusion of these hyperlinks does not constitute an endorsement or an approval by Vishay of any of the products, services or opinions of the corporation, organization or individual associated with the third-party website. Vishay disclaims any and all liability and bears no responsibility for the accuracy, legality or content of the third-party website or for that of subsequent links.

Except as expressly indicated in writing, Vishay products are not designed for use in medical, life-saving, or life-sustaining applications or for any other application in which the failure of the Vishay product could result in personal injury or death. Customers using or selling Vishay products not expressly indicated for use in such applications do so at their own risk. Please contact authorized Vishay personnel to obtain written terms and conditions regarding products designed for such applications.

No license, express or implied, by estoppel or otherwise, to any intellectual property rights is granted by this document or by any conduct of Vishay. Product names and markings noted herein may be trademarks of their respective owners.

## Looking for pricing, stock, or lifecycle information?

Click below to explore more details on WIN SOURCE:

 [View VS-30CTQ045-M3 on WIN SOURCE](#)

 [Vishay Information](#)

## Optimize Your Supply Chain with WIN SOURCE Solutions

-  Global Sourcing Solution
-  Obsolete Management
-  Cost Control Management
-  Shortage Management
-  Alternative Solution
-  Excess Inventory Management