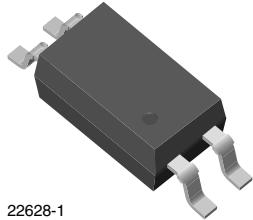




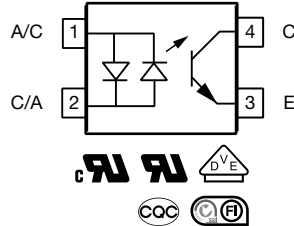
**THE DATASHEET OF  
VOS627A-2X001T**



## Optocoupler, Phototransistor Output, AC Input, SSOP-4, Half Pitch, Mini-Flat Package



22628-1



### DESCRIPTION

The VOS627A series has a GaAs infrared emitting diode emitter, which is optically coupled to a silicon planar phototransistor detector, and is incorporated in a 4-pin 50 mil lead pitch mini-flat package.

It features a high current transfer ratio at low input current, low coupling capacitance, and high isolation voltage.

The coupling devices are designed for signal transmission between two electrically separated circuits.

### FEATURES

- High CTR with low input current
- Low profile package (half pitch)
- High collector emitter voltage  $V_{CEO} = 80\text{ V}$
- Isolation test voltage =  $3750\text{ V}_{RMS}$
- Low coupling capacitance
- High common mode transient immunity
- Material categorization:  
For definitions of compliance please see [www.vishay.com/doc?99912](http://www.vishay.com/doc?99912)



### APPLICATIONS

- Telecom
- Industrial controls
- Battery powered equipment
- Office machines
- Programmable controllers

### AGENCY APPROVALS

Safety application model number covering all products in this datasheet is VOS627A. This model number should be used when consulting safety agency documents.

- UL1577, file no. E52744
- cUL
- DIN EN 60747-5-5 (VDE 0884-5), available with option 1
- FIMKO EN 60065, EN 60950-1
- CQC GB4943.1-2011 and GB8898-2011 (suitable for installation altitude below 2000 m)

ORDERING INFORMATION																															
<table border="1" style="width: 100%; border-collapse: collapse;"> <tr> <td style="text-align: center;">V</td> <td style="text-align: center;">O</td> <td style="text-align: center;">S</td> <td style="text-align: center;">6</td> <td style="text-align: center;">2</td> <td style="text-align: center;">7</td> <td style="text-align: center;">A</td> <td style="text-align: center;">-</td> <td style="text-align: center;">#</td> <td style="text-align: center;">X</td> <td style="text-align: center;">0</td> <td style="text-align: center;">0</td> <td style="text-align: center;">1</td> <td style="text-align: center;">T</td> </tr> <tr> <td colspan="8" style="text-align: center;">PART NUMBER</td> <td style="text-align: center;">CTR BIN</td> <td colspan="3" style="text-align: center;">PACKAGE OPTION</td> <td style="text-align: center;">TAPE AND REEL</td> </tr> </table>	V	O	S	6	2	7	A	-	#	X	0	0	1	T	PART NUMBER								CTR BIN	PACKAGE OPTION			TAPE AND REEL				
V	O	S	6	2	7	A	-	#	X	0	0	1	T																		
PART NUMBER								CTR BIN	PACKAGE OPTION			TAPE AND REEL																			
AGENCY CERTIFIED/PACKAGE	CTR (%)																														
	$\pm 5\text{ mA}$																														
<b>UL, cUL, FIMKO, CQC</b>	<b>50 to 600</b>	<b>63 to 125</b>	<b>100 to 200</b>	<b>160 to 320</b>																											
SSOP-4, 50 mil pitch	VOS627AT	VOS627A-2T	VOS627A-3T	VOS627A-4T																											
<b>UL, cUL, FIMKO, CQC, VDE (option 1)</b>	<b>50 to 600</b>	<b>63 to 125</b>	<b>100 to 200</b>	<b>160 to 320</b>																											
SSOP-4, 50 mil pitch	VOS627A-X001T	VOS627A-2X001T	VOS627A-3X001T	VOS627A-4X001T																											

#### Note

- Additional options may be possible, please contact sales office.



ABSOLUTE MAXIMUM RATINGS (T <sub>amb</sub> = 25 °C, unless otherwise specified)				
PARAMETER	TEST CONDITION	SYMBOL	VALUE	UNIT
<b>INPUT</b>				
Reverse voltage		V <sub>R</sub>	6	V
Power dissipation		P <sub>diss</sub>	70	mW
Surge forward current	t <sub>p</sub> ≤ 10 μs	I <sub>FSM</sub>	1.5	A
Forward current		I <sub>F</sub>	50	mA
<b>OUTPUT</b>				
Collector emitter voltage		V <sub>CEO</sub>	80	V
Emitter collector voltage		V <sub>ECO</sub>	7	V
Collector current		I <sub>C</sub>	50	mA
Power dissipation		P <sub>diss</sub>	150	mW
<b>COUPLER</b>				
Isolation test voltage between emitter and detector	t = 1 min	V <sub>ISO</sub>	3750	V <sub>RMS</sub>
Total power dissipation		P <sub>tot</sub>	170	mW
Storage temperature range		T <sub>stg</sub>	-55 to +150	°C
Ambient temperature range		T <sub>amb</sub>	-55 to +110	°C
Junction temperature		T <sub>j</sub>	125	°C
Soldering temperature <sup>(1)</sup>	t = 10 s	T <sub>slid</sub>	260	°C

**Notes**

- Stresses in excess of the absolute maximum ratings can cause permanent damage to the device. Functional operation of the device is not implied at these or any other conditions in excess of those given in the operational sections of this document. Exposure to absolute maximum ratings for extended periods of the time can adversely affect reliability.
- <sup>(1)</sup> Refer to reflow profile for soldering conditions for surface mounted devices.

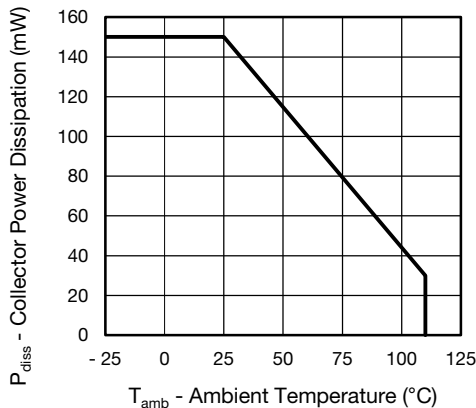


Fig. 1 - Power Dissipation vs. Ambient Temperature

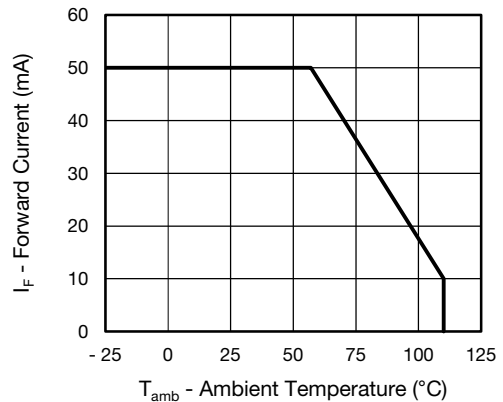


Fig. 2 - Forward Current vs. Ambient Temperature

<b>ELECTRICAL CHARACTERISTICS</b> ( $T_{amb} = 25\text{ }^{\circ}\text{C}$ , unless otherwise specified)						
PARAMETER	TEST CONDITION	SYMBOL	MIN.	TYP.	MAX.	UNIT
<b>INPUT</b>						
Forward voltage	$I_F = 50\text{ mA}$	$V_F$		1.1	1.5	V
Reverse current	$V_R = 6\text{ V}$	$I_R$		0.01	10	$\mu\text{A}$
Capacitance	$V_R = 0\text{ V}, f = 1\text{ MHz}$	$C_I$		7.3		pF
<b>OUTPUT</b>						
Collector emitter leakage current	$V_{CE} = 10\text{ V}$	$I_{CEO}$		0.3	100	nA
Collector emitter breakdown voltage	$I_C = 100\text{ }\mu\text{A}$	$BV_{CEO}$	80			V
Emitter collector breakdown voltage	$I_E = 10\text{ }\mu\text{A}$	$BV_{ECO}$	7			V
Collector emitter capacitance	$V_{CE} = 5\text{ V}, f = 1\text{ MHz}$	$C_{CE}$		5		pF
<b>COUPLER</b>						
Collector emitter saturation voltage	$I_F = 5\text{ mA}, I_C = 1.25\text{ mA}$	$V_{CEsat}$		0.25	0.4	V
Cut-off frequency	$I_F = 10\text{ mA}, V_{CC} = 5\text{ V}, R_L = 100\text{ }\Omega$	$f_{ctr}$		155		kHz

**Note**

- Minimum and maximum values are testing requirements. Typical values are characteristics of the device and are the result of engineering evaluation. Typical values are for information only and are not part of the testing requirements.

<b>CURRENT TRANSFER RATIO</b> ( $T_{amb} = 25\text{ }^{\circ}\text{C}$ , unless otherwise specified)							
PARAMETER	TEST CONDITION	PART	SYMBOL	MIN.	TYP.	MAX.	UNIT
$I_C/I_F$	$I_F = \pm 5\text{ mA}, V_{CE} = 5\text{ V}$	VOS627A	CTR	50		600	%
		VOS627A-2	CTR	63		125	%
		VOS627A-3	CTR	100		200	%
		VOS627A-4	CTR	160		320	%

<b>SWITCHING CHARACTERISTICS</b> ( $T_{amb} = 25\text{ }^{\circ}\text{C}$ , unless otherwise specified)						
PARAMETER	TEST CONDITION	SYMBOL	MIN.	TYP.	MAX.	UNIT
<b>NON-SATURATED</b>						
Rise and fall time	$I_C = 2\text{ mA}, V_{CC} = 5\text{ V}, R_L = 100\text{ }\Omega$	$t_r$		3		$\mu\text{s}$
Fall time		$t_f$		3		$\mu\text{s}$
Turn-on time		$t_{on}$		6		$\mu\text{s}$
Turn-off time		$t_{off}$		4		$\mu\text{s}$
<b>SATURATED</b>						
Rise and fall time	$I_F = 1.6\text{ mA}, V_{CC} = 5\text{ V}, R_L = 1.9\text{ k}\Omega$	$t_r$		3		$\mu\text{s}$
Fall time		$t_f$		12		$\mu\text{s}$
Turn-on time		$t_{on}$		4		$\mu\text{s}$
Turn-off time		$t_{off}$		18		$\mu\text{s}$

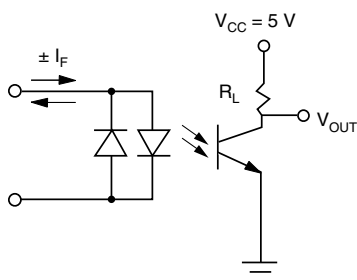


Fig. 3 - Test Circuit

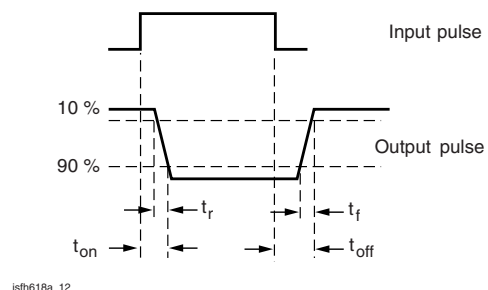


Fig. 4 - Test Circuit and Waveforms

SAFETY AND INSULATION RATINGS				
PARAMETER		SYMBOL	VALUE	UNIT
<b>MAXIMUM SAFETY RATINGS</b>				
Output safety power		$P_{SO}$	300	mW
Input safety current		$I_{si}$	200	mA
Safety temperature		$T_S$	150	°C
Comparative tracking index		CTI	175	
<b>INSULATION RATED PARAMETERS</b>				
Maximum withstanding isolation voltage	40 % to 60 % RH, AC test of 1 min	$V_{ISO}$	3750	$V_{RMS}$
Maximum transient isolation voltage		$V_{IOTM}$	6000	$V_{peak}$
Maximum repetitive peak isolation voltage		$V_{IORM}$	565	$V_{peak}$
Insulation resistance	$T_{amb} = 25\text{ °C}, V_{DC} = 500\text{ V}$	$R_{IO}$	$\geq 10^{12}$	$\Omega$
Isolation resistance	$T_{amb} = 100\text{ °C}, V_{DC} = 500\text{ V}$	$R_{IO}$	$\geq 10^{11}$	$\Omega$
Climatic classification (according to IEC 68 part 1)			55/110/21	
Environment (pollution degree in accordance to DIN VDE 0109)			2	
Creepage distance			$\geq 5$	mm
Clearance distance			$\geq 5$	mm
Insulation thickness			$\geq 0.4$	mm

**Note**

- As per IEC 60747-5-5, § 7.4.3.8.2, this optocoupler is suitable for “safe electrical insulation” only within the safety ratings. Compliance with the safety ratings shall be ensured by means of protective circuits.

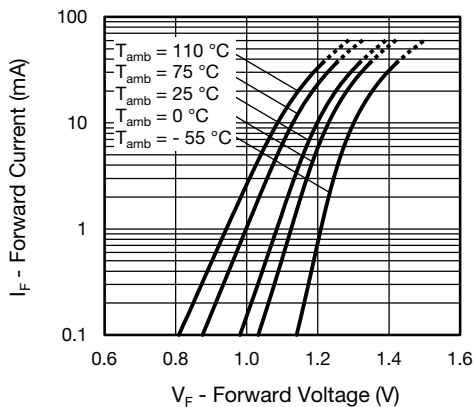
**TYPICAL CHARACTERISTICS** ( $T_{amb} = 25\text{ °C}$ , unless otherwise specified)


Fig. 5 - Forward Voltage vs. Forward Current

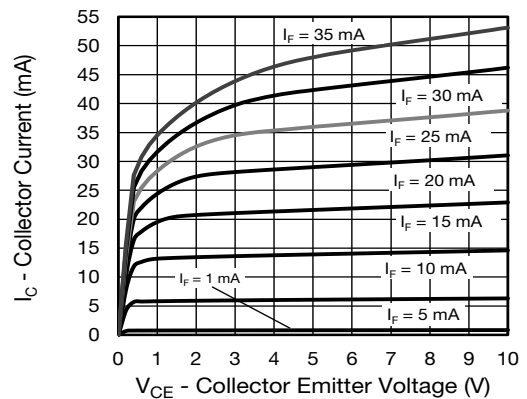


Fig. 6 - Collector Current vs. Collector Emitter Voltage

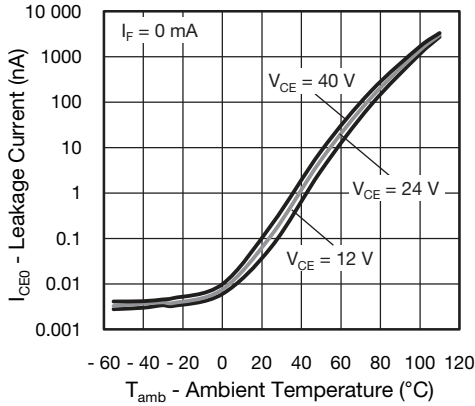


Fig. 7 - Leakage Current vs. Ambient Temperature

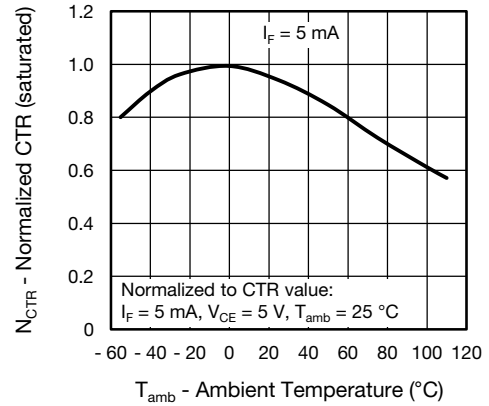


Fig. 10 - Normalized Current Transfer Ratio vs. Ambient Temperature

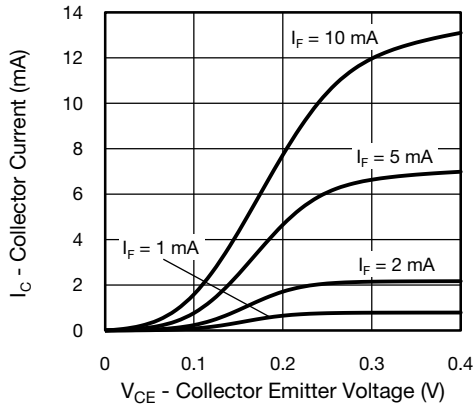


Fig. 8 - Collector Current vs. Collector Emitter Voltage

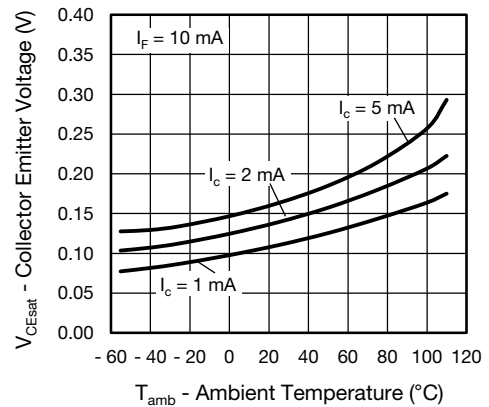


Fig. 11 - Collector Emitter Voltage vs. Ambient Temperature



Fig. 9 - Normalized Current Transfer Ratio vs. Ambient Temperature

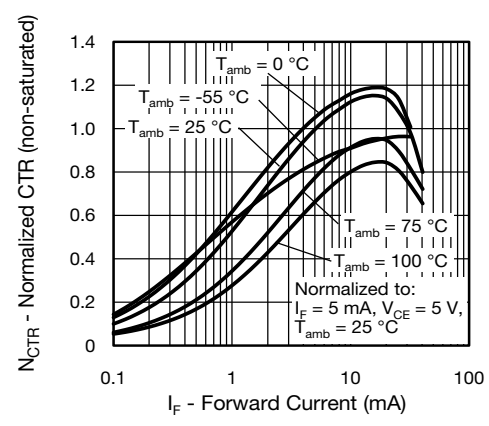


Fig. 12 - Normalized CTR vs. Forward Current

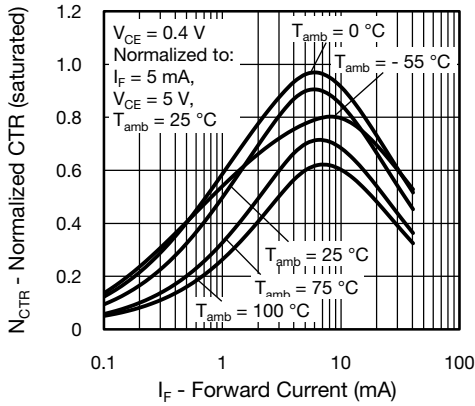


Fig. 13 - Normalized CTR vs. Forward Current

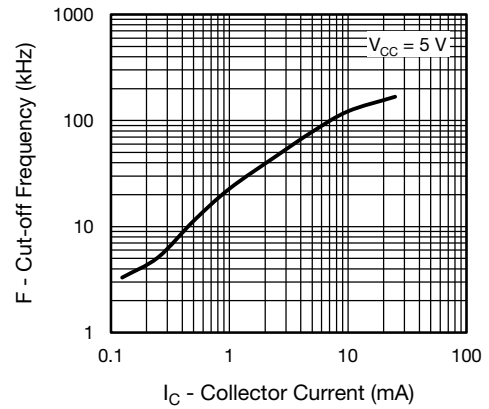


Fig. 15 - Frequency vs. Collector Current

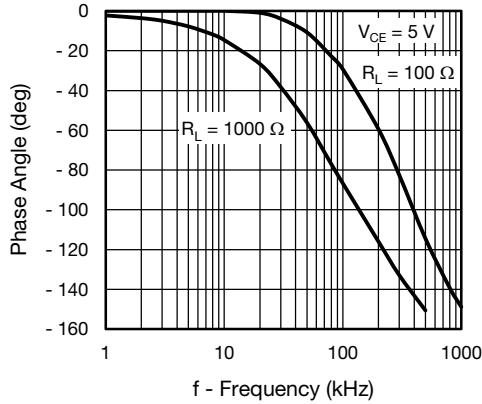


Fig. 14 - Frequency vs. Phase Angle

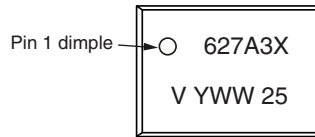


Fig. 16 - Switching Time vs. Load Resistance

**PACKAGE DIMENSIONS** in millimeters



**PACKAGE MARKING** (example of VOS627A-3X001T)



**Notes**

- Option 1 is reflected with letter “X”.
- Tape and reel suffix (T) is not part of the package marking.
- VOS627AT can be marked as 627A1, 627A2, 627A3, or 627A4.
- VOS627A-X001T can be marked as 627A1X, 627A2X, 627A3X, or 627A4X.

**TAPE AND REEL DIMENSIONS** in millimeters

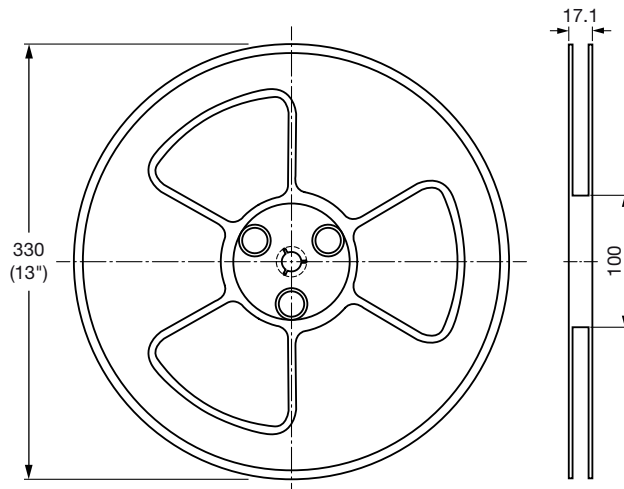


Fig. 17 - Reel Dimensions (3000 units per reel)



Fig. 18 - Tape Dimensions



## Disclaimer

ALL PRODUCT, PRODUCT SPECIFICATIONS AND DATA ARE SUBJECT TO CHANGE WITHOUT NOTICE TO IMPROVE RELIABILITY, FUNCTION OR DESIGN OR OTHERWISE.

Vishay Intertechnology, Inc., its affiliates, agents, and employees, and all persons acting on its or their behalf (collectively, "Vishay"), disclaim any and all liability for any errors, inaccuracies or incompleteness contained in any datasheet or in any other disclosure relating to any product.

Vishay makes no warranty, representation or guarantee regarding the suitability of the products for any particular purpose or the continuing production of any product. To the maximum extent permitted by applicable law, Vishay disclaims (i) any and all liability arising out of the application or use of any product, (ii) any and all liability, including without limitation special, consequential or incidental damages, and (iii) any and all implied warranties, including warranties of fitness for particular purpose, non-infringement and merchantability.

Statements regarding the suitability of products for certain types of applications are based on Vishay's knowledge of typical requirements that are often placed on Vishay products in generic applications. Such statements are not binding statements about the suitability of products for a particular application. It is the customer's responsibility to validate that a particular product with the properties described in the product specification is suitable for use in a particular application. Parameters provided in datasheets and / or specifications may vary in different applications and performance may vary over time. All operating parameters, including typical parameters, must be validated for each customer application by the customer's technical experts. Product specifications do not expand or otherwise modify Vishay's terms and conditions of purchase, including but not limited to the warranty expressed therein.

Hyperlinks included in this datasheet may direct users to third-party websites. These links are provided as a convenience and for informational purposes only. Inclusion of these hyperlinks does not constitute an endorsement or an approval by Vishay of any of the products, services or opinions of the corporation, organization or individual associated with the third-party website. Vishay disclaims any and all liability and bears no responsibility for the accuracy, legality or content of the third-party website or for that of subsequent links.

Except as expressly indicated in writing, Vishay products are not designed for use in medical, life-saving, or life-sustaining applications or for any other application in which the failure of the Vishay product could result in personal injury or death. Customers using or selling Vishay products not expressly indicated for use in such applications do so at their own risk. Please contact authorized Vishay personnel to obtain written terms and conditions regarding products designed for such applications.

No license, express or implied, by estoppel or otherwise, to any intellectual property rights is granted by this document or by any conduct of Vishay. Product names and markings noted herein may be trademarks of their respective owners.

## Looking for pricing, stock, or lifecycle information?

Click below to explore more details on WIN SOURCE:

 [View VOS627A-2X001T on WIN SOURCE](#)

 [Vishay Information](#)

## Optimize Your Supply Chain with WIN SOURCE Solutions

-  Global Sourcing Solution
-  Obsolete Management
-  Cost Control Management
-  Shortage Management
-  Alternative Solution
-  Excess Inventory Management