

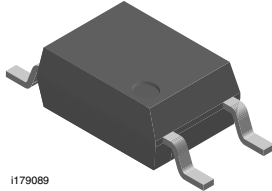

**THE DATASHEET OF
VOM617A-4X001T**



Low Input Current, Phototransistor Output, SOP-4, Mini-Flat Package



1179089

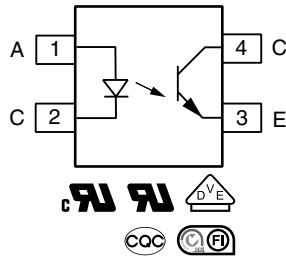

LINKS TO ADDITIONAL RESOURCES



DESCRIPTION

The 110 °C rated VOM617A has a GaAs infrared emitting diode emitter, which is optically coupled to a silicon planar phototransistor detector, and is incorporated in a 4 pin 100 mil lead pitch miniflat package. It features a high current transfer ratio, low coupling capacitance, and high isolation voltage.

These coupling devices are designed for signal transmission between two electrically separated circuits.

FEATURES

- Operating temperature from -55 °C to +110 °C
- SOP-4 mini-flat package
- Isolation test voltage, 3750 V_{RMS}
- Low saturation voltage
- Fast switching times
- Low coupling capacitance
- End-stackable, 0.100" (2.54 mm) spacing
- CTR range 50 % to 600 %, I_F = 5 mA
- Material categorization: for definitions of compliance please see www.vishay.com/doc?99912



APPLICATIONS

- PLCs
- Telecommunication
- Lighting control system
- Solar inverters
- AC drives

AGENCY APPROVALS

(All parts are certified under base model VOM617A)

- [UL1577](#)
- [cUL](#)
- [DIN EN 60747-5-5 \(VDE 0884-5\)](#), available with option 1
- [CQC](#)
- [FIMKO](#)

ORDERING INFORMATION																																						
<div style="display: flex; justify-content: space-around; align-items: center;"> <div style="text-align: center;"> <table border="1" style="border-collapse: collapse;"> <tr> <td>V</td><td>O</td><td>M</td><td>6</td><td>1</td><td>7</td><td>A</td><td>-</td><td>#</td><td>X</td><td>0</td><td>0</td><td>1</td><td>T</td><td>#</td> </tr> <tr> <td colspan="7">PART NUMBER</td> <td>CTR BIN</td> <td colspan="4">VDE OPTION</td> <td colspan="2">TAPE AND REEL</td> </tr> </table> </div> <div style="text-align: center;"> <p>SOP-4 ≥ 5</p> </div> </div>										V	O	M	6	1	7	A	-	#	X	0	0	1	T	#	PART NUMBER							CTR BIN	VDE OPTION				TAPE AND REEL	
V	O	M	6	1	7	A	-	#	X	0	0	1	T	#																								
PART NUMBER							CTR BIN	VDE OPTION				TAPE AND REEL																										
AGENCY CERTIFIED/ PACKAGE	CTR (%)																																					
	5 mA																																					
UL, cUL, FIMKO, CQC	50 to 600	63 to 125	100 to 200	160 to 320	250 to 500	80 to 160	130 to 260	200 to 400																														
SOP-4, mini-flat	VOM617AT	VOM617A-2T	VOM617A-3T	VOM617A-4T	VOM617A-6T	VOM617A-7T	VOM617A-8T	VOM617A-9T																														
VDE, UL, cUL, FIMKO, CQC (option 1)	50 to 600	63 to 125	100 to 200	160 to 320	250 to 500	80 to 160	130 to 260	200 to 400																														
SOP-4, mini-flat	VOM617A-X001T	VOM617A-2X001T	VOM617A-3X001T	VOM617A-4X001T	VOM617A-6X001T	VOM617A-7X001T	VOM617A-8X001T, VOM617A-8X001T2 ⁽¹⁾	VOM617A-9X001T																														

Notes

- Available only on tape and reel
- (1) Product is rotated 180° in tape and reel cavity



ABSOLUTE MAXIMUM RATINGS (T _{amb} = 25 °C, unless otherwise specified)				
PARAMETER	TEST CONDITION	SYMBOL	VALUE	UNIT
INPUT				
DC forward current		I _F	60	mA
Reverse voltage		V _R	6	V
Power dissipation		P _{diss}	70	mW
Surge forward current	t _p ≤ 10 μs	I _{FSM}	2.5	A
OUTPUT				
Collector emitter voltage		V _{CEO}	80	V
Emitter collector voltage		V _{ECO}	7	V
Collector current		I _C	50	mA
	t _p ≤ 1 ms		100	mA
Power dissipation		P _{diss}	150	mW
COUPLER				
Total power dissipation		P _{tot}	170	mW
Operating temperature range		T _{amb}	-55 to +110	°C
Storage temperature range		T _{stg}	-55 to +150	°C
Junction temperature		T _j	125	°C
Soldering temperature ⁽¹⁾		T _{slid}	260	°C

Notes

- Stresses in excess of the absolute maximum ratings can cause permanent damage to the device. Functional operation of the device is not implied at these or any other conditions in excess of those given in the operational sections of this document. Exposure to absolute maximum ratings for extended periods of the time can adversely affect reliability
- See "Assembly Instructions" for surface mounted devices (www.vishay.com/doc?80054)

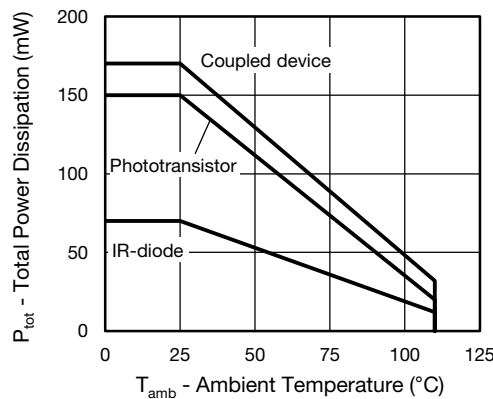

Fig. 1 - Total Power Dissipation vs. Ambient Temperature



ELECTRICAL CHARACTERISTICS ($T_{amb} = 25\text{ }^{\circ}\text{C}$, unless otherwise specified)						
PARAMETER	TEST CONDITION	SYMBOL	MIN.	TYP.	MAX.	UNIT
INPUT						
Forward voltage	$I_F = 5\text{ mA}$	V_F	-	1.1	1.6	V
Reverse current	$V_R = 6\text{ V}$	I_R	-	0.01	10	μA
Capacitance	$V_R = 0\text{ V}, f = 1\text{ MHz}$	C_j	-	9	-	pF
OUTPUT						
Collector emitter leakage current	$V_{CE} = 20\text{ V}$	I_{CEO}	-	0.3	100	nA
Collector emitter breakdown voltage	$I_C = 100\text{ }\mu\text{A}$	BV_{CEO}	80	-	-	V
Emitter collector breakdown voltage	$I_E = 10\text{ }\mu\text{A}$	BV_{ECO}	7	-	-	V
Collector emitter capacitance	$V_{CE} = 5\text{ V}, f = 1\text{ MHz}$	C_{CE}	-	2.8	-	pF
COUPLER						
Coupling capacitance	$f = 1\text{ MHz}$	C_{IO}	-	0.3	-	pF
Collector emitter saturation voltage	$I_F = 10\text{ mA}, I_C = 2.5\text{ mA}$	V_{CEsat}	-	0.12	0.4	V
Cut-off frequency	$I_F = 10\text{ mA}, V_{CC} = 5\text{ V}, R_L = 100\text{ }\Omega$	f_{ctr}	-	110	-	kHz

Note

- Minimum and maximum values are testing requirements. Typical values are characteristics of the device and are the result of engineering evaluation. Typical values are for information only and are not part of the testing requirements

CURRENT TRANSFER RATIO ($T_{amb} = 25\text{ }^{\circ}\text{C}$, unless otherwise specified)							
PARAMETER	TEST CONDITION	PART	SYMBOL	MIN.	TYP.	MAX.	UNIT
I_C/I_F	$I_F = 5\text{ mA}, V_{CE} = 5\text{ V}$	VOM617A	CTR	50	-	600	%
		VOM617A-2	CTR	63	-	125	%
		VOM617A-3	CTR	100	-	200	%
		VOM617A-4	CTR	160	-	320	%
		VOM617A-6	CTR	250	-	500	%
		VOM617A-7	CTR	80	-	160	%
		VOM617A-8	CTR	130	-	260	%
		VOM617A-9	CTR	200	-	400	%

SWITCHING CHARACTERISTICS ($T_{amb} = 25\text{ }^{\circ}\text{C}$, unless otherwise specified)						
PARAMETER	TEST CONDITION	SYMBOL	MIN.	TYP.	MAX.	UNIT
NON-SATURATED						
Rise and fall time	$I_C = 2\text{ mA}, V_{CC} = 5\text{ V}, R_L = 100\text{ }\Omega$	t_r	-	3	-	μs
Fall time		t_f	-	3	-	μs
Turn-on time		t_{on}	-	6	-	μs
Turn-off time		t_{off}	-	4	-	μs
SATURATED						
Rise and fall time	$I_F = 1.6\text{ mA}, V_{CC} = 5\text{ V}, R_L = 1.9\text{ k}\Omega$	t_r	-	7	-	μs
Fall time		t_f	-	12	-	μs
Turn-on time		t_{on}	-	9	-	μs
Turn-off time		t_{off}	-	15	-	μs

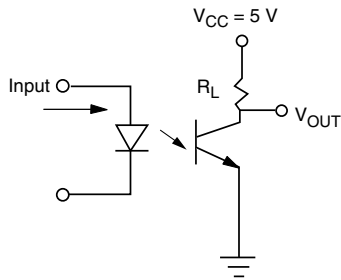

Fig. 2 - Test Circuit

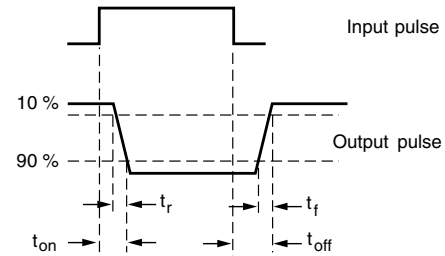

Fig. 3 - Test Circuit and Waveforms

SAFETY AND INSULATION RATINGS				
PARAMETER	TEST CONDITION	SYMBOL	VALUE	UNIT
Climatic classification	According to IEC 68 part 1		55 / 110 / 21	
Pollution degree	According to DIN VDE 0109		2	
Comparative tracking index		CTI	175	
Maximum rated withstanding isolation voltage	According to UL1577, t = 1 min	V_{ISO}	3750	V_{RMS}
Maximum transient isolation voltage	According to DIN EN 60747-5-5	V_{IOTM}	6000	V_{peak}
Maximum repetitive peak isolation voltage	According to DIN EN 60747-5-5	$V_{IO RM}$	565	V_{peak}
Isolation resistance	$V_{IO} = 500 \text{ V}$, $T_{amb} = 25 \text{ }^\circ\text{C}$	R_{IO}	$\geq 10^{12}$	Ω
	$V_{IO} = 500 \text{ V}$, $T_{amb} = 100 \text{ }^\circ\text{C}$	R_{IO}	$\geq 10^{11}$	Ω
Output safety power		P_{SO}	300	mW
Input safety current		I_{SI}	200	mA
Input safety temperature		T_S	175	$^\circ\text{C}$
Creepage distance			≥ 5	mm
Clearance distance			≥ 5	mm
Insulation thickness		DTI	≥ 0.4	mm

Note

- As per DIN EN 60747-5-5 (VDE 0884), § 7.4.3.8.2, this optocoupler is suitable for “safe electrical insulation” only within the safety ratings. Compliance with the safety ratings shall be ensured by means of protective circuits

TYPICAL CHARACTERISTICS ($T_{amb} = 25\text{ }^{\circ}\text{C}$, unless otherwise specified)

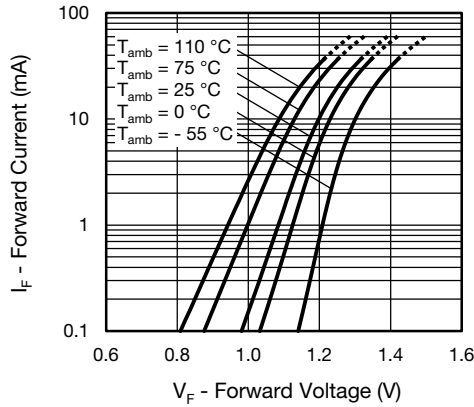

Fig. 4 - Forward Voltage vs. Forward Current

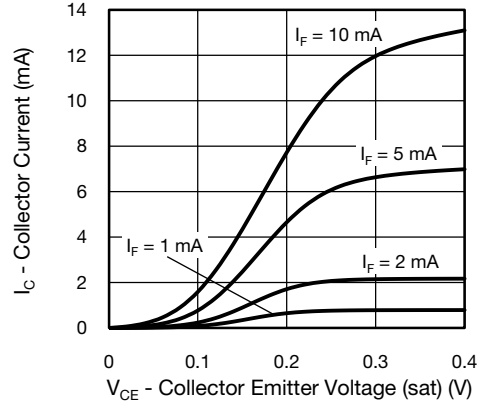

Fig. 7 - Collector Current vs. Collector Emitter Voltage (saturated)

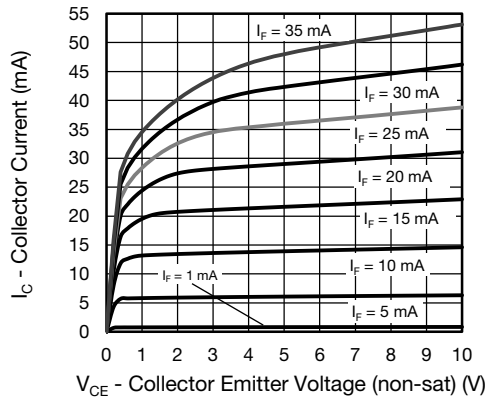

Fig. 5 - Collector Current vs. Collector Emitter Voltage (non-saturated)

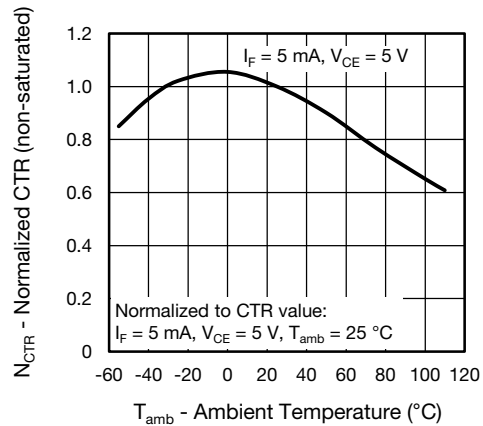

Fig. 8 - Normalized Current Transfer Ratio (non-saturated) vs. Ambient Temperature

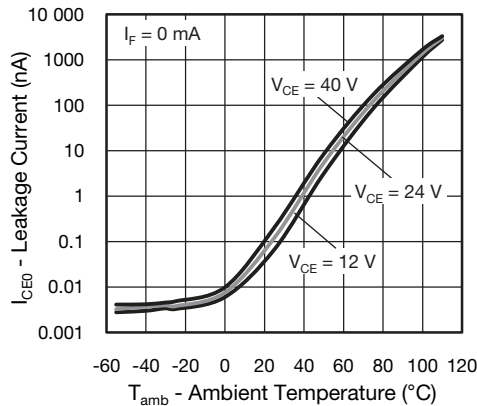

Fig. 6 - Leakage Current vs. Ambient Temperature

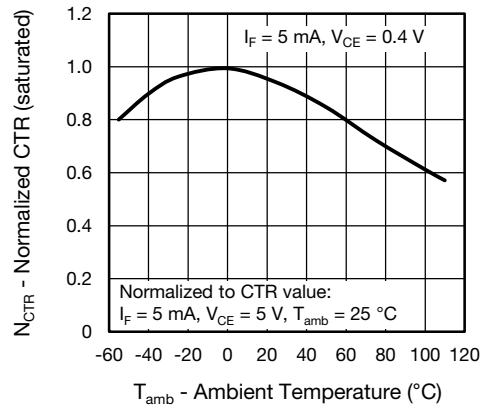

Fig. 9 - Normalized Current Transfer Ratio (saturated) vs. Ambient Temperature

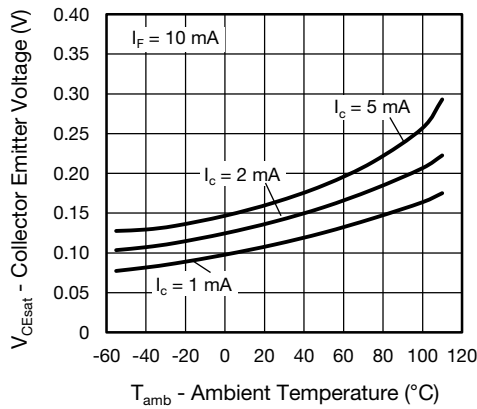

Fig. 10 - Collector Emitter Voltage vs. Ambient Temperature (saturated)

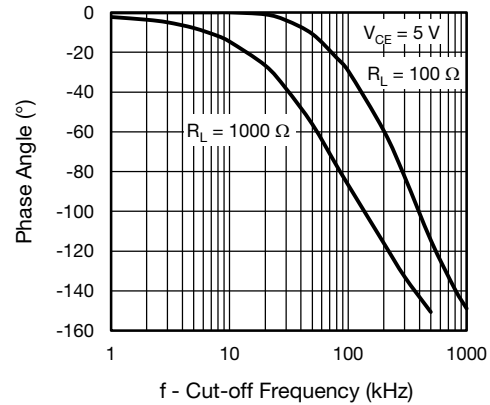

Fig. 13 - F_{CTR} vs. Phase Angle

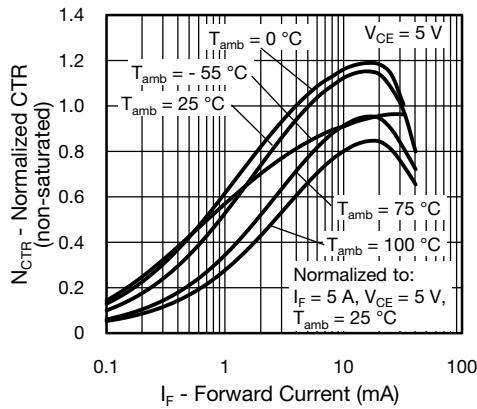

Fig. 11 - Normalized CTR (non-saturated) vs. Forward Current

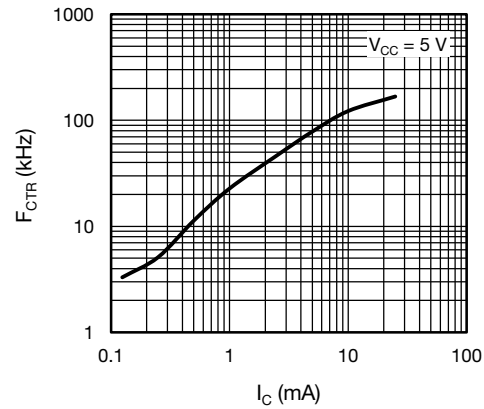

Fig. 14 - F_{CTR} vs. Collector Current

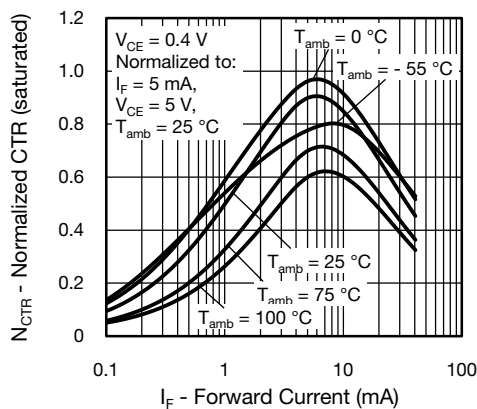

Fig. 12 - Normalized CTR (saturated) vs. Forward Current

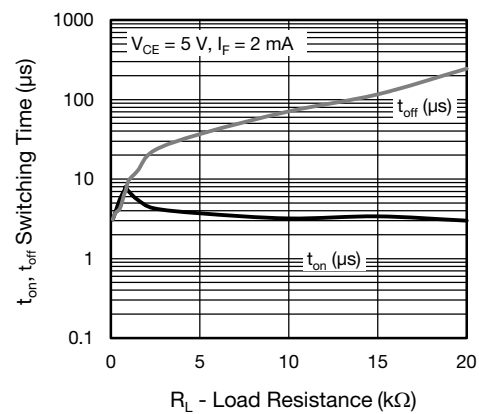
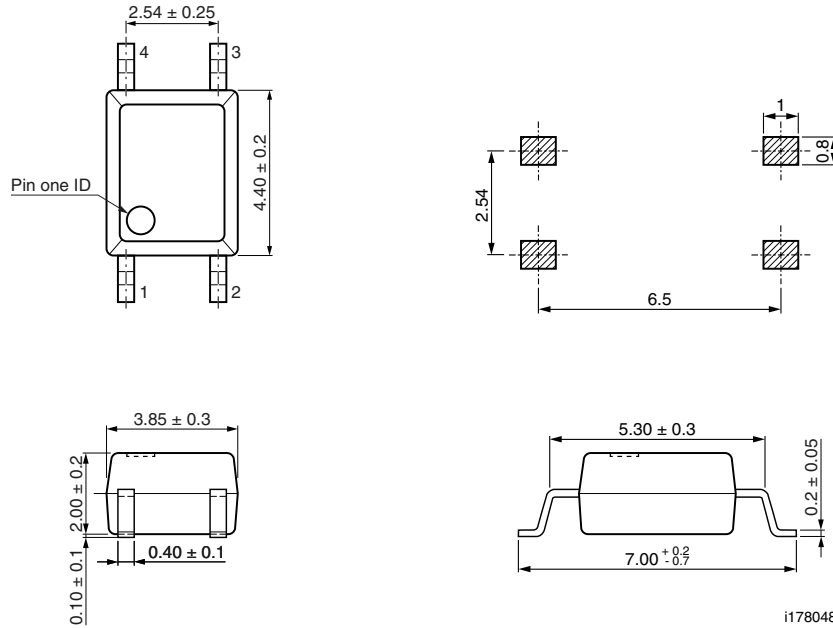
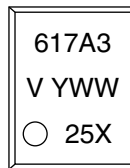

Fig. 15 - Switching Time vs. Load Resistance

PACKAGE DIMENSIONS in millimeters



PACKAGE MARKING (example of VOM617A-3X001T)



Notes

- Only option 1 is reflected in the package marking with the characters “X”
- Tape and reel suffix (T) is not part of the package marking

TAPE AND REEL DIMENSIONS in millimeters

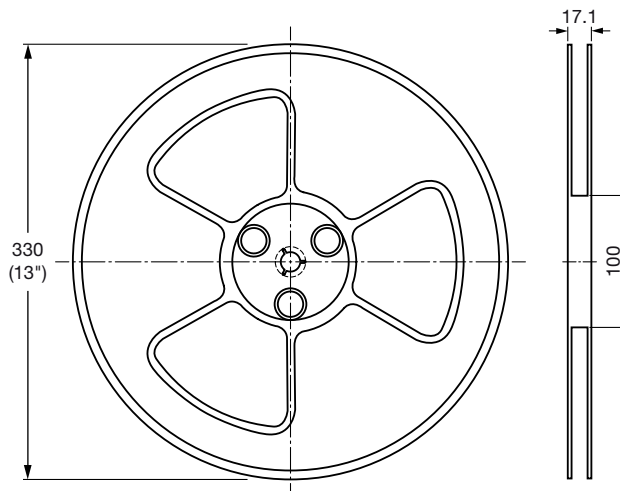

Fig. 16 - Reel Dimensions (3000 units per reel)

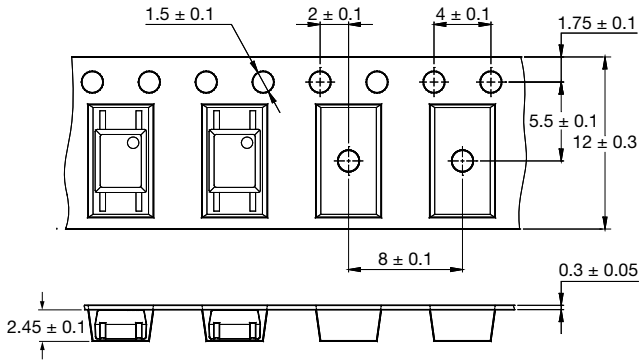

Fig. 17 - Tape Dimensions

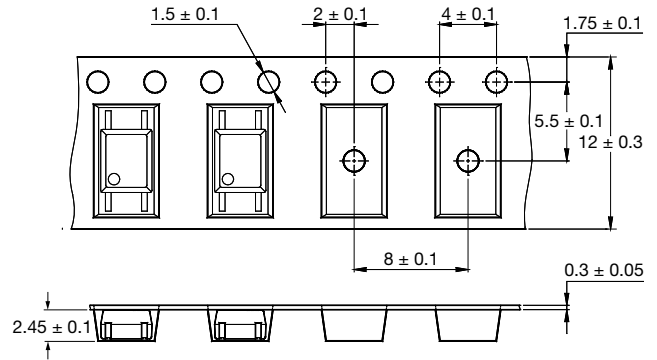

Fig. 18 - Tape Dimensions for 180° Rotation (T2)

SOLDER PROFILE

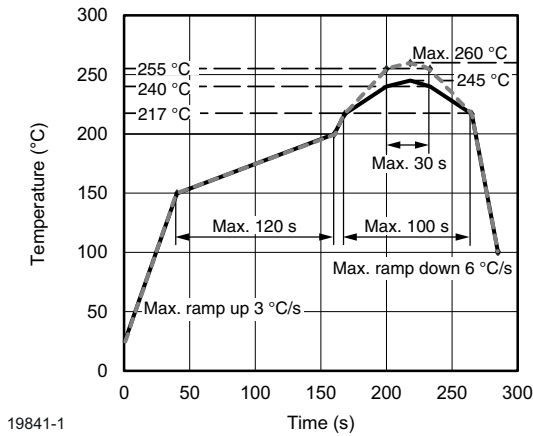

Fig. 19 - Lead (Pb)-free Reflow Solder Profile According to J-STD-020

HANDLING AND STORAGE CONDITIONS

ESD level: HBM class 2

Floor life: unlimited

Conditions: $T_{amb} < 30\text{ }^{\circ}\text{C}$, RH < 85 %

Moisture sensitivity level 1, according to J-STD-020



Disclaimer

ALL PRODUCT, PRODUCT SPECIFICATIONS AND DATA ARE SUBJECT TO CHANGE WITHOUT NOTICE TO IMPROVE RELIABILITY, FUNCTION OR DESIGN OR OTHERWISE.

Vishay Intertechnology, Inc., its affiliates, agents, and employees, and all persons acting on its or their behalf (collectively, "Vishay"), disclaim any and all liability for any errors, inaccuracies or incompleteness contained in any datasheet or in any other disclosure relating to any product.

Vishay makes no warranty, representation or guarantee regarding the suitability of the products for any particular purpose or the continuing production of any product. To the maximum extent permitted by applicable law, Vishay disclaims (i) any and all liability arising out of the application or use of any product, (ii) any and all liability, including without limitation special, consequential or incidental damages, and (iii) any and all implied warranties, including warranties of fitness for particular purpose, non-infringement and merchantability.

Statements regarding the suitability of products for certain types of applications are based on Vishay's knowledge of typical requirements that are often placed on Vishay products in generic applications. Such statements are not binding statements about the suitability of products for a particular application. It is the customer's responsibility to validate that a particular product with the properties described in the product specification is suitable for use in a particular application. Parameters provided in datasheets and / or specifications may vary in different applications and performance may vary over time. All operating parameters, including typical parameters, must be validated for each customer application by the customer's technical experts. Product specifications do not expand or otherwise modify Vishay's terms and conditions of purchase, including but not limited to the warranty expressed therein.

Hyperlinks included in this datasheet may direct users to third-party websites. These links are provided as a convenience and for informational purposes only. Inclusion of these hyperlinks does not constitute an endorsement or an approval by Vishay of any of the products, services or opinions of the corporation, organization or individual associated with the third-party website. Vishay disclaims any and all liability and bears no responsibility for the accuracy, legality or content of the third-party website or for that of subsequent links.

Except as expressly indicated in writing, Vishay products are not designed for use in medical, life-saving, or life-sustaining applications or for any other application in which the failure of the Vishay product could result in personal injury or death. Customers using or selling Vishay products not expressly indicated for use in such applications do so at their own risk. Please contact authorized Vishay personnel to obtain written terms and conditions regarding products designed for such applications.

No license, express or implied, by estoppel or otherwise, to any intellectual property rights is granted by this document or by any conduct of Vishay. Product names and markings noted herein may be trademarks of their respective owners.

Looking for pricing, stock, or lifecycle information?

Click below to explore more details on WIN SOURCE:

 [View VOM617A-4X001T on WIN SOURCE](#)

 [Vishay Information](#)

Optimize Your Supply Chain with WIN SOURCE Solutions

-  Global Sourcing Solution
-  Obsolete Management
-  Cost Control Management
-  Shortage Management
-  Alternative Solution
-  Excess Inventory Management