

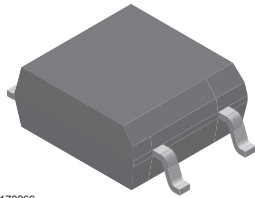

THE DATASHEET OF VOM160RT



Optocoupler, Phototriac Output, Non-Zero Crossing, 0.5 kV/μs dV/dt, 600 V



I179066

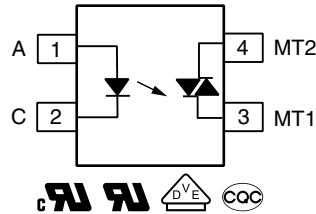

FEATURES

- High static dV/dt > 0.5 kV/μs
- Input sensitivity $I_{FT} = 5 \text{ mA}$, 7 mA, and 10 mA
- On-state RMS current $I_{T(RMS)} = 70 \text{ mA}$
- 600 V peak off-state blocking voltage
- Isolation test voltage 3750 V_{RMS}
- Material categorization: for definitions of compliance please see www.vishay.com/doc?99912



LINKS TO ADDITIONAL RESOURCES



DESCRIPTION

The VOM160 series phototriac consist a AlGaAs infrared emitting diode (IRED) optically coupled to a photosensitive non-zero crossing TRIAC packaged in a SOP-4 package. It has a IRED trigger current of 5 mA, 7 mA, and 10 mA.

The VOM160 series phototriac isolate low-voltage logic from 120 V_{AC}, 240 V_{AC}, and 380 V_{AC} lines to control resistive, inductive, or capacitive loads including motors, solenoids, high current thyristors or TRIAC and relays.

APPLICATIONS

- Consumer appliances
- Triac drives
- Solid-state relays
- Motor controls
- Office equipment

AGENCY APPROVALS

- [UL 1577](#)
- [cUL](#)
- [DIN EN 60747-5-5 \(VDE 0884-5\)](#), available with option 1
- [CQC](#)

| ORDERING INFORMATION | | | |
|---|--------------------------|----------|----------|
| <div style="display: flex; justify-content: space-around; align-items: center;"> <div style="border: 1px solid black; padding: 2px 5px; margin: 2px;">V</div> <div style="border: 1px solid black; padding: 2px 5px; margin: 2px;">O</div> <div style="border: 1px solid black; padding: 2px 5px; margin: 2px;">M</div> <div style="border: 1px solid black; padding: 2px 5px; margin: 2px;">1</div> <div style="border: 1px solid black; padding: 2px 5px; margin: 2px;">6</div> <div style="border: 1px solid black; padding: 2px 5px; margin: 2px;">0</div> <div style="border: 1px solid black; padding: 2px 5px; margin: 2px;">X</div> <div style="border: 1px solid black; padding: 2px 5px; margin: 2px;">T</div> </div> <p style="text-align: center; margin-top: 5px;">PART NUMBER</p> | | | |
| | | | |
| AGENCY CERTIFIED / PACKAGE | TRIGGER CURRENT I_{FT} | | |
| UL, cUL, CQC | 5 mA | 7 mA | 10 mA |
| SOP-4 | VOM160NT | VOM160PT | VOM160RT |
| UL, cUL, CQC, VDE (option 1) | 5 mA | 7 mA | 10 mA |
| SOP-4 | VOM160N-X001T | - | - |

Notes

- For additional information on the available options refer to option information
- The product is available only on tape and reel

| ABSOLUTE MAXIMUM RATINGS ($T_{amb} = 25\text{ }^{\circ}\text{C}$, unless otherwise specified) | | | | | |
|--|-----------------------------|------|--------------|-------------|--------------------|
| PARAMETER | TEST CONDITION | PART | SYMBOL | VALUE | UNIT |
| INPUT | | | | | |
| Reverse voltage | | | V_R | 6 | V |
| Forward current | | | I_F | 60 | mA |
| Peak surge current | 100 μs , 200 pps | | I_{FSM} | 0.5 | A |
| Power dissipation | | | P_{diss} | 100 | mW |
| OUTPUT | | | | | |
| Peak off-state voltage | | | V_{DRM} | 600 | V |
| RMS on-state current | | | $I_{T(RMS)}$ | 70 | mA |
| Peak non-repetitive surge current | PW = 100 ms, 120 pps | | I_{TSM} | 1 | A |
| Power dissipation | | | P_{diss} | 200 | mW |
| COUPLER | | | | | |
| Isolation test voltage | t = 1 min | | V_{ISO} | 3750 | V_{RMS} |
| Power dissipation | | | P_{tot} | 300 | mW |
| Storage temperature range | | | T_{stg} | -55 to +150 | $^{\circ}\text{C}$ |
| Ambient temperature range | | | T_{amb} | -40 to +100 | $^{\circ}\text{C}$ |
| Soldering temperature ⁽¹⁾ | | | T_{sld} | 260 | $^{\circ}\text{C}$ |

Notes

- Stresses in excess of the Absolute Maximum Ratings can cause permanent damage to the device. Functional operation of the device is not implied at these or any other conditions in excess of those given in the operational sections of this document. Exposure to Absolute Maximum Ratings for extended periods of the time can adversely affect reliability.
- ⁽¹⁾ Wave soldering three cycles are allowed. Also refer to "Assembly Instructions" for surface mounted devices (www.vishay.com/doc?80054).

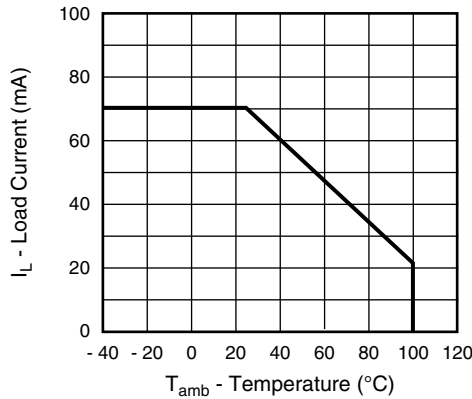

Fig. 1 - Recommended Operating Condition



| ELECTRICAL CHARACTERISTICS ($T_{amb} = 25\text{ }^{\circ}\text{C}$, unless otherwise specified) | | | | | | | |
|--|---|---------|---------------|------|------|------|------------------|
| PARAMETER | TEST CONDITION | PART | SYMBOL | MIN. | TYP. | MAX. | UNIT |
| INPUT | | | | | | | |
| Forward voltage | $I_F = 10\text{ mA}$ | | V_F | | 1.2 | 1.5 | V |
| Reverse current | $V_R = 6\text{ V}$ | | I_R | | | 10 | μA |
| Input capacitance | $V_F = 0\text{ V}$, $f = 1\text{ MHz}$ | | C_I | | 25 | | pF |
| OUTPUT | | | | | | | |
| Off-state current | $V_D = V_{DRM}$ | | I_{DRM} | | | 100 | nA |
| On-state voltage | $I_T = 100\text{ mA}$ | | V_{TM} | | | 2.8 | V |
| Critical rate of rise off-state voltage | $V_D = 0.67 V_{DRM}$, $T_J = 25\text{ }^{\circ}\text{C}$ | | dV/dt_{cr} | 500 | | | V/ μs |
| Critical rate of rise of voltage at current commutation | | | dV/dt_{crq} | | 0.13 | | V/ μs |
| COUPLER | | | | | | | |
| LED trigger current, current required to latch output | $V_D = 3\text{ V}$ | VOM160N | I_{FT} | | | 5 | mA |
| | | VOM160P | I_{FT} | | | 7 | mA |
| | | VOM160R | I_{FT} | | | 10 | mA |
| Capacitance (input - output) | $f = 1\text{ MHz}$, $V_{IO} = 0\text{ V}$ | | C_{IO} | | 0.8 | | pF |
| Peak off-state voltage | $I_C = 100\text{ }\mu\text{A}$ | | V_{DRM} | 600 | | | V |
| Holding current | | | I_{hold} | | 0.3 | | mA |

Note

- Minimum and maximum values were tested requirements. Typical values are characteristics of the device and are the result of engineering evaluations. Typical values are for information only and are not part of the testing requirements.

| SAFETY AND INSULATION RATINGS | | | | | | |
|---|------------|-----------|-----------|------|--------------------|--|
| PARAMETER | SYMBOL | MIN. | TYP. | MAX. | UNIT | |
| Climatic classification (according to IEC 68 part 1) | | | 40/100/21 | | | |
| Pollution degree (DIN VDE 0109) | | | 2 | | | |
| Comparative tracking index | CTI | 175 | | 399 | | |
| Peak transient overvoltage | V_{IOTM} | | | 6000 | V_{peak} | |
| Peak insulation voltage | V_{IORM} | | | 707 | V_{peak} | |
| Isolation resistance at $T_{amb} = 100\text{ }^{\circ}\text{C}$, $V_{DC} = 500\text{ V}$ | R_{IO} | 10^{11} | | | Ω | |
| Isolation resistance at $T_{amb} = 25\text{ }^{\circ}\text{C}$, $V_{DC} = 500\text{ V}$ | R_{IO} | 10^{12} | | | Ω | |
| Safety rating - power rating | P_{SO} | | | 400 | mW | |
| Safety rating - input current | I_{SI} | | | 150 | mA | |
| Safety rating - temperature | T_{SI} | | | 165 | $^{\circ}\text{C}$ | |
| Creepage distance | | 5 | | | mm | |
| Clearance distance | | 5 | | | mm | |
| Insulation thickness | | 0.4 | | | mm | |

TYPICAL CHARACTERISTICS ($T_{amb} = 25\text{ }^{\circ}\text{C}$, unless otherwise specified)

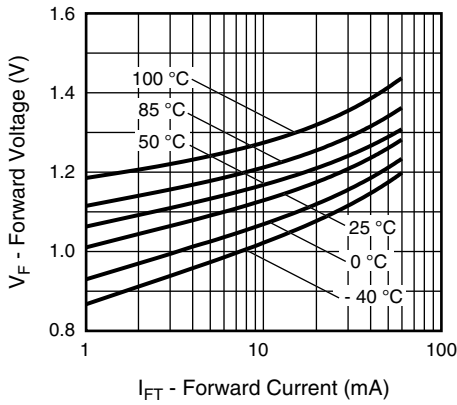

Fig. 2 - Forward Current vs. Forward Voltage

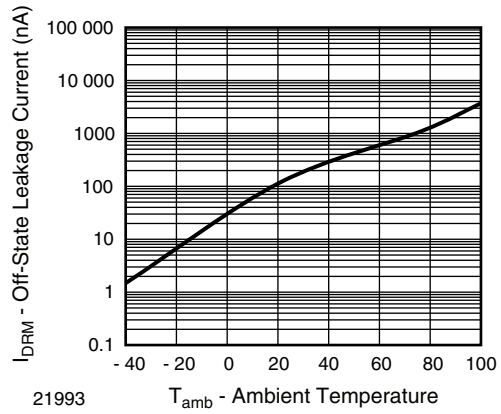

Fig. 5 - Off-State Leakage Current vs. Ambient Temperature

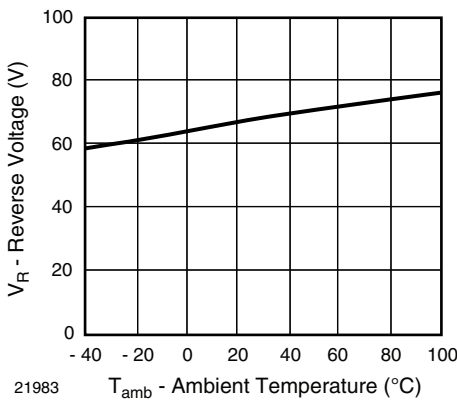

Fig. 3 - Reverse Voltage vs. Ambient Temperature

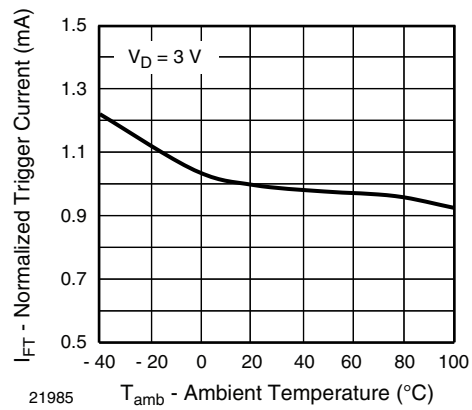

Fig. 6 - Normalized Trigger Current vs. Ambient Temperature

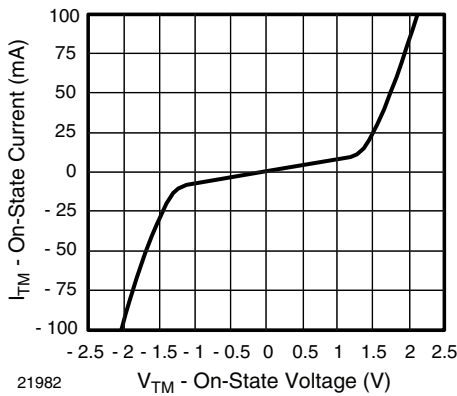

Fig. 4 - On-State Current vs. On-State Voltage

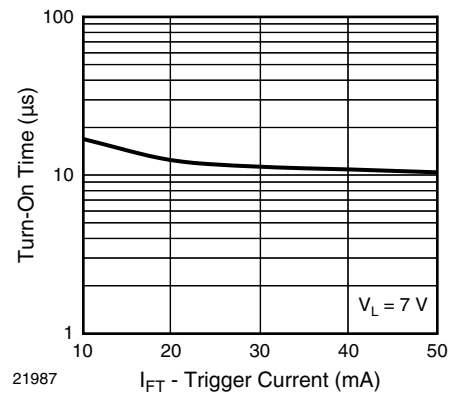

Fig. 7 - Trigger Current vs. Turn-On Time

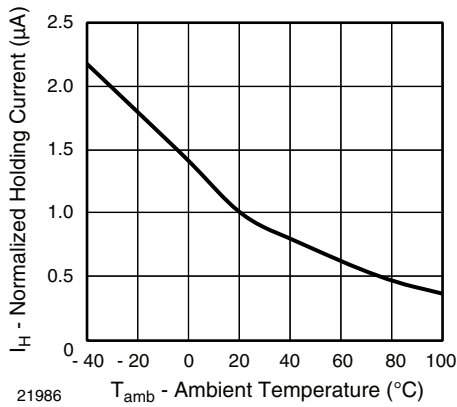

Fig. 8 - Normalized Holding Current vs. Ambient Temperature

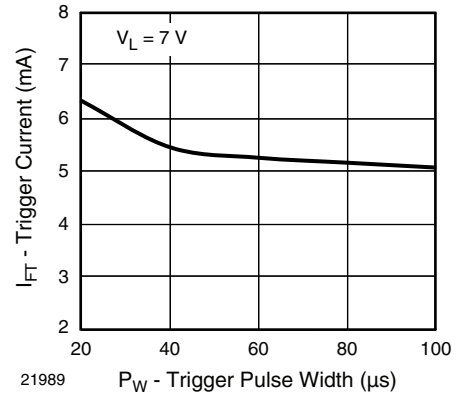

Fig. 10 - Trigger Current vs. Trigger Pulse Width

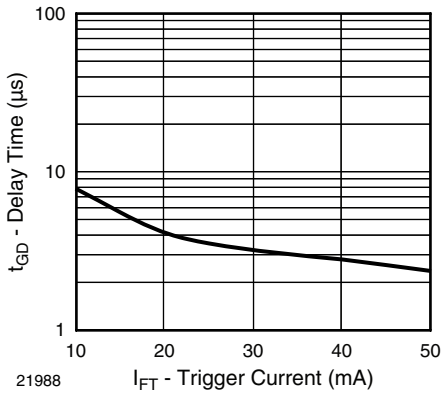

Fig. 9 - Trigger Current vs. Delay Time

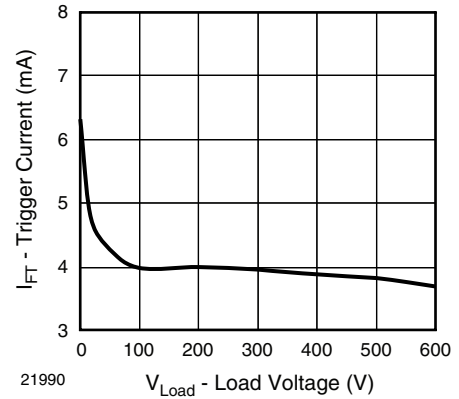
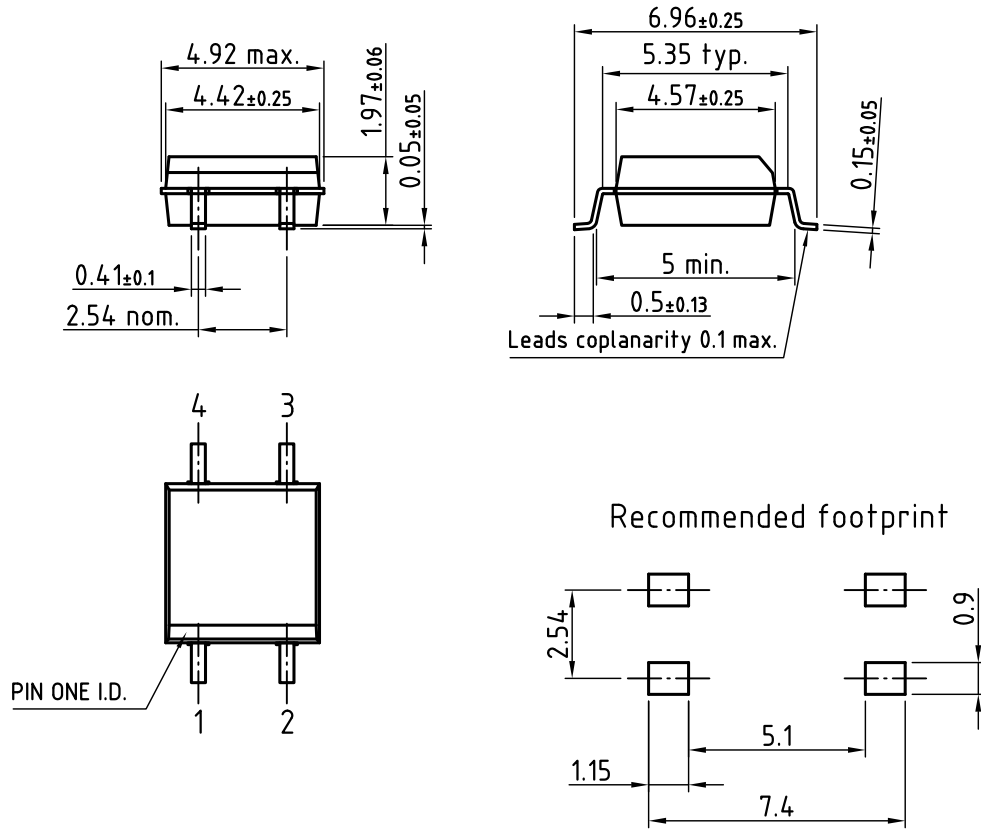

Fig. 11 - Trigger Current vs. Load Voltage

PACKAGE DIMENSIONS in millimeters



PACKAGE MARKING

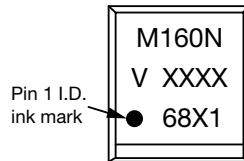

Fig. 12 - Example of VOM160N-X001T

Notes

- XXXX = LMC (lot marking code)
- VDE marking "X1" is only marked on "option 1" parts
- Tape and reel suffix (T) is not part of the package marking

TAPE AND REEL PACKAGING (in millimeters)

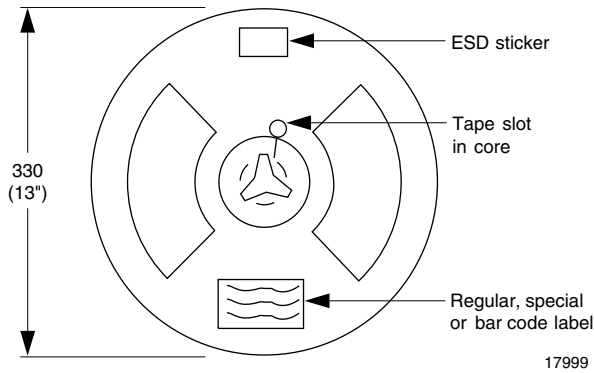

Fig. 13 - Tape and Reel Shipping Medium, 2000 units per reel

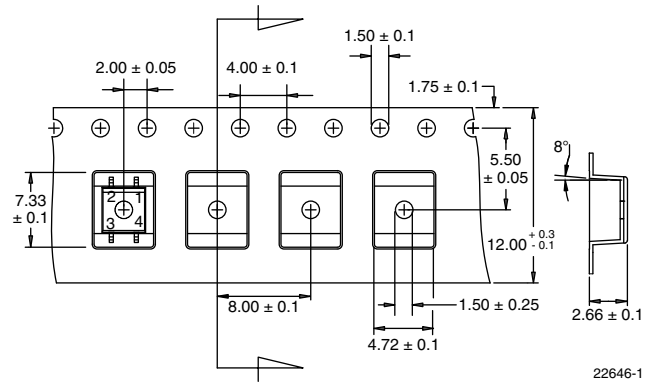

Fig. 14 - Tape Dimensions



Disclaimer

ALL PRODUCT, PRODUCT SPECIFICATIONS AND DATA ARE SUBJECT TO CHANGE WITHOUT NOTICE TO IMPROVE RELIABILITY, FUNCTION OR DESIGN OR OTHERWISE.

Vishay Intertechnology, Inc., its affiliates, agents, and employees, and all persons acting on its or their behalf (collectively, "Vishay"), disclaim any and all liability for any errors, inaccuracies or incompleteness contained in any datasheet or in any other disclosure relating to any product.

Vishay makes no warranty, representation or guarantee regarding the suitability of the products for any particular purpose or the continuing production of any product. To the maximum extent permitted by applicable law, Vishay disclaims (i) any and all liability arising out of the application or use of any product, (ii) any and all liability, including without limitation special, consequential or incidental damages, and (iii) any and all implied warranties, including warranties of fitness for particular purpose, non-infringement and merchantability.

Statements regarding the suitability of products for certain types of applications are based on Vishay's knowledge of typical requirements that are often placed on Vishay products in generic applications. Such statements are not binding statements about the suitability of products for a particular application. It is the customer's responsibility to validate that a particular product with the properties described in the product specification is suitable for use in a particular application. Parameters provided in datasheets and / or specifications may vary in different applications and performance may vary over time. All operating parameters, including typical parameters, must be validated for each customer application by the customer's technical experts. Product specifications do not expand or otherwise modify Vishay's terms and conditions of purchase, including but not limited to the warranty expressed therein.

Hyperlinks included in this datasheet may direct users to third-party websites. These links are provided as a convenience and for informational purposes only. Inclusion of these hyperlinks does not constitute an endorsement or an approval by Vishay of any of the products, services or opinions of the corporation, organization or individual associated with the third-party website. Vishay disclaims any and all liability and bears no responsibility for the accuracy, legality or content of the third-party website or for that of subsequent links.

Except as expressly indicated in writing, Vishay products are not designed for use in medical, life-saving, or life-sustaining applications or for any other application in which the failure of the Vishay product could result in personal injury or death. Customers using or selling Vishay products not expressly indicated for use in such applications do so at their own risk. Please contact authorized Vishay personnel to obtain written terms and conditions regarding products designed for such applications.

No license, express or implied, by estoppel or otherwise, to any intellectual property rights is granted by this document or by any conduct of Vishay. Product names and markings noted herein may be trademarks of their respective owners.

Looking for pricing, stock, or lifecycle information?

Click below to explore more details on WIN SOURCE:

 [View VOM160RT on WIN SOURCE](#)

 [Vishay Information](#)

Optimize Your Supply Chain with WIN SOURCE Solutions

-  Global Sourcing Solution
-  Obsolete Management
-  Cost Control Management
-  Shortage Management
-  Alternative Solution
-  Excess Inventory Management