

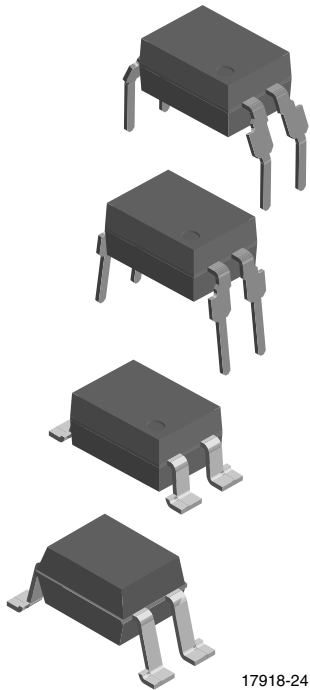

**THE DATASHEET OF
VO617A-7X017T**



Optocoupler, Phototransistor Output, High Reliability, 5300 V_{RMS}



17918-24

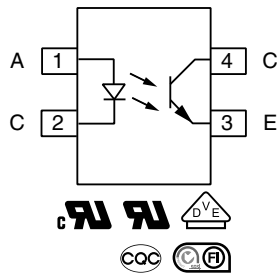

FEATURES

- Operating temperature from -55 °C to +110 °C
- Good CTR linearity depending on forward current
- Isolation voltage, 5300 V_{RMS}
- High collector emitter voltage, V_{CEO} = 80 V
- Low saturation voltage
- Fast switching times
- Low CTR degradation
- Low coupling capacitance
- End stackable, 0.100" (2.54 mm) spacing
- High common mode interference immunity
- Material categorization: for definitions of compliance please see www.vishay.com/doc?99912



DESCRIPTION

The 110 °C rated VO617A feature a high current transfer ratio, low coupling capacitance and high isolation voltage. These couplers have a GaAs infrared emitting diode, which is optically coupled to a silicon planar phototransistor detector, and is incorporated in a plastic DIP-4 package.

The coupling devices are designed for signal transmission between two electrically separated circuits.

The couplers are end-stackable with 2.54 mm spacing.

Creepage and clearance distances of > 8.0 mm are achieved with option 6 and option 8. This version complies with IEC 60950 (DIN VDE 0805) for reinforced insulation up to an operation voltage of 400 V_{RMS} or DC. Specifications subject to change.

APPLICATIONS

- AC adapters
- SMPS
- PLC
- Factory automation

AGENCY APPROVALS

Safety application model number covering all products in this data sheet is VO617A. This model number should be used when consulting safety agency documents.

- [UL / cUL 1577](#)
- [DIN EN 60747-5-5 \(VDE 0884-5\)](#), available with option 1
- [BSI](#)
- [CQC GB4943.1-2011](#)
- [CQC GB8898-2011](#)
- [FIMKO](#)

LINKS TO ADDITIONAL RESOURCES

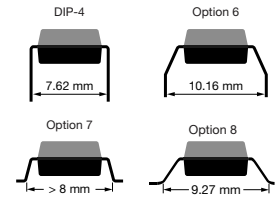
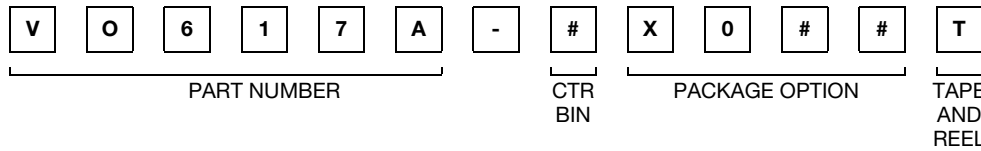

**ORDERING INFORMATION**

| AGENCY CERTIFIED / PACKAGE | CTR (%) | | | | | | | |
|----------------------------|--------------|---------------|---------------|---------------|---------------|---------------|---------------|---------------|
| | 5 mA | | | | | | | |
| UL, cUL, BSI, FIMKO | 50 to 600 | 40 to 80 | 63 to 125 | 100 to 200 | 160 to 320 | 80 to 160 | 130 to 260 | 200 to 400 |
| DIP-4 | VO617A | VO617A-1 | VO617A-2 | VO617A-3 | VO617A-4 | VO617A-7 | VO617A-8 | VO617A-9 |
| DIP-4, 400 mil, option 6 | - | - | - | VO617A-3X006 | VO617A-4X006 | - | - | - |
| SMD-4, option 7 | - | - | VO617A-2X007T | VO617A-3X007T | VO617A-4X007T | - | - | - |
| VDE, UL, cUL, BSI, FIMKO | 50 to 600 | 40 to 80 | 63 to 125 | 100 to 200 | 160 to 320 | 80 to 160 | 130 to 260 | 200 to 400 |
| DIP-4, 400 mil, option 6 | - | - | - | VO617A-3X016 | VO617A-4X016 | VO617A-7X016 | VO617A-8X016 | VO617A-9X016 |
| SMD-4, option 7 | - | VO617A-1X017T | VO617A-2X017T | VO617A-3X017T | VO617A-4X017T | VO617A-7X017T | VO617A-8X017T | VO617A-9X017T |
| SMD-4, 400 mil, option 8 | VO617A-X018T | - | - | VO617A-3X018T | VO617A-4X018T | - | - | - |

Note

- Additional options may be possible, please contact sales office

ABSOLUTE MAXIMUM RATINGS ($T_{amb} = 25\text{ }^{\circ}\text{C}$, unless otherwise specified)

| PARAMETER | CONDITIONS | SYMBOL | VALUE | UNIT |
|---------------------------|--------------------------------------|------------|-------------|--------------------|
| INPUT | | | | |
| Reverse voltage | | V_R | 6 | V |
| Forward current | | I_F | 60 | mA |
| Forward surge current | $t_p \leq 10\text{ }\mu\text{s}$ | I_{FSM} | 1.5 | A |
| LED power dissipation | | P_{diss} | 70 | mW |
| OUTPUT | | | | |
| Collector emitter voltage | | V_{CEO} | 80 | V |
| Emitter collector voltage | | V_{ECO} | 7 | V |
| Collector current | | I_C | 50 | mA |
| Collector peak current | $t_p/T = 0.5, t_p \leq 10\text{ ms}$ | I_{CM} | 100 | mA |
| Output power dissipation | | P_{diss} | 150 | mW |
| COUPLER | | | | |
| Total power dissipation | | P_{tot} | 200 | mW |
| Operation temperature | | T_{amb} | -55 to +110 | $^{\circ}\text{C}$ |
| Storage temperature range | | T_{stg} | -55 to +150 | $^{\circ}\text{C}$ |
| Soldering temperature | 2 mm from case, $\leq 10\text{ s}$ | T_{sld} | 260 | $^{\circ}\text{C}$ |

Notes

- Stresses in excess of the absolute maximum ratings can cause permanent damage to the device. Functional operation of the device is not implied at these or any other conditions in excess of those given in the operational sections of this document. Exposure to absolute maximum ratings for extended periods of the time can adversely affect reliability

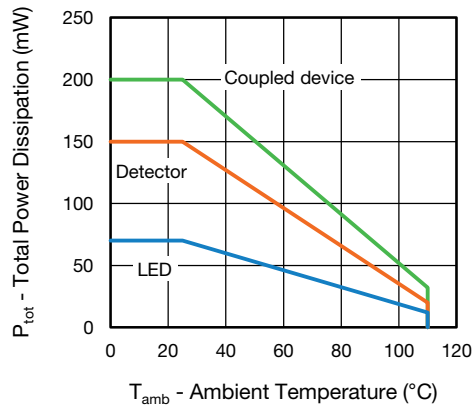

Fig. 1 - Total Power Dissipation vs. Ambient Temperature

| ELECTRICAL CHARACTERISTICS (T _{amb} = 25 °C, unless otherwise specified) | | | | | | | |
|---|--|----------|--------------------|------|------|------|------|
| PARAMETER | TEST CONDITION | PART | SYMBOL | MIN. | TYP. | MAX. | UNIT |
| INPUT | | | | | | | |
| Forward voltage | I _F = 60 mA | - | V _F | 1 | 1.35 | 1.65 | V |
| Reverse current | V _R = 6 V | - | I _R | - | 0.01 | 10 | μA |
| Junction capacitance | V _R = 0 V, f = 1 MHz | - | C _j | - | 13 | - | pF |
| OUTPUT | | | | | | | |
| Collector emitter leakage current | V _{CE} = 10 V | VO617A-1 | I _{CEO} | - | 2 | 50 | nA |
| | | VO617A-2 | | - | 2 | 50 | |
| | | VO617A-3 | | - | 5 | 100 | |
| | | VO617A-4 | | - | 5 | 100 | |
| | | VO617A-7 | | - | 5 | 100 | |
| | | VO617A-8 | | - | 5 | 100 | |
| | | VO617A-9 | | - | 5 | 100 | |
| Collector emitter capacitance | V _{CE} = 5 V, f = 1 MHz | - | C _{CE} | - | 5.2 | - | pF |
| Collector emitter breakdown voltage | I _C = 1 mA | - | BV _{CEO} | 80 | - | - | V |
| Emitter collector breakdown voltage | I _E = 100 μA | - | BV _{ECO} | 7 | - | - | V |
| COUPLER | | | | | | | |
| Collector emitter saturation voltage | I _F = 5 mA, I _C = 1.0 mA | - | V _{CEsat} | - | 0.25 | 0.4 | V |
| Coupling capacitance | f = 1 MHz | - | C _C | - | 0.4 | - | pF |

Note

- Minimum and maximum values are testing requirements. Typical values are characteristics of the device and are the result of engineering evaluation. Typical values are for information only and are not part of the testing requirements

| CURRENT TRANSFER RATIO ($T_{amb} = 25\text{ }^{\circ}\text{C}$, unless otherwise specified) | | | | | | | |
|---|---|----------|--------|------|------|------|------|
| PARAMETER | TEST CONDITION | PART | SYMBOL | MIN. | TYP. | MAX. | UNIT |
| I_C/I_F | $I_F = 5\text{ mA}$, $V_{CE} = 5\text{ V}$ | VO617A | CTR | 50 | - | 600 | % |
| | | VO617A-1 | CTR | 40 | - | 80 | % |
| | | VO617A-2 | CTR | 63 | - | 125 | % |
| | | VO617A-3 | CTR | 100 | - | 200 | % |
| | | VO617A-4 | CTR | 160 | - | 320 | % |
| | | VO617A-7 | CTR | 80 | - | 160 | % |
| | | VO617A-8 | CTR | 130 | - | 260 | % |
| VO617A-9 | CTR | 200 | - | 400 | % | | |

| SWITCHING CHARACTERISTICS ($T_{amb} = 25\text{ }^{\circ}\text{C}$, unless otherwise specified) | | | | | | | |
|--|--|---------|---------------|------|------|------|---------------|
| PARAMETER | TEST CONDITION | CTR BIN | SYMBOL | MIN. | TYP. | MAX. | UNIT |
| NON-SATURATED | | | | | | | |
| Rise and fall time | $I_F = 5\text{ mA}$, $V_{CC} = 5\text{ V}$, $R_L = 75\text{ }\Omega$ | - | t_r , t_f | - | 2 | - | μs |
| Turn-on time | $I_F = 5\text{ mA}$, $V_{CC} = 5\text{ V}$, $R_L = 75\text{ }\Omega$ | - | t_{on} | - | 3 | - | μs |
| Turn-off time | | - | t_{off} | - | 2.3 | - | μs |
| Cut-off frequency | $I_F = 5\text{ mA}$, $V_{CC} = 5\text{ V}$, $R_L = 75\text{ }\Omega$ | - | f_{ctr} | - | 190 | - | kHz |
| SATURATED | | | | | | | |
| Turn-on time | $I_F = 5\text{ mA}$ | - | t_{on} | - | 6 | - | μs |
| Turn-off time | $I_F = 5\text{ mA}$ | - | t_{off} | - | 25 | - | μs |
| Rise time | $I_F = 5\text{ mA}$ | - | t_r | - | 4.6 | - | μs |
| Fall time | $I_F = 5\text{ mA}$ | - | t_f | - | 15 | - | μs |

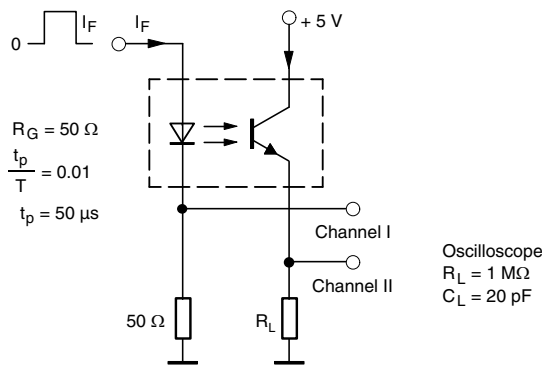

95 10804-3

Fig. 2 - Test Circuit, Non-Saturated Operation

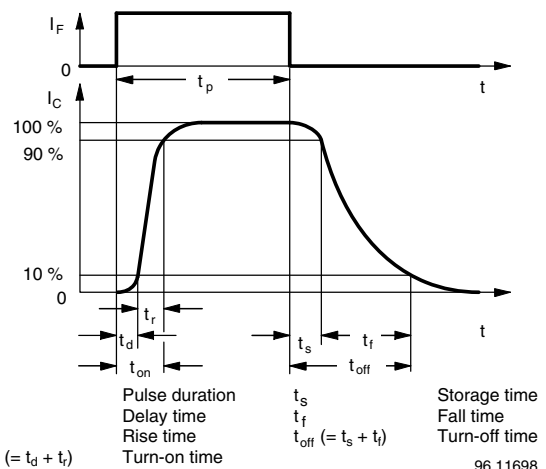
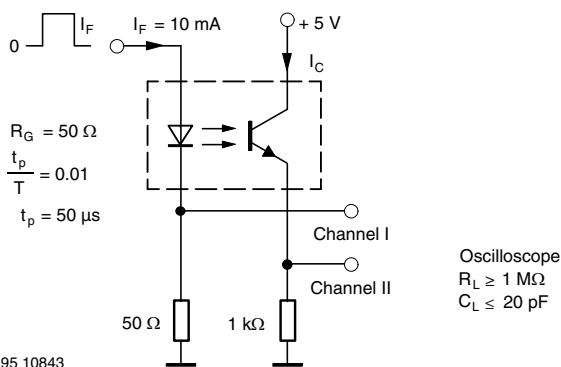

Fig. 4 - Switching Times



95 10843

Fig. 3 - Test Circuit, Saturated Operation



| SAFETY AND INSULATION RATINGS | | | | |
|--|--|-------------------|--------------------|-------------------|
| PARAMETER | CONDITION | SYMBOL | VALUE | UNIT |
| Climatic classification | According to IEC 68 part 1 | | 55 / 115 / 21 | |
| Pollution degree | According to DIN VDE 0109 | | 2 | |
| Comparative tracking index | Insulation group IIIa | CTI | 175 | |
| Maximum rated withstanding isolation voltage | According to UL1577, t = 1 min | V _{ISO} | 5300 | V _{RMS} |
| Maximum transient isolation voltage | According to DIN EN 60747-5-5 | V _{IOTM} | 8000 | V _{peak} |
| Maximum repetitive peak isolation voltage | According to DIN EN 60747-5-5 | V _{IORM} | 890 | V _{peak} |
| Isolation resistance | T _{amb} = 115 °C, V _{IO} = 500 V | R _{IO} | ≥ 10 ¹¹ | Ω |
| | T _{amb} = 175 °C, V _{IO} = 500 V | R _{IO} | ≥ 10 ⁹ | Ω |
| Output safety power | | P _{SO} | 700 | mW |
| Input safety current | | I _{SI} | 400 | mA |
| Input safety temperature | | T _S | 175 | °C |
| Creepage distance | DIP-4 | | ≥ 7 | mm |
| Clearance distance | DIP-4 | | ≥ 7 | mm |
| Creepage distance | DIP-4, 400 mil, option 6 | | ≥ 8 | mm |
| Clearance distance | DIP-4, 400 mil, option 6 | | ≥ 8 | mm |
| Creepage distance | SMD-4, option 7 | | ≥ 7 | mm |
| Clearance distance | SMD-4, option 7 | | ≥ 7 | mm |
| Creepage distance | SMD-4, 400 mil, option 8 | | ≥ 8 | mm |
| Clearance distance | SMD-4, 400 mil, option 8 | | ≥ 8 | mm |
| Insulation thickness | | DTI | ≥ 0.4 | mm |

Note

- As per DIN EN 60747-5-5, § 7.4.3.8.2, this optocoupler is suitable for “safe electrical insulation” only within the safety ratings. Compliance with the safety ratings shall be ensured by means of protective circuits

TYPICAL CHARACTERISTICS ($T_{amb} = 25\text{ }^{\circ}\text{C}$, unless otherwise specified)

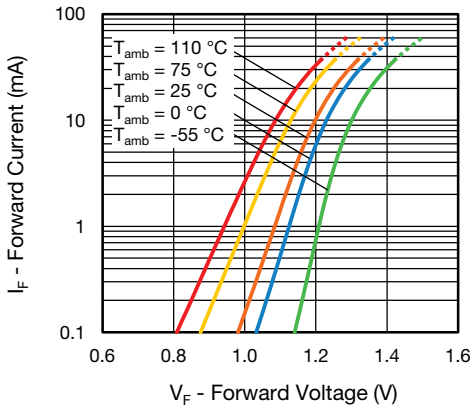

Fig. 5 - Forward Voltage vs. Forward Current

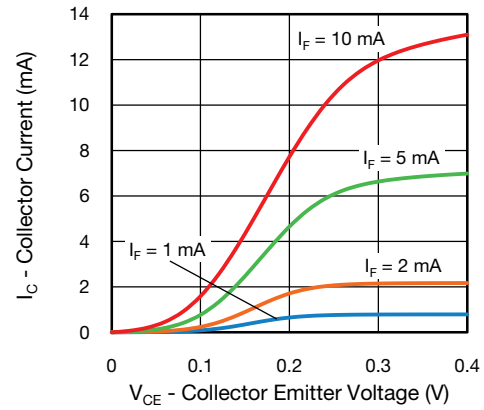

Fig. 8 - Collector Current vs. Collector Emitter Voltage

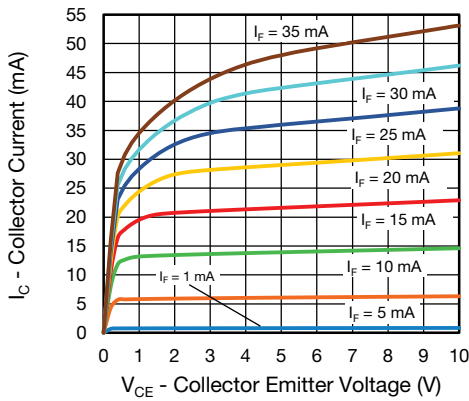

Fig. 6 - Collector Current vs. Collector Emitter Voltage

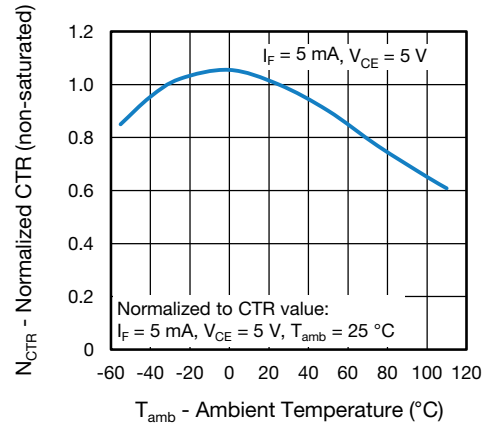

Fig. 9 - Normalized Current Transfer Ratio (non-sat.) vs. Ambient Temperature

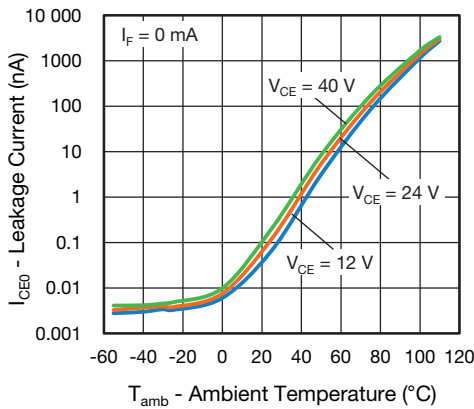

Fig. 7 - Leakage Current vs. Ambient Temperature

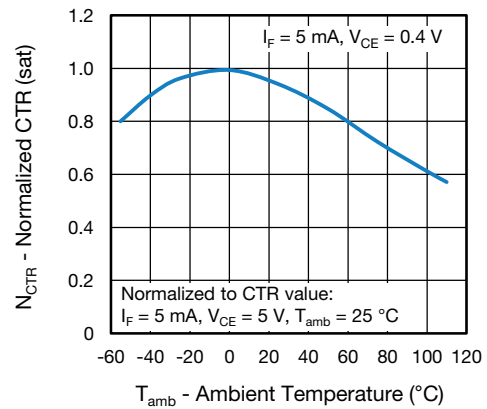

Fig. 10 - Normalized Current Transfer Ratio (sat.) vs. Ambient Temperature

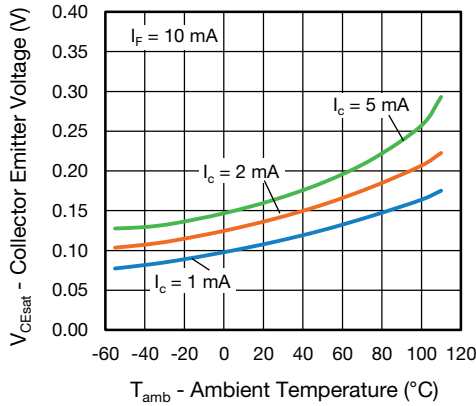

Fig. 11 - Collector Emitter Voltage vs. Ambient Temperature

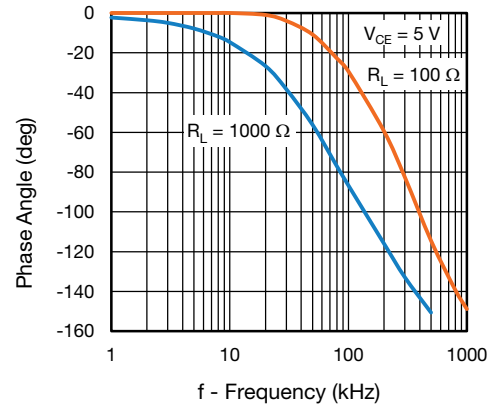

Fig. 14 - Phase Angle vs. Frequency

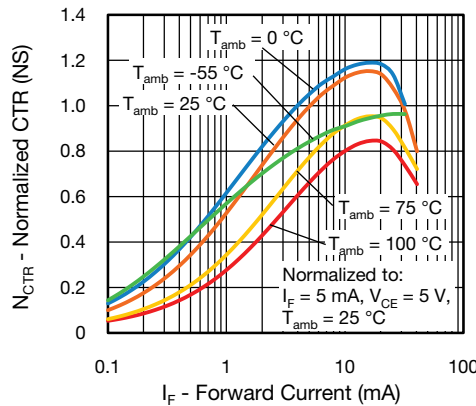

Fig. 12 - Normalized CTR (non-sat.) vs. Forward Current

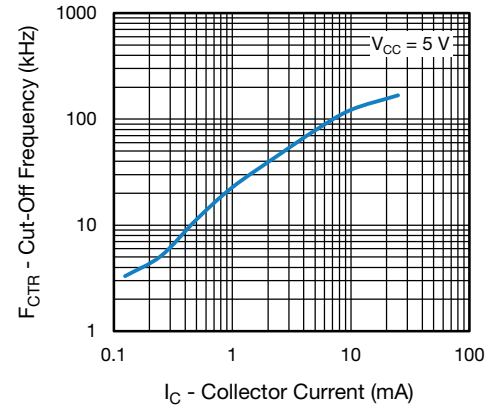

Fig. 15 - Cut-Off Frequency vs. Collector Current

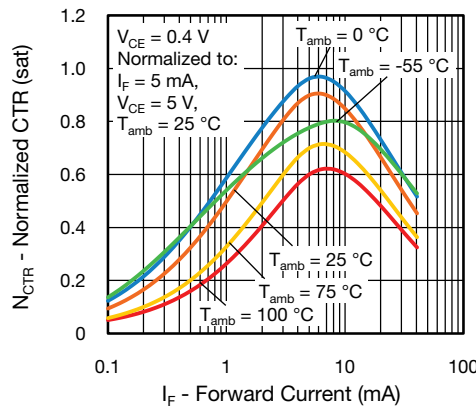

Fig. 13 - Normalized CTR (sat.) vs. Forward Current

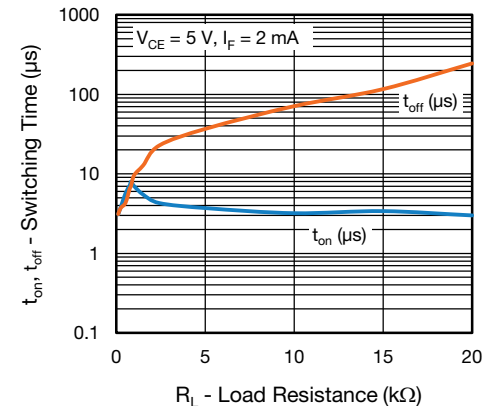

Fig. 16 - Switching Time vs. Load Resistance

PACKAGE DIMENSIONS (in millimeters)

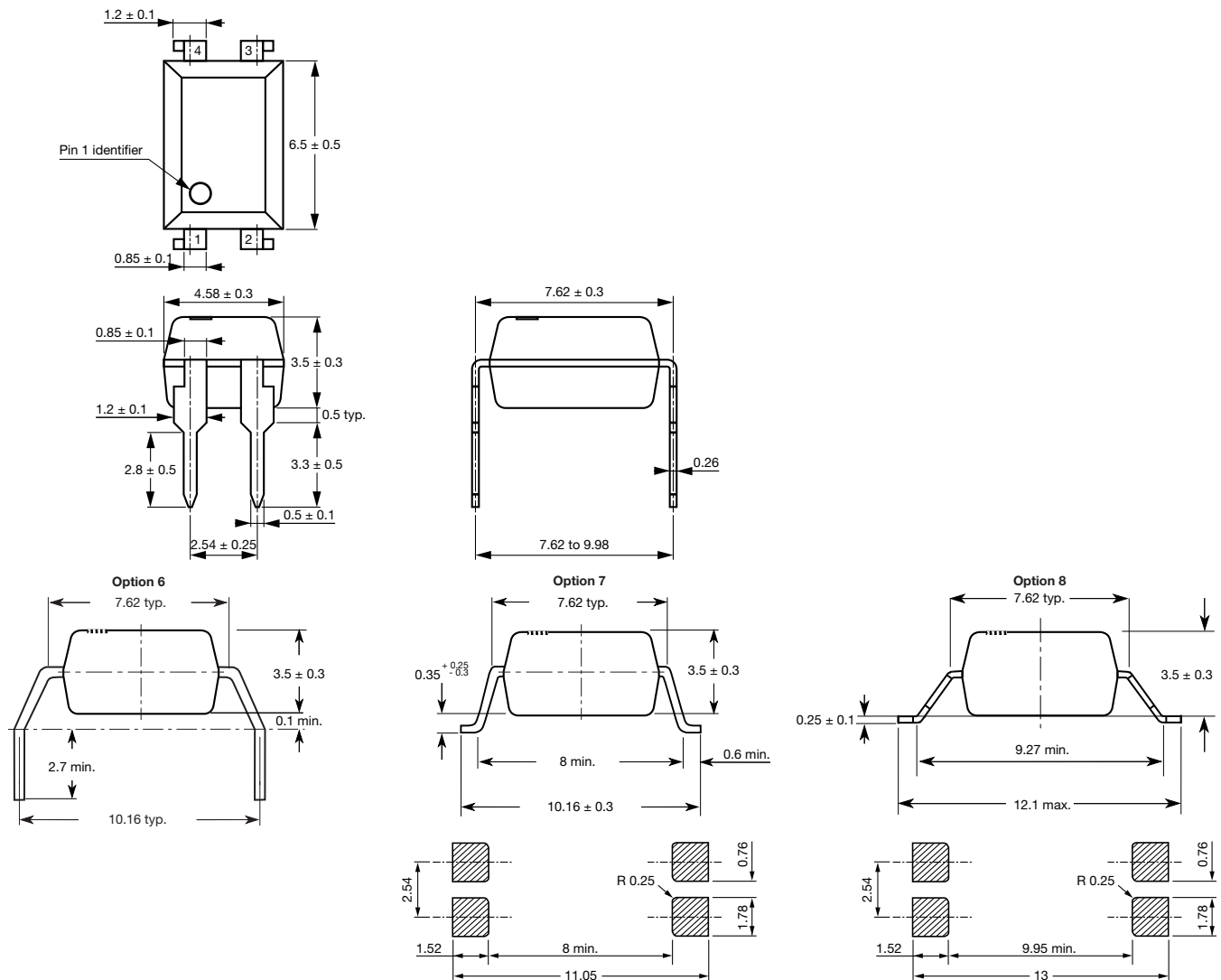

Fig. 17 - Package Drawings

PACKAGE MARKING

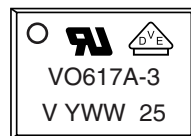

Fig. 18 - Example of VO617A-3X017T

Notes

- The VDE logo is only marked on option 1 parts. Option information is not marked on the part
- Tape and reel suffix (T) is not part of the package marking

PACKING INFORMATION

| DEVICE PER TUBE | | | |
|-----------------|------------|-----------|-----------|
| TYPE | UNITS/TUBE | TUBES/BOX | UNITS/BOX |
| DIP-4 | 100 | 40 | 4000 |

| DEVICE PER TAPE AND REEL | |
|--------------------------|------------|
| TYPE | UNITS/REEL |
| SMD-4, option 7 | 1000 |
| SMD-4, 400 mil, option 8 | 2000 |

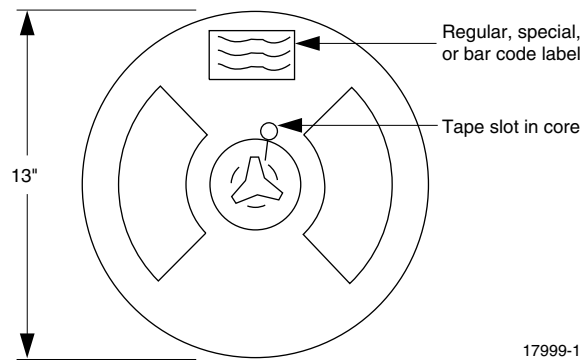

Fig. 19 - Tape and Reel Shipping Medium

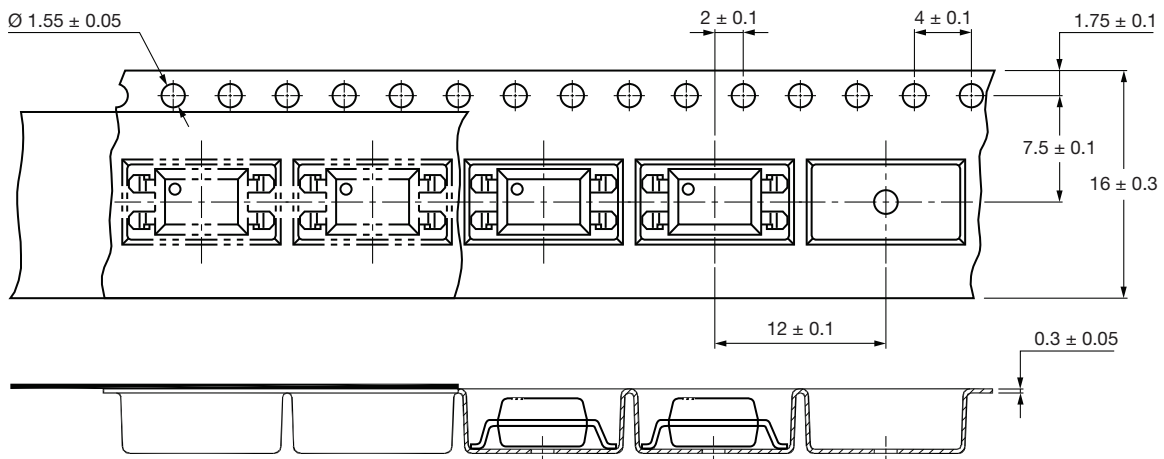

Fig. 20 - Tape and Packing for Option 7 (1000 units per reel)

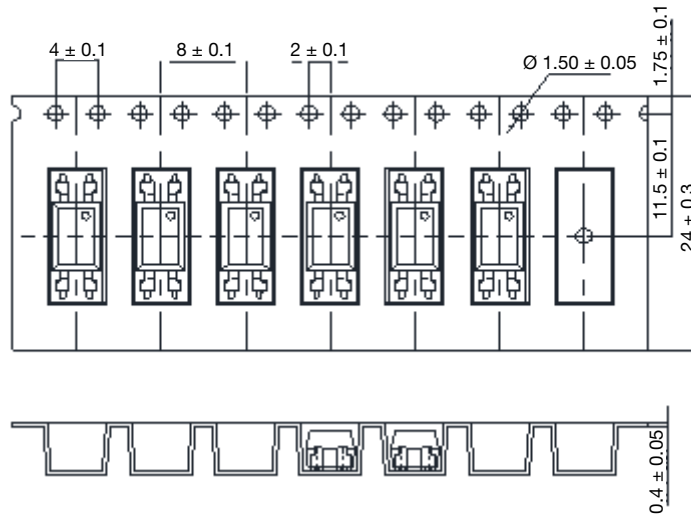
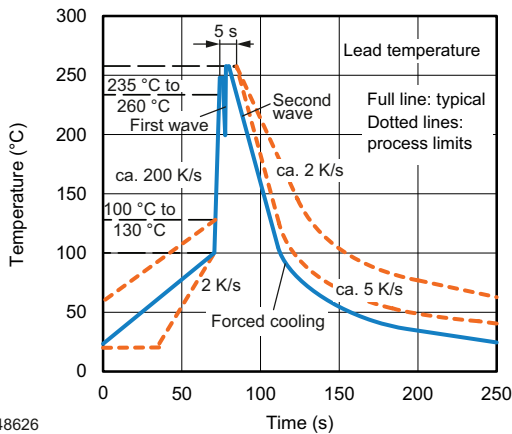

Fig. 21 - Tape and Reel Packaging for Option 8 (2000 units per reel)

SOLDER PROFILES



948626

Fig. 22 - Wave Soldering Double Wave Profile According to J-STD-020 for DIP Devices

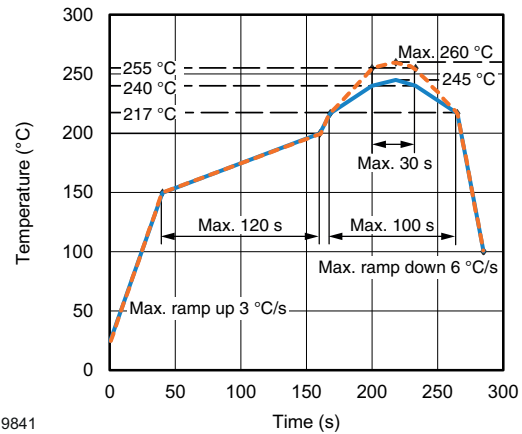

19841

Fig. 23 - Lead (Pb)-free Reflow Solder Profile According to J-STD-020 for SMD Devices

HANDLING AND STORAGE CONDITIONS

ESD level: HBM class 2

Floor life: unlimited

Conditions: $T_{amb} < 30\text{ }^{\circ}\text{C}$, RH < 85 %

Moisture sensitivity level 1, according to J-STD-020



Disclaimer

ALL PRODUCT, PRODUCT SPECIFICATIONS AND DATA ARE SUBJECT TO CHANGE WITHOUT NOTICE TO IMPROVE RELIABILITY, FUNCTION OR DESIGN OR OTHERWISE.

Vishay Intertechnology, Inc., its affiliates, agents, and employees, and all persons acting on its or their behalf (collectively, "Vishay"), disclaim any and all liability for any errors, inaccuracies or incompleteness contained in any datasheet or in any other disclosure relating to any product.

Vishay makes no warranty, representation or guarantee regarding the suitability of the products for any particular purpose or the continuing production of any product. To the maximum extent permitted by applicable law, Vishay disclaims (i) any and all liability arising out of the application or use of any product, (ii) any and all liability, including without limitation special, consequential or incidental damages, and (iii) any and all implied warranties, including warranties of fitness for particular purpose, non-infringement and merchantability.

Statements regarding the suitability of products for certain types of applications are based on Vishay's knowledge of typical requirements that are often placed on Vishay products in generic applications. Such statements are not binding statements about the suitability of products for a particular application. It is the customer's responsibility to validate that a particular product with the properties described in the product specification is suitable for use in a particular application. Parameters provided in datasheets and / or specifications may vary in different applications and performance may vary over time. All operating parameters, including typical parameters, must be validated for each customer application by the customer's technical experts. Product specifications do not expand or otherwise modify Vishay's terms and conditions of purchase, including but not limited to the warranty expressed therein.

Hyperlinks included in this datasheet may direct users to third-party websites. These links are provided as a convenience and for informational purposes only. Inclusion of these hyperlinks does not constitute an endorsement or an approval by Vishay of any of the products, services or opinions of the corporation, organization or individual associated with the third-party website. Vishay disclaims any and all liability and bears no responsibility for the accuracy, legality or content of the third-party website or for that of subsequent links.

Except as expressly indicated in writing, Vishay products are not designed for use in medical, life-saving, or life-sustaining applications or for any other application in which the failure of the Vishay product could result in personal injury or death. Customers using or selling Vishay products not expressly indicated for use in such applications do so at their own risk. Please contact authorized Vishay personnel to obtain written terms and conditions regarding products designed for such applications.

No license, express or implied, by estoppel or otherwise, to any intellectual property rights is granted by this document or by any conduct of Vishay. Product names and markings noted herein may be trademarks of their respective owners.

Looking for pricing, stock, or lifecycle information?

Click below to explore more details on WIN SOURCE:

 [View VO617A-7X017T on WIN SOURCE](#)

 [Vishay Information](#)

Optimize Your Supply Chain with WIN SOURCE Solutions

-  Global Sourcing Solution
-  Obsolete Management
-  Cost Control Management
-  Shortage Management
-  Alternative Solution
-  Excess Inventory Management