



# THE DATASHEET OF UDD32C24L01



# DATA SHEET

**ELECTROSTATIC DISCHARGE  
PROTECTION DEVICES**

**INDUSTRIAL / CONSUMER**

UDD32CXXL01 series

RoHS compliant & Halogen free



Product specification—July 04, 2023 V.2



## Electrostatic Discharged Protection Devices (ESD) Data Sheet

### Description

The series are an ultra low capacitance TVS array designed to protect high speed data interfaces. This series has been specifically designed to protect sensitive components which are connected to data and transmission lines from overvoltage caused by electrostatic discharge (ESD), cable discharge events (CDE) and lightning.

The unique design incorporates surge rated, low capacitance steering diodes and a TVS diode in a single package. During transient conditions, the steering diodes direct the transient current to ground. The internal TVS diode clamps the transient voltage to a safe level. The ultra low capacitance array configuration allows the user to protect up to the high speed data lines. These devices are in a signal package, RoHS/WEEE compliant, SOD-323 package. It measures 2.5×1.25×1.0mm.

The series devices may be used to meet the immunity requirements of IEC61000-4-2 (ESD), IEC61000-4-4 (EFT) and IEC61000-4-5 (Surge).



Contact : ±30kV  
Air : ±30kV



### Features

- IEC61000-4-2 ESD 30KV Air, 30KV contact compliance  
ESD 15KV Air, 8KV contact compliance for UDD32C36L01
- SOD-323 surface mount package
- Protects one I/O line
- Working voltage: 3V, 5V, 8V, 12V, 15V, 24V, 36V
- Low leakage current
- Low operating and clamping voltages
- Solid-state silicon avalanche technology
- Lead Free/RoHS compliant
- Solder reflow temperature: Pure Tin-Sn, 260~270°C
- Flammability rating UL 94V-0
- Meets MSL level 1, per J-STD-020

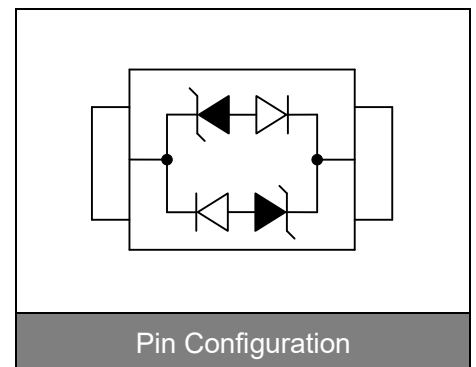

### Applications

- USB 2.0 and USB 3.0 interface
- 10/100/1000 Ethernet
- Personal digital assistants (PDA)
- Serial ATA protection
- Digital visual interface (DVI)
- Wireless system devices
- Handhelds and notebooks
- Digital cameras
- RF interface

## Maximum Ratings

Rating	Symbol	Value	Unit
Peak pulse power (tp=8/20μs waveform)	P <sub>PP</sub>	350	W
ESD voltage (Contact discharge)	V <sub>ESD</sub>	±30	kV
ESD voltage (Air discharge)		±30	
Storage & operating temperature range	T <sub>STG</sub> , T <sub>J</sub>	-55~+150	°C

## Electrical Characteristics (T<sub>J</sub>=25°C)

### UDD32C03L01 (Marking: AC)

Parameter	Symbol	Condition	Min.	Typ.	Max.	Unit
Reverse stand-off voltage	V <sub>RWM</sub>				3.3	V
Reverse breakdown voltage	V <sub>BR</sub>	I <sub>BR</sub> =1mA	4			V
Reverse leakage current	I <sub>R</sub>	V <sub>R</sub> =3.3V			5	μA
Clamping voltage (tp=8/20μs)	V <sub>C</sub>	I <sub>PP</sub> =1A			7	V
Clamping voltage (tp=8/20μs)	V <sub>C</sub>	I <sub>PP</sub> =5A			15	V
Peak Pulse Current (tp=8/20μs)	I <sub>PP</sub>				19	A
Off state junction capacitance	C <sub>J</sub>	0Vdc, f=1MHz		0.8		pF

### UDD32C05L01 (Marking: BC)

Parameter	Symbol	Condition	Min.	Typ.	Max.	Unit
Reverse stand-off voltage	V <sub>RWM</sub>				5	V
Reverse breakdown voltage	V <sub>BR</sub>	I <sub>BR</sub> =1mA	6			V
Reverse leakage current	I <sub>R</sub>	V <sub>R</sub> =5V			5	μA
Clamping voltage (tp=8/20μs)	V <sub>C</sub>	I <sub>PP</sub> =1A			9.8	V
Clamping voltage (tp=8/20μs)	V <sub>C</sub>	I <sub>PP</sub> =5A			18.3	V
Peak Pulse Current (tp=8/20μs)	I <sub>PP</sub>				17	A
Off state junction capacitance	C <sub>J</sub>	0Vdc, f=1MHz		0.8		pF

### UDD32C08L01 (Marking: BC.)

Parameter	Symbol	Condition	Min.	Typ.	Max.	Unit
Reverse stand-off voltage	V <sub>RWM</sub>				8	V
Reverse breakdown voltage	V <sub>BR</sub>	I <sub>BR</sub> =1mA	8.5			V
Reverse leakage current	I <sub>R</sub>	V <sub>R</sub> =8V			1	μA
Clamping voltage (tp=8/20μs)	V <sub>C</sub>	I <sub>PP</sub> =1A			13	V
Clamping voltage (tp=8/20μs)	V <sub>C</sub>	I <sub>PP</sub> =10A			24	V
Peak Pulse Current (tp=8/20μs)	I <sub>PP</sub>				17	A
Off state junction capacitance	C <sub>J</sub>	0Vdc, f=1MHz		1		pF

## UDD32C12L01 (Marking: DC)

Parameter	Symbol	Condition	Min.	Typ.	Max.	Unit
Reverse stand-off voltage	$V_{RWM}$				12	V
Reverse breakdown voltage	$V_{BR}$	$I_{BR}=1mA$	13.3			V
Reverse leakage current	$I_R$	$V_R=12V$			1	$\mu A$
Clamping voltage (tp=8/20 $\mu s$ )	$V_C$	$I_{PP}=1A$			19	V
Clamping voltage (tp=8/20 $\mu s$ )	$V_C$	$I_{PP}=5A$			28.6	V
Peak Pulse Current (tp=8/20 $\mu s$ )	$I_{PP}$				7	A
Off state junction capacitance	$C_J$	0Vdc,f=1MHz		0.8		pF

## UDD32C15L01 (Marking: EC)

Parameter	Symbol	Condition	Min.	Typ.	Max.	Unit
Reverse stand-off voltage	$V_{RWM}$				15	V
Reverse breakdown voltage	$V_{BR}$	$I_{BR}=1mA$	16.7			V
Reverse leakage current	$I_R$	$V_R=15V$			1	$\mu A$
Clamping voltage (tp=8/20 $\mu s$ )	$V_C$	$I_{PP}=1A$			24	V
Clamping voltage (tp=8/20 $\mu s$ )	$V_C$	$I_{PP}=5A$			35	V
Peak Pulse Current (tp=8/20 $\mu s$ )	$I_{PP}$				6	A
Off state junction capacitance	$C_J$	0Vdc,f=1MHz		0.8		pF

## UDD32C24L01 (Marking: HC)

Parameter	Symbol	Condition	Min.	Typ.	Max.	Unit
Reverse stand-off voltage	$V_{RWM}$				24	V
Reverse breakdown voltage	$V_{BR}$	$I_{BR}=1mA$	26.7			V
Reverse leakage current	$I_R$	$V_R=24V$			1	$\mu A$
Clamping voltage (tp=8/20 $\mu s$ )	$V_C$	$I_{PP}=1A$			43	V
Clamping voltage (tp=8/20 $\mu s$ )	$V_C$	$I_{PP}=5A$			56	V
Peak Pulse Current (tp=8/20 $\mu s$ )	$I_{PP}$				6	A
Off state junction capacitance	$C_J$	0Vdc,f=1MHz		0.8		pF

UDD32C36L01 (Marking: KC)

Parameter	Symbol	Condition	Min.	Typ.	Max.	Unit
Reverse stand-off voltage	$V_{RWM}$				36	V
Reverse breakdown voltage	$V_{BR}$	$I_{BR}=1mA$	40			V
Reverse leakage current	$I_R$	$V_R=36V$			1	$\mu A$
Clamping voltage ( $t_p=8/20\mu s$ )	$V_C$	$I_{PP}=1A$			70	V
Clamping voltage ( $t_p=8/20\mu s$ )	$V_C$	$I_{PP}=2A$			75	V
Peak Pulse Current ( $t_p=8/20\mu s$ )	$I_{PP}$				3	A
Off state junction capacitance	$C_J$	0Vdc, f=1MHz		0.8		pF

**Typical Characteristics Curves**

Figure 1. Power Derating Curve

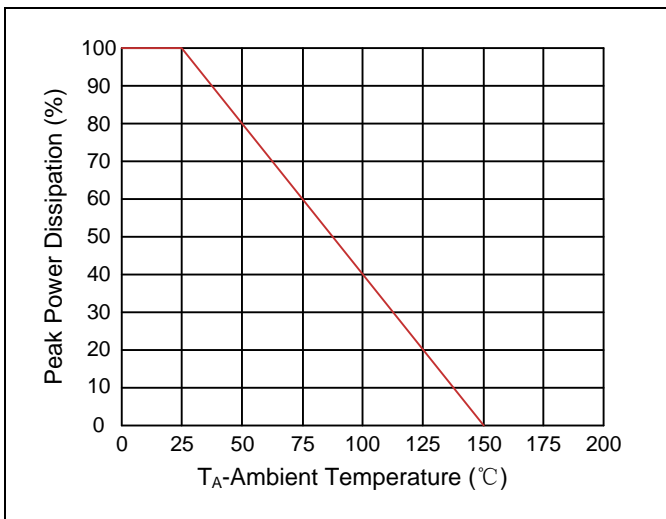

Figure 2. Pulse Waveform

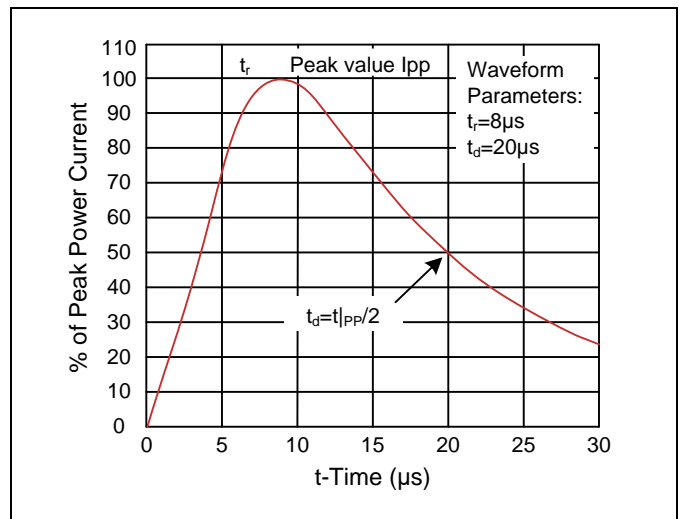

Figure 3. Non-Repetitive Peak Pulse vs Pulse Time

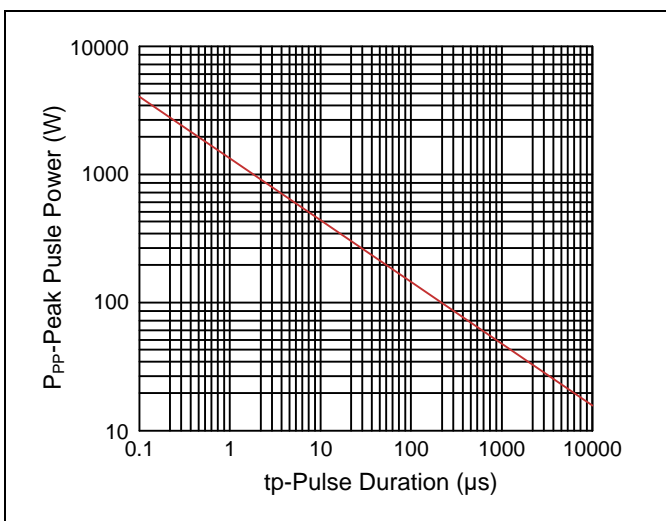
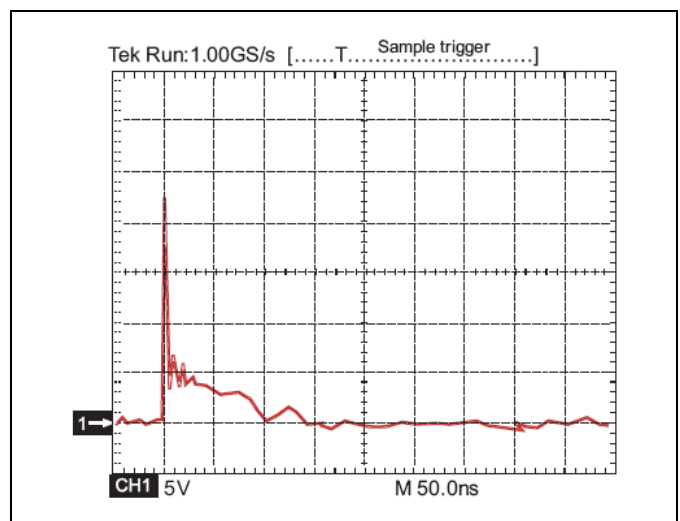
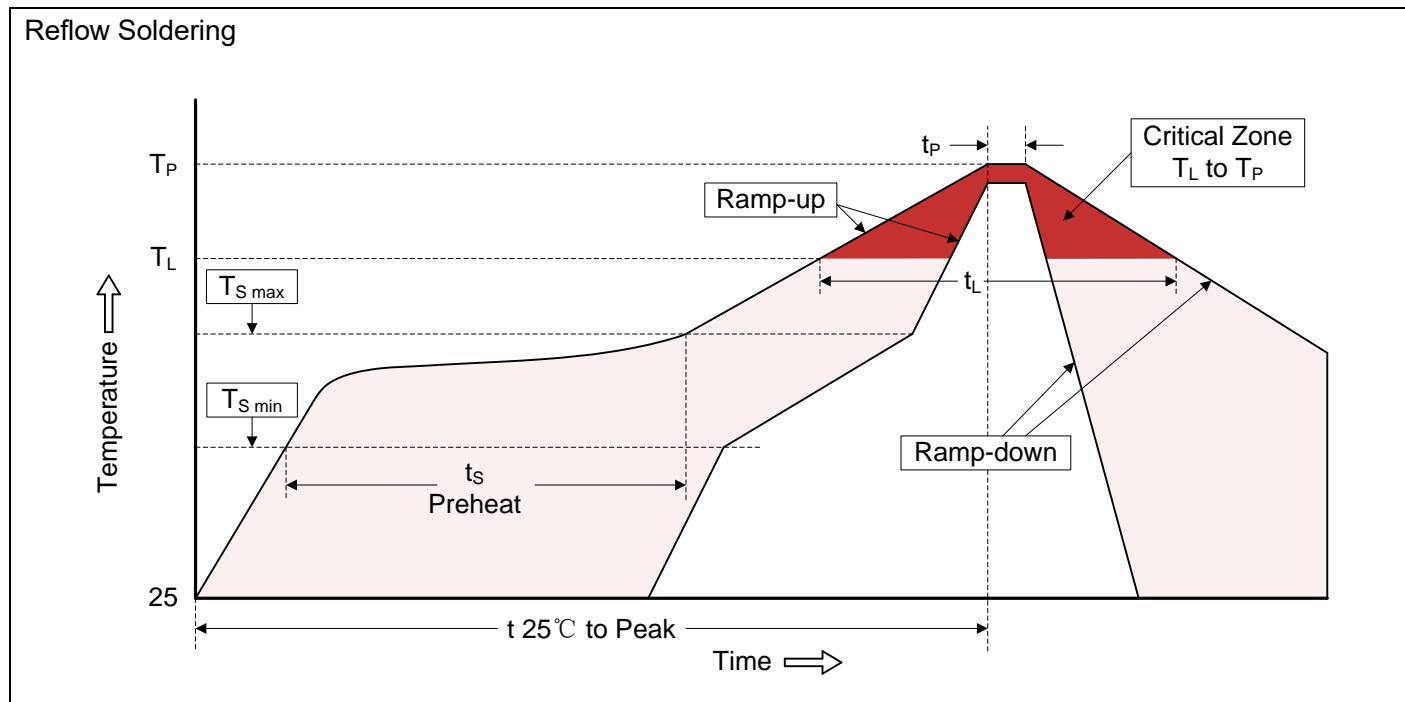

Figure 4. ESD Clamping (8kV Contact IEC61000-4-2)



**Recommended Soldering Conditions**



**Recommended Condition**

Profile Feature	Pb-Free Assembly
Average ramp-up rate ( $T_L$ to $T_P$ )	3°C/second max.
Preheat	
-Temperature Min ( $T_{S\ min}$ )	150°C
-Temperature Max ( $T_{S\ max}$ )	200°C
-Time (min to max) ( $t_s$ )	60-180 seconds
$T_{S\ max}$ to $T_L$	
-Ramp-up Rate	3°C/second max.
Time maintained above:	
-Temperature ( $T_L$ )	217°C
-Time ( $t_L$ )	60-150 seconds
Peak Temperature ( $T_P$ )	260°C
Time within 5°C of actual Peak Temperature ( $t_p$ )	20-40 seconds
Ramp-down Rate	6°C/second max.
Time 25°C to Peak Temperature	8 minutes max.

**Dimensions (SOD-323)**

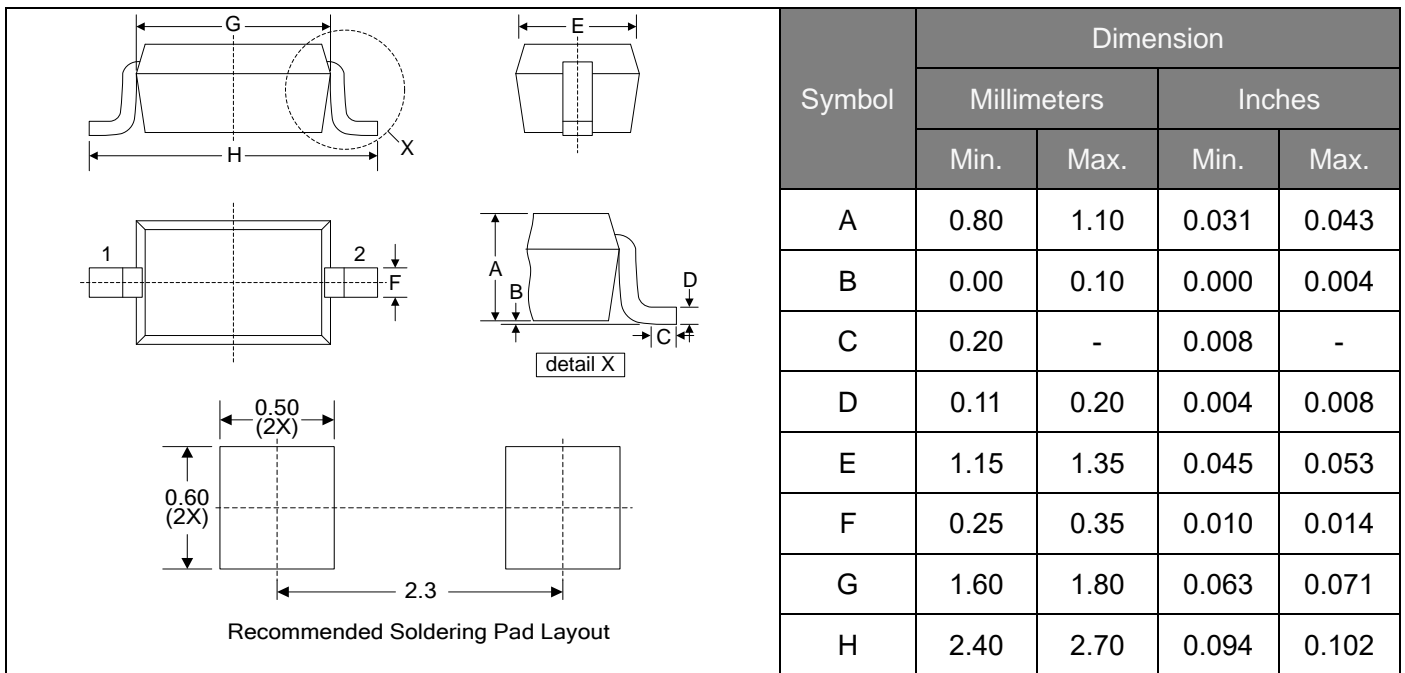

**Packaging**

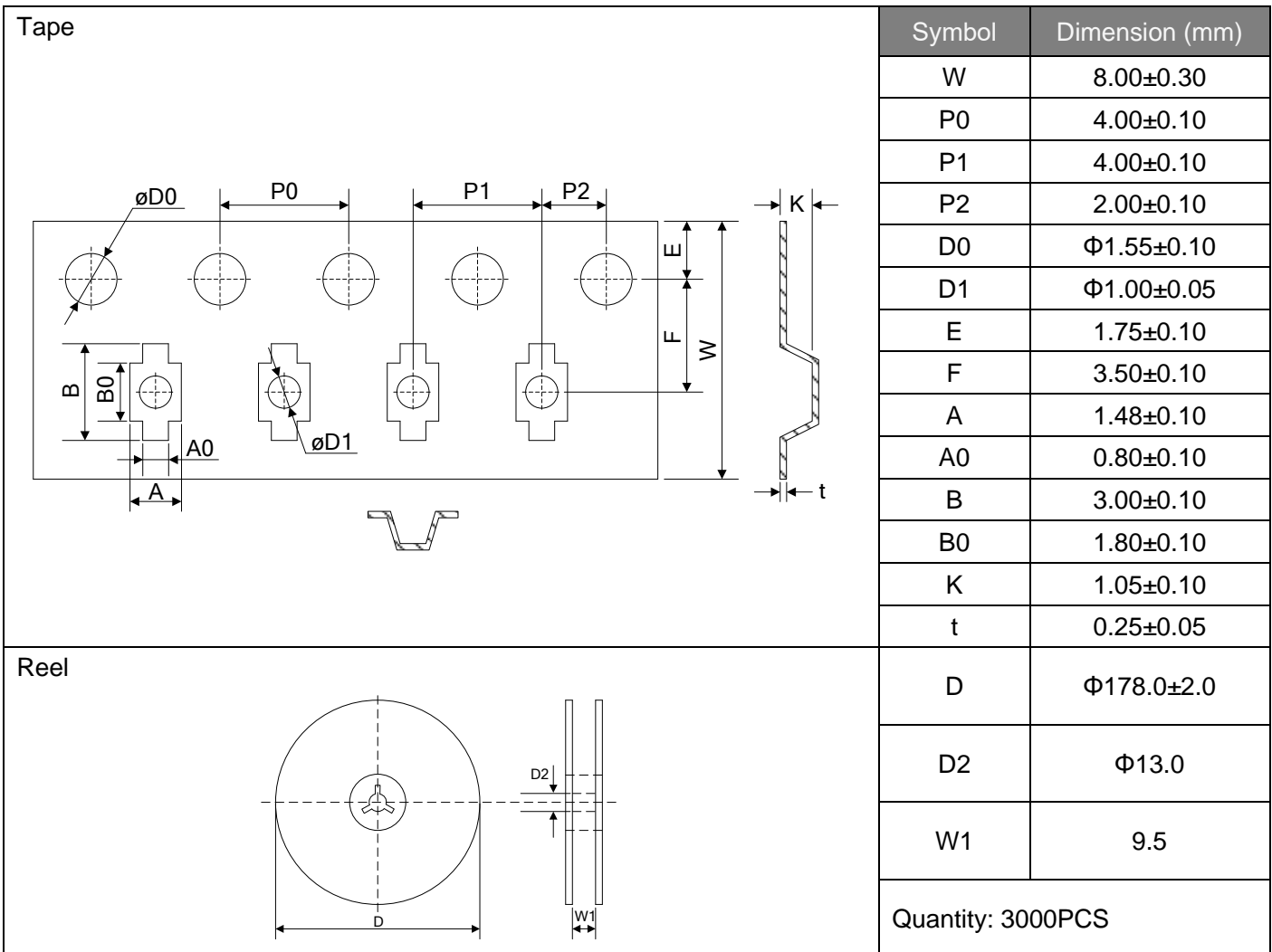

## LEGAL DISCLAIMER

YAGEO, its distributors and agents (collectively, "YAGEO"), hereby disclaims any and all liabilities for any errors, inaccuracies or incompleteness contained in any product related information, including but not limited to product specifications, datasheets, pictures and/or graphics. YAGEO may make changes, modifications and/or improvements to product related information at any time and without notice.



YAGEO makes no representation, warranty, and/or guarantee about the fitness of its products for any particular purpose or the continuing production of any of its products. To the maximum extent permitted by law, YAGEO disclaims (i) any and all liability arising out of the application or use of any YAGEO product, (ii) any and all liability, including without limitation special, consequential or incidental damages, and (iii) any and all implied warranties, including warranties of fitness for a particular purpose, non-infringement and merchantability.

YAGEO products are designed for general purpose applications under normal operation and usage conditions. Please contact YAGEO for the applications listed below which require especially high reliability for the prevention of defects which might directly cause damage to the third party's life, body or property: Aerospace equipment (artificial satellite, rocket, etc.), Atomic energy-related equipment, Aviation equipment, Disaster prevention equipment, crime prevention equipment, Electric heating apparatus, burning equipment, Highly public information network equipment, data-processing equipment, Medical devices, Military equipment, Power generation control equipment, Safety equipment, Traffic signal equipment, Transportation equipment and Undersea equipment, or for any other application or use in which the failure of YAGEO products could result in personal injury or death, or serious property damage. Particularly **YAGEO Corporation and its affiliates do not recommend the use of commercial or automotive grade products for high reliability applications or manned space flight.**

Information provided here is intended to indicate product specifications only. YAGEO reserves all the rights for revising this content without further notification, as long as products are unchanged. Any product change will be announced by PCN.

## Looking for pricing, stock, or lifecycle information?

Click below to explore more details on WIN SOURCE:

-  [View UDD32C24L01 on WIN SOURCE](#)
-  [Yageo Information](#)

## Optimize Your Supply Chain with WIN SOURCE Solutions

-  Global Sourcing Solution
-  Obsolete Management
-  Cost Control Management
-  Shortage Management
-  Alternative Solution
-  Excess Inventory Management