



**THE DATASHEET OF
TSS-44+**





WIDEBAND, MICROWAVE, SHUTDOWN

Monolithic Amplifier

TSS-44+

50Ω 22 to 43.5 GHz

THE BIG DEAL

- Super high frequency and wideband, 22 to 43.5 GHz
- Gain, 17.6 dB typ. & Flatness, ±0.9 dB to 40 GHz
- Excellent active directivity, 28 dB typ.
- Positive Supply Voltage, 4V, 22mA
- Integrated DC blocks, Bias-Tee & Microwave bypass capacitor
- Unconditionally Stable
- Aqueous washable; 3mm x 3mm SMT package
- Shutdown feature

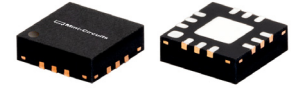

Generic photo used for illustration purposes only

CASE STYLE: DQ1225

+RoHS Compliant

The +Suffix identifies RoHS Compliance. See our web site for RoHS Compliance methodologies and qualifications

APPLICATIONS

- 5G
- Radio Navigation
- Mobile
- Fixed satellite
- Space research

PRODUCT OVERVIEW

The TSS-44+ is a surface mount, MMIC amplifier with shutdown feature fabricated using E-PHEMT technology and is a fully integrated 3-stage gain block up to 43.5 GHz with excellent active directivity. It is packaged in industry standard 3x3 mm MCLP package, which provides excellent RF and thermal performance. The TSS-44+ integrates the entire matching network with the majority of the bias circuit inside the package, reducing the need for complicated external circuits. This approach makes the TSS-44+ extremely flexible and enables simple, straightforward use.

KEY FEATURES

Feature	Advantages
Wideband, 22 to 43.5 GHz	The broad frequency range supports a wide array of requirements including telecommunications applications such as 5G and microwave radio backhaul, broadband commercial test and measurement systems, radar and commercial satellite applications
Excellent Gain Flatness	Typical ±0.9 dB gain flatness across the entire frequency range minimizes the need for external equalizer networks making it a great fit for instrumentation and other broadband applications
High Directivity	With active directivity of 28 dB, the TSS-44+ is an excellent choice for buffering broadband circuits. eliminating the need for an expensive isolator in most cases.
Shutdown feature	Allow users to turn on and off the amplifier with pulsed signals while keeping the power supply at constant voltage.
Small size	3x3 mm, 12-lead MCLP package
Integrated DC Blocks & Bias-Tee	Saves motherboard space and minimizes overall cost. Very user friendly.

REV. A
ECO-011809
TSS-44+
GY/RS/CP
220128





WIDEBAND, MICROWAVE, SHUTDOWN

Monolithic Amplifier

TSS-44+

Mini-Circuits

ELECTRICAL SPECIFICATIONS¹ AT 25°C, Z₀=50Ω, AND V_{DD}=4V, UNLESS OTHERWISE NOTED.

Parameter	Condition (GHz)	Amplifier-ON			Amplifier-OFF	Units
		Min.	Typ.	Max.	Typ.	
Frequency Range		22		43.5	22-43.5	GHz
Noise Figure	22		3.7		—	dB
	25		3.3		—	
	30		3.2		—	
	35		3.3		—	
	40		3.5		—	
	43.5		4.2		—	
Gain	22	13.5	15.8	18.6	-41	dB
	25	14.3	16.8	19.7	-33	
	30	14.8	17.6	20.4	-29	
	35	—	17.7	—	-30	
	40	—	15.7	—	-27	
	43.5	—	10.0	—	-24	
Gain Flatness	22-40		0.9		—	dB
Directivity	22-43.5		28		—	dB
Input Return Loss	22		10		3	dB
	25		17		6	
	30		16		5	
	35		12		3	
	40		9		5	
	43.5		8		5	
Output Return Loss	22		13		9	dB
	25		14		8	
	30		18		9	
	35		9		7	
	40		7		4	
	43.5		9		9	
Output Power @1dB compression AMP-ON	22		1.2		—	dBm
	25		1.8		—	
	30		4.1		—	
	35		6.4		—	
	40		7.8		—	
	43.5		8.2		—	
Output IP3 (P _{out} =-10dBm/tone)	22		10.1		—	dBm
	25		10.1		—	
	30		12.7		—	
	35		16.7		—	
	40		15.5		—	
	43.5		15.9		—	
Device Operating Voltage (V _{DD})		3.8	4.0	4.2	4.0	V
Device Operating Current (I _d)		—	22	36	3	mA
Control Voltage (V _G)		3.8	4.0	4.2	0	V
Control Voltage (I _G)			8		2	mA
DC Current (I _d) Variation Vs. Temperature ²			-15		—	μA/°C
DC Current (I _d) Variation Vs. Voltage			0.006		—	mA/mV
Thermal Resistance			51.9		—	°C/W

1 Measured on Mini-Circuits Characterization test board TB-TSS-44+. See Characterization Test Circuit (Fig. 1)
 2 (Current at 85°C - Current at -45°C)/130

MAXIMUM RATINGS³

Parameter	Ratings
Operating Temperature (ground lead)	-40°C to 85°C
Storage Temperature	-55°C to 100°C
Total Power Dissipation	0.94W
Input Power	19dBm (5 min. max), 8dBm (continuous)
DC Voltage V _{DD} ⁴ (Pad 11)	6V
DC Voltage V _G ⁵ (Pad 12)	5V

3 Permanent damage may occur if these limits are exceeded.
 4 Measured by keeping V_G=0V.
 5 Measured by keeping V_{DD}=5V.

CONTROL VOLTAGE (V_G) FIG. 1

	Min.	Typ.	Max.	Units
Amplifier-ON	3.8	4	4.2	V
Amplifier-OFF	—	0	0.2	V





SWITCHING SPECIFICATIONS (RISE/FALL TIME)

Parameter		Min.	Typ.	Max.	Units
Amplifier ON to Shutdown	OFF TIME (50% Control to 10% RF)	—	9.8	—	μs
	FALL TIME (90 to 10% RF)	—	9.2	—	
Amplifier Shutdown to ON	ON TIME (50% Control to 90% RF)	—	11.2	—	μs
	RISE TIME (10% to 90% RF)	—	10.7	—	
Control Voltage Leakage		—	2.0	—	mV

SIMPLIFIED SCHEMATIC AND PAD DESCRIPTION

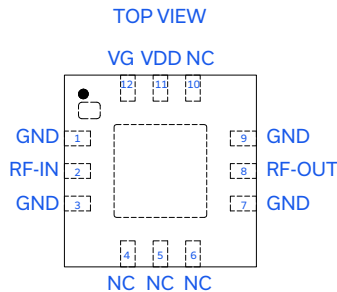
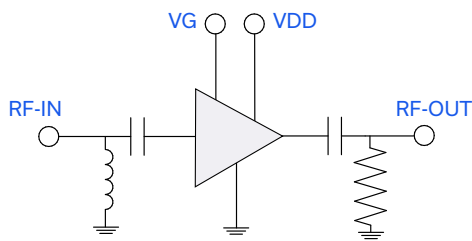

Function	Pad Number	Description (See Application Circuit, Fig. 1)
RF-IN	2	RF input pad
RF-OUT	8	RF output pad
V _{DD}	11	DC power supply (V _{DD})
GND	1,3,7,9	Connected to ground.
V _G	12	Control voltage for shutdown(V _G)
NC	4,5,6,10	No internal connection. Recommended usage per PCB layer PL-616



CHARACTERIZATION TEST CIRCUIT / RECOMMENDED APPLICATION CIRCUIT

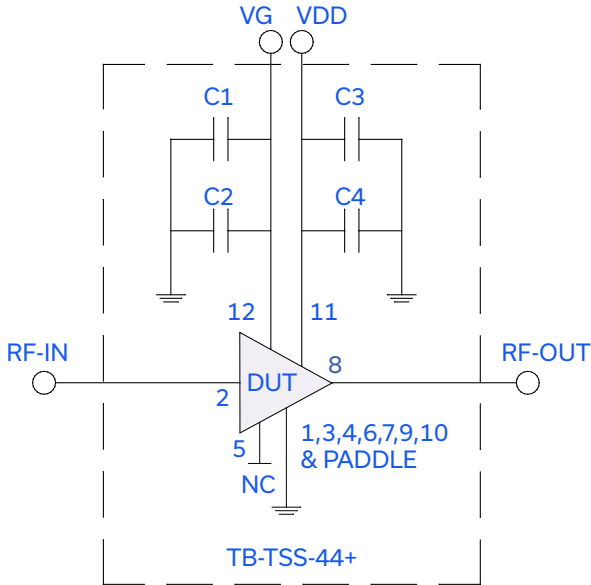

Component	Size	Value	Part Number	Manufacturer
C1,C3	0402	0.1uF	GRM155R71C104KA88D	Murata
C2,C4	0402	100pF	GRM1555C1H101JA01J	Murata

Fig 1. Block diagram of Test Circuit used for characterization. (DUT soldered on Mini-Circuits Characterization test board TB-TSS-44+)

Gain, Return loss, Output power at 1dB compression (P1dB) , output IP3 (OIP3) and noise figure measured using Agilent's N5244A PNA-X microwave network analyzer.

Conditions:

1. Gain and Return loss: Pin= -25dBm
2. Output IP3 (OIP3): Two tones, spaced 1 MHz apart, -10dBm/tone at output.
3. Switching Time:
RF Signal: Pin=-25dBm, fRF=22GHz
Vdd=4VDC, VG=Pulse Signal at 1kHz with Vhigh=4V, Vlow=0V & 50% duty cycle

PRODUCT MARKING



Marking may contain other features or characters for internal lot control



ADDITIONAL DETAILED TECHNICAL INFORMATION IS AVAILABLE ON OUR DASH BOARD. TO ACCESS [CLICK HERE](#)

Performance Data	Data Table Swept Graphs S-Parameter (S2P Files) Data Set (.zip file)
Case Style	DQ1225 Plastic package, exposed paddle lead finish: Matte-Tin
Tape & Reel Standard quantities available on reel	F66 7" reels with 20, 50, 100, 200, 500, 1K, or 2K devices
Suggested Layout for PCB Design	PL-616
Evaluation Board	TB-TSS-44+
Environmental Ratings	ENV08T1

ESD RATING

Human Body Model (HBM): 0 (Pass 200V) in accordance with ANSI/ESD STM 5.1 - 2001

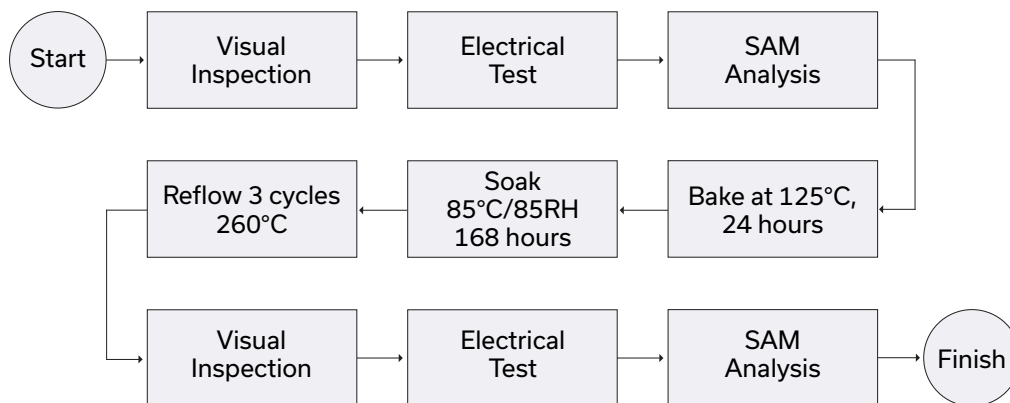

MSL FLOW CHART



- NOTES**
- A. Performance and quality attributes and conditions not expressly stated in this specification document are intended to be excluded and do not form a part of this specification document.
 - B. Electrical specifications and performance data contained in this specification document are based on Mini-Circuit's applicable established test performance criteria and measurement instructions.
 - C. The parts covered by this specification document are subject to Mini-Circuits standard limited warranty and terms and conditions (collectively, "Standard Terms"); Purchasers of this part are entitled to the rights and benefits contained therein. For a full statement of the standard. Terms and the exclusive rights and remedies thereunder, please visit Mini-Circuits' website at www.minicircuits.com/MCLStore/terms.jsp

Looking for pricing, stock, or lifecycle information?

Click below to explore more details on WIN SOURCE:

-  [View TSS-44+ on WIN SOURCE](#)
-  [Mini-Circuits Information](#)

Optimize Your Supply Chain with WIN SOURCE Solutions

-  Global Sourcing Solution
-  Obsolete Management
-  Cost Control Management
-  Shortage Management
-  Alternative Solution
-  Excess Inventory Management