

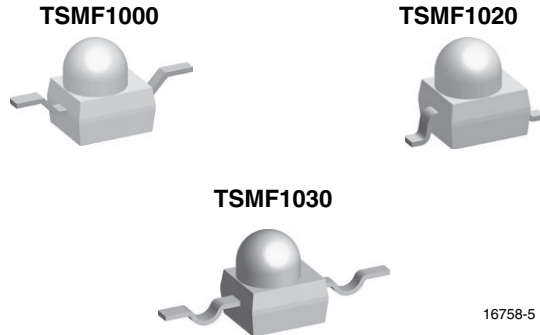



## High Speed Infrared Emitting Diode, RoHS-Compliant, 890 nm, Surface Emitter Technology



### FEATURES

- Package type: surface-mount
- Package form: GW, RGW, yoke
- Dimensions (L x W x H in mm): 2.5 x 2 x 2.7
- Peak wavelength:  $\lambda_p = 890 \text{ nm}$
- High radiant power
- Angle of half intensity:  $\phi = \pm 11^\circ$
- Low forward voltage
- Suitable for high pulse current operation
- Package matches with detector TEMD1000
- Floor life: 168 h, MSL 3, according to J-STD-020
- Material categorization: for definitions of compliance please see [www.vishay.com/doc?99912](http://www.vishay.com/doc?99912)



**RoHS**  
COMPLIANT

### DESCRIPTION

TSMF1000 series are infrared, 890 nm emitting diodes based on surface emitter chip technology with high radiant power and high speed, molded in clear, untinted plastic packages (with lens) for surface mounting (SMD).

### APPLICATIONS

- IrDA compatible data transmission
- Miniature light barrier
- Photointerrupters
- Optical switch
- Control and drive circuits
- Shaft encoders

| PRODUCT SUMMARY |               |            |                  |            |
|-----------------|---------------|------------|------------------|------------|
| COMPONENT       | $I_e$ (mW/sr) | $\phi$ (°) | $\lambda_p$ (nm) | $t_r$ (ns) |
| TSMF1000        | 27            | $\pm 11$   | 890              | 15         |
| TSMF1020        | 27            | $\pm 11$   | 890              | 15         |
| TSMF1030        | 27            | $\pm 11$   | 890              | 15         |

#### Note

- Test conditions see table "Basic Characteristics"

| ORDERING INFORMATION |               |                              |                  |
|----------------------|---------------|------------------------------|------------------|
| ORDERING CODE        | PACKAGING     | REMARKS                      | PACKAGE FORM     |
| TSMF1000             | Tape and reel | MOQ: 1000 pcs, 1000 pcs/reel | Reverse gullwing |
| TSMF1020             | Tape and reel | MOQ: 1000 pcs, 1000 pcs/reel | Gullwing         |
| TSMF1030             | Tape and reel | MOQ: 1000 pcs, 1000 pcs/reel | Yoke             |

#### Note

- MOQ: minimum order quantity



| ABSOLUTE MAXIMUM RATINGS (T <sub>amb</sub> = 25 °C, unless otherwise specified) |  |                   |             |      |
|---|--|-------------------|-------------|------|
| PARAMETER   | TEST CONDITION                                   | SYMBOL            | VALUE       | UNIT |
| Reverse voltage   |  | V <sub>R</sub>    | 5           | V    |
| Forward current   |  | I <sub>F</sub>    | 100         | mA   |
| Peak forward current  | t <sub>p</sub> /T = 0.5, t <sub>p</sub> = 100 μs | I <sub>FM</sub>   | 200         | mA   |
| Surge forward current   | t <sub>p</sub> = 100 μs                          | I <sub>FSM</sub>  | 1           | A    |
| Power dissipation   |  | P <sub>V</sub>    | 190         | mW   |
| Junction temperature  |  | T <sub>J</sub>    | 100         | °C   |
| Ambient temperature range   |  | T <sub>amb</sub>  | -40 to +85  | °C   |
| Storage temperature range   |  | T <sub>stg</sub>  | -40 to +100 | °C   |
| Soldering temperature   | t ≤ 5 s  | T <sub>sd</sub>   | 260         | °C   |
| Thermal resistance junction to ambient  | JESD51   | R <sub>thJA</sub> | 250         | K/W  |

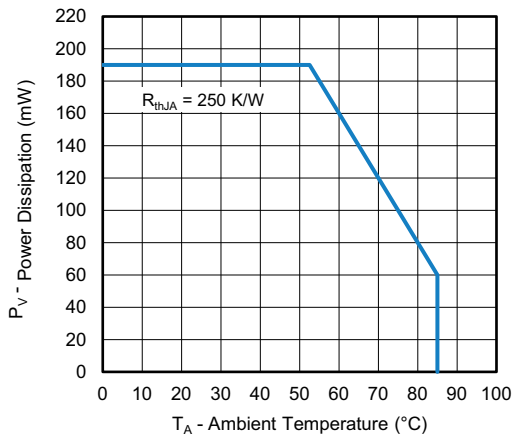

Fig. 1 - Power Dissipation vs. Ambient Temperature

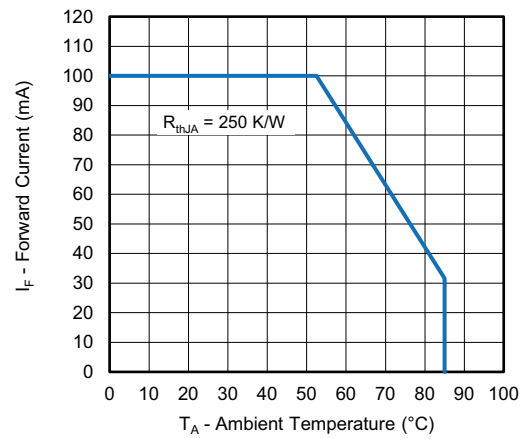

Fig. 2 - Forward Current vs. Ambient Temperature

| BASIC CHARACTERISTICS (T <sub>amb</sub> = 25 °C, unless otherwise specified) |  |                             |                                    |      |      |       |
|--|--|-----------------------------|------------------------------------|------|------|-------|
| PARAMETER  | TEST CONDITION                                   | SYMBOL                      | MIN.                               | TYP. | MAX. | UNIT  |
| Forward voltage  | I <sub>F</sub> = 20 mA                           | V <sub>F</sub>              | -                                  | 1.3  | 1.5  | V     |
|  | I <sub>F</sub> = 100 mA, t <sub>p</sub> = 100 μs | V <sub>F</sub>              | -                                  | 1.5  | -    | V     |
|  | I <sub>F</sub> = 1 A, t <sub>p</sub> = 100 μs    | V <sub>F</sub>              | -                                  | 2.6  | -    | V     |
| Temperature coefficient of V <sub>F</sub>                                    | I <sub>F</sub> = 20 mA                           | TK <sub>V<sub>F</sub></sub> | -                                  | -1.4 | -    | mV/K  |
| Reverse current  |  | I <sub>R</sub>              | Not designed for reverse operation |      |      | μA    |
| Junction capacitance   | V <sub>R</sub> = 0 V, f = 1 MHz, E = 0           | C <sub>j</sub>              | -                                  | 56   | -    | pF    |
| Radiant intensity  | I <sub>F</sub> = 20 mA                           | I <sub>e</sub>              | 15                                 | 27   | 40   | mW/sr |
|  | I <sub>F</sub> = 100 mA, t <sub>p</sub> = 100 μs | I <sub>e</sub>              | -                                  | 155  | -    | mW/sr |
| Radiant power  | I <sub>F</sub> = 20 mA, t <sub>p</sub> = 20 ms   | φ <sub>e</sub>              | -                                  | 10   | -    | mW    |
| Temperature coefficient of φ <sub>e</sub>                                    | I <sub>F</sub> = 20 mA                           | TKφ <sub>e</sub>            | -                                  | -0.3 | -    | %/K   |
| Angle of half intensity  |  | φ                           | -                                  | ± 11 | -    | °     |
| Peak wavelength  | I <sub>F</sub> = 20 mA                           | λ <sub>p</sub>              | -                                  | 890  | -    | nm    |
| Spectral bandwidth   | I <sub>F</sub> = 20 mA                           | Δλ                          | -                                  | 35   | -    | nm    |
| Temperature coefficient of λ <sub>p</sub>                                    | I <sub>F</sub> = 20 mA                           | TKλ <sub>p</sub>            | -                                  | 0.3  | -    | nm/K  |
| Rise time  | I <sub>F</sub> = 20 mA                           | t <sub>r</sub>              | -                                  | 15   | -    | ns    |
| Fall time  | I <sub>F</sub> = 20 mA                           | t <sub>f</sub>              | -                                  | 15   | -    | ns    |

**BASIC CHARACTERISTICS** ( $T_{amb} = 25\text{ }^{\circ}\text{C}$ , unless otherwise specified)

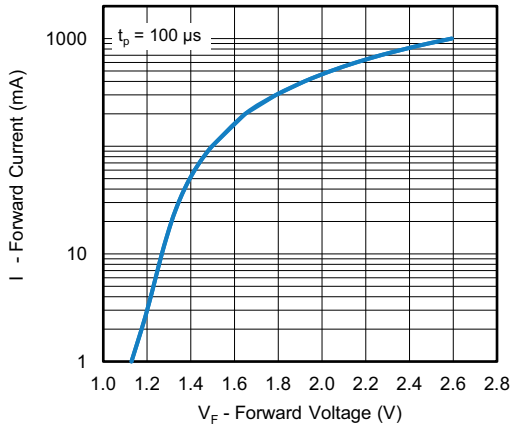

Fig. 3 - Forward Current vs. Forward Voltage

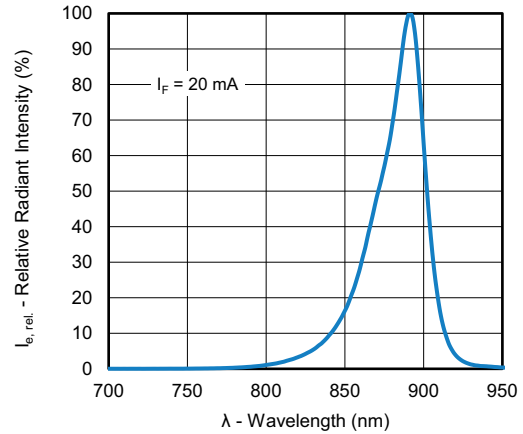

Fig. 6 - Relative Radiant Intensity vs. Wavelength

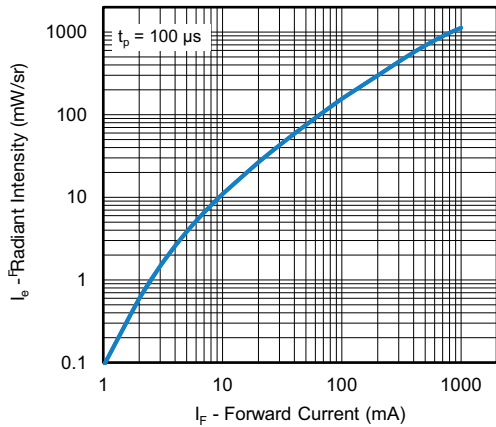

Fig. 4 - Radiant Intensity vs. Forward Current

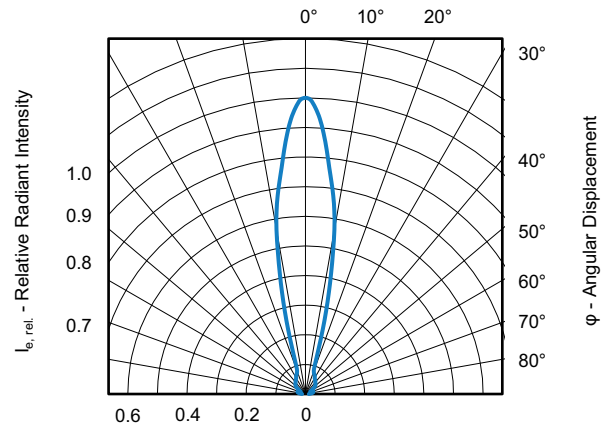

Fig. 7 - Relative Radiant Intensity vs. Angular Displacement

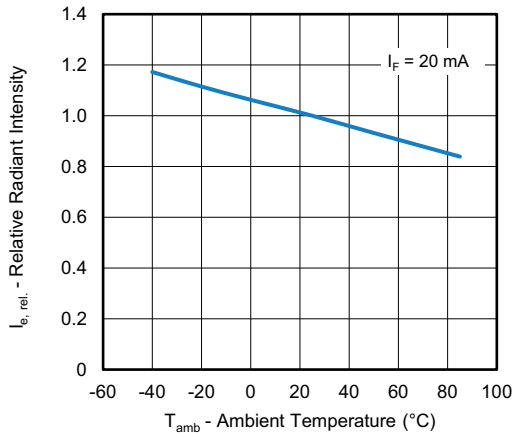

Fig. 5 - Relative Radiant Intensity vs. Ambient Temperature

**PRECAUTIONS FOR USE**

**1. Over-Current-Proof**

Customer must apply resistors for protection, otherwise slight voltage shift will cause big current change (burn out will happen).

**2. Storage**

- Storage temperature and rel. humidity conditions are: 5 °C to 35 °C, R.H. 60 %.
- Floor life must not exceed 168 h, according to JEDEC® level 3, J-STD-020.  
Once the package is opened, the products should be used within a week. Otherwise, they should be kept in a damp proof box with desiccant. Considering tape life, we suggest to use products within one year from production date.
- If opened more than one week in an atmosphere 5 °C to 35 °C, R.H. 60 %, devices should be treated at 60 °C ± 5 °C for 15 h.
- If humidity indicator in the package shows pink color (normal blue), then devices should be treated with the same conditions as 2.3.

**REFLOW SOLDER PROFILE**

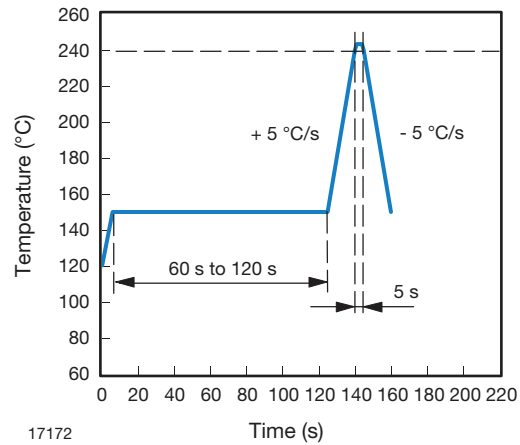

Fig. 8 - Lead Tin (SnPb) Reflow Solder Profile

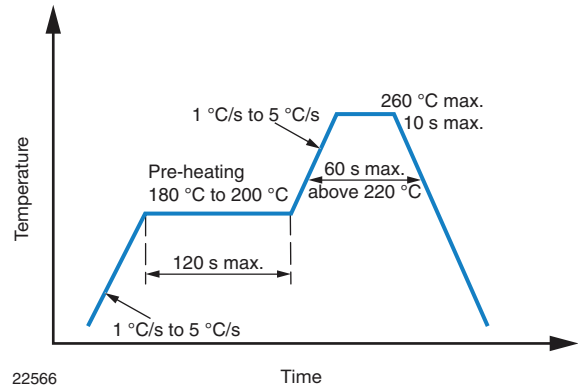
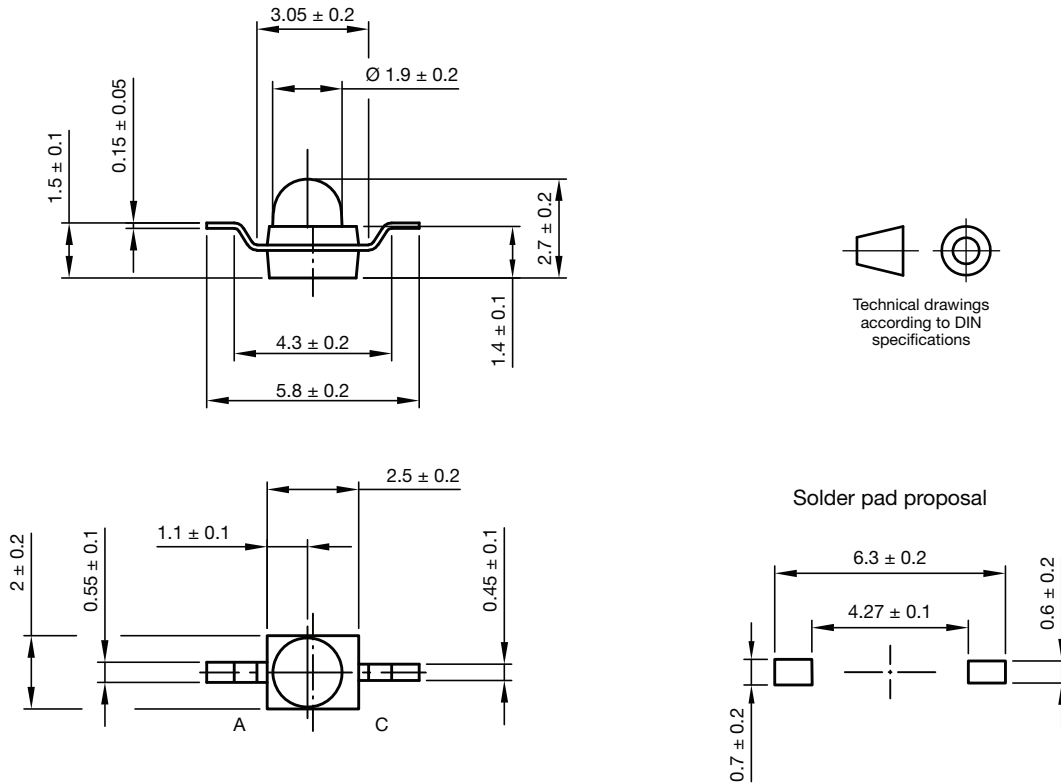

Fig. 9 - Lead (Pb)-Free Reflow Solder Profile According to J-STD-020



## PACKAGE DIMENSIONS in millimeters: TSMF1000



Drawing-No.: 6.544-5326.03-4  
Issue: 1; 15.09.2021

## PACKAGE DIMENSIONS in millimeters: TSMF1020

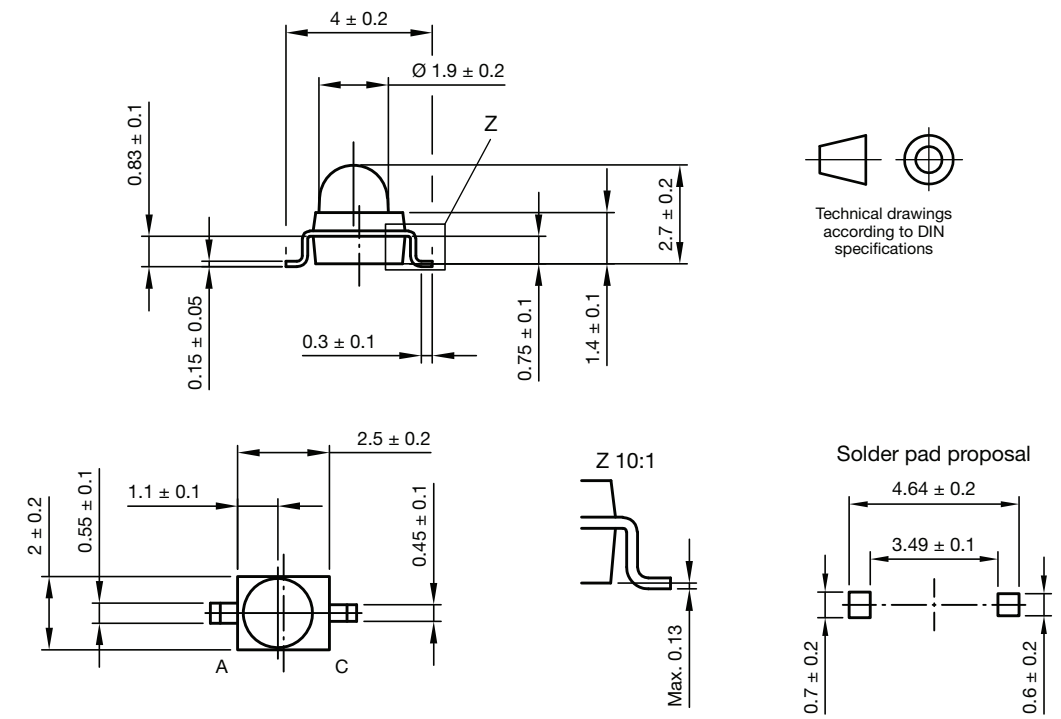

Drawing-No.: 6.544-5325.03-4  
Issue: 1; 15.09.2021



## PACKAGE DIMENSIONS in millimeters: TSMF1030

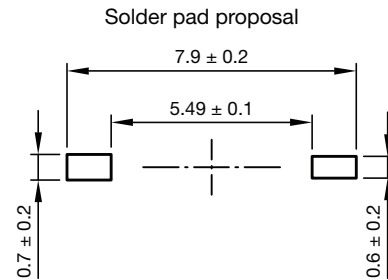
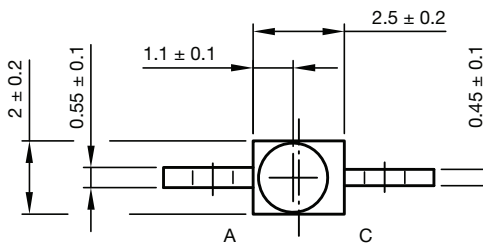
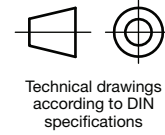
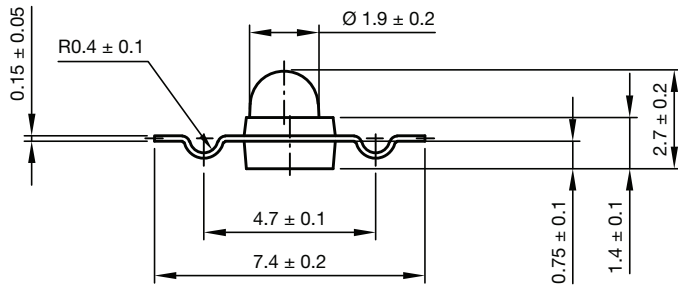

Drawing-No.: 6.544-5329.03-4  
Issue: 1; 15.09.2021

## REEL DIMENSIONS in millimeters

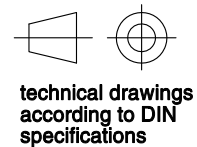
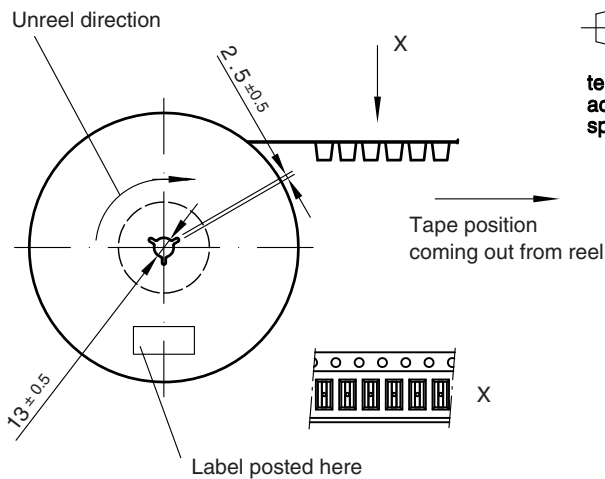
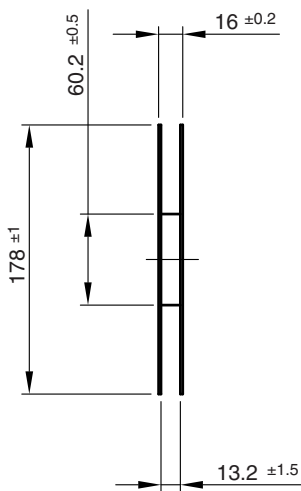

### Leader and trailer tape:

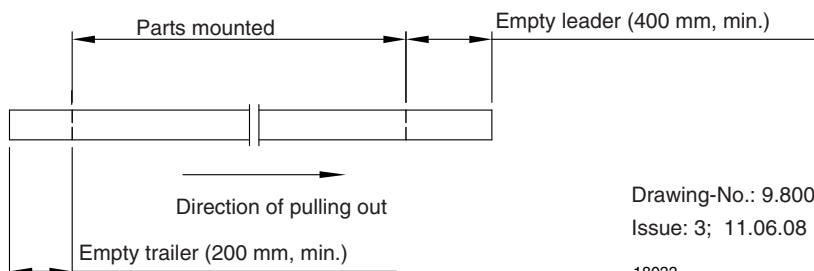

Drawing-No.: 9.800-5080.01-4  
Issue: 3; 11.06.08

18033



## TAPING DIMENSIONS in millimeters: TSMF1000

Dimension of tape:

Polarity and orientation in the tape:

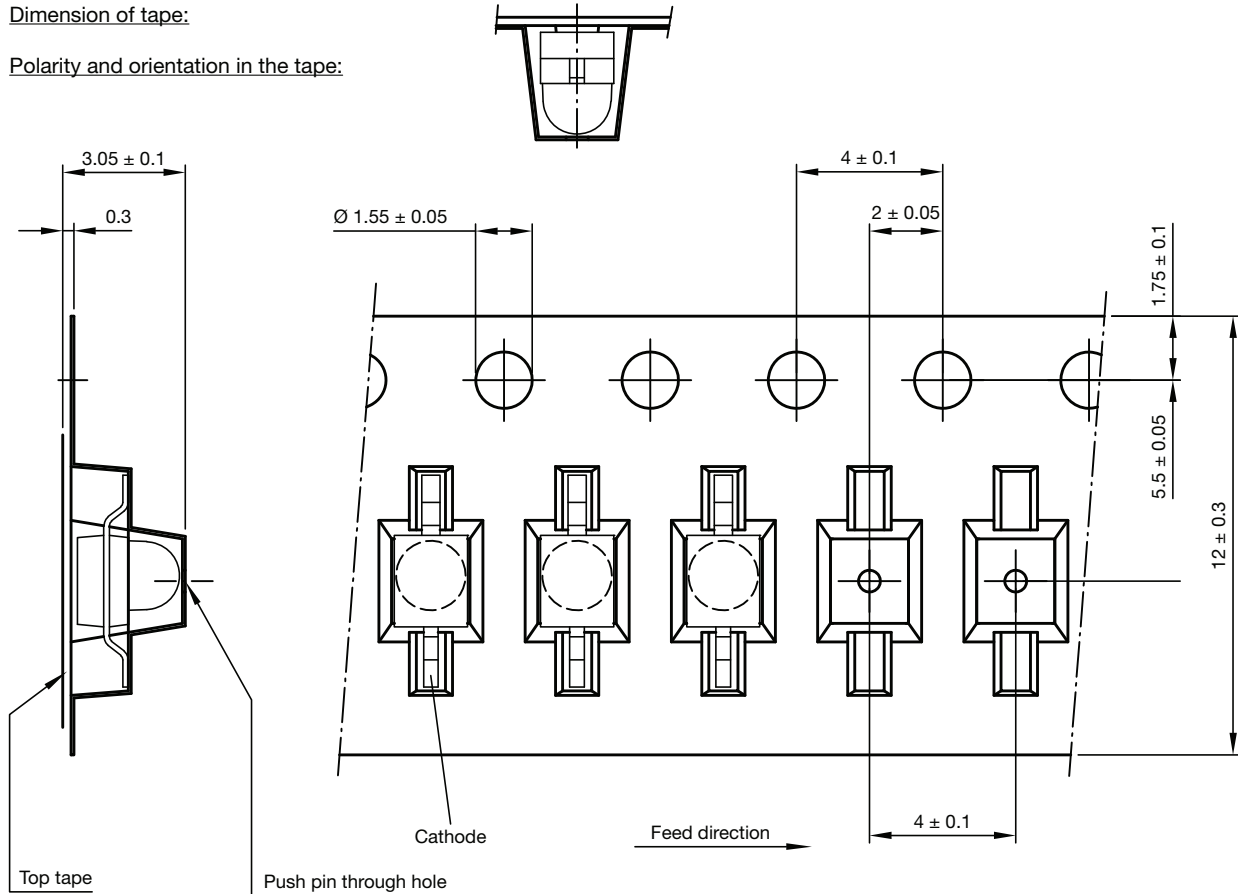

Quantity per reel: 1000 pieces

Drawing-No.: 9.700-5268.02-4  
Issue: 1; 28.09.2021

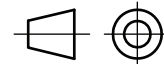

Technical drawings according to DIN specifications

## TAPING DIMENSIONS in millimeters: TSMF1020

Dimension of tape:

Polarity and orientation in the tape:

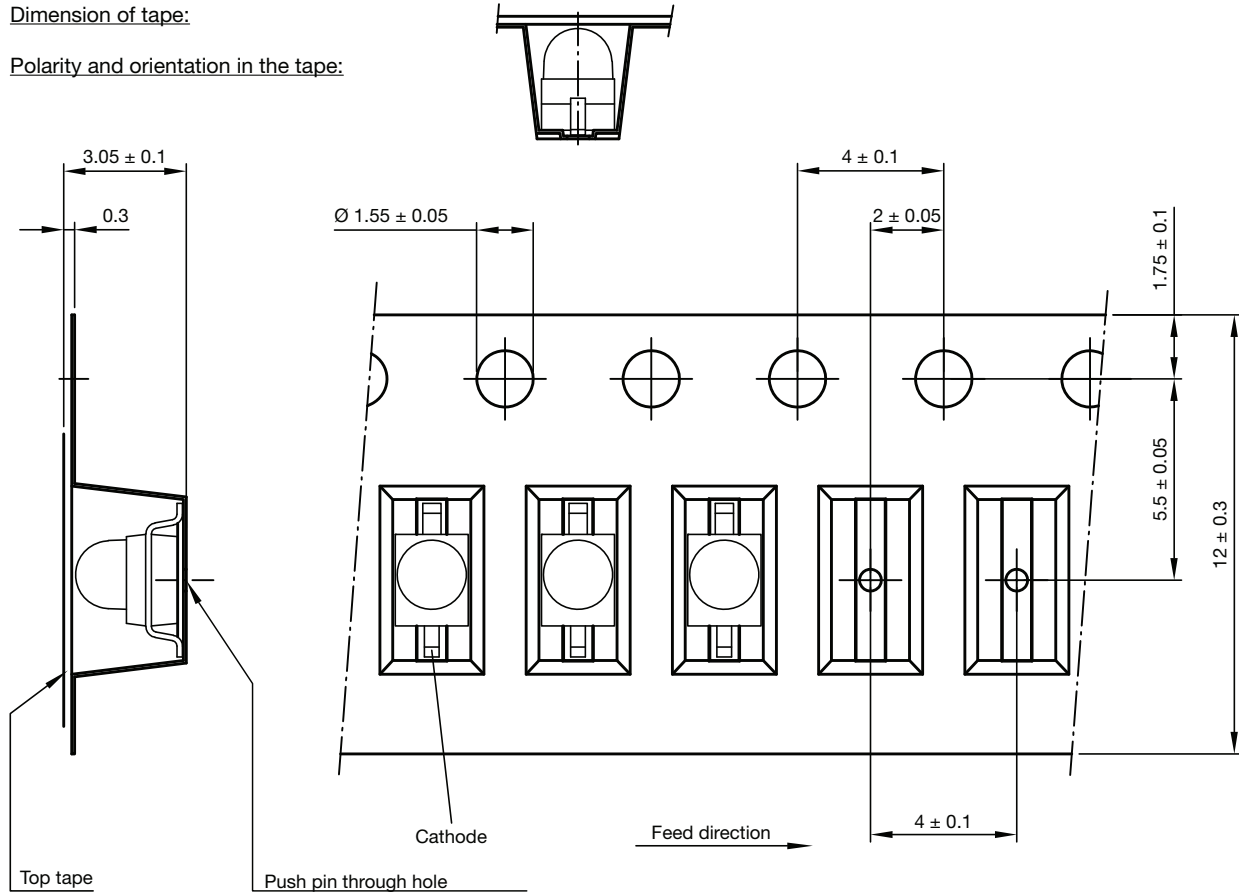

Quantity per reel: 1000 pieces

Drawing-No.: 9.700-5269.02-4  
Issue: 1; 28.09.2021

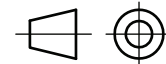

Technical drawings according to DIN specifications



## TAPING DIMENSIONS in millimeters: TSMF1030

Dimension of tape:

Polarity and orientation in the tape:

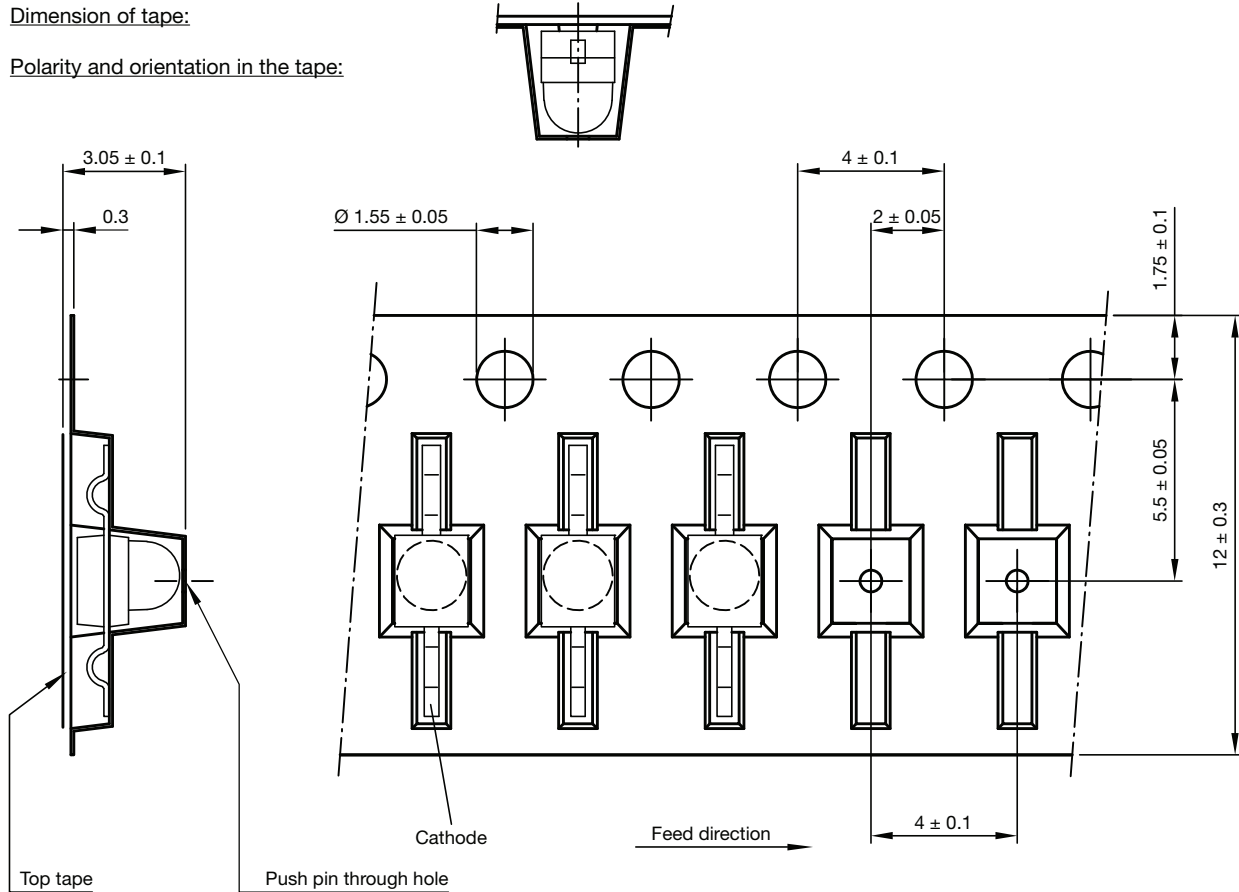

Quantity per reel: 1000 pieces

Drawing-No.: 9.700-5270.02-4  
Issue: 1; 28.09.2021

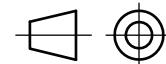

Technical drawings according to DIN specifications



## Disclaimer

ALL PRODUCT, PRODUCT SPECIFICATIONS AND DATA ARE SUBJECT TO CHANGE WITHOUT NOTICE TO IMPROVE RELIABILITY, FUNCTION OR DESIGN OR OTHERWISE.

Vishay Intertechnology, Inc., its affiliates, agents, and employees, and all persons acting on its or their behalf (collectively, "Vishay"), disclaim any and all liability for any errors, inaccuracies or incompleteness contained in any datasheet or in any other disclosure relating to any product.

Vishay makes no warranty, representation or guarantee regarding the suitability of the products for any particular purpose or the continuing production of any product. To the maximum extent permitted by applicable law, Vishay disclaims (i) any and all liability arising out of the application or use of any product, (ii) any and all liability, including without limitation special, consequential or incidental damages, and (iii) any and all implied warranties, including warranties of fitness for particular purpose, non-infringement and merchantability.

Statements regarding the suitability of products for certain types of applications are based on Vishay's knowledge of typical requirements that are often placed on Vishay products in generic applications. Such statements are not binding statements about the suitability of products for a particular application. It is the customer's responsibility to validate that a particular product with the properties described in the product specification is suitable for use in a particular application. Parameters provided in datasheets and / or specifications may vary in different applications and performance may vary over time. All operating parameters, including typical parameters, must be validated for each customer application by the customer's technical experts. Product specifications do not expand or otherwise modify Vishay's terms and conditions of purchase, including but not limited to the warranty expressed therein.

Hyperlinks included in this datasheet may direct users to third-party websites. These links are provided as a convenience and for informational purposes only. Inclusion of these hyperlinks does not constitute an endorsement or an approval by Vishay of any of the products, services or opinions of the corporation, organization or individual associated with the third-party website. Vishay disclaims any and all liability and bears no responsibility for the accuracy, legality or content of the third-party website or for that of subsequent links.

Except as expressly indicated in writing, Vishay products are not designed for use in medical, life-saving, or life-sustaining applications or for any other application in which the failure of the Vishay product could result in personal injury or death. Customers using or selling Vishay products not expressly indicated for use in such applications do so at their own risk. Please contact authorized Vishay personnel to obtain written terms and conditions regarding products designed for such applications.

No license, express or implied, by estoppel or otherwise, to any intellectual property rights is granted by this document or by any conduct of Vishay. Product names and markings noted herein may be trademarks of their respective owners.

## Looking for pricing, stock, or lifecycle information?

Click below to explore more details on WIN SOURCE:

 [View TSMF1030 on WIN SOURCE](#)

 [Vishay Information](#)

## Optimize Your Supply Chain with WIN SOURCE Solutions

-  Global Sourcing Solution
-  Obsolete Management
-  Cost Control Management
-  Shortage Management
-  Alternative Solution
-  Excess Inventory Management