



THE DATASHEET OF TPSMC36CA



TPSMC Series

Surface Mount - 1500W

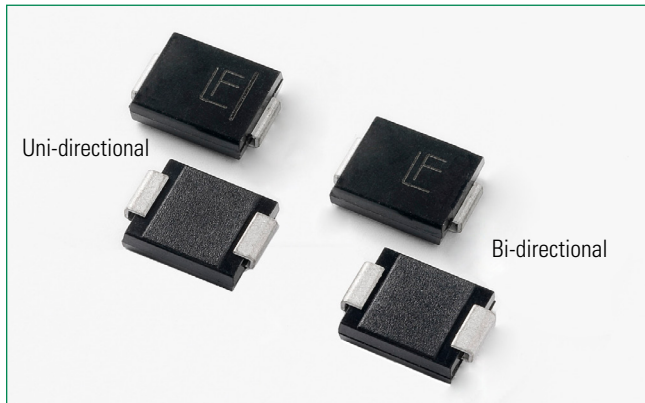

Agency Approvals

Agency	Agency File Number
	E230531

Maximum Ratings & Thermal Characteristics

($T_A=25^\circ\text{C}$ unless otherwise noted)

Parameter	Symbol	Value	Unit
Peak Pulse Power Dissipation by 10/1000 μs Waveform (Fig.2)(Note 1), (Note 2)	P_{PPM}	1500	W
Power Dissipation on Infinite Heat Sink at $T_A=50^\circ\text{C}$	$P_{M(AV)}$	6.5	W
Peak Forward Surge Current, 8.3ms Single Half Sine Wave (Note 3)	I_{FSM}	200	A
Maximum Instantaneous Forward Voltage at 100A for Unidirectional Only	V_F	3.5	V
Operating Junction and Storage Temperature Range	T_J, T_{STG}	-65 to 150	$^\circ\text{C}$
Typical Thermal Resistance Junction to Lead	$R_{\theta JL}$	15	$^\circ\text{C/W}$
Typical Thermal Resistance Junction to Ambient	$R_{\theta JA}$	75	$^\circ\text{C/W}$

Notes:

- Non-repetitive current pulse per Fig. 4 and derated above $T_A = 25^\circ\text{C}$ per Fig. 3.
- Mounted on copper pad area of 0.31x0.31" (8.0 x 8.0mm) to each terminal.
- Measured on 8.3ms single half sine wave or equivalent square wave for unidirectional device only, duty cycle=4 per minute maximum.

Functional Diagram

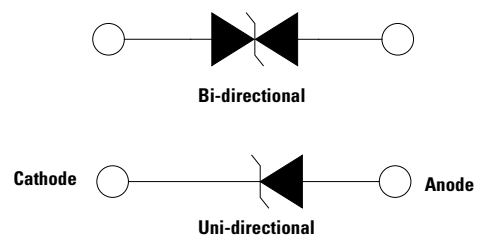

Description

The TPSMC series is designed specifically to protect sensitive electronic equipment from voltage transients induced by lightning and other transient voltage events.

Features

- High reliability application and automotive grade AEC-Q101 qualified
- For surface mounted applications to optimize board space
- Low profile package
- Typical failure mode is short from over-specified voltage or current
- Whisker test is conducted based on JEDEC JESD201A per its table 4a and 4c
- IEC 61000-4-2 ESD 30kV(Air), 30kV (Contact)
- ESD protection of data lines in accordance with IEC 61000-4-2
- EFT protection of data lines in accordance with IEC 61000-4-4
- Built-in strain relief
- $V_{BR} @ T_J = V_{BR} @ 25^\circ\text{C} \times (1 + \alpha T \times (T_J - 25))$ (α : Temperature Coefficient)
- Glass passivated chip junction
- 1500W peak pulse power capability at 10/1000 μs waveform, repetition rate (duty cycles):0.01%
- Fast response time: typically less than 1.0ps from 0V to V_{BR} min
- Excellent clamping capability
- Low incremental surge resistance
- Typical I_R less than 1 μA above 13V
- High temperature soldering guaranteed: 260 $^\circ\text{C}$ /10 seconds at terminals
- UL Recognized body that meets flammability rating V-0
- Meet MSL level1, per J-STD-020, high temperature soldering guaranteed.
- Matte tin lead-free plated
- Halogen free and RoHS compliant
- Pb-free E3 means 2nd level interconnect is Pb-free and the terminal finish material is tin(Sn) (IPC/JEDEC J-STD-609A.01)
- UL Recognized to ANSI/UL 497B: Protectors for Data Communications and Fire-Alarm Circuits

Applications

TVS Components are ideal for the protection of I/O Interfaces, V_{CC} bus and other vulnerable circuits used in Telecom, Computer, Industrial and Consumer electronic applications.

TPSMC Series

Surface Mount - 1500W

Electrical Characteristics

Part Number (Uni)	Part Number (Bi)	Marking		Reverse Stand off Voltage V_R (Volts)	Breakdown Voltage V_{BR} (Volts) @ I_T		Test Current I_T (mA)	Maximum Clamping Voltage V_C @ I_{pp} (V)	Maximum Peak Pulse Current I_{pp} (A)	Maximum Reverse Leakage I_R @ V_R (μ A)	Agency Approval 
		UNI	BI		MIN	MAX					
TPSMC12A	TPSMC12CA	12AA	12CA	10.20	11.40	12.60	1	16.7	91.0	5	X
TPSMC13A	TPSMC13CA	13AA	13CA	11.10	12.40	13.70	1	18.2	83.5	1	X
TPSMC15A	TPSMC15CA	15AA	15CA	12.80	14.30	15.80	1	21.2	71.7	1	X
TPSMC16A	TPSMC16CA	16AA	16CA	13.60	15.20	16.80	1	22.5	67.6	1	X
TPSMC18A	TPSMC18CA	18AA	18CA	15.30	17.10	18.90	1	25.2	60.3	1	X
TPSMC20A	TPSMC20CA	20AA	20CA	17.10	19.00	21.00	1	27.7	54.9	1	X
TPSMC22A	TPSMC22CA	22AA	22CA	18.80	20.90	23.10	1	30.6	49.7	1	X
TPSMC24A	TPSMC24CA	24AA	24CA	20.50	22.80	25.20	1	33.2	45.8	1	X
TPSMC27A	TPSMC27CA	27AA	27CA	23.10	25.70	28.40	1	37.5	40.5	1	X
TPSMC30A	TPSMC30CA	30AA	30CA	25.60	28.50	31.50	1	41.4	36.7	1	X
TPSMC33A	TPSMC33CA	33AA	33CA	28.20	31.40	34.70	1	45.7	33.3	1	X
TPSMC36A	TPSMC36CA	36AA	36CA	30.80	34.20	37.80	1	49.9	30.5	1	X
TPSMC39A	TPSMC39CA	39AA	39CA	33.30	37.10	41.00	1	53.9	28.2	1	X
TPSMC43A	TPSMC43CA	43AA	43CA	36.80	40.90	45.20	1	59.3	25.6	1	X
TPSMC47A	TPSMC47CA	47AA	47CA	40.20	44.70	49.40	1	64.8	23.5	1	X
TPSMC51A	TPSMC51CA	51AA	51CA	43.60	48.50	53.60	1	70.1	21.7	1	X
TPSMC56A	TPSMC56CA	56AA	56CA	47.80	53.20	58.80	1	77.0	19.7	1	X
TPSMC62A	TPSMC62CA	62AA	62CA	53.00	58.90	65.10	1	85.0	17.9	1	X
TPSMC68A	TPSMC68CA	68AA	68CA	58.10	64.60	71.40	1	92.0	16.5	1	X
TPSMC75A	TPSMC75CA	75AA	75CA	64.10	71.30	78.80	1	103.0	14.8	1	X
TPSMC82A	TPSMC82CA	82AA	82CA	70.10	77.90	86.10	1	113.0	13.5	1	X
TPSMC91A	TPSMC91CA	91AA	91CA	77.80	86.50	95.50	1	125.0	12.2	1	X
TPSMC100A	TPSMC100CA	100AA	100CA	85.50	95.00	105.26	1	137.0	11.1	1	X
TPSMC110A	TPSMC110CA	110AA	110CA	94.50	104.50	115.79	1	152.0	10	1	X
TPSMC120A	TPSMC120CA	120AA	120CA	102.60	114.00	126.32	1	165.0	9.2	1	X
TPSMC130A	TPSMC130CA	130AA	130CA	111.15	123.50	136.84	1	179.0	8.5	1	X
TPSMC150A	TPSMC150CA	150AA	150CA	128.25	142.50	157.89	1	207.0	7.3	1	X
TPSMC160A	TPSMC160CA	160AA	160CA	136.80	152.00	168.42	1	219.0	6.9	1	X
TPSMC170A	TPSMC170CA	170AA	170CA	145.35	161.50	178.95	1	234.0	6.5	1	X
TPSMC180A	TPSMC180CA	180AA	180CA	153.90	171.00	189.47	1	246.0	6.2	1	X
TPSMC200A	TPSMC200CA	200AA	200CA	171.00	190.00	210.53	1	274.0	5.5	1	X
TPSMC220A	TPSMC220CA	220AA	220CA	188.10	209.00	231.58	1	328.0	4.6	1	X
TPSMC250A	TPSMC250CA	250AA	250CA	213.75	237.50	263.16	1	344.0	4.4	1	X

For bidirectional type having V_R of 10 volts and less, the I_R limit is double.

I-V Curve Characteristics

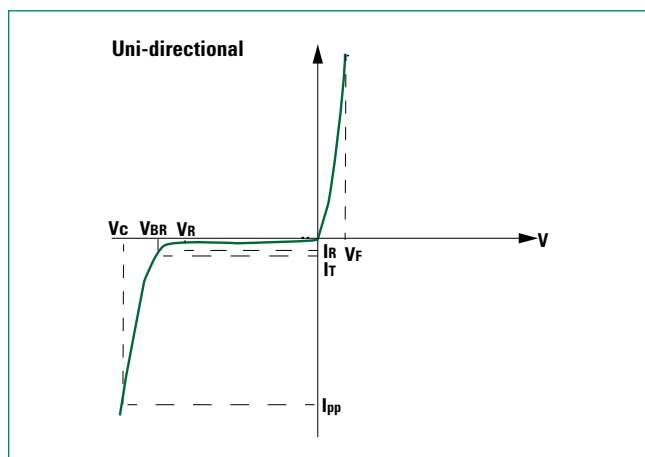

P_{PPM} **Peak Pulse Power Dissipation** -- Max power dissipation
 V_R **Stand-off Voltage** -- Maximum voltage that can be applied to the TVS without operation
 V_{BR} **Breakdown Voltage** -- Maximum voltage that flows though the TVS at a specified test current (I_T)

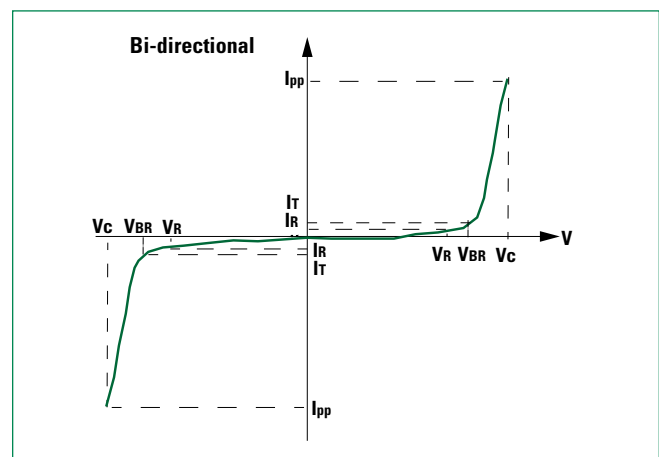

V_C **Clamping Voltage** -- Peak voltage measured across the TVS at a specified I_{ppm} (peak impulse current)
 I_R **Reverse Leakage Current** -- Current measured at V_R
 V_F **Forward Voltage Drop for Uni-directional**

TPSMC Series

Surface Mount - 1500W

Ratings and Characteristic Curves ($T_A=25^{\circ}\text{C}$ unless otherwise noted)

Figure 1 - TVS Transients Clamping Waveform

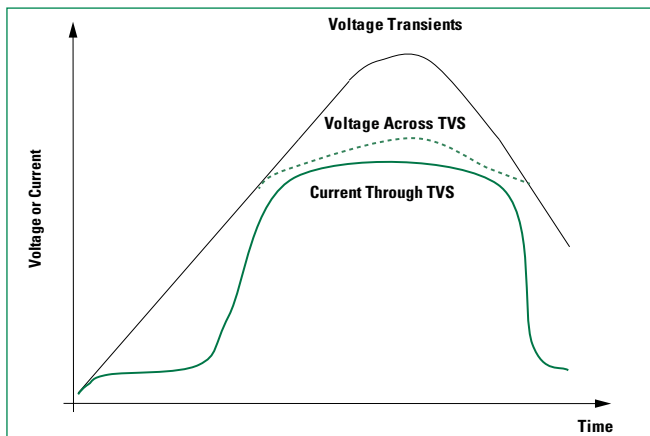

Figure 2 - Peak Pulse Power Rating

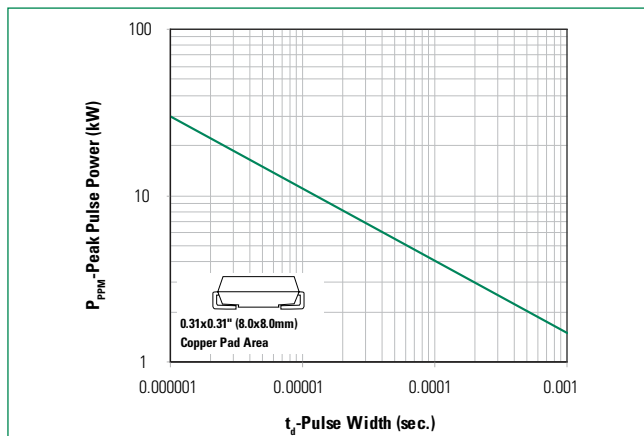

Figure 3 - Peak Pulse Power Derating Curve

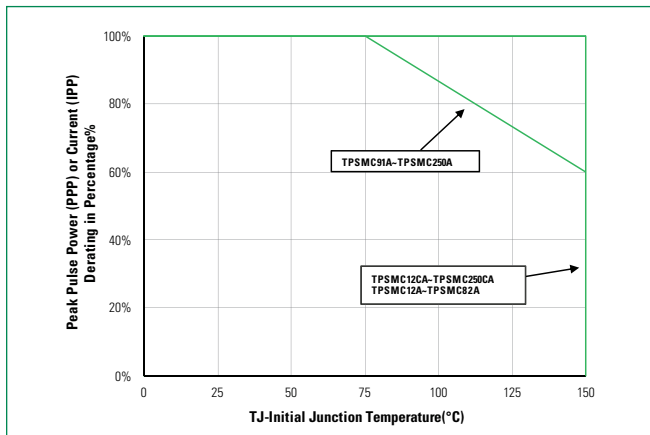

Figure 4 - Pulse Waveform

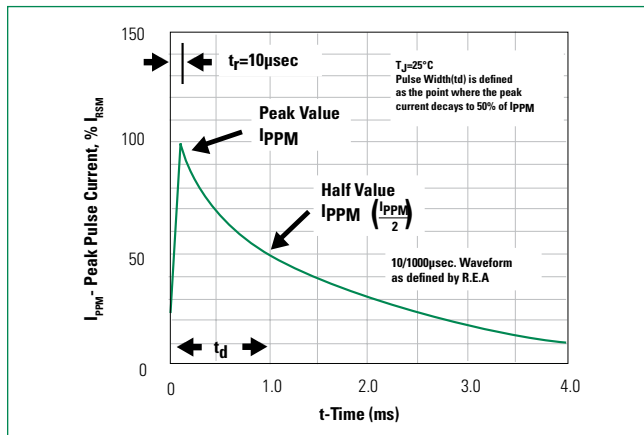

Figure 5 - Typical Junction Capacitance

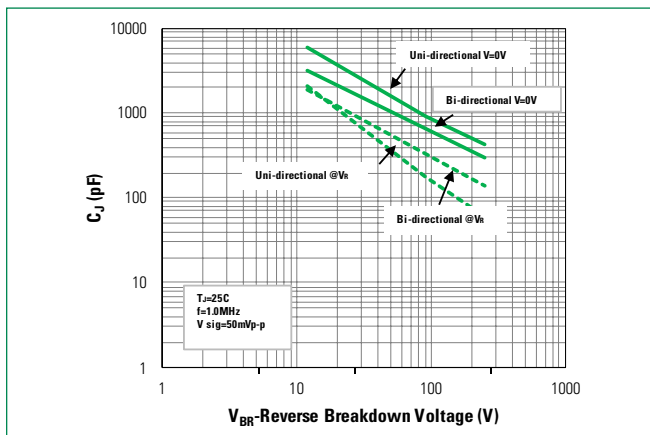
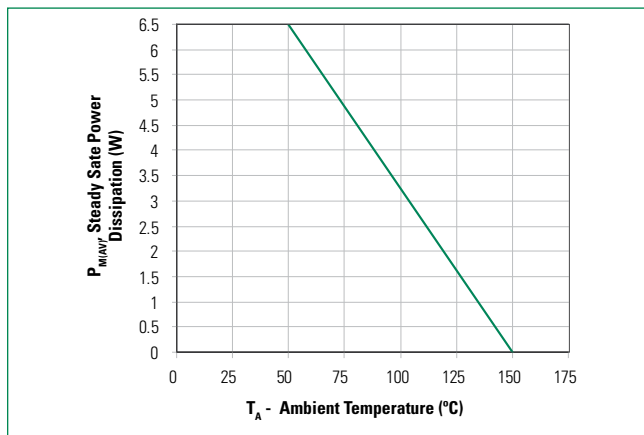

Figure 6 - Steady State Power Dissipation Derating Curve



TPSMC Series

Surface Mount - 1500W

Figure 7 - Maximum Non-Repetitive Peak Forward Surge Current Uni-Directional Only

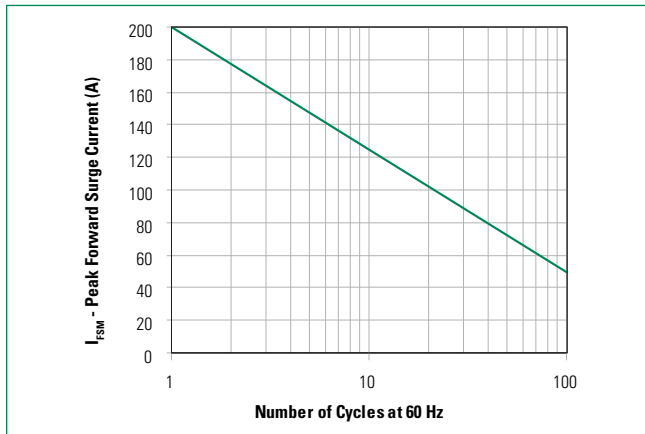

Physical Specifications

Weight	0.007 ounce, 0.21 grams
Case	JEDEC DO214AB. Molded plastic body over glass passivated junction
Polarity	Color band denotes positive end (cathode) except Bidirectional.
Terminal	Matte Tin-plated leads, Solderable per JESD22-B102

Environmental Specifications

High Temp. Storage	JESD22-A103
HTRB	JESD22-A108
Temperature Cycling	JESD22-A104
MSL	JEDEC-J-STD-020, Level 1
H3TRB	JESD22-A101
RSH	JESD22-A111

Soldering Parameters

Reflow Condition	Lead-free assembly	
Pre Heat	- Temperature Min ($T_{s(min)}$)	150°C
	- Temperature Max ($T_{s(max)}$)	200°C
	- Time (min to max) (t_s)	60 – 120 secs
Average ramp up rate (Liquidus Temp (T_L) to peak)	3°C/second max	
$T_{s(max)}$ to T_L - Ramp-up Rate	3°C/second max	
Reflow	- Temperature (T_L) (Liquidus)	217°C
	- Time (min to max) (t_r)	60 – 150 seconds
Peak Temperature (T_p)	260 ^{+0/-5} °C	
Time within 5°C of actual peak Temperature (t_p)	30 seconds max	
Ramp-down Rate	6°C/second max	
Time 25°C to peak Temperature (T_p)	8 minutes max.	
Do not exceed	260°C	

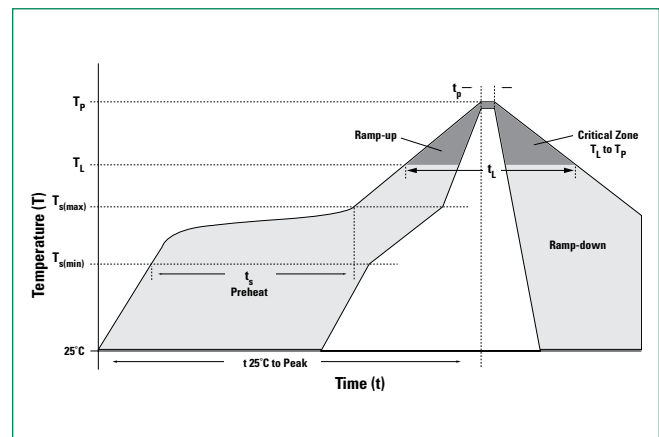

Dimensions

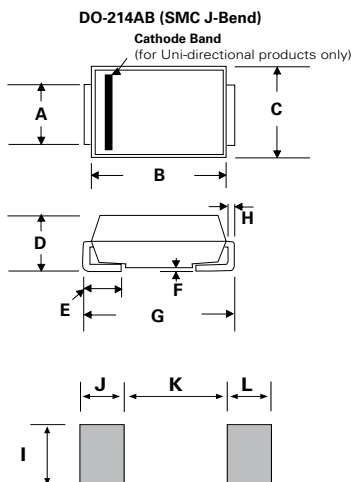

Dimensions	Inches		Millimeters	
	Min	Max	Min	Max
A	0.114	0.126	2.900	3.200
B	0.260	0.280	6.600	7.110
C	0.220	0.245	5.590	6.220
D	0.079	0.103	2.060	2.620
E	0.030	0.060	0.760	1.520
F	-	0.008	-	0.203
G	0.305	0.320	7.750	8.130
H	0.006	0.012	0.152	0.305
I	0.129	-	3.300	-
J	0.094	-	2.400	-
K	-	0.165	-	4.200
L	0.094	-	2.400	-

TPSMC Series

Surface Mount - 1500W

Part Numbering System

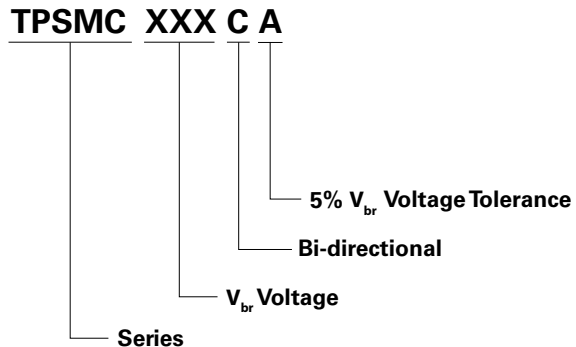

Part Marking System

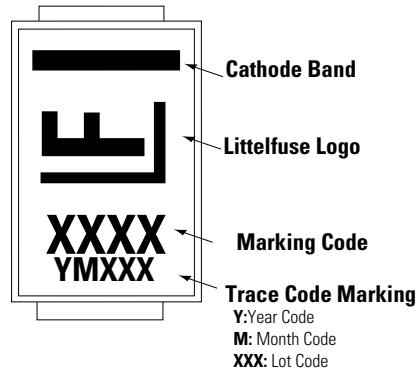

Packaging

Part number	Component Package	Quantity	Packaging Option	Packaging Specification
TPSMCxxxXX	DO-214AB	3000	Tape & Reel - 16mm tape/13" reel	EIA STD RS-481

Tape and Reel Specification

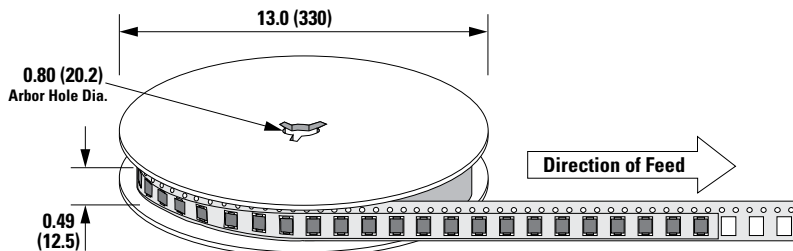
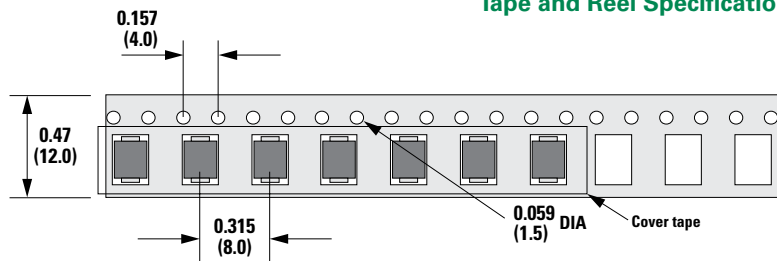

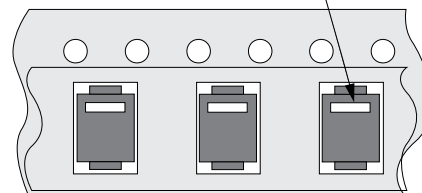

Cathode Mark For Unidirectional Components



Disclaimer Notice - Information furnished is believed to be accurate and reliable. However, users should independently evaluate the suitability of and test each product selected for their own applications. Littelfuse products are not designed for, and may not be used in, all applications. Read complete Disclaimer Notice at <http://www.littelfuse.com/disclaimer-electronics>.

Looking for pricing, stock, or lifecycle information?

Click below to explore more details on WIN SOURCE:

-  [View TPSMC36CA on WIN SOURCE](#)
-  [Littelfuse Inc. Information](#)

Optimize Your Supply Chain with WIN SOURCE Solutions

-  Global Sourcing Solution
-  Obsolete Management
-  Cost Control Management
-  Shortage Management
-  Alternative Solution
-  Excess Inventory Management