

TOP267V TOPSwitch-JX Family

Integrated Off-Line Switcher with EcoSmart Technology
for Highly Efficient Power Supplies
Auto-Restart Protection Option

Product Highlights

EcoSmart™ – Energy Efficient

- Ideal for applications from 20 W to 44 W
- Energy efficient over entire load range
- No-load consumption below 100 mW at 265 VAC
- Up to 750 mW standby output power for 1 W input at 230 VAC

High Design Flexibility for Low System Cost

- Multi-mode PWM control maximizes efficiency at all loads
- 132 kHz operation reduces transformer and power supply size
 - 66 kHz option for highest efficiency requirements
- Accurate programmable current limit
- Optimized line feed-forward for line ripple rejection
- Frequency jittering reduces EMI filter cost
- Fully integrated soft-start for minimum start-up stress
- 725 V rated MOSFET
 - Simplifies meeting design derating requirements

Extensive Protection Features

- Auto-restart limits power delivery to <3% during overload faults
 - Output short-circuit protection (SCP)
 - Output over-current protection (OCP)
 - Output overload protection (OPP)
- Output overvoltage protection (OVP)
 - Hysteretic shutdown
 - Simple fast AC reset
 - Primary or secondary sensed
- Line undervoltage (UV) detection prevents turn-off glitches
- Line overvoltage (OV) shutdown extends line surge withstand
- Accurate thermal shutdown with large hysteresis (OTP)

Advanced Package Options

- eDIP™-12 package:
 - 43 W / 117 W universal input power output capability with PCB / metal heat sink
 - Low profile horizontal orientation for ultra-slim designs
 - Heat transfer to both PCB and heat sink
 - Optional external heat sink provides thermal impedance equivalent to a TO-220

Description

TOPSwitch™-JX cost effectively incorporates a 725 V power MOSFET, high-voltage switched current source, multi-mode PWM control, oscillator, thermal shutdown circuit, fault protection and other control circuitry onto a monolithic device.

Typical Applications

- Notebook or laptop adapter
- Generic adapter
- Printer
- LCD monitor
- Set-top box
- PC or LCD TV standby
- Audio amplifier

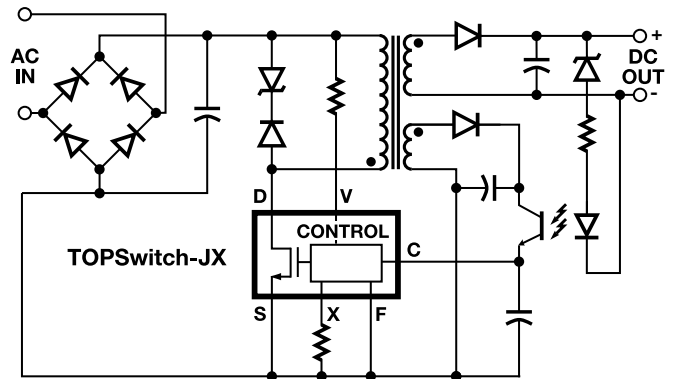

PI-5578-090309

Figure 1. Typical Flyback Application.



Figure 2. eDIP-12B (V Package).

Output Power Table

Product ⁴	PCB Copper Area ¹			
	230 VAC ±15%		85-265 VAC	
	Adapter ²	Open Frame ³	Adapter ²	Open Frame ³
TOP267V	27.5 W	44 W	19 W	32 W

Table 1. Output Power Table.

Notes:

1. See Key Application Considerations section for more details.
2. Maximum continuous power in a typical non-ventilated enclosed adapter measured at +50 °C ambient temperature.
3. Maximum continuous power in an open frame design at +50 °C ambient temperature.
5. Package: eDIP-12B.

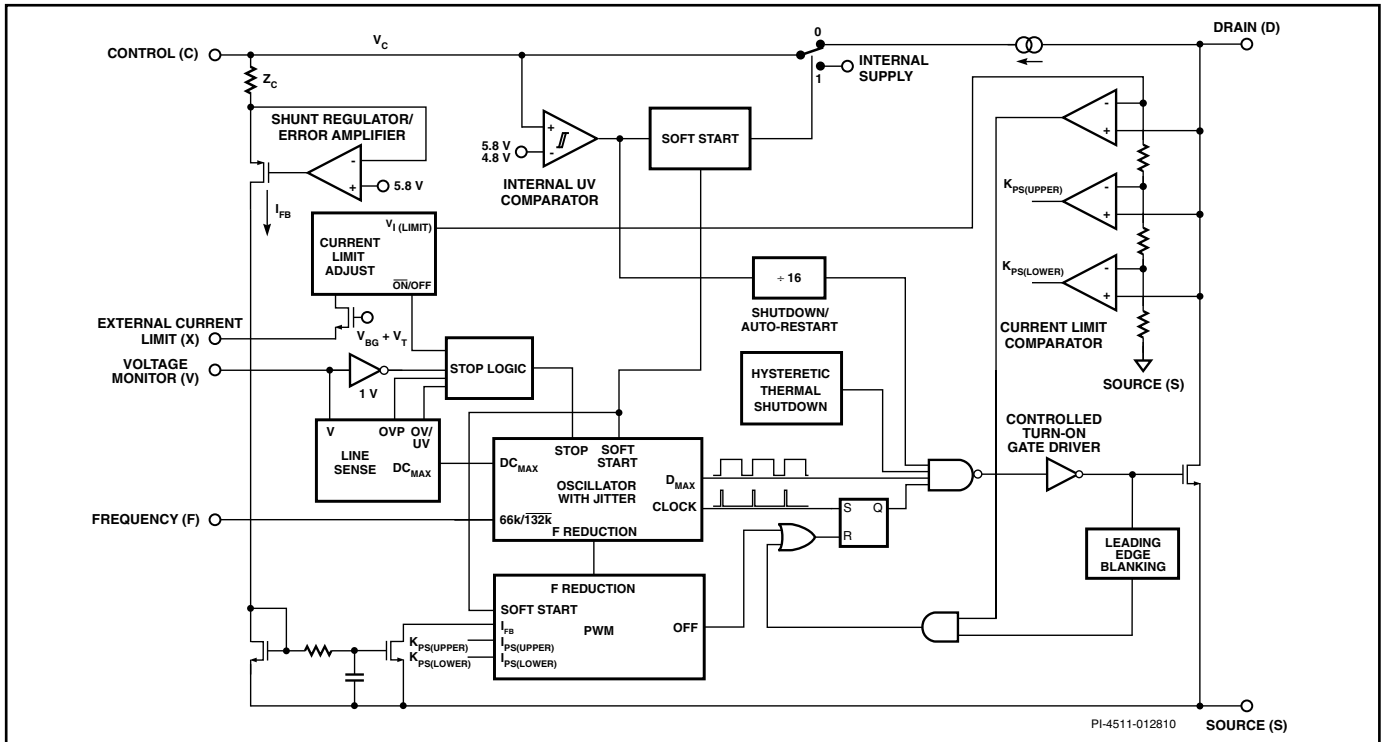

Figure 3. Functional Block Diagram.

Pin Functional Description

DRAIN (D) Pin:

High-voltage power MOSFET DRAIN pin. The internal start-up bias current is drawn from this pin through a switched high-voltage current source. Internal current limit sense point for drain current.

CONTROL (C) Pin:

Error amplifier and feedback current input pin for duty cycle control. Internal shunt regulator connection to provide internal bias current during normal operation. It is also used as the connection point for the supply bypass and auto-restart/compensation capacitor.

EXTERNAL CURRENT LIMIT (X) Pin:

Input pin for external current limit adjustment remote-ON/OFF and device reset. A connection to SOURCE pin disables all functions on this pin. This pin should not be left floating.

VOLTAGE MONITOR (V) Pin:

Input for OV, UV, line feed-forward with DC_{MAX} reduction, output overvoltage protection (OVP), remote-ON/OFF. A connection to the SOURCE pin disables all functions on this pin. This pin should not be left floating.

FREQUENCY (F) Pin:

Input pin for selecting switching frequency 132 kHz if connected to SOURCE pin and 66 kHz if connected to CONTROL pin. This pin should not be left floating.

SOURCE (S) Pin:

Output MOSFET source connection for high-voltage power return. Primary-side control circuit common and reference point.

NO CONNECTION (NC) Pin:

Internally not connected, floating potential pin.

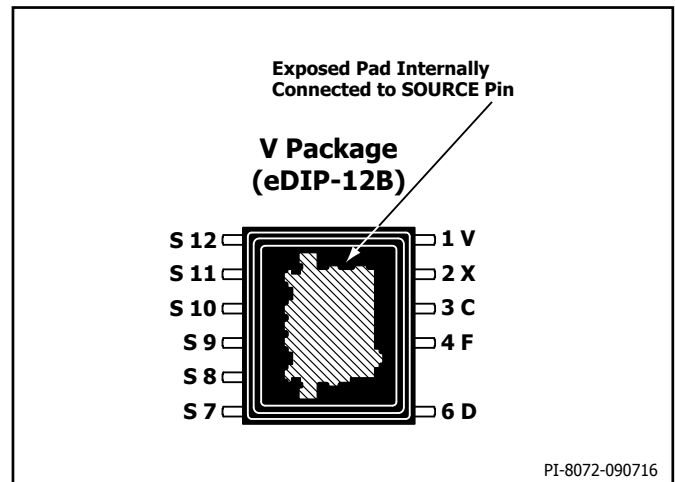
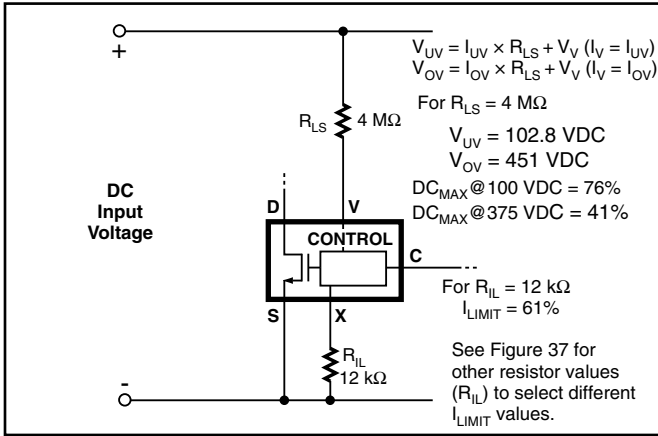

Figure 4. Pin Configuration (Top View).



PI-5579-111210

Figure 5. Package Line-Sense and Externally Set Current Limit.

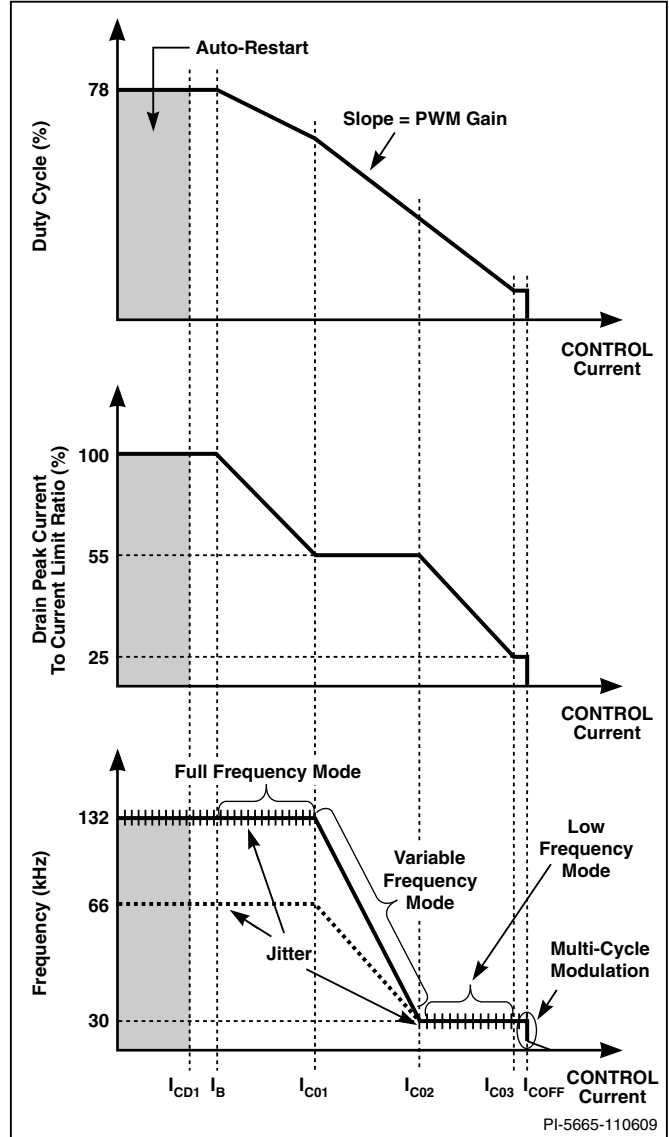

Figure 6. Control Pin Characteristics (Multi-Mode Operation).

Typical Uses of FREQUENCY (F) Pin

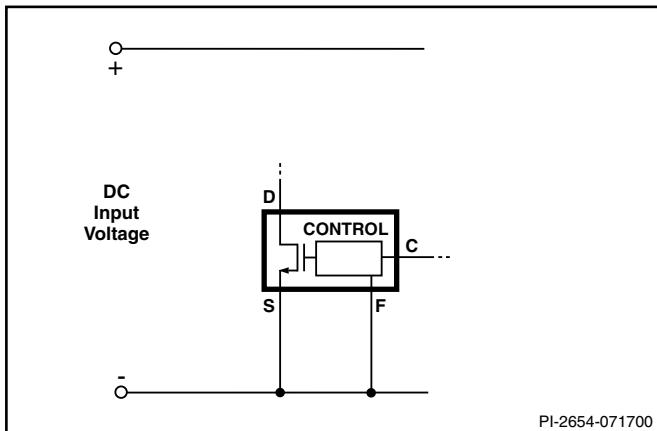

Figure 7. Full Frequency Operation (132 kHz).

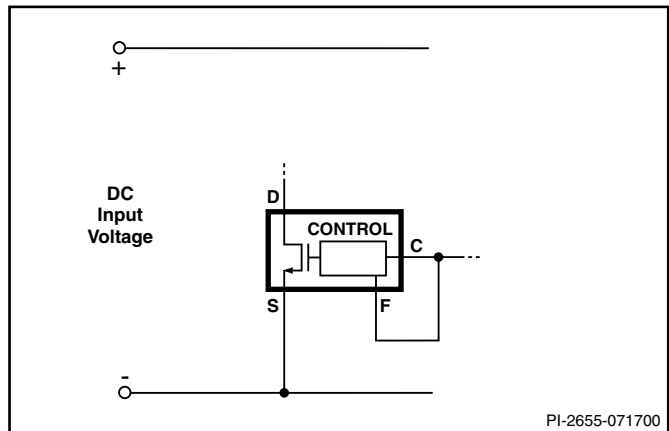

Figure 8. Half Frequency Operation (66 kHz).

Typical Uses of VOLTAGE MONITOR (V) and EXTERNAL CURRENT LIMIT (X) Pins

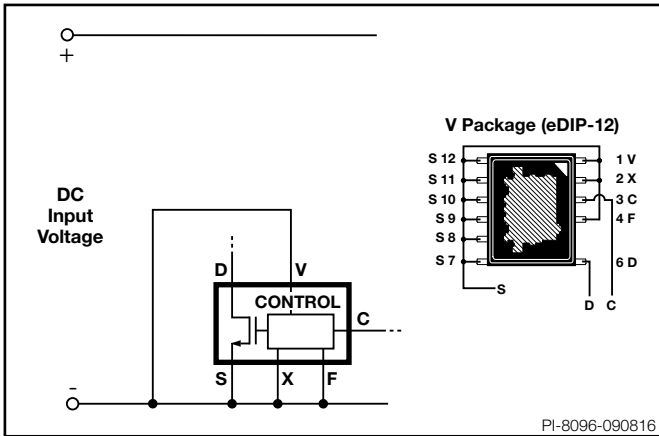

Figure 9. Three Terminal Operation (VOLTAGE MONITOR and EXTERNAL CURRENT LIMIT Features Disabled. FREQUENCY Pin Tied to SOURCE or CONTROL Pin.)

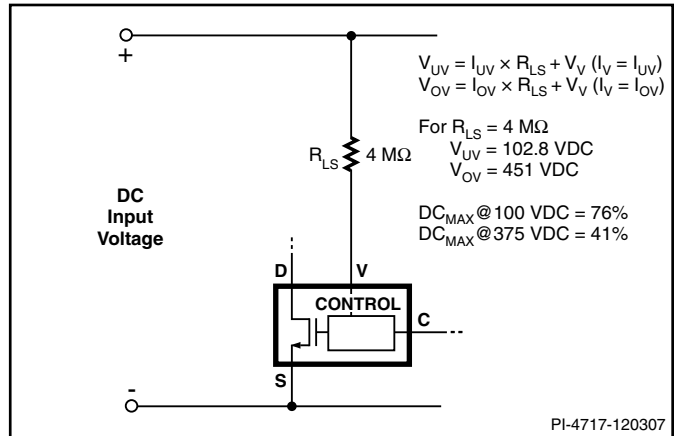

Figure 10. Line-Sensing for Undervoltage, Overvoltage and Line Feed-Forward.

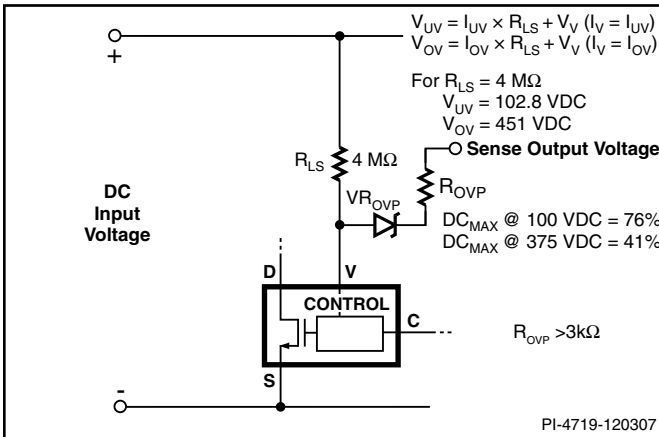

Figure 11. Line-Sensing for Undervoltage, Overvoltage, Line Feed-Forward and Hysteretic Output Overvoltage Protection.

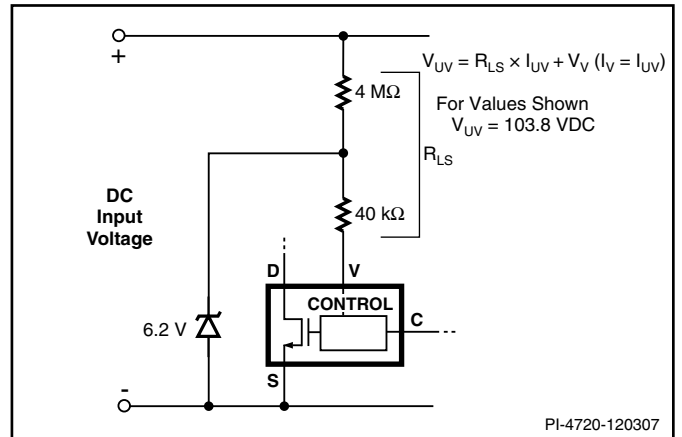

Figure 12. Line-Sensing for Undervoltage Only (Overvoltage Disabled).

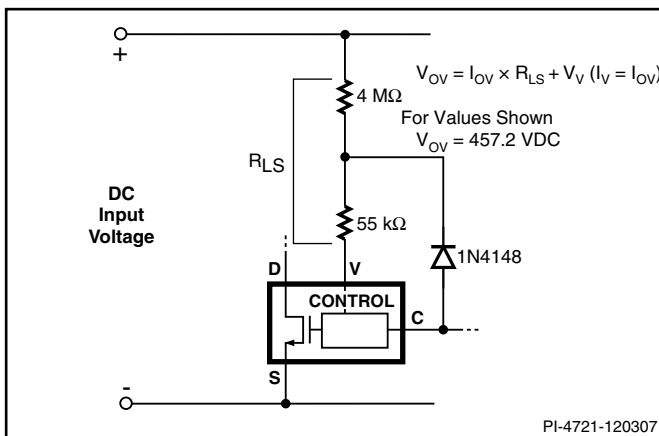

Figure 13. Line-Sensing for Overvoltage Only (Undervoltage Disabled). Maximum Duty Cycle Reduced at Low-Line and Further Reduction with Increasing Line Voltage.

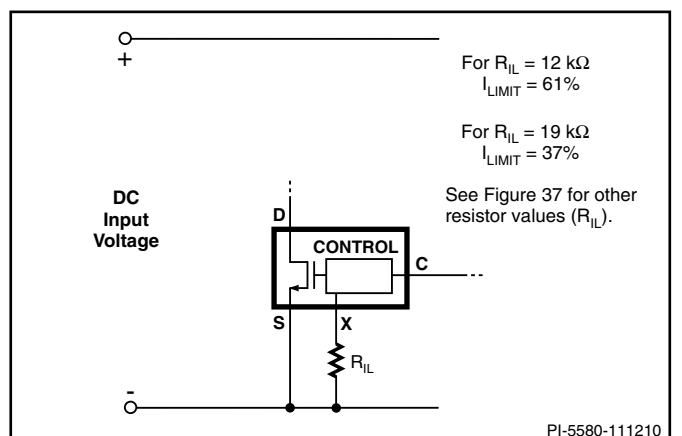

Figure 14. External Set Current Limit.

Typical Uses of VOLTAGE MONITOR (V) and EXTERNAL CURRENT LIMIT (X) Pins (cont.)

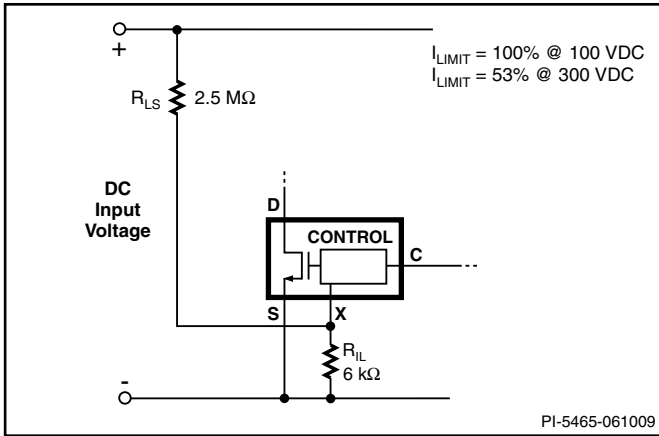

Figure 15. Current Limit Reduction with Line Voltage.

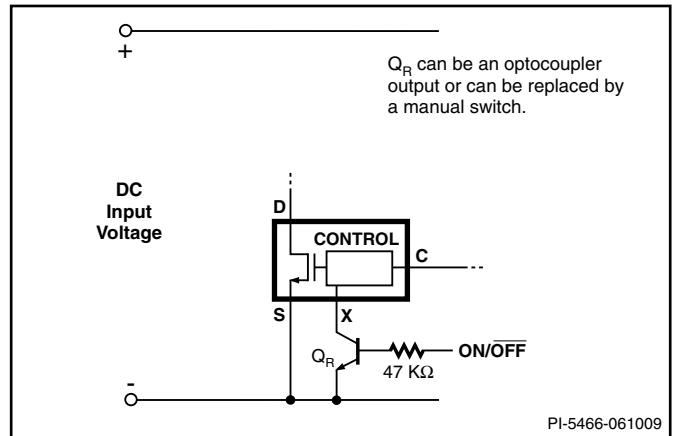

Figure 16. Active-On (Fail Safe) Remote-ON/OFF.

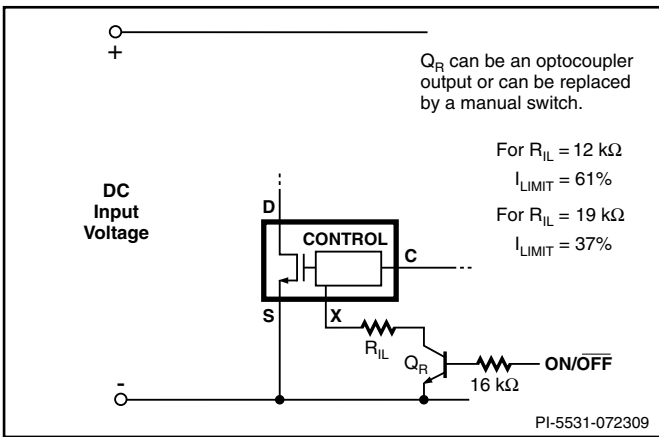

Figure 17. Active-On Remote-ON/OFF with Externally Set Current Limit.

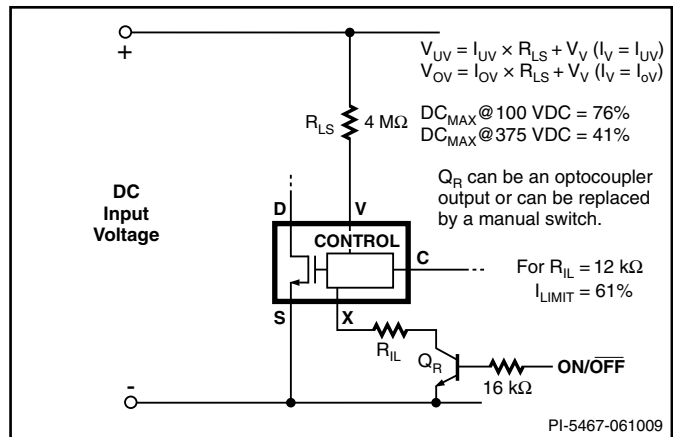

Figure 18. Active-On Remote-ON/OFF with Line-Sense and External Current Limit.

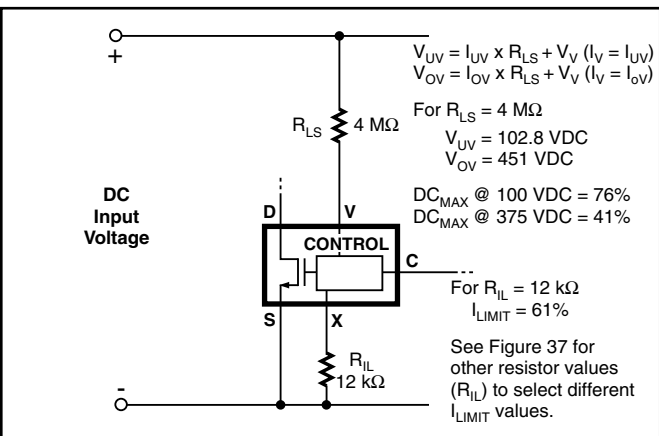

Figure 19. Line Sensing and Externally Set Current Limit.

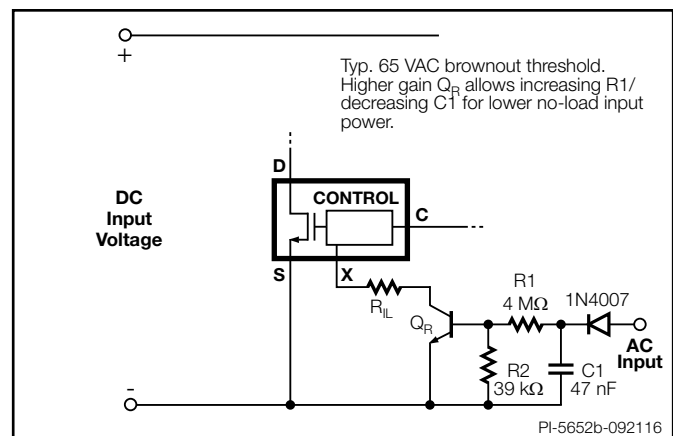

Figure 20. Externally Set Current Limit and Brown-Out.

Absolute Maximum Ratings⁽²⁾

DRAIN Pin Peak Voltage	-0.3 V to 725 V
DRAIN Pin Peak Current: TOP267	5.44 A
CONTROL Pin Voltage	-0.3 V to 9 V
CONTROL Pin Current	100 mA
VOLTAGE MONITOR Pin Voltage	-0.3 V to 9 V
CURRENT LIMIT Pin Voltage	-0.3 V to 4.5 V
FREQUENCY Pin Voltage	-0.3 V to 9 V
Storage Temperature	-65 °C to 150 °C
Operating Junction Temperature	-40 °C to 150 °C
Lead Temperature ⁽¹⁾	260 °C

Notes:

- 1/16 in. from case for 5 seconds.
- Maximum ratings specified may be applied one at a time without causing permanent damage to the product. Exposure to Absolute Maximum Rating conditions for extended periods of time may affect product reliability.

Thermal Resistance

Thermal Resistance: V Package

(θ_{JA})68 °C/W ⁽³⁾ , 58 °C/W ⁽⁴⁾
(θ_{JC})	2 °C/W ⁽²⁾

Notes:

- Free standing with no heat sink.
- Measured at the back surface of tab.
- Soldered (including exposed pad for K package) to typical application PCB with a heat sinking area of 0.36 sq. in. (232mm²), 2 oz. (610 g/m²) copper clad.
- Soldered (including exposed pad for K package) to typical application PCB with a heat sinking area of 1 sq. in. (645 mm²), 2 oz. (610 g/m²) copper clad.

Parameter	Symbol	Conditions		Min	Typ	Max	Units
		SOURCE = 0 V; T _J = -40 to 125 °C (Unless Otherwise Specified)					
Control Functions							
Switching Frequency in Full Frequency Mode (Average)	f _{OSC}	T _J = 25 °C	FREQUENCY Pin Connected to SOURCE	119	132	145	kHz
			FREQUENCY Pin Connected to CONTROL	59.4	66	72.6	
Frequency Jitter Deviation	Δf		132 kHz Operation		±5		kHz
			66 kHz Operation		±2.5		
Frequency Jitter Modulation Rate	f _M				250		Hz
Maximum Duty Cycle	DC _{MAX}	I _C = I _{CD1}	I _V ≤ I _{V(DC)} V _V = 0 V	75	78	83	%
			I _V = 95 μA	30			
Soft-Start Time	t _{SOFT}		T _J = 25 °C		17		ms
PWM Gain	DC _{REG}		T _J = 25 °C I _B < I _C < I _{CO1} See Note C	-54	-44	-34	%/mA
			T _J = 25 °C I _C ≥ I _{CO1} See Note A	-60	-50	-40	
PWM Gain Temperature Drift			See Note B		-0.01		%/mA/°C
External Bias Current	I _B		66 kHz Operation	0.9	1.5	2.1	mA

Parameter	Symbol	Conditions SOURCE = 0 V; T _J = -40 to 125 °C (Unless Otherwise Specified)	Min	Typ	Max	Units	
Control Functions (cont.)							
External Bias Current	I _B	132 kHz Operation	1.2	1.8	2.4	mA	
CONTROL Current at 0% Duty Cycle	I _{C(OFF)}	66 kHz Operation		3.1	4.1	mA	
		132 kHz Operation		3.4	4.4		
Dynamic Impedance	Z _C	I _C = 2.5 mA; T _J = 25 °C See Figure 22	13	21	25	Ω	
Dynamic Impedance Temperature Drift				0.18		%/°C	
CONTROL Pin Internal Filter Pole				7		kHz	
Upper Peak Current to Set Current Limit Ratio	k _{PS(UPPER)}	T _J = 25 °C See Note C	50	55	60	%	
Lower Peak Current to Set Current Limit Ratio	k _{PS(LOWER)}	T _J = 25 °C See Note C		25		%	
Multi-Cycle-Modulation Switching Frequency	f _{MCM(MIN)}	T _J = 25 °C		30		kHz	
Minimum Multi-Cycle-Modulation On Period	T _{MCM(MIN)}	T _J = 25 °C		135		μs	
Shutdown/Auto-Restart							
CONTROL Pin Charging Current	I _{C(CH)}	T _J = 25 °C	V _C = 0 V	-5.0	-3.5	-1.0	mA
			V _C = 5 V	-3.0	-1.8	-0.6	
Charging Current Temperature Drift		See Note B		0.5		%/°C	
Auto-Restart Upper Threshold Voltage	V _{C(AR)U}			5.8		V	
Auto-Restart Lower Threshold Voltage	V _{C(AR)L}		4.5	4.8	5.1	V	
Voltage Monitor (V) and External Current Limit (X) Inputs							
Auto-Restart Hysteresis Voltage	V _{C(AR)HYST}		0.8	1.0		V	
Auto-Restart Duty Cycle	DC _{AR}			2	4	%	
Auto-Restart Frequency	f _{AR}			0.5		Hz	
Line Undervoltage Threshold Current and Hysteresis (V Pin)	I _{UV}	T _J = 25 °C	Threshold	22	25	27	μA
			Hysteresis		14		μA
Line Overvoltage Threshold Current and Hysteresis (V Pin)	I _{OV}	T _J = 25 °C	Threshold	107	112	117	μA
			Hysteresis		4		μA

Parameter	Symbol	Conditions		Min	Typ	Max	Units
		SOURCE = 0 V; T _J = -40 to 125 °C (Unless Otherwise Specified)					
Voltage Monitor (V) and External Current Limit (X) Inputs (cont.)							
V Pin Remote ON/OFF Voltage	V _{V(TH)}	T _J = 25 °C		0.8	1.0	1.6	V
X Pin Remote-ON/OFF Negative Threshold Current and Hysteresis	I _{REM(N)}	T _J = 25 °C	Threshold	-35	-27	-20	μA
			Hysteresis		5		
V Pin Short-Circuit Current	I _{V(SC)}	T _J = 25 °C	V _V = V _C	300	400	500	μA
X Pin Short-Circuit Current	I _{X(SC)}	V _X = 0 V	Normal Mode	-260	-200	-140	μA
			Auto-Restart Mode	-95	-75	-55	
V Pin Voltage (Positive Current)	V _V	I _V = I _{OV}		2.83	3.0	3.25	V
V Pin Voltage Hysteresis (Positive Current)	V _{V(HYST)}	I _V = I _{OV}		0.2	0.5		V
X Pin Voltage (Negative Current)	V _X	I _X = -50 μA		1.23	1.30	1.37	V
		I _X = -150 μA		1.15	1.22	1.29	
Maximum Duty Cycle Reduction Onset Threshold Current	I _{V(DC)}	I _C ≥ I _B , T _J = 25 °C		18.9	22.0	24.2	μA
Maximum Duty Cycle Reduction Slope		T _J = 25 °C	I _{V(DC)} < I _V < 48 μA		-1.0		% / μA
			I _V ≥ 48 μA		-0.25		
Remote-OFF DRAIN Supply Current	I _{D(RMT)}	V _{DRAIN} = 150 V	X or V Pin Floating		0.6	1.0	mA
			V Pin Shorted to CONTROL		1.0	1.6	
Remote-ON Delay	t _{R(ON)}	From Remote-ON to Drain Turn-On See Note C	66 kHz		3.0		μs
			132 kHz		1.5		
Remote-OFF Set-up Time	t _{R(OFF)}	Minimum Time Before Drain Turn-On to Disable Cycle See Note C	66 kHz		3.0		μs
			132 kHz		1.5		
Frequency Input							
FREQUENCY Pin Threshold Voltage	V _F	See Note B			2.9		V
FREQUENCY Pin Input Current	I _F	T _J = 25 °C	V _F = V _C	10	55	90	μA

Parameter	Symbol	Conditions		Min	Typ	Max	Units
		SOURCE = 0 V; T _J = -40 to 125 °C (Unless Otherwise Specified)					
Circuit Protection							
Self Protection Current Limit (See Note D)	I _{LIMIT}	T _J = 25 °C di/dt = 625 mA/μs		2.800	3.01	3.222	A
Initial Current Limit	I _{INIT}	See Note C		0.70 × I _{LIMIT(MIN)}			A
Power Coefficient	P _{COEFF}	T _J = 25 °C, See Note E	I _X ≤ - 165 μA	0.9 × I _f	I _f	1.2 × I _f	A ² kHz
			I _X ≤ - 117 μA	0.9 × I _f	I _f	1.2 × I _f	
Leading Edge Blanking Time	t _{LEB}	T _J = 25 °C See Figure 23			220		ns
Current Limit Delay	t _{L(D)}				100		ns
Thermal Shutdown Temperature				135	142	150	°C
Thermal Shutdown Hysteresis					75		°C
Power-Up Reset Threshold Voltage	V _{C(RESET)}	Figure 24 (S1 Open Condition)		1.75	3.0	4.25	V
Output							
ON-State Resistance	R _{DS(ON)}	I _D = 400 mA	T _J = 25 °C		2.0	2.30	Ω
			T _J = 100 °C		3.1	3.60	
Drain Supply Voltage		T _J ≤ 85 °C, See Note F		18			V
				36			
OFF-State Drain Leakage Current	I _{DSS}	V _V = Floating, Device Not Switching, V _{DS} = 580 V, T _J = 125 °C				470	μA
Breakdown Voltage	BV _{DSS}	V _V = Floating, Device Not Switching, T _J = 25 °C, See Note G		725			V
Rise Time	t _R	Measured in a Typical Flyback Converter Application			100		ns
Fall Time	t _F				50		ns

Parameter	Symbol	Conditions		Min	Typ	Max	Units
		SOURCE = 0 V; T _J = -40 to 125 °C (Unless Otherwise Specified)					
Supply Voltage Characteristics							
Control Supply/ Discharge Current	I _{CD1}	Output MOSFET Enabled V _X , V _V = 0 V	66 kHz Operation	0.9	1.4	2.3	mA
			132 kHz Operation	1.2	1.7	2.4	
	I _{CD2}	Output MOSFET Disabled V _X , V _V = 0 V	0.3	0.5	1.2		

NOTES:

- A. Derived during test from the parameters DC_{MAX}, I_B and I_{C(OFF)} at 132 kHz.
- B. For specifications with negative values, a negative temperature coefficient corresponds to an increase in magnitude with increasing temperature, and a positive temperature coefficient corresponds to a decrease in magnitude with increasing temperature.
- C. Guaranteed by characterization. Not tested in production.
- D. For externally adjusted current limit values, please refer to Figures 36 and 37 (Current Limit vs. External Current Limit Resistance) in the Typical Performance Characteristics section. The tolerance specified is only valid at full current limit.
- E. I²f calculation is based on typical values of I_{LIMIT} and f_{OSC}, i.e. I_{LIMIT(TYP)}² × f_{OSC}, where f_{OSC} = 66 kHz or 132 kHz depending on FREQUENCY pin connection. See f_{OSC} specification for detail.
- F. The device will start up at 18 V_{DC} drain voltage. The capacitance of electrolytic capacitors drops significantly at temperatures below 0 °C. For reliable start-up at 18 V in sub-zero temperatures, designers must ensure that circuit capacitors meet recommended capacitance values.
- G. Breakdown voltage may be checked against minimum BV_{DSS} specification by ramping the DRAIN pin voltage up to but not exceeding minimum BV_{DSS}.

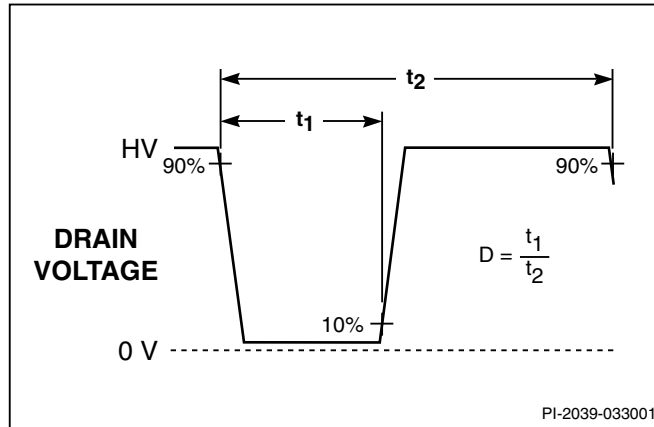

Figure 21. Duty Cycle Measurement.

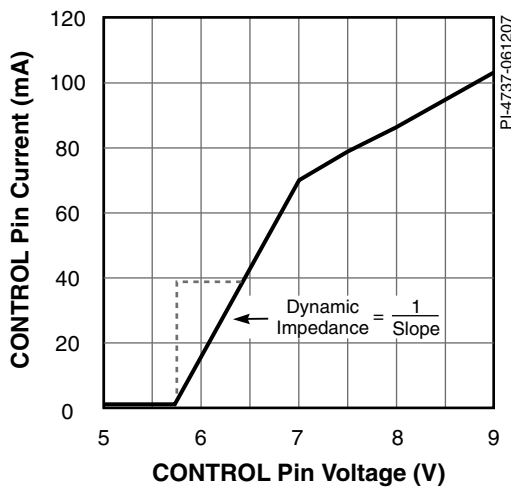

Figure 22. CONTROL Pin I-V Characteristic.

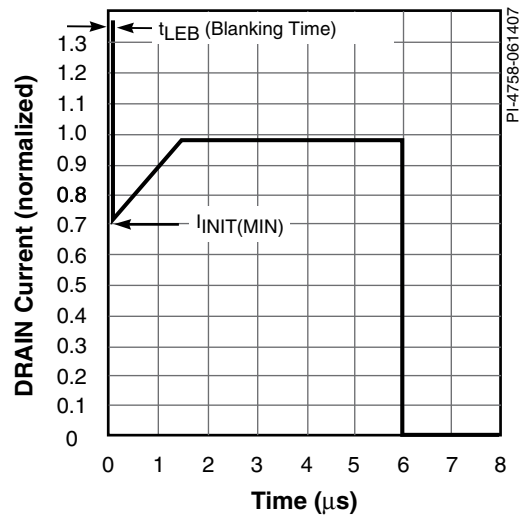

Figure 23. Drain Current Operating Envelope.

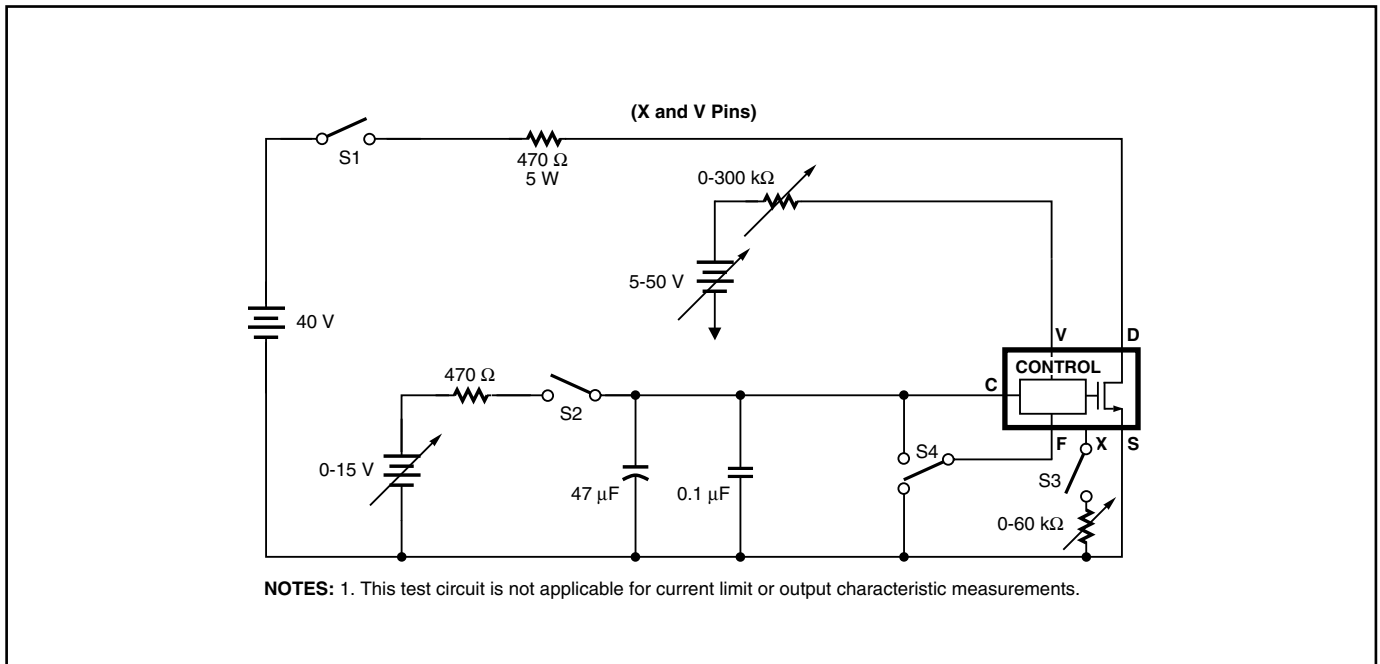

Figure 24. TOPSwitch-JX General Test Circuit.

Typical Performance Characteristics

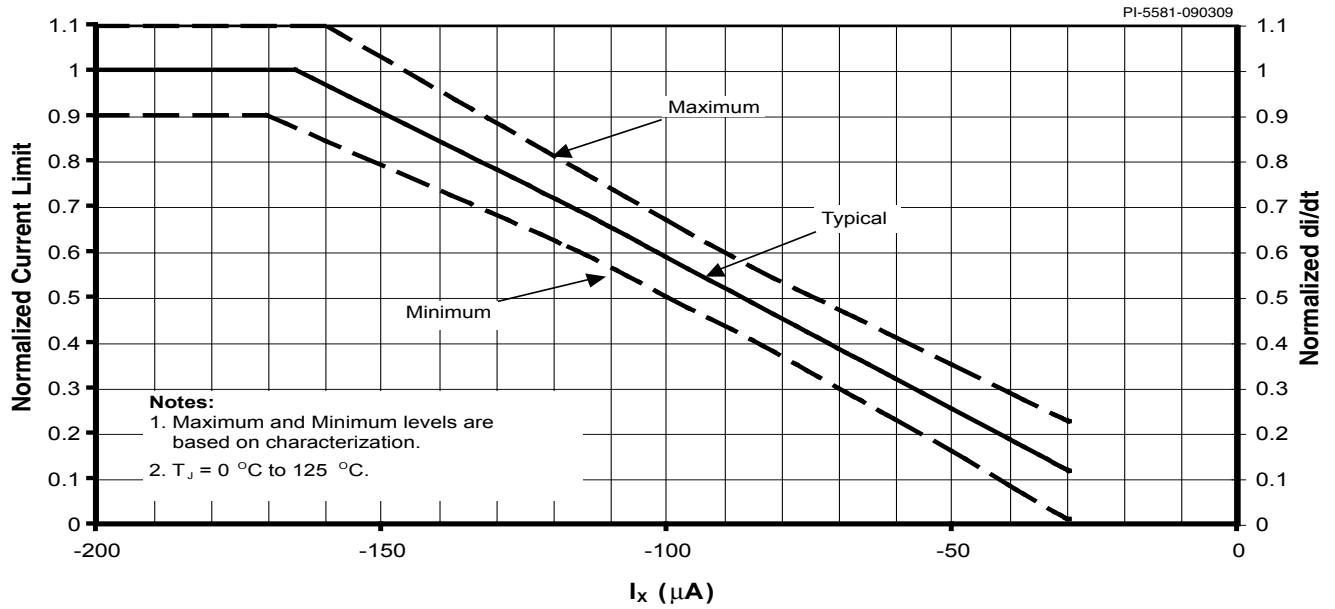

Figure 25. Normalized Current Limit vs. X Pin Current.

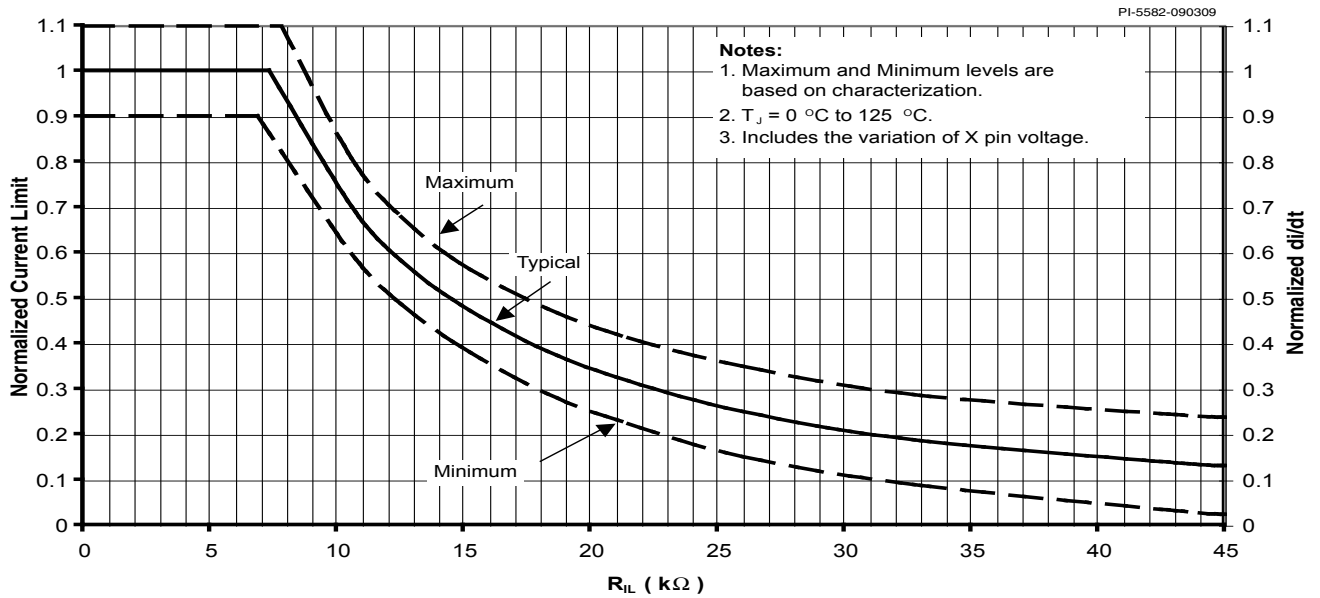

Figure 26. Normalized Current Limit vs. External Current Limit Resistance.

Typical Performance Characteristics (cont.)

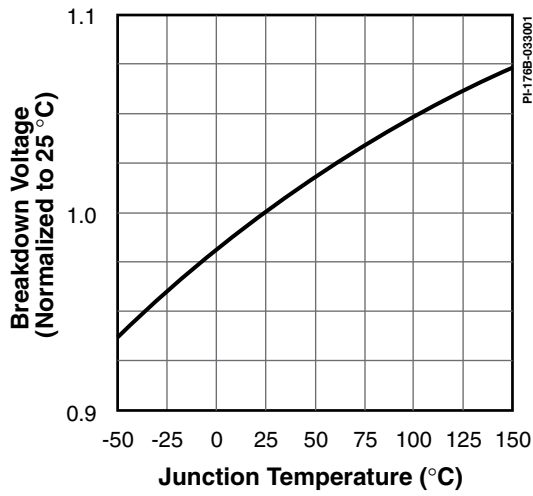

Figure 27. Breakdown Voltage vs. Temperature.

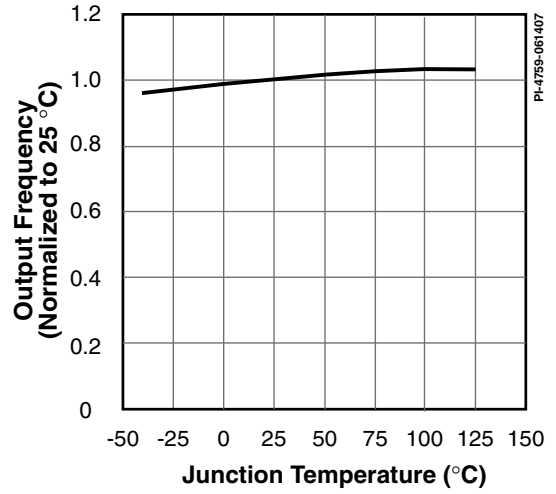

Figure 28. Frequency vs. Temperature.

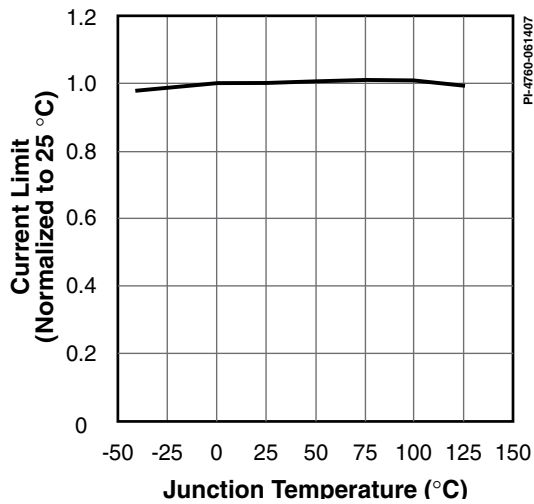

Figure 29. Internal Current Limit vs. Temperature.

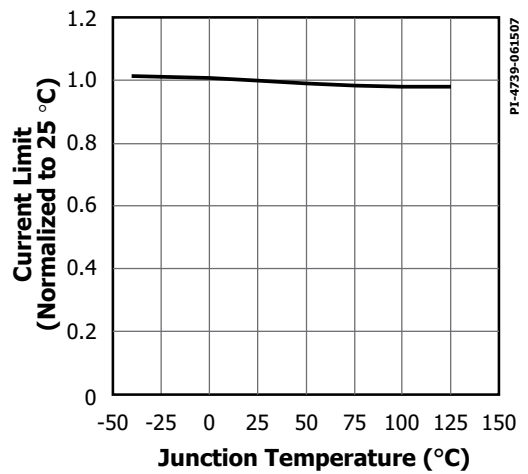

Figure 30. External Current Limit vs. Temperature with $R_L = 10.5 \text{ k}\Omega$.

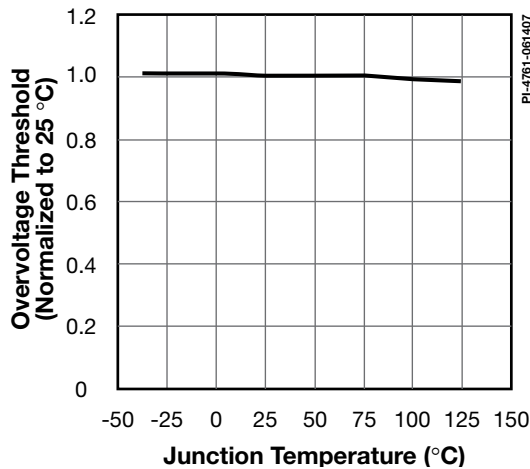

Figure 31. Overvoltage Threshold vs. Temperature.

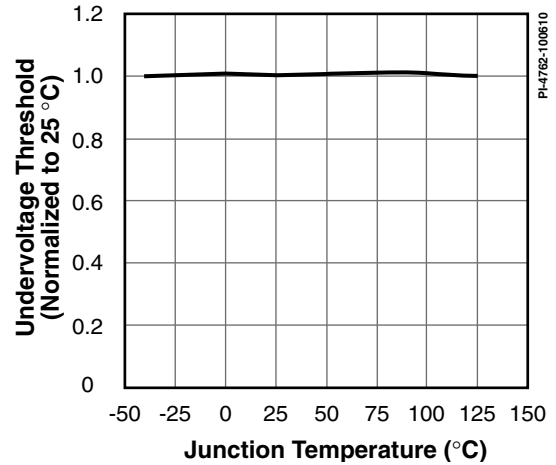

Figure 32. Undervoltage Threshold vs. Temperature.

Typical Performance Characteristics (cont.)

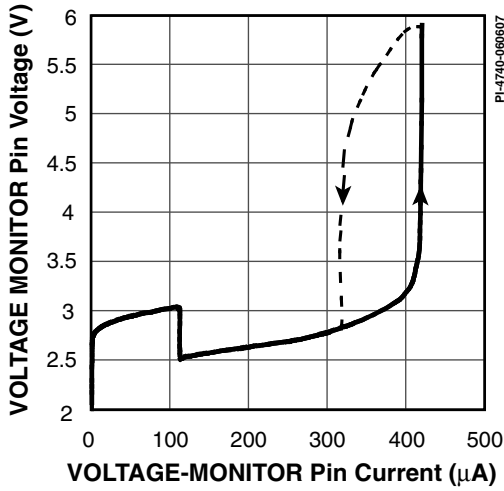

Figure 33. VOLTAGE-MONITOR Pin vs. Current.

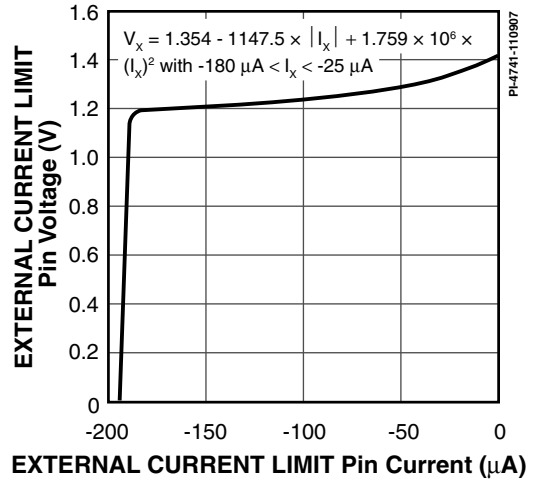

Figure 34. EXTERNAL CURRENT LIMIT Pin Voltage vs. Current.

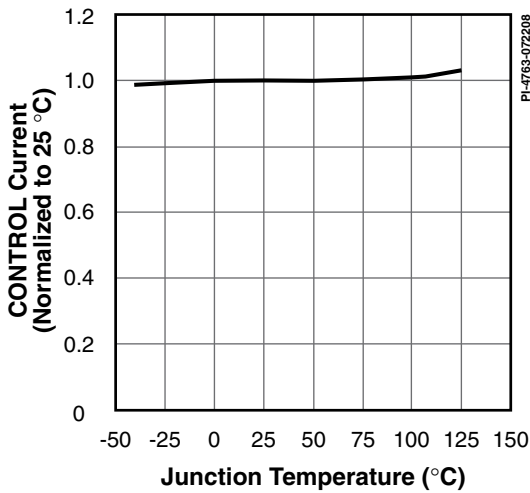

Figure 35. Control Current Out at 0% Duty Cycle vs. Temperature.

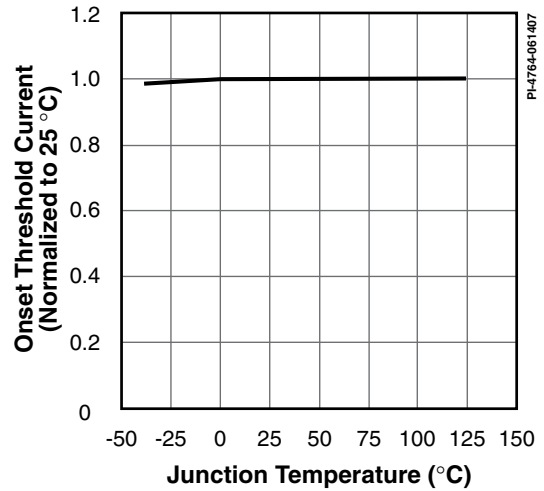

Figure 36. Maximum Duty Cycle Reduction Onset Threshold Current vs. Temperature.

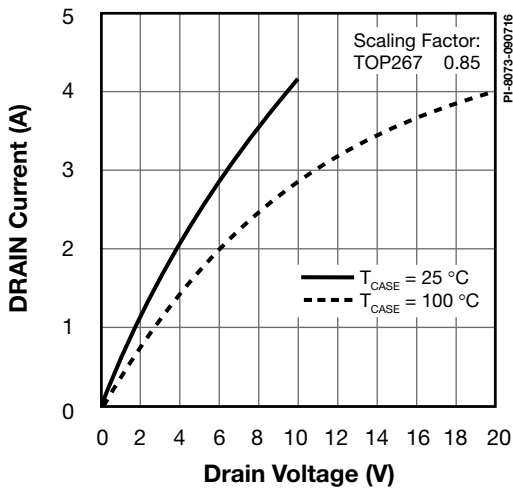

Figure 37. Output Characteristics.

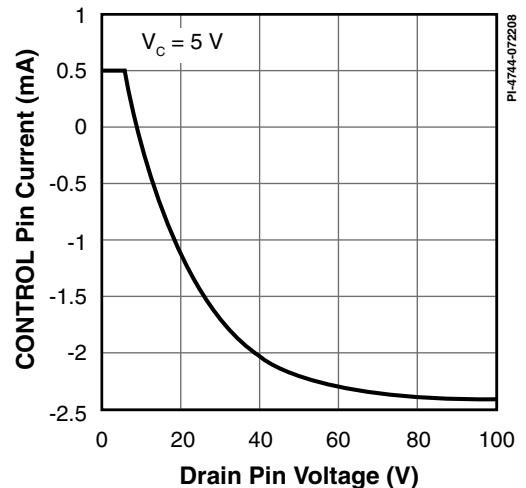

Figure 38. I_c vs. DRAIN Voltage.

Typical Performance Characteristics (cont.)

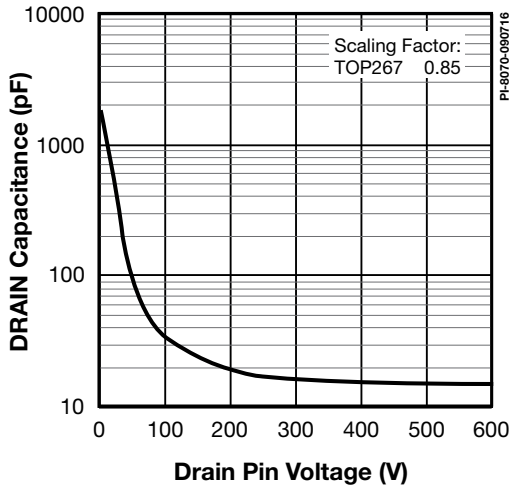

Figure 39. C_{OSS} vs. DRAIN Voltage.

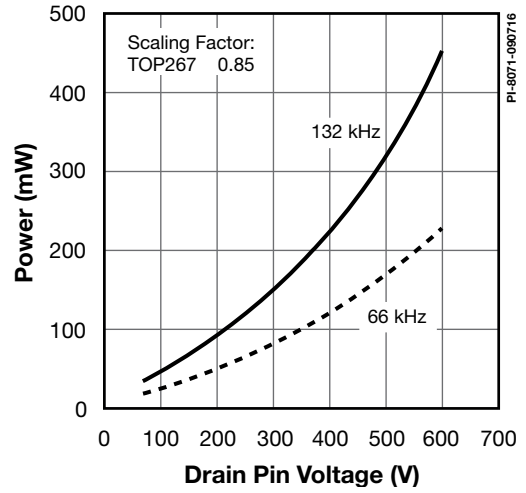

Figure 40. DRAIN Capacitance Power.

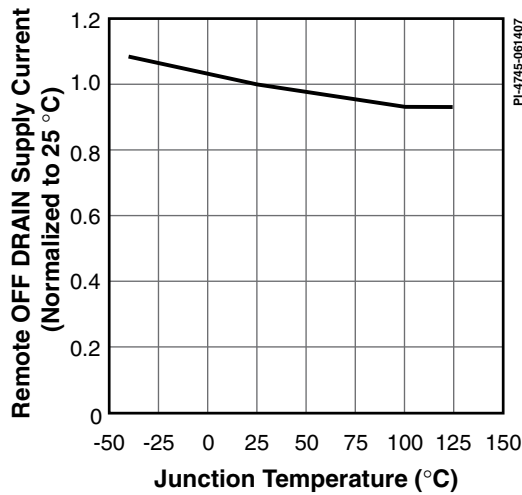
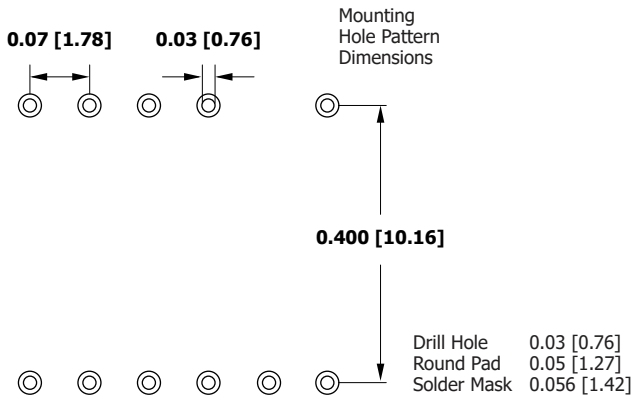
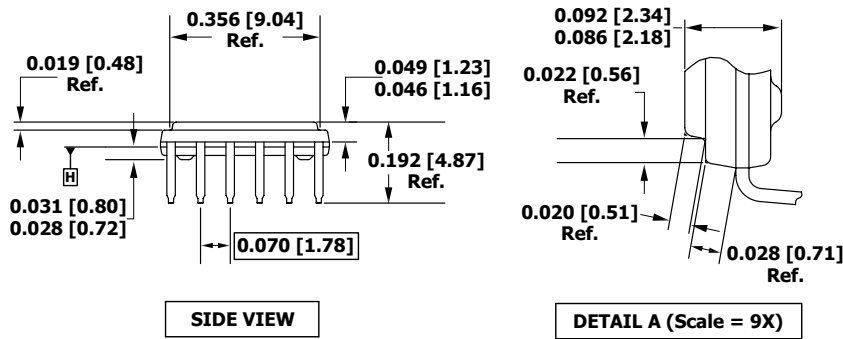
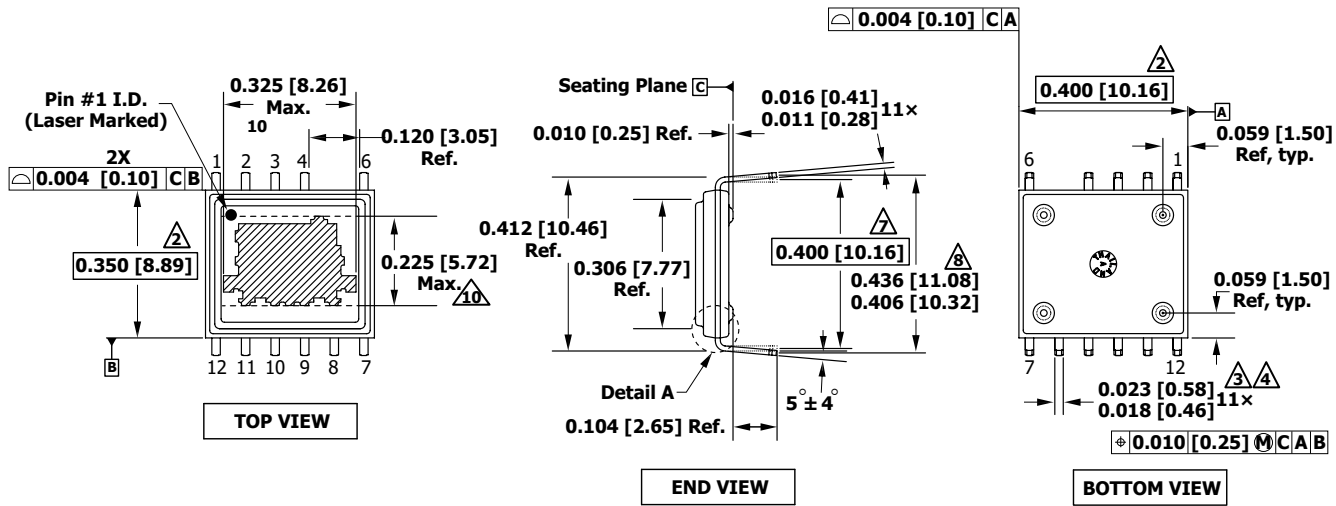

Figure 41. Remote-OFF DRAIN Supply Current vs. Temperature.

eDIP-12B (V Package)



- Notes:**
1. Dimensioning and tolerancing per ASME Y14.5M-1994.
 2. Dimensions noted are determined at the outer-most extremes of the plastic body exclusive of mold flash, tie bar burrs, gate burrs, and interlead flash, but including any mismatch between the top and bottom of the plastic body. Maximum mold protrusion is 0.007 [0.18] per side.
 3. Dimensions noted are inclusive of plating thickness.
 4. Does not include inter-lead flash or protrusions.
 5. Controlling dimensions in inches [mm].
 6. Datums A and B to be determined at Datum H.
 7. Measured with the leads constrained to be perpendicular to Datum C.
 8. Measured with the leads unconstrained.
 9. Lead numbering per JEDEC SPP-012.
 10. Exposed pad is nominally located at the center-line of Datums A and B. "Max" dimensions noted include both size and positional tolerances.

PI-5556b-031820

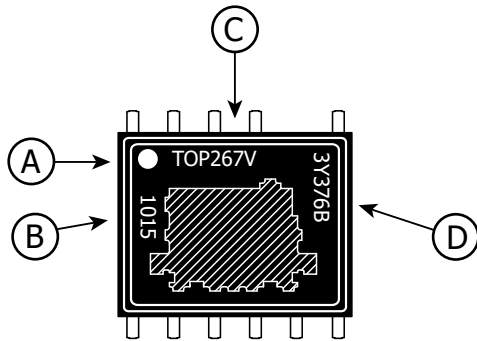
eDIP-12B (V) Plastic Package Marking

- A. Power Integrations Registered Trademark
- B. Assembly Date Code (last two digits of year followed by 2-digit work week)
- C. Product Identification (Part #/Package Type [V = eDIP-12])
- D. Lot Identification Code

PI-5933a-032020

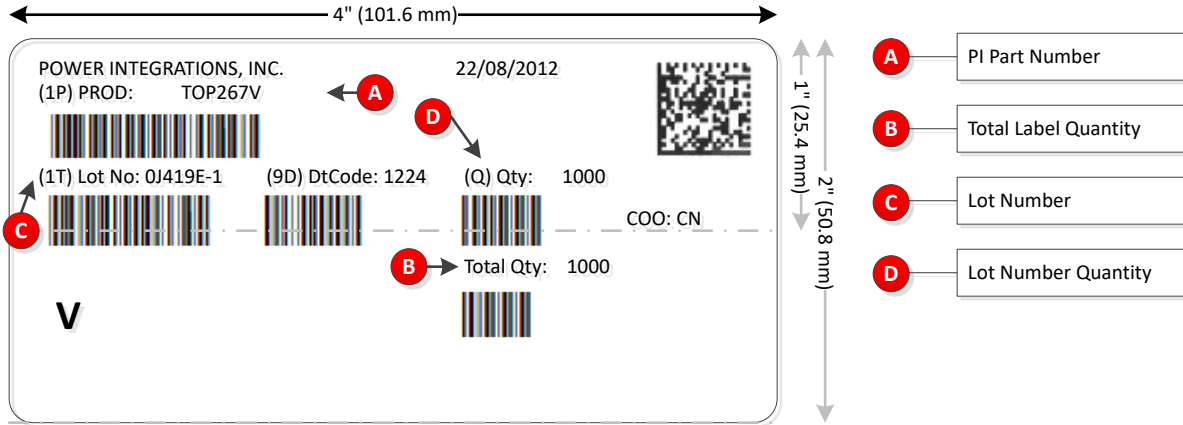

Example Inner Box Label – One Lot.

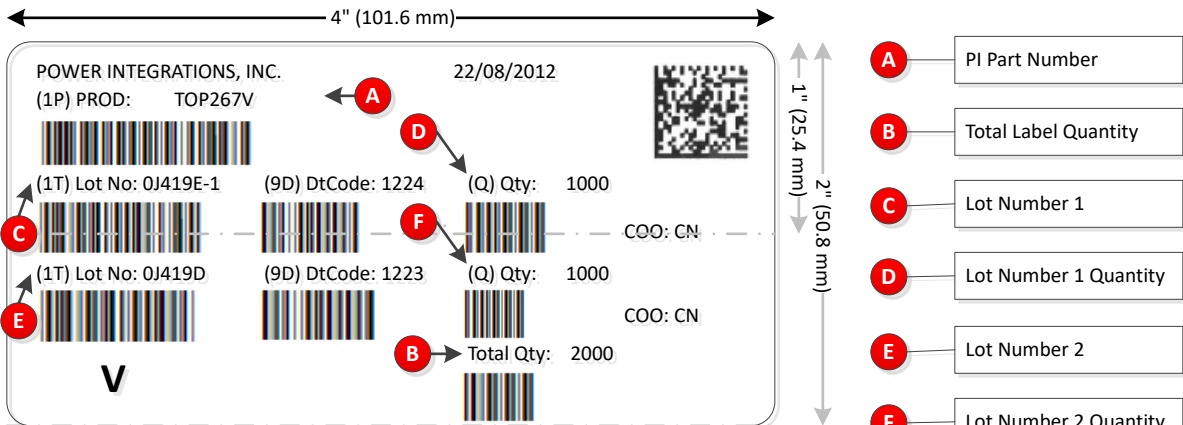

Example Inner Box Label – Two Lots.

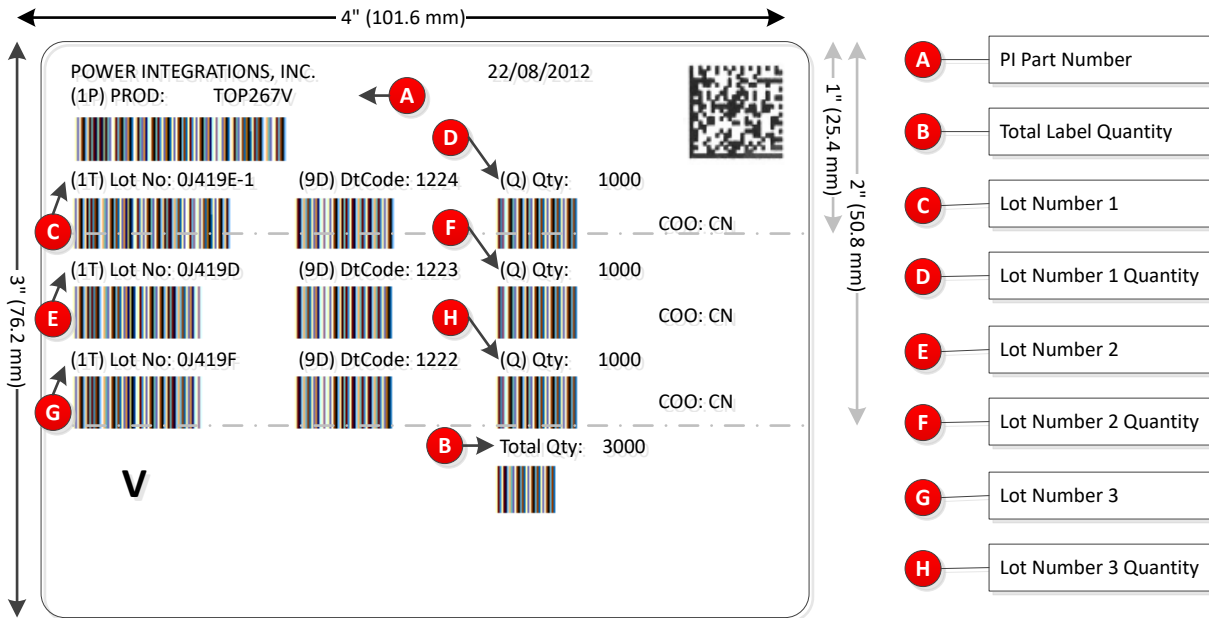

Example Inner Box Label – Three Lots. Note: the 1D and 2D barcodes are for design purposes only.



Example Outer Box Label (not to scale).

Unique IC Information Table

Part Number	Base Part Number	Variation
TOP267V	TOP267VG	Removed latch option

Part Ordering Information



Revision	Notes	Date
A	Data sheet release.	09/16
B	Updated Package Marking and Package drawing.	03/20
C	Removed $I_{OV(AR)}$ parameter on page 8.	12/22

For the latest updates, visit our website: www.power.com

Power Integrations reserves the right to make changes to its products at any time to improve reliability or manufacturability. Power Integrations does not assume any liability arising from the use of any device or circuit described herein. POWER INTEGRATIONS MAKES NO WARRANTY HEREIN AND SPECIFICALLY DISCLAIMS ALL WARRANTIES INCLUDING, WITHOUT LIMITATION, THE IMPLIED WARRANTIES OF MERCHANTABILITY, FITNESS FOR A PARTICULAR PURPOSE, AND NON-INFRINGEMENT OF THIRD PARTY RIGHTS.

Patent Information

The products and applications illustrated herein (including transformer construction and circuits external to the products) may be covered by one or more U.S. and foreign patents, or potentially by pending U.S. and foreign patent applications assigned to Power Integrations. A complete list of Power Integrations patents may be found at www.power.com. Power Integrations grants its customers a license under certain patent rights as set forth at www.power.com/ip.htm.

Life Support Policy

POWER INTEGRATIONS PRODUCTS ARE NOT AUTHORIZED FOR USE AS CRITICAL COMPONENTS IN LIFE SUPPORT DEVICES OR SYSTEMS WITHOUT THE EXPRESS WRITTEN APPROVAL OF THE PRESIDENT OF POWER INTEGRATIONS. As used herein:

A Life support device or system is one which, (i) is intended for surgical implant into the body, or (ii) supports or sustains life, and (iii) whose failure to perform, when properly used in accordance with instructions for use, can be reasonably expected to result in significant injury or death to the user.

A critical component is any component of a life support device or system whose failure to perform can be reasonably expected to cause the failure of the life support device or system, or to affect its safety or effectiveness.

Power Integrations, the Power Integrations logo, CAPZero, ChiPhy, CHY, DPA-Switch, EcoSmart, E-Shield, eSIP, eSOP, HiperLCS, HiperPLC, HiperPFS, HiperTFS, InnoSwitch, Innovation in Power Conversion, InSOP, LinkSwitch, LinkZero, LYTSwitch, SENZero, TinySwitch, TOPSwitch, PI, PI Expert, PowiGaN, SCALE, SCALE-1, SCALE-2, SCALE-3 and SCALE-iDriver, are trademarks of Power Integrations, Inc. Other trademarks are property of their respective companies. ©2022, Power Integrations, Inc.

Power Integrations Worldwide Sales Support Locations

World Headquarters

5245 Hellyer Avenue
San Jose, CA 95138, USA
Main: +1-408-414-9200
Customer Service:
Worldwide: +1-65-635-64480
Americas: +1-408-414-9621
e-mail: usasales@power.com

China (Shanghai)

Rm 2410, Charity Plaza, No. 88
North Caoxi Road
Shanghai, PRC 200030
Phone: +86-21-6354-6323
e-mail: chinasales@power.com

China (Shenzhen)

17/F, Hivac Building, No. 2, Keji Nan
8th Road, Nanshan District,
Shenzhen, China, 518057
Phone: +86-755-8672-8689
e-mail: chinasales@power.com

Germany

(AC-DC/LED/Motor Control Sales)
Einsteinring 24
85609 Dornach/Aschheim
Germany
Tel: +49-89-5527-39100
e-mail: eurosales@power.com

Germany (Gate Driver Sales)

HellwegForum 3
59469 Ense
Germany
Tel: +49-2938-64-39990
e-mail: igbt-driver.sales@power.com

India

#1, 14th Main Road
Vasanthanagar
Bangalore-560052 India
Phone: +91-80-4113-8020
e-mail: indiasales@power.com

Italy

Via Milanese 20, 3rd. Fl.
20099 Sesto San Giovanni (MI) Italy
Phone: +39-024-550-8701
e-mail: eurosales@power.com

Japan

Yusen Shin-Yokohama 1-chome Bldg.
1-7-9, Shin-Yokohama, Kohoku-ku
Yokohama-shi,
Kanagawa 222-0033 Japan
Phone: +81-45-471-1021
e-mail: japansales@power.com

Korea

RM 602, 6FL
Korea City Air Terminal B/D, 159-6
Samsung-Dong, Kangnam-Gu,
Seoul, 135-728, Korea
Phone: +82-2-2016-6610
e-mail: koreasales@power.com

Singapore

51 Newton Road
#19-01/05 Goldhill Plaza
Singapore, 308900
Phone: +65-6358-2160
e-mail: singaporesales@power.com

Taiwan

5F, No. 318, Nei Hu Rd., Sec. 1
Nei Hu Dist.
Taipei 11493, Taiwan R.O.C.
Phone: +886-2-2659-4570
e-mail: taiwansales@power.com

UK

Building 5, Suite 21
The Westbrook Centre
Milton Road
Cambridge
CB4 1YG
Phone: +44 (0) 7823-557484
e-mail: eurosales@power.com

Looking for pricing, stock, or lifecycle information?

Click below to explore more details on WIN SOURCE:

-  [View TOP268KG-TL on WIN SOURCE](#)
-  [Power Integrations](#) Information

Optimize Your Supply Chain with WIN SOURCE Solutions

-  Global Sourcing Solution
-  Obsolete Management
-  Cost Control Management
-  Shortage Management
-  Alternative Solution
-  Excess Inventory Management