

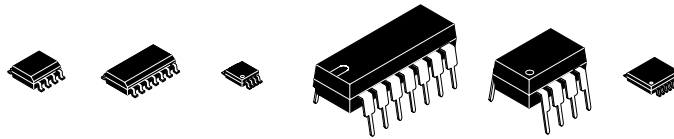

THE DATASHEET OF TLV2702ID





FAMILY OF NANOWATT OPERATIONAL AMPLIFIERS AND PUSH-PULL COMPARATORS

FEATURES

- **Micro-Power Operation . . . 1.4 μ A**
- **Input Common-Mode Range Exceeds the Rails . . . -0.1 V to $V_{CC} + 5$ V**
- **Supply Voltage Range . . . 2.5 V to 16 V**
- **Rail-to-Rail Input/Output (Amplifier)**
- **Reverse Battery Protection Up to 18 V**
- **Gain Bandwidth Product . . . 5.5 kHz (Amplifier)**
- **Push-Pull CMOS Output Stage (Comparator)**
- **Specified Temperature Range**
 - $T_A = -40^\circ\text{C}$ to 125°C . . . Industrial Grade
- **Ultrasmall Packaging**
 - 8-Pin MSOP (TLV2702)
- **Universal Op-Amp EVM (See the SLOU060 For More Information)**

The TLV270x's low supply current is coupled with extremely low input bias currents enabling them to be used with mega-ohm resistors making them ideal for portable, long active life, applications. DC accuracy is ensured with a low typical offset voltage as low as $390\mu\text{V}$, CMRR of 90 dB, and minimum open loop gain of 130 V/mV at 2.7 V.

The maximum recommended supply voltage is as high as 16 V and ensured operation down to 2.5 V, with electrical characteristics specified at 2.7 V, 5 V, and 15 V. The 2.5-V operation makes it compatible with Li-Ion battery-powered systems and many micro-power microcontrollers available today including TI's MSP430.

All members are available in PDIP and SOIC with the duals, one op-amp and one comparator, in the small MSOP package and quads, two operational amplifiers and two comparators, in the TSSOP package.

APPLICATIONS

- **Portable Battery Monitoring**
- **Consumer Medical Electronics**
- **Security Detection Systems**

DESCRIPTION

The TLV270x combines sub-micropower operational amplifier and comparator into a single package that produces excellent micropower signal conditioning with only $1.4\mu\text{A}$ of supply current. This combination gives the designer more board space and reduces part counts in systems that require an operational amplifier and comparator. The low supply current makes it an ideal choice for battery powered portable applications where quiescent current is the primary concern. Reverse battery protection guards the amplifier from an over-current condition due to improper battery installation. For harsh environments, the inputs can be taken 5 V above the positive supply rail without damage to the device.

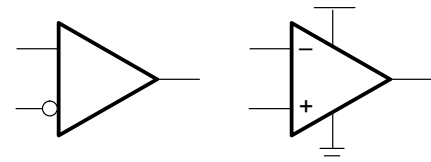

SUPPLY CURRENT
vs
SUPPLY VOLTAGE

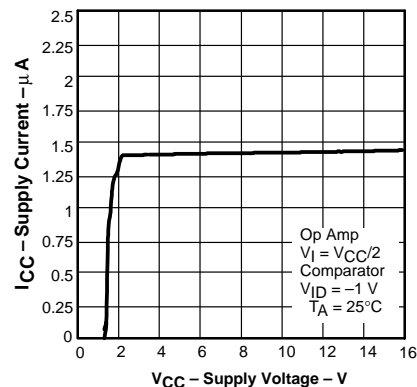

Please be aware that an important notice concerning availability, standard warranty, and use in critical applications of Texas Instruments semiconductor products and disclaimers thereto appears at the end of this data sheet.

A SELECTION OF OUTPUT COMPARATORST

DEVICE	V _{CC} (V)	V _{IO} (μV)	I _{CC} /Ch (μA)	GBW (kHz)	SR (V/μs)	t _{PLH} (μs)	t _{PHL} (μs)	t _f (μs)	RAIL-TO-RAIL	OUTPUT STAGE
TLV270x	2.5 – 16	390	1.4‡	5.5	0.0025	56	83	8	I/O	PP
TLV230x	2.5 – 16	390	1.4‡	5.5	0.0025	55	30	5	I/O	OD
TLV240x	2.5 – 16	390	880	5.5	0.0025	—	—	—	I/O	—
TLV224x	2.5 – 12	600	1	5.5	0.002	—	—	—	I/O	—
TLV340x	2.5 – 16	250	0.47	—	—	55	30	5	I	OD
TLV370x	2.5 – 16	250	0.56	—	—	56	83	8	I	PP

† All specifications are typical values measured at 5 V.

‡ I_{CC} is specified as one op-amp and one comparator.

TLV2702 AVAILABLE OPTIONS

T _A	V _{IO} max AT 25°C	PACKAGED DEVICES			
		SMALL OUTLINE† (D)	MSOP		PLASTIC DIP (P)
			MSOP† (DGK)	SYMBOLS	
-40°C to 125°C	4000 μV	TLV2702ID	TLV2702IDGK	xxTIAQF	TLV2702IP

† This package is available taped and reeled. To order this packaging option, add an R suffix to the part number (e.g., TLV2702IDR).

TLV2704 AVAILABLE OPTIONS

T _A	V _{IO} max AT 25°C	PACKAGED DEVICES		
		SMALL OUTLINE† (D)	TSSOP (PW)	PLASTIC DIP (N)
-40°C to 125°C	4000 μV	TLV2704ID	TLV2704IPW	TLV2704IN

† This package is available taped and reeled. To order this packaging option, add an R suffix to the part number (e.g., TLV2704IDR).

TLV270x PACKAGE PINOUTS

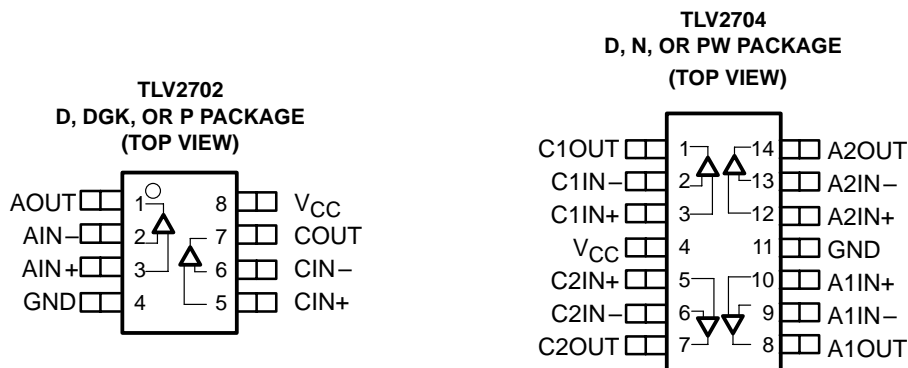

absolute maximum ratings over operating free-air temperature range (unless otherwise noted)†

Supply voltage, V_{CC} (see Note 1)	17 V
Differential input voltage, V_{ID}	V_{CC}
Input voltage range, V_I (see Notes 1 and 2)	0 to $V_{CC} + 5$ V
Input current range, I_I (any input)	± 10 mA
Output current range, I_O	± 10 mA
Continuous total power dissipation	See Dissipation Rating Table
Operating free-air temperature range, T_A : I suffix	-40°C to 125°C
Maximum junction temperature, T_J	150°C
Storage temperature range, T_{stg}	-65°C to 150°C
Lead temperature 1,6 mm (1/16 inch) from case for 10 seconds	260°C

† Stresses beyond those listed under “absolute maximum ratings” may cause permanent damage to the device. These are stress ratings only, and functional operation of the device at these or any other conditions beyond those indicated under “recommended operating conditions” is not implied. Exposure to absolute-maximum-rated conditions for extended periods may affect device reliability.

- NOTES: 1. All voltage values, except differential voltages, are with respect to GND
 2. Input voltage range is limited to 20 V max or $V_{CC} + 5$ V, whichever is smaller.

DISSIPATION RATING TABLE

PACKAGE	θ_{JC} ($^\circ\text{C}/\text{W}$)	θ_{JA} ($^\circ\text{C}/\text{W}$)	$T_A \leq 25^\circ\text{C}$ POWER RATING	$T_A = 125^\circ\text{C}$ POWER RATING
D (8)	38.3	176	710 mW	142 mW
D (14)	26.9	122.3	1022 mW	204.4 mW
DGK (8)	54.2	259.9	481 mW	96.2 mW
N (14)	32	78	1600 mW	320.5 mW
P (8)	41	104	1200 mW	240.4 mW
PW (14)	29.3	173.6	720 mW	144 mW

recommended operating conditions

		MIN	MAX	UNIT
Supply voltage, V_{CC}	Single supply	2.5	16	V
	Split supply	± 1.25	± 8	
Common-mode input voltage range, V_{ICR}	Amplifier and comparator	-0.1	$V_{CC}+5$	V
Operating free-air temperature, T_A		-40	125	$^\circ\text{C}$

electrical characteristics at recommended operating conditions, $V_{CC} = 2.7, 5 \text{ V}$, and 15 V (unless otherwise noted)

amplifier dc performance

PARAMETER		TEST CONDITIONS	T_A^\dagger	MIN	TYP	MAX	UNIT
V_{IO}	Input offset voltage	$V_O = V_{CC}/2 \text{ V}$, $V_{IC} = V_{CC}/2 \text{ V}$, $R_S = 50 \Omega$	25°C	390	4000		μV
			Full range		6000		
αV_{IO}	Offset voltage draft		25°C	3			$\mu\text{V}/^\circ\text{C}$
CMRR	Common-mode rejection ratio	$V_{IC} = 0 \text{ to } V_{CC}$, $R_S = 50 \Omega$	$V_{CC} = 2.7 \text{ V}$	25°C	55	73	dB
				Full range	52		
			$V_{CC} = 5 \text{ V}$	25°C	60	80	
				Full range	55		
			$V_{CC} = 15 \text{ V}$	25°C	66	90	
				Full range	60		
AVD	Large-signal differential voltage amplification	$V_{CC} = 2.7 \text{ V}$, $V_{O(pp)} = 1.5 \text{ V}$, $R_L = 500 \text{ k}\Omega$	25°C	130	400	V/mV	
			Full range	30			
			$V_{CC} = 5 \text{ V}$, $V_{O(pp)} = 3 \text{ V}$, $R_L = 500 \text{ k}\Omega$	25°C	300		1000
				Full range	100		
			$V_{CC} = 15 \text{ V}$, $V_{O(pp)} = 8 \text{ V}$, $R_L = 500 \text{ k}\Omega$	25°C	400		1800
				Full range	120		
PSRR	Power supply rejection ratio ($\Delta V_{CC}/\Delta V_{IO}$)	$V_{IC} = V_{CC}/2 \text{ V}$, No load	$V_{CC} = 2.7 \text{ to } 5 \text{ V}$	25°C	90	120	dB
				Full range	85		
			$V_{CC} = 5 \text{ to } 15 \text{ V}$	25°C	94	120	
				Full range	90		

† Full range is -40°C to 125°C .

amplifier and comparator input characteristics

PARAMETER		TEST CONDITIONS	T_A^\dagger	MIN	TYP	MAX	UNIT
I_{IO}	Input offset current	$V_O = V_{CC}/2 \text{ V}$, $V_{IC} = V_{CC}/2 \text{ V}$ $R_S = 50 \Omega$	25°C		25	250	pA
			0 to 70°C			300	
			Full range			700	
I_{IB}	Input bias current	$V_O = V_{CC}/2 \text{ V}$, $V_{IC} = V_{CC}/2 \text{ V}$ $R_S = 50 \Omega$	25°C		100	500	pA
			0 to 70°C			550	
			Full range			1700	
$r_{i(d)}$	Differential input resistance		25°C		300		$\text{M}\Omega$
$C_{i(c)}$	Common-mode input capacitance	$f = 100 \text{ kHz}$	25°C		3		pF

† Full range is -40°C to 125°C .

electrical characteristics at recommended operating conditions, $V_{CC} = 2.7, 5 \text{ V}$, and 15 V (unless otherwise noted) (continued)

amplifier output characteristics

PARAMETER		TEST CONDITIONS	T_A †	MIN	TYP	MAX	UNIT
V_{OH}	High-level output voltage	$V_{IC} = V_{CC}/2$, $I_{OH} = -50 \mu\text{A}$	25°C	2.55		2.65	V
				Full range	2.5		
			25°C	4.85		4.95	
				Full range	4.8		
			25°C	14.8		14.95	
				Full range	14.8		
V_{OL}	Low-level output voltage	$V_{IC} = V_{CC}/2$, $I_{OL} = 50 \mu\text{A}$	25°C	180	260	mV	
			Full range	300			
I_O	Output current	$V_O = 0.5 \text{ V}$ from rail	25°C	±200		μA	
Z_O	Closed-loop output impedance	$f = 100 \text{ Hz}$, $A_V = 10$	25°C	1.2		kΩ	

† Full range is -40°C to 125°C .

amplifier dynamic performance

PARAMETER		TEST CONDITIONS	T_A	MIN	TYP	MAX	UNIT
UGBW	Unity gain bandwidth	$R_L = 500 \text{ k}\Omega$, $C_L = 100 \text{ pF}$	25°C	5.5		kHz	
SR	Slew rate at unity gain	$V_O(\text{pp}) = 0.8 \text{ V}$, $R_L = 500 \text{ k}\Omega$, $C_L = 100 \text{ pF}$	25°C	2.5		V/ms	
ϕ_M	Phase margin	$R_L = 500 \text{ k}\Omega$, $C_L = 100 \text{ pF}$	25°C	60°			
	Gain margin			15		dB	
t_s	Settling time	$V_{CC} = 2.7 \text{ or } 5 \text{ V}$, $V(\text{STEP})_{PP} = 1 \text{ V}$, $A_V = -1$, $C_L = 100 \text{ pF}$, $R_L = 100 \text{ k}\Omega$	25°C	0.1%		1.84	ms
				0.1%		6.1	
				0.01%		32	
V_n	Equivalent input noise voltage	$f = 0.1 \text{ to } 10 \text{ Hz}$	25°C	5.3		μV_{pp}	
				$f = 100 \text{ Hz}$	500		$\text{nV}/\sqrt{\text{Hz}}$
I_n	Equivalent input noise current	$f = 100 \text{ Hz}$	25°C	8		$\text{fA}/\sqrt{\text{Hz}}$	

supply current

PARAMETER		TEST CONDITIONS	T_A †	MIN	TYP	MAX	UNIT	
I_{CC}	Supply current (one op-amp and one comparator)	$V_O = V_{CC}/2$	25°C	$V_{CC} = 2.7 \text{ V or } 5 \text{ V}$		1.4	μA	
				25°C	$V_{CC} = 15 \text{ V}$			1.4
			Full range			3.7		
Reverse supply current		$V_{CC} = -18 \text{ V}$, $V_I = 0 \text{ V}$, $V_O = \text{open}$	25°C	50		nA		

† Full range is -40°C to 125°C .

electrical characteristics at recommended operating conditions, $V_{CC} = 2.7, 5 \text{ V}$, and 15 V (unless otherwise noted) (continued)

comparator dc performance

PARAMETER		TEST CONDITIONS†		T_A †	MIN	TYP	MAX	UNIT
V_{IO}	Input offset voltage	$V_{IC} = V_{CC}/2, R_S = 50 \Omega$		25°C	250	5000		μV
				Full range		7000		
α_{VIO}	Offset voltage drift			25°C		3		$\mu\text{V}/^\circ\text{C}$
CMRR	Common-mode rejection ratio	$V_{IC} = 0 \text{ to } V_{CC}, R_S = 50 \Omega$	$V_{CC} = 2.7 \text{ V}$	25°C	55	72		dB
				Full range		50		
			$V_{CC} = 5 \text{ V}$	25°C	60	76		
				Full range		55		
			$V_{CC} = 15 \text{ V}$	25°C	65	88		
				Full range		60		
A_{VD}	Large-signal differential voltage amplification			25°C		1000		V/mV
PSRR	Power supply rejection ratio ($\Delta V_{CC}/\Delta V_{IO}$)	$V_{IC} = V_{CC}/2 \text{ V}$, No load	$V_{CC} = 2.7 \text{ to } 5 \text{ V}$	25°C	75	100		dB
				Full range		70		
			$V_{CC} = 5 \text{ to } 15 \text{ V}$	25°C	85	105		
				Full range		80		

† Full range is -40°C to 125°C .

comparator output characteristics

PARAMETER		TEST CONDITIONS†		T_A †	MIN	TYP	MAX	UNIT
$r_{i(d)}$	Differential input resistance			25°C		300		$\text{M}\Omega$
V_{OH}	High-level output voltage	$V_{IC} = V_{CC}/2, V_{ID} = 1 \text{ V}$	$I_{OL} = -50 \mu\text{A}$	25°C	$V_{CC}-320$			mV
				Full range	$V_{CC}-450$			
V_{OL}	Low-level output voltage	$V_{IC} = V_{CC}/2, V_{ID} = -1 \text{ V}$	$I_{OL} = 50 \mu\text{A}$	25°C		80	200	mV
				Full range			300	

† Full range is -40°C to 125°C .

switching characteristics at recommended operating conditions, $V_{CC} = 2.7 \text{ V}, 5 \text{ V}, 15 \text{ V}$ (unless otherwise noted)

PARAMETER		TEST CONDITIONS		T_A	MIN	TYP	MAX	UNIT
$t_{(PLH)}$	Propagation response time, low-to-high-level output	$f = 10 \text{ kHz}, V_{STEP} = 100 \text{ mV}, C_L = 10 \text{ pF}, V_{CC} = 2.7 \text{ V}$	Overdrive = 2 mV	25°C	240		μs	
					Overdrive = 10 mV	64		
						Overdrive = 50 mV		36
Overdrive = 2 mV	167							
	Overdrive = 10 mV		67					
			Overdrive = 50 mV	37				
$t_{(PHL)}$		Propagation response time, high-to-low-level output				25°C		
t_r	Rise time	$C_L = 10 \text{ pF}, V_{CC} = 2.7 \text{ V}$		25°C		7		μs
t_f	Fall time	$C_L = 10 \text{ pF}, V_{CC} = 2.7 \text{ V}$	25°C		9		μs	

NOTE: The propagation response time specified is the interval between the input step function and the instant when the output crosses 1.4 V. Propagation responses are longer at higher supply voltages, refer to Figure 18 through Figure 36 for further details.

TYPICAL CHARACTERISTICS

Table of Graphs

			FIGURE
V_{IO}	Input offset voltage	vs Common-mode input voltage	1, 2
I_{IB}	Input bias current	vs Free-air temperature	3, 5, 7
		vs Common-mode input voltage	4, 6
I_{IO}	Input offset current	vs Free-air temperature	3, 5, 7
		vs Common-mode input voltage	4, 6
I_{CC}	Supply current	vs Supply voltage	8
		vs Free-air temperature	9
Amplifier			
CMRR	Common-mode rejection ratio	vs Frequency	10
V_{OH}	High-level output voltage	vs High-level output current	11, 13
V_{OL}	Low-level output voltage	vs Low-level output current	12, 14
$V_{O(PP)}$	Output voltage, peak-to-peak	vs Frequency	15
PSRR	Power supply rejection ratio	vs Frequency	16
	Voltage noise over a 10 Second Period		17
ϕ_m	Phase margin	vs Capacitive load	18
A_{VD}	Differential voltage gain	vs Frequency	19
	Phase	vs Frequency	19
	Gain-bandwidth product	vs Supply voltage	20
SR	Slew rate	vs Free-air temperature	21
	Large-signal follower pulse response		22
	Small-signal follower pulse response		23
	Large-signal inverting pulse response		24
	Small-signal inverting pulse response		25
Comparator			
V_{OH}	High-level output voltage	vs High-level output current	26, 28
V_{OL}	Low-level output voltage	vs Low-level output current	27, 29
	Output rise/fall time	vs Supply voltage	30
	Low-to-high level output response for various input overdrives		31, 33, 35
	High-to-low level output response for various input overdrives		32, 34, 36

AMPLIFIER AND COMPARATOR TYPICAL CHARACTERISTICS

INPUT OFFSET VOLTAGE
vs
COMMON-MODE INPUT VOLTAGE

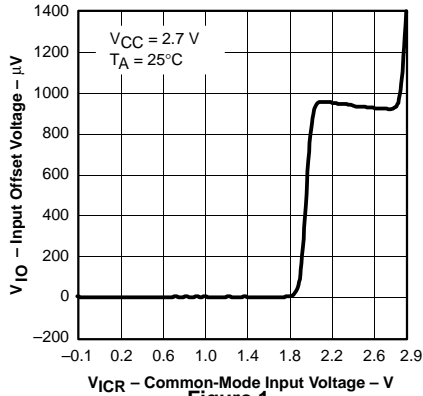

Figure 1

INPUT OFFSET VOLTAGE
vs
COMMON-MODE INPUT VOLTAGE

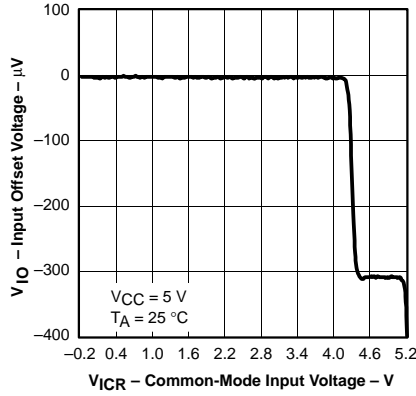

Figure 2

INPUT BIAS / OFFSET CURRENT
vs
FREE-AIR TEMPERATURE

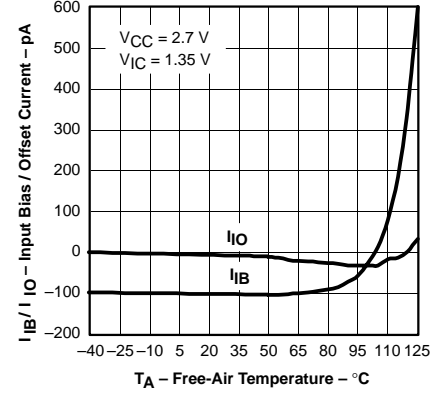

Figure 3

INPUT BIAS/OFFSET CURRENT
vs
COMMON MODE INPUT
VOLTAGE

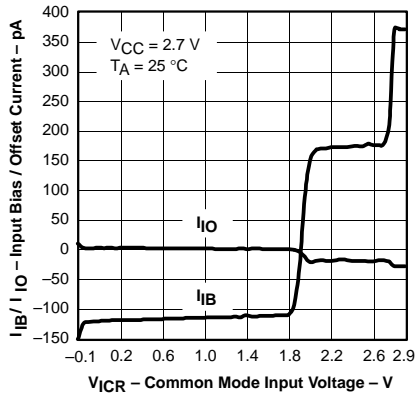

Figure 4

INPUT BIAS/OFFSET CURRENT
vs
FREE-AIR TEMPERATURE

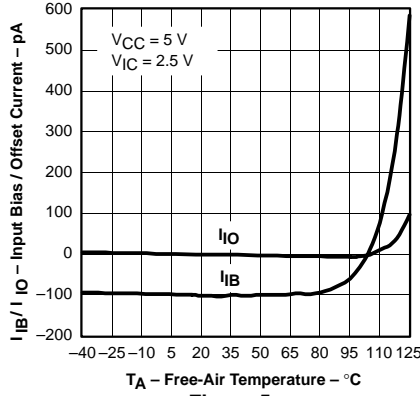

Figure 5

INPUT BIAS/OFFSET CURRENT
vs
COMMON-MODE INPUT
VOLTAGE

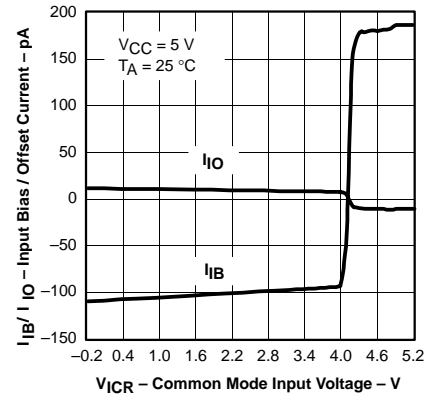

Figure 6

INPUT BIAS/OFFSET CURRENT
vs
FREE-AIR TEMPERATURE

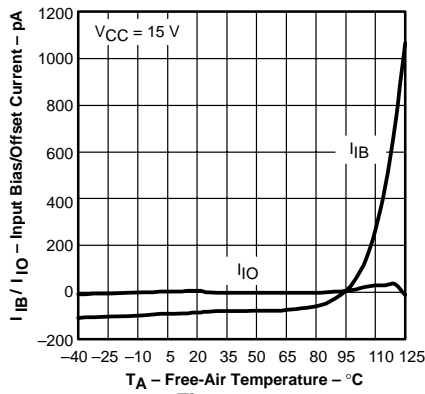

Figure 7

SUPPLY CURRENT
vs
SUPPLY VOLTAGE

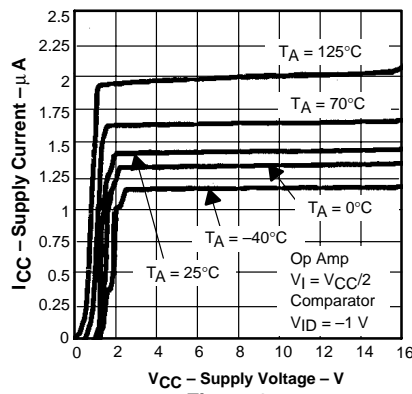

Figure 8

SUPPLY CURRENT
vs
FREE-AIR TEMPERATURE

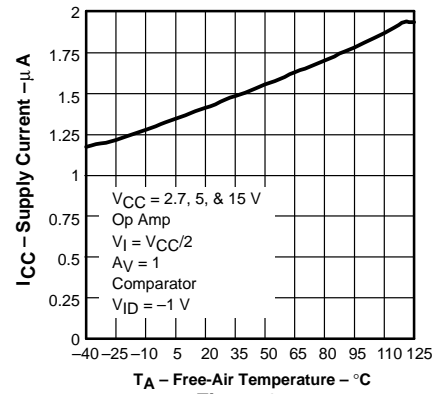

Figure 9

AMPLIFIER TYPICAL CHARACTERISTICS

COMMON-MODE REJECTION RATIO
vs
FREQUENCY

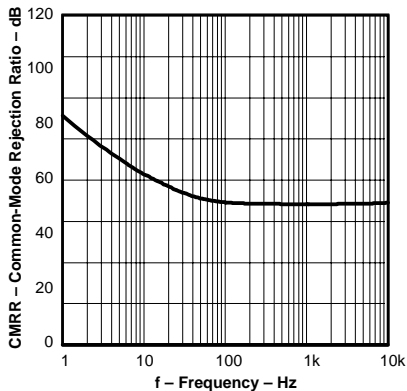

Figure 10

HIGH-LEVEL OUTPUT VOLTAGE
vs
HIGH-LEVEL OUTPUT CURRENT

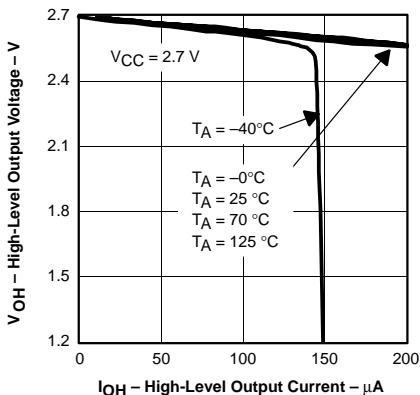

Figure 11

LOW-LEVEL OUTPUT VOLTAGE
vs
LOW-LEVEL OUTPUT CURRENT

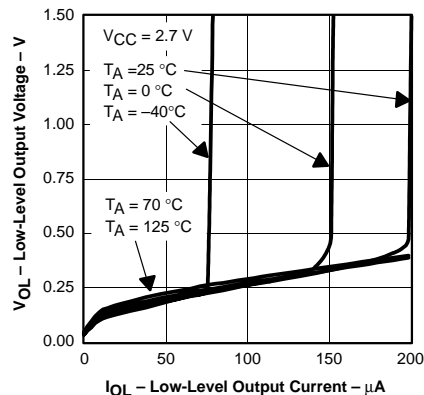

Figure 12

HIGH-LEVEL OUTPUT VOLTAGE
vs
HIGH-LEVEL OUTPUT CURRENT

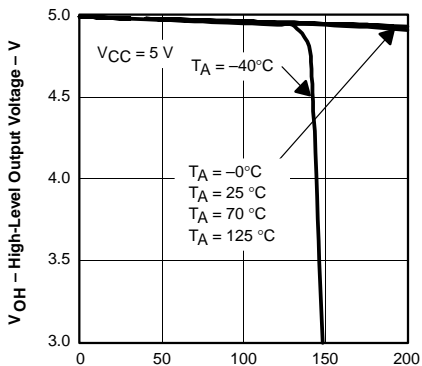

Figure 13

LOW-LEVEL OUTPUT VOLTAGE
vs
LOW-LEVEL OUTPUT CURRENT

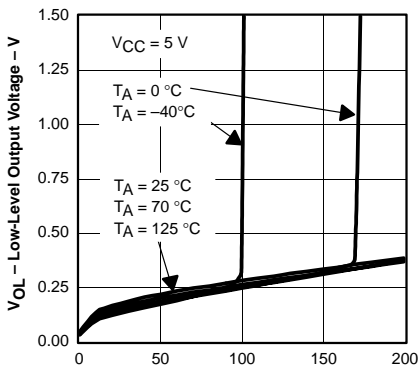

Figure 14

OUTPUT VOLTAGE
PEAK-TO-PEAK
vs
FREQUENCY

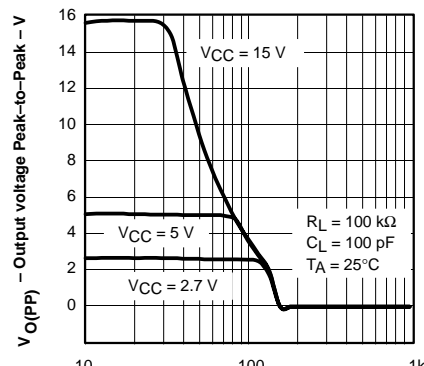

Figure 15

POWER SUPPLY REJECTION RATIO
vs
FREQUENCY

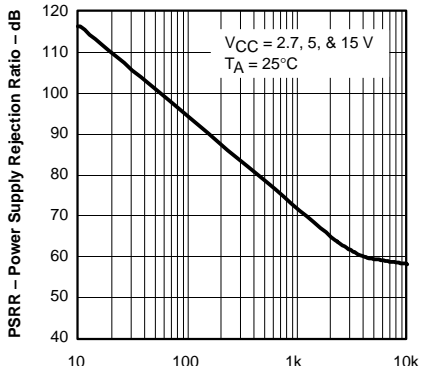

Figure 16

VOLTAGE NOISE
OVER A 10 SECOND PERIOD

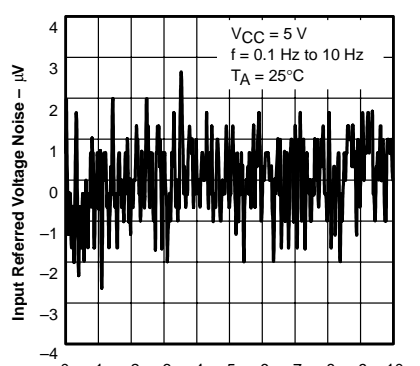

Figure 17

PHASE MARGIN
vs
CAPACITIVE LOAD

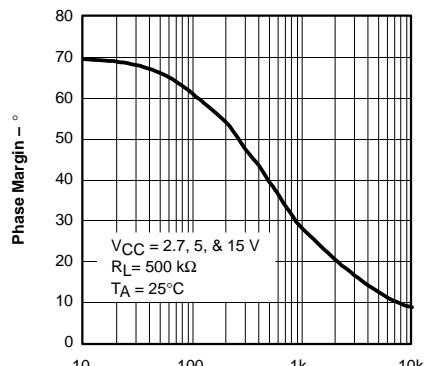

Figure 18

AMPLIFIER TYPICAL CHARACTERISTICS

DIFFERENTIAL VOLTAGE GAIN AND PHASE
vs
FREQUENCY

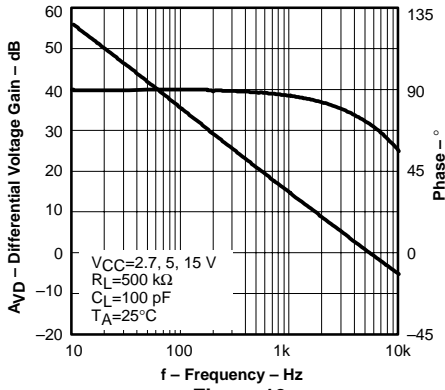

Figure 19

GAIN BANDWIDTH PRODUCT
vs
SUPPLY VOLTAGE

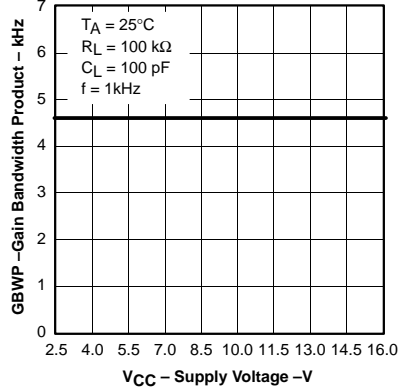

Figure 20

SLEW RATE
vs
FREE-AIR TEMPERATURE

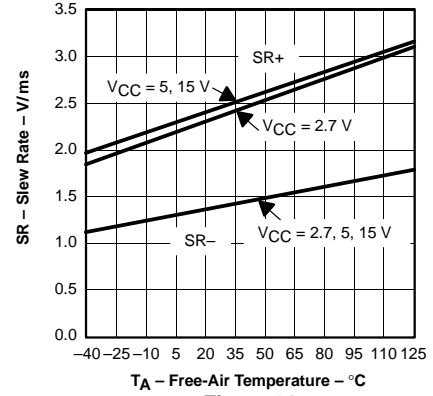

Figure 21

LARGE-SIGNAL FOLLOWER
PULSE RESPONSE

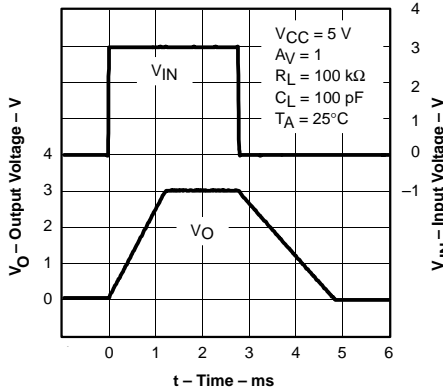

Figure 22

SMALL-SIGNAL FOLLOWER
PULSE RESPONSE

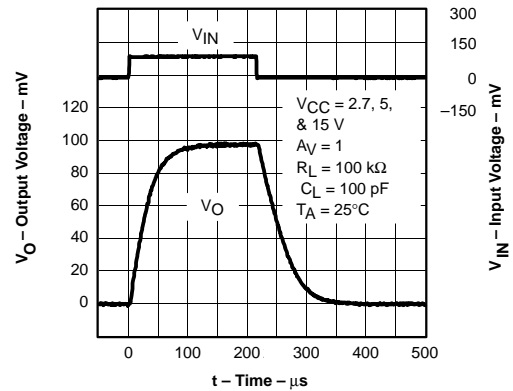

Figure 23

LARGE-SIGNAL INVERTING
PULSE RESPONSE

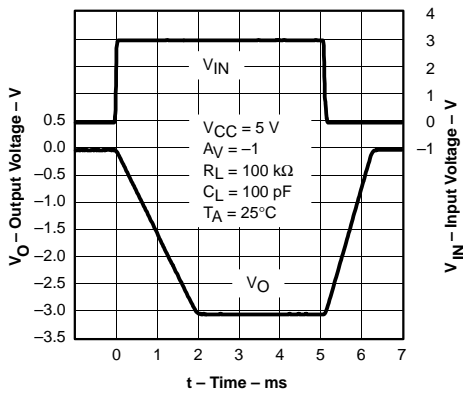

Figure 24

SMALL-SIGNAL INVERTING
PULSE RESPONSE

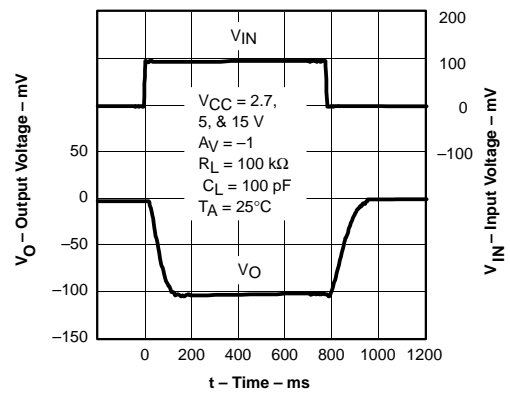
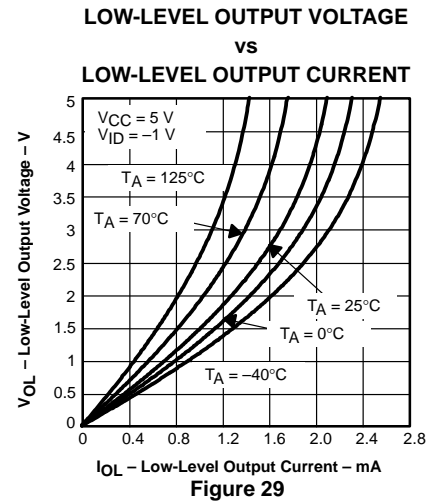
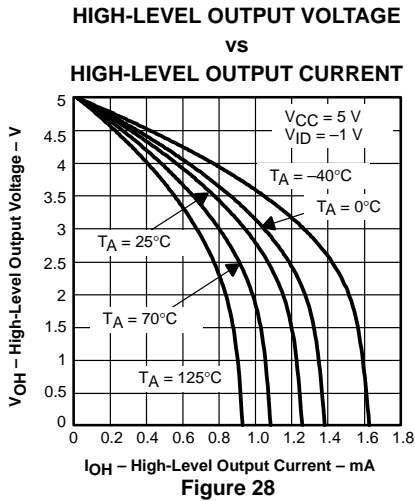
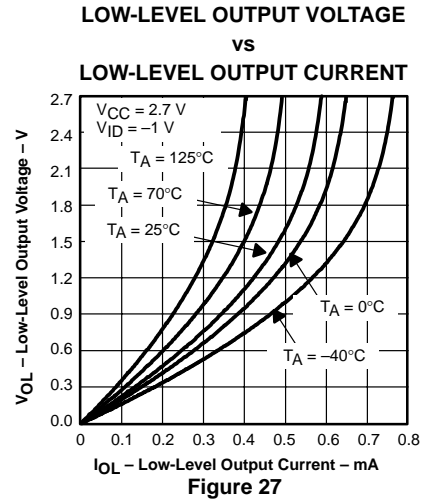
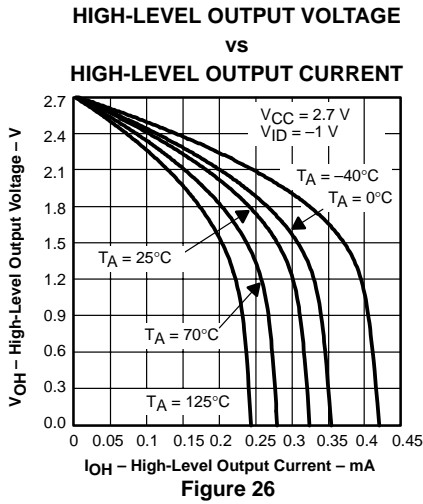
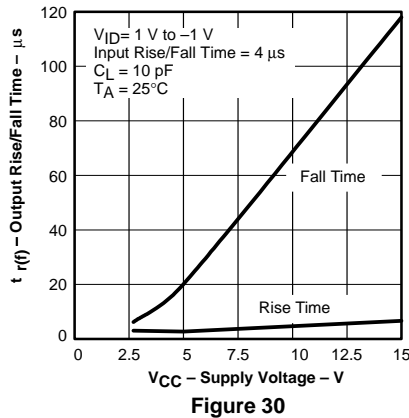

Figure 25

COMPARATOR TYPICAL CHARACTERISTICS



OUTPUT RISE/FALL TIME vs SUPPLY VOLTAGE



TYPICAL CHARACTERISTICS

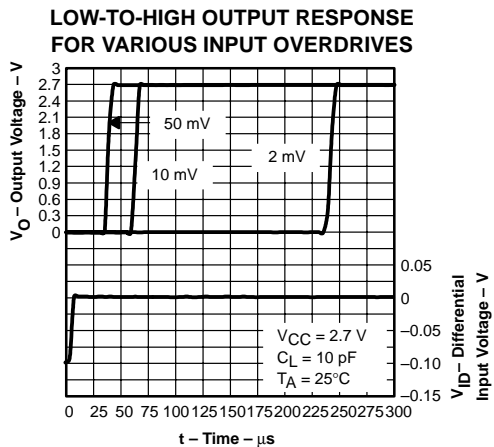

Figure 31

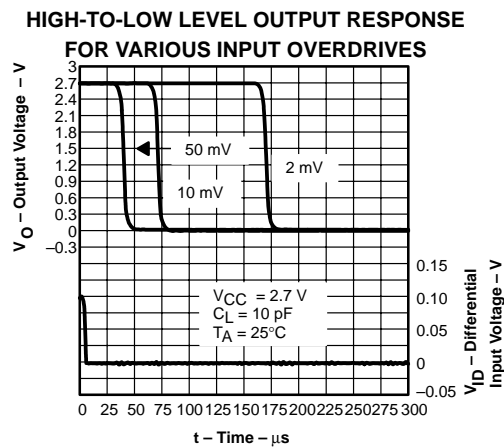

Figure 32

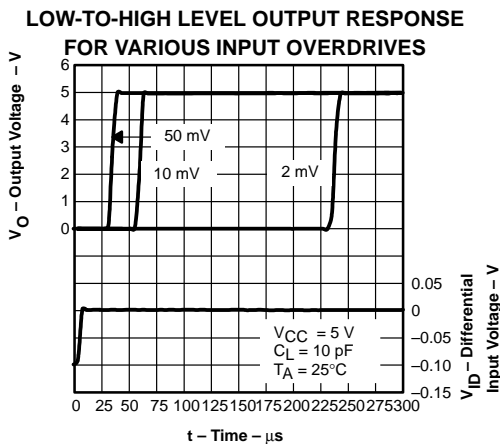

Figure 33

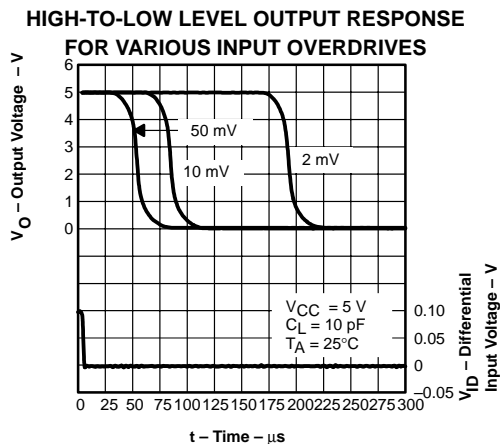

Figure 34

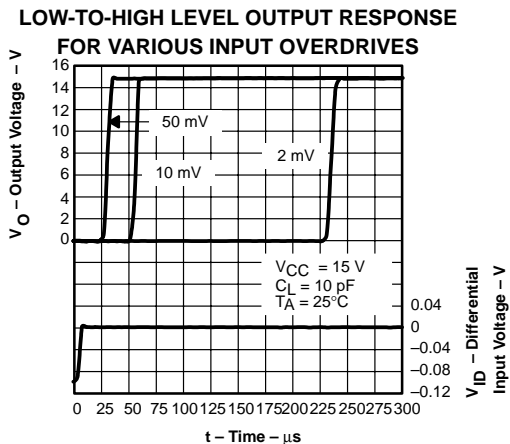

Figure 35

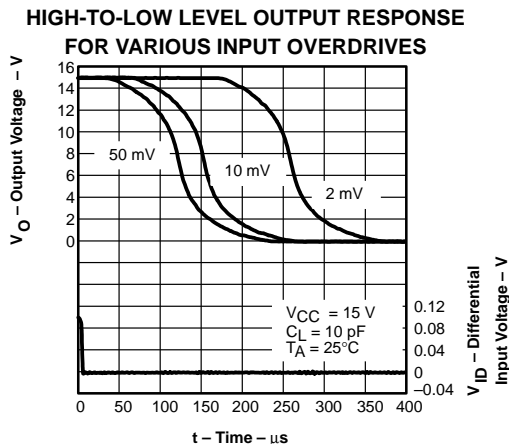

Figure 36

APPLICATION INFORMATION

reverse battery protection

The TLV2702/4 are protected against reverse battery voltage up to 18 V. When subjected to reverse battery condition the supply current is typically less than 100 nA at 25°C (inputs grounded and outputs open). This current is determined by the leakage of 6 Schottky diodes and will therefore increase as the ambient temperature increases.

When subjected to reverse battery conditions and negative voltages applied to the inputs or outputs, the input ESD structure will turn on—this current should be limited to less than 10 mA. If the inputs or outputs are referred to ground, rather than midrail, no extra precautions need be taken.

common-mode input range

The TLV2702/4 has rail-rail input and outputs. For common-mode inputs from -0.1 V to $V_{CC} - 0.8$ V a PNP differential pair will provide the gain.

For inputs between $V_{CC} - 0.8$ V and V_{CC} , two NPN emitter followers buffering a second PNP differential pair provide the gain. This special combination of NPN/PNP differential pair enables the inputs to be taken 5 V above the rails; because as the inputs go above V_{CC} , the NPNs switch from functioning as transistors to functioning as diodes. This will lead to an increase in input bias current. The second PNP differential pair continues to function normally as the inputs exceed V_{CC} .

The TLV2702/4 has a negative common-input range that exceeds ground by 100 mV. If the inputs are taken much below this, reduced open loop gain will be observed with the ultimate possibility of phase inversion.

offset voltage

The output offset voltage, (V_{OO}) is the sum of the input offset voltage (V_{IO}) and both input bias currents (I_{IB}) times the corresponding gains. The following schematic and formula can be used to calculate the output offset voltage.

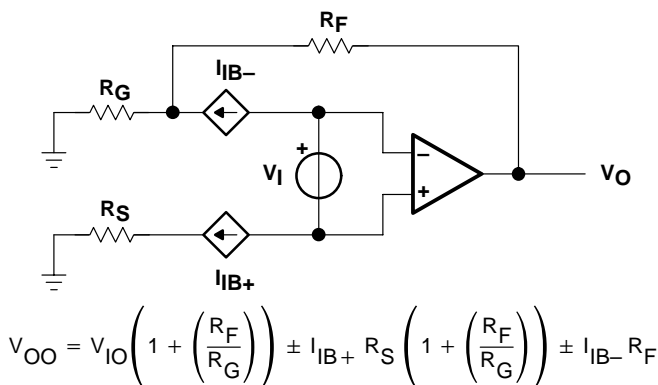

Figure 37. Output Offset Voltage Model

APPLICATION INFORMATION

general configurations

When receiving low-level signals, limiting the bandwidth of the incoming signals into the system is often required. The simplest way to accomplish this is to place an RC filter at the noninverting terminal of the amplifier (see Figure 38).

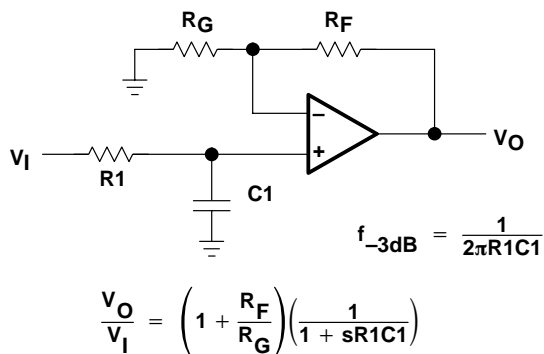

Figure 38. Single-Pole Low-Pass Filter

If even more attenuation is needed, a multiple pole filter is required. The Sallen-Key filter can be used for this task. For best results, the amplifier should have a bandwidth that is 8 to 10 times the filter frequency bandwidth. Failure to do this can result in phase shift of the amplifier.

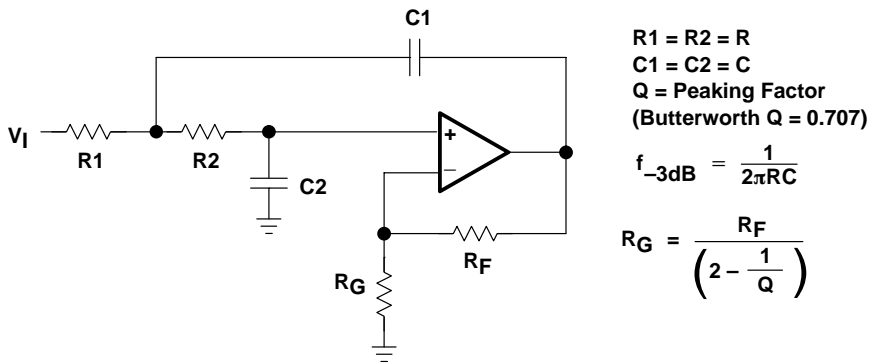

Figure 39. 2-Pole Low-Pass Sallen-Key Filter

APPLICATION INFORMATION

circuit layout considerations

To achieve the levels of high performance of the TLV270x, follow proper printed-circuit board design techniques. A general set of guidelines is given in the following.

- Ground planes—It is highly recommended that a ground plane be used on the board to provide all components with a low inductive ground connection. However, in the areas of the amplifier inputs and output, the ground plane can be removed to minimize the stray capacitance.
- Proper power supply decoupling—Use a 6.8- μ F tantalum capacitor in parallel with a 0.1- μ F ceramic capacitor on each supply terminal. It may be possible to share the tantalum among several amplifiers depending on the application, but a 0.1- μ F ceramic capacitor should always be used on the supply terminal of every amplifier. In addition, the 0.1- μ F capacitor should be placed as close as possible to the supply terminal. As this distance increases, the inductance in the connecting trace makes the capacitor less effective. The designer should strive for distances of less than 0.1 inches between the device power terminals and the ceramic capacitors.
- Sockets—Sockets can be used but are not recommended. The additional lead inductance in the socket pins will often lead to stability problems. Surface-mount packages soldered directly to the printed-circuit board is the best implementation.
- Short trace runs/compact part placements—Optimum high performance is achieved when stray series inductance has been minimized. To realize this, the circuit layout should be made as compact as possible, thereby minimizing the length of all trace runs. Particular attention should be paid to the inverting input of the amplifier. Its length should be kept as short as possible. This will help to minimize stray capacitance at the input of the amplifier.
- Surface-mount passive components—Using surface-mount passive components is recommended for high performance amplifier circuits for several reasons. First, because of the extremely low lead inductance of surface-mount components, the problem with stray series inductance is greatly reduced. Second, the small size of surface-mount components naturally leads to a more compact layout thereby minimizing both stray inductance and capacitance. If leaded components are used, it is recommended that the lead lengths be kept as short as possible.

general power dissipation considerations

For a given θ_{JA} , the maximum power dissipation is shown in Figure 40 and is calculated by the following formula:

$$P_D = \left(\frac{T_{MAX} - T_A}{\theta_{JA}} \right)$$

Where:

- P_D = Maximum power dissipation of TLV270x IC (watts)
- T_{MAX} = Absolute maximum junction temperature (150°C)
- T_A = Free-ambient air temperature (°C)
- θ_{JA} = $\theta_{JC} + \theta_{CA}$
- θ_{JC} = Thermal coefficient from junction to case
- θ_{CA} = Thermal coefficient from case to ambient air (°C/W)

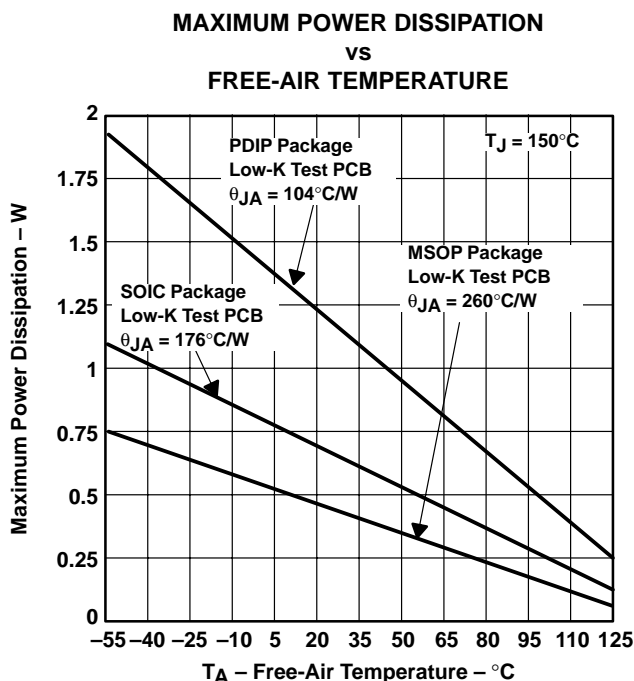

NOTE A: Results are with no air flow and using JEDEC Standard Low-K test PCB.

Figure 40. Maximum Power Dissipation vs Free-Air Temperature

MECHANICAL DATA

D (R-PDSO-G**)

PLASTIC SMALL-OUTLINE PACKAGE

14 PIN SHOWN

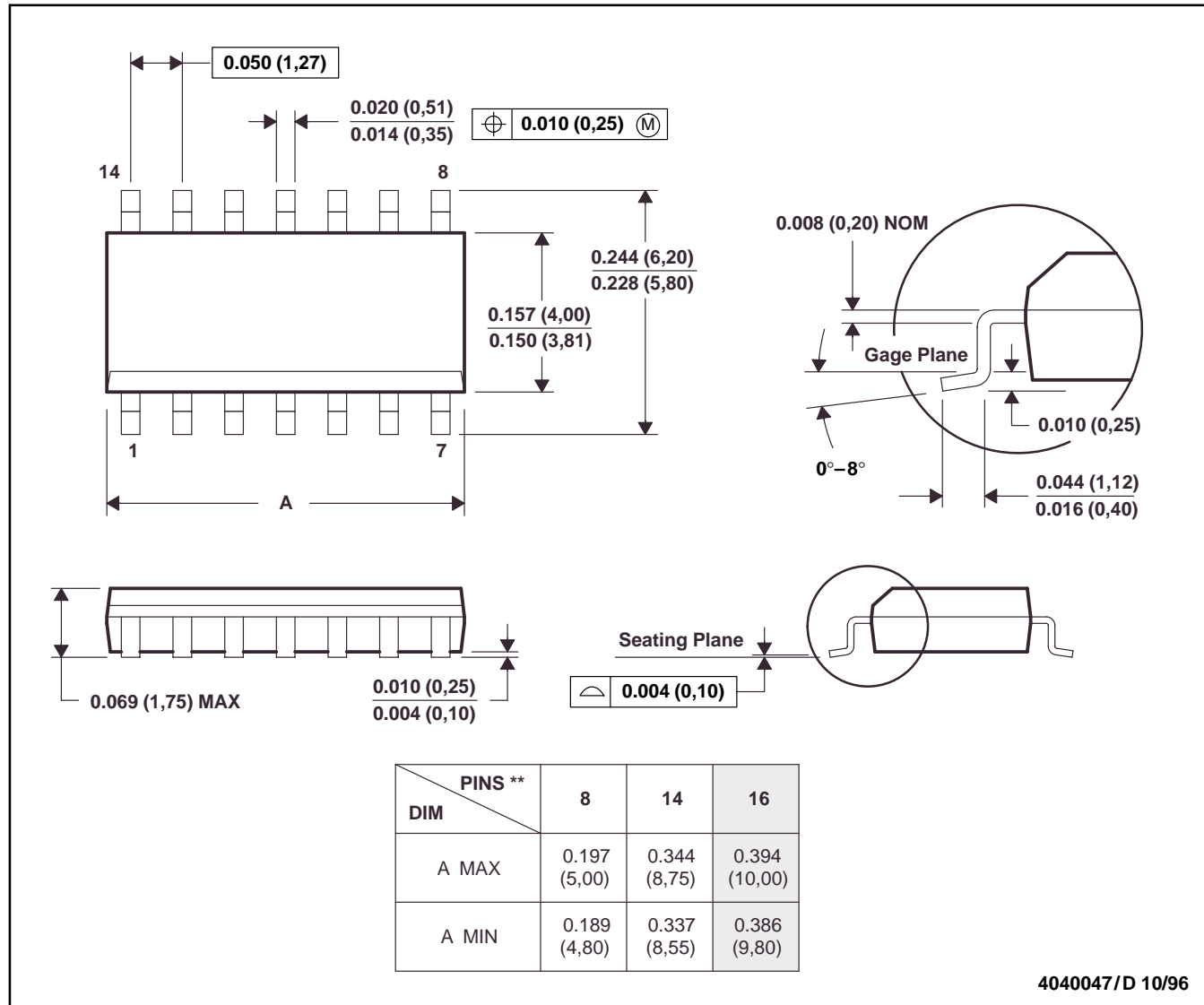

- NOTES: A. All linear dimensions are in inches (millimeters).
 B. This drawing is subject to change without notice.
 C. Body dimensions do not include mold flash or protrusion, not to exceed 0.006 (0,15).

MECHANICAL INFORMATION

DGK (R-PDSO-G8)

PLASTIC SMALL-OUTLINE PACKAGE

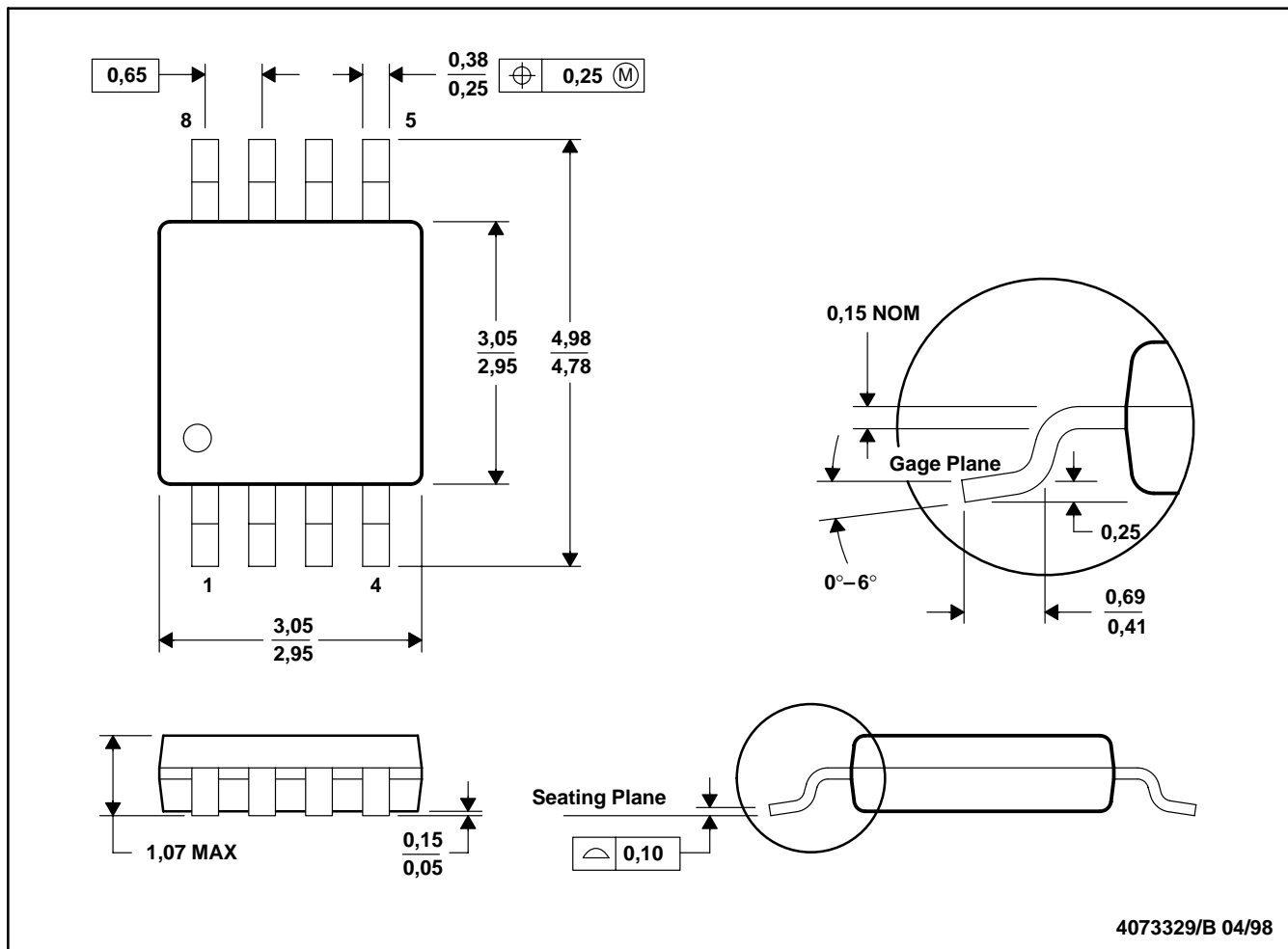

4073329/B 04/98

- NOTES: A. All linear dimensions are in millimeters.
 B. This drawing is subject to change without notice.
 C. Body dimensions do not include mold flash or protrusion.
 D. Falls within JEDEC MO-187

MECHANICAL INFORMATION

N (R-PDIP-T)**

PLASTIC DUAL-IN-LINE PACKAGE

16 PINS SHOWN

DIM \ PINS **	14	16	18	20
A MAX	0.775 (19,69)	0.775 (19,69)	0.920 (23,37)	0.975 (24,77)
A MIN	0.745 (18,92)	0.745 (18,92)	0.850 (21,59)	0.940 (23,88)

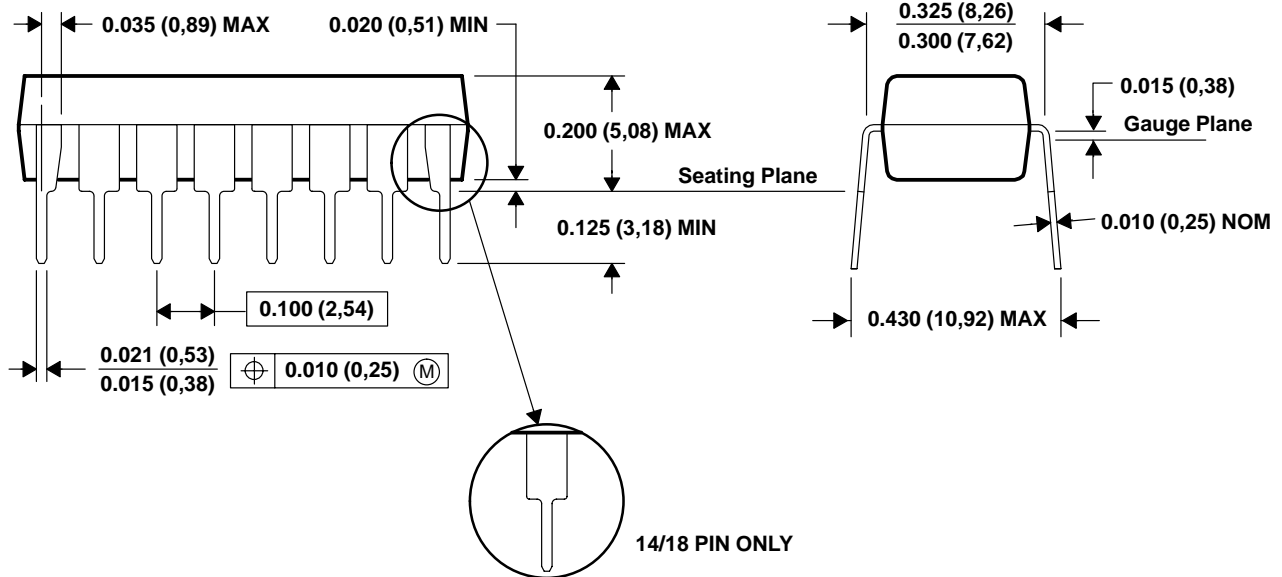
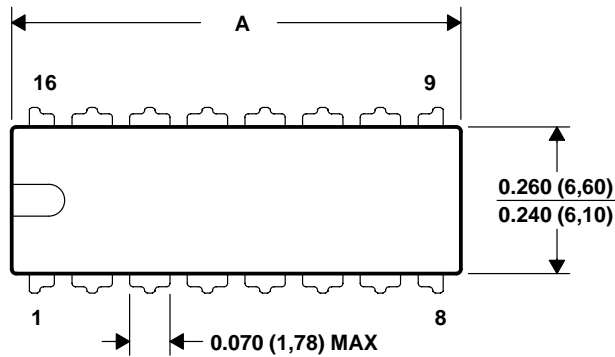

4040049/D 02/00

- NOTES: A. All linear dimensions are in inches (millimeters).
 B. This drawing is subject to change without notice.
 C. Falls within JEDEC MS-001 (20-pin package is shorter than MS-001).

MECHANICAL INFORMATION

P (R-PDIP-T8)

PLASTIC DUAL-IN-LINE PACKAGE

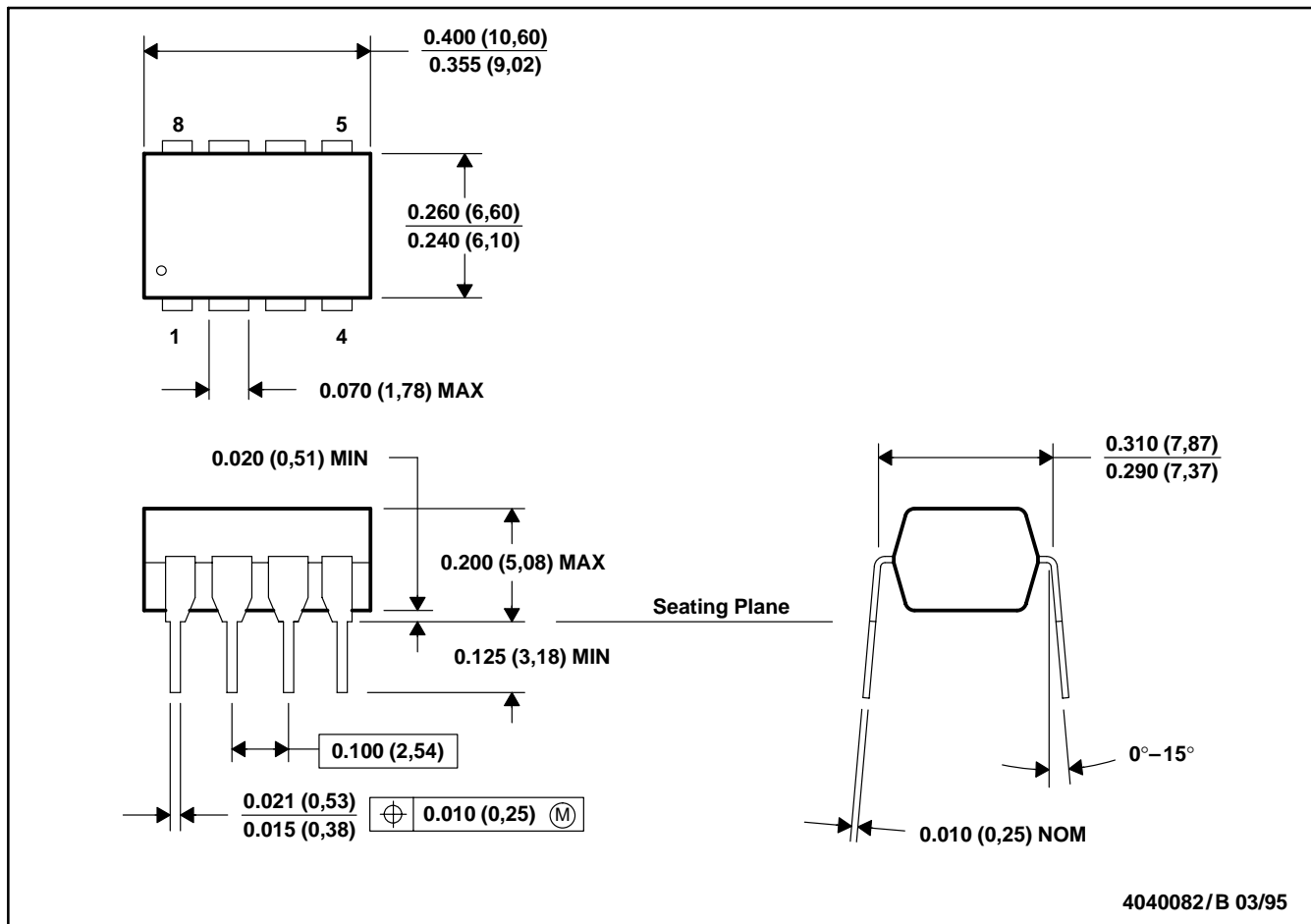

- NOTES: A. All linear dimensions are in inches (millimeters).
B. This drawing is subject to change without notice.
C. Falls within JEDEC MS-001

MECHANICAL INFORMATION

PW (R-PDSO-G**)

PLASTIC SMALL-OUTLINE PACKAGE

14 PINS SHOWN

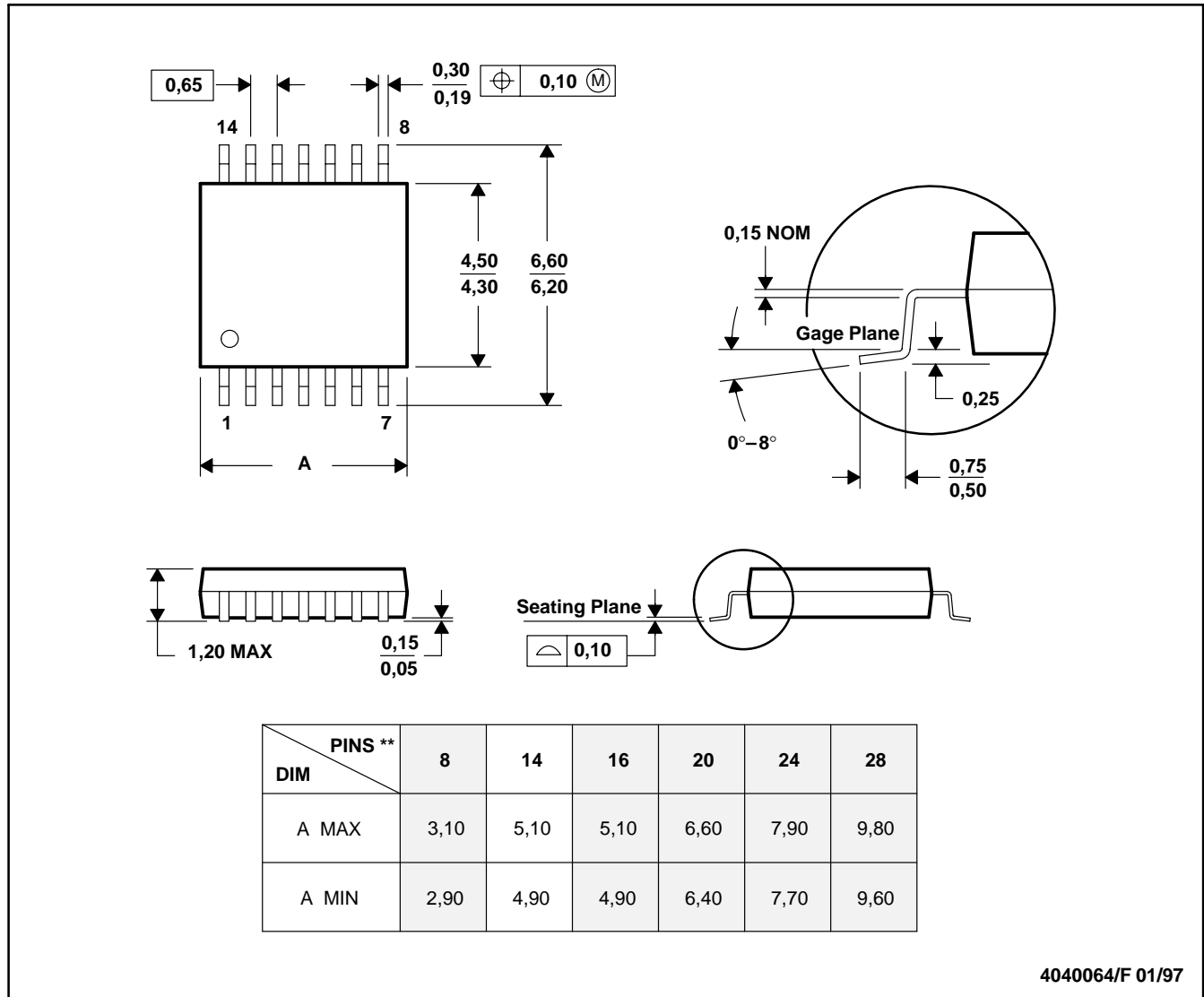

- NOTES: A. All linear dimensions are in millimeters.
 B. This drawing is subject to change without notice.
 C. Body dimensions do not include mold flash or protrusion not to exceed 0,15.
 D. Falls within JEDEC MO-153

PACKAGING INFORMATION

Orderable Device	Status (1)	Package Type	Package Drawing	Pins	Package Qty	Eco Plan (2)	Lead finish/ Ball material (6)	MSL Peak Temp (3)	Op Temp (°C)	Device Marking (4/5)	Samples
TLV2702ID	ACTIVE	SOIC	D	8	75	RoHS & Green	NIPDAU	Level-1-260C-UNLIM	-40 to 125	2702I	Samples
TLV2702IDGK	ACTIVE	VSSOP	DGK	8	80	RoHS & Green	NIPDAU	Level-1-260C-UNLIM	-40 to 125	AQF	Samples
TLV2702IDGKG4	ACTIVE	VSSOP	DGK	8	80	RoHS & Green	NIPDAU	Level-1-260C-UNLIM	-40 to 125	AQF	Samples
TLV2702IP	ACTIVE	PDIP	P	8	50	RoHS & Green	NIPDAU	N / A for Pkg Type	-40 to 125	TLV2702I	Samples
TLV2704ID	ACTIVE	SOIC	D	14	50	RoHS & Green	NIPDAU	Level-1-260C-UNLIM	-40 to 125	2704I	Samples

(1) The marketing status values are defined as follows:

ACTIVE: Product device recommended for new designs.

LIFEBUY: TI has announced that the device will be discontinued, and a lifetime-buy period is in effect.

NRND: Not recommended for new designs. Device is in production to support existing customers, but TI does not recommend using this part in a new design.

PREVIEW: Device has been announced but is not in production. Samples may or may not be available.

OBSELETE: TI has discontinued the production of the device.

(2) **RoHS:** TI defines "RoHS" to mean semiconductor products that are compliant with the current EU RoHS requirements for all 10 RoHS substances, including the requirement that RoHS substance do not exceed 0.1% by weight in homogeneous materials. Where designed to be soldered at high temperatures, "RoHS" products are suitable for use in specified lead-free processes. TI may reference these types of products as "Pb-Free".

RoHS Exempt: TI defines "RoHS Exempt" to mean products that contain lead but are compliant with EU RoHS pursuant to a specific EU RoHS exemption.

Green: TI defines "Green" to mean the content of Chlorine (Cl) and Bromine (Br) based flame retardants meet JS709B low halogen requirements of <=1000ppm threshold. Antimony trioxide based flame retardants must also meet the <=1000ppm threshold requirement.

(3) MSL, Peak Temp. - The Moisture Sensitivity Level rating according to the JEDEC industry standard classifications, and peak solder temperature.

(4) There may be additional marking, which relates to the logo, the lot trace code information, or the environmental category on the device.

(5) Multiple Device Markings will be inside parentheses. Only one Device Marking contained in parentheses and separated by a "~" will appear on a device. If a line is indented then it is a continuation of the previous line and the two combined represent the entire Device Marking for that device.

(6) Lead finish/Ball material - Orderable Devices may have multiple material finish options. Finish options are separated by a vertical ruled line. Lead finish/Ball material values may wrap to two lines if the finish value exceeds the maximum column width.

Important Information and Disclaimer: The information provided on this page represents TI's knowledge and belief as of the date that it is provided. TI bases its knowledge and belief on information provided by third parties, and makes no representation or warranty as to the accuracy of such information. Efforts are underway to better integrate information from third parties. TI has taken and continues to take reasonable steps to provide representative and accurate information but may not have conducted destructive testing or chemical analysis on incoming materials and chemicals. TI and TI suppliers consider certain information to be proprietary, and thus CAS numbers and other limited information may not be available for release.

In no event shall TI's liability arising out of such information exceed the total purchase price of the TI part(s) at issue in this document sold by TI to Customer on an annual basis.

TUBE

*All dimensions are nominal

Device	Package Name	Package Type	Pins	SPQ	L (mm)	W (mm)	T (μm)	B (mm)
TLV2702ID	D	SOIC	8	75	507	8	3940	4.32
TLV2702IP	P	PDIP	8	50	506	13.97	11230	4.32
TLV2704ID	D	SOIC	14	50	507	8	3940	4.32

IMPORTANT NOTICE AND DISCLAIMER

TI PROVIDES TECHNICAL AND RELIABILITY DATA (INCLUDING DATA SHEETS), DESIGN RESOURCES (INCLUDING REFERENCE DESIGNS), APPLICATION OR OTHER DESIGN ADVICE, WEB TOOLS, SAFETY INFORMATION, AND OTHER RESOURCES "AS IS" AND WITH ALL FAULTS, AND DISCLAIMS ALL WARRANTIES, EXPRESS AND IMPLIED, INCLUDING WITHOUT LIMITATION ANY IMPLIED WARRANTIES OF MERCHANTABILITY, FITNESS FOR A PARTICULAR PURPOSE OR NON-INFRINGEMENT OF THIRD PARTY INTELLECTUAL PROPERTY RIGHTS.

These resources are intended for skilled developers designing with TI products. You are solely responsible for (1) selecting the appropriate TI products for your application, (2) designing, validating and testing your application, and (3) ensuring your application meets applicable standards, and any other safety, security, regulatory or other requirements.

These resources are subject to change without notice. TI grants you permission to use these resources only for development of an application that uses the TI products described in the resource. Other reproduction and display of these resources is prohibited. No license is granted to any other TI intellectual property right or to any third party intellectual property right. TI disclaims responsibility for, and you will fully indemnify TI and its representatives against, any claims, damages, costs, losses, and liabilities arising out of your use of these resources.

TI's products are provided subject to [TI's Terms of Sale](#) or other applicable terms available either on [ti.com](https://www.ti.com) or provided in conjunction with such TI products. TI's provision of these resources does not expand or otherwise alter TI's applicable warranties or warranty disclaimers for TI products.

TI objects to and rejects any additional or different terms you may have proposed.

Mailing Address: Texas Instruments, Post Office Box 655303, Dallas, Texas 75265
Copyright © 2024, Texas Instruments Incorporated

Looking for pricing, stock, or lifecycle information?

Click below to explore more details on WIN SOURCE:

 [View TLV2702ID](#) on WIN SOURCE

 [Texas Instruments](#) Information

Optimize Your Supply Chain with WIN SOURCE Solutions

-  Global Sourcing Solution
-  Obsolete Management
-  Cost Control Management
-  Shortage Management
-  Alternative Solution
-  Excess Inventory Management