



**THE DATASHEET OF
TLC271ACS-13**



CMOS PROGRAMMABLE LOW POWER OPERATIONAL AMPLIFIERS

New Product

Description

The TLC271 operational amplifier combines a wide range of input offset voltage grades with low offset voltage drift and high input impedance. In addition, the TLC271 offers a bias-select mode that allows the user to select the best combination of power dissipation and AC performance for a particular application.

Using the bias-select option, these devices can be programmed to fit a wide range of applications. Three offset voltage grades are available, ranging from the low-cost TLC271 (10mV) to the TLC271B (2mV) low-offset version. The devices are offered in both commercial and industrial operating temperature ranges.

The extremely high input impedance and low bias currents, in conjunction with good common-mode and supply voltage rejection make these devices an excellent choice for high performance designs.

The devices also feature low-voltage single-supply operation with a common-mode input voltage range which includes the negative rail.

Features

- Wide range of supply voltages over specified temperature range:
 - 0°C to 70°C . . . 3 V to 16 V
 - 40°C to 85°C . . . 4 V to 16 V
- Single-Supply Operation
- Common-Mode Input Voltage Range
- Extends Below the Negative Rail
- Low Noise:
 - 20 nV/√Hz Typical @ f = 1kHz
 - (High-Bias Mode)
- Output Voltage Range Includes Negative Rail
- High Input Impedance
- ESD-Protection Circuitry
- Designed-In Latch-Up Immunity
- **Totally Lead-Free & Fully RoHS Compliant (Notes 1 & 2)**
- **Halogen and Antimony Free. "Green" Device (Note 3)**

Notes: 1. No purposely added lead. Fully EU Directive 2002/95/EC (RoHS) & 2011/65/EU (RoHS 2) compliant.
 2. See http://www.diodes.com/quality/lead_free.html for more information about Diodes Incorporated's definitions of Halogen- and Antimony-free, "Green" and Lead-free.
 3. Halogen- and Antimony-free "Green" products are defined as those which contain <900ppm bromine, <900ppm chlorine (<1500ppm total Br + Cl) and <1000ppm antimony compounds.

Pin Assignments

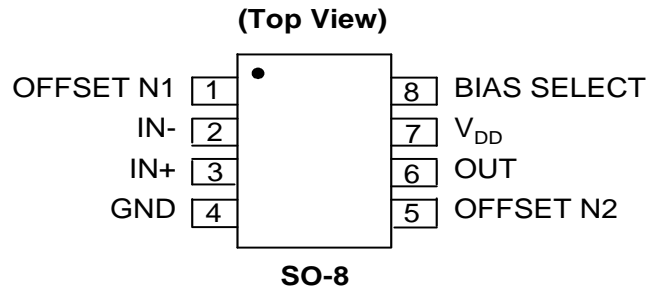

Applications

With the programmability options of the TLC271, a designer can choose a very low current option allowing for extended battery life or choose a higher current option for more performance. It is possible to switch performance modes as the application demands change.

The TLC271 is well suited for many consumer audio, industrial and other low power applications.

- Audio
 - Microphone Preamplifier
 - Filtering – Equalizers
 - Signal Amplification
- Industrial
 - Power Supply
 - Instrumentation
 - Metering
- Medical
 - Portable Meters and Measurement
 - Instrumentation

Ordering Information

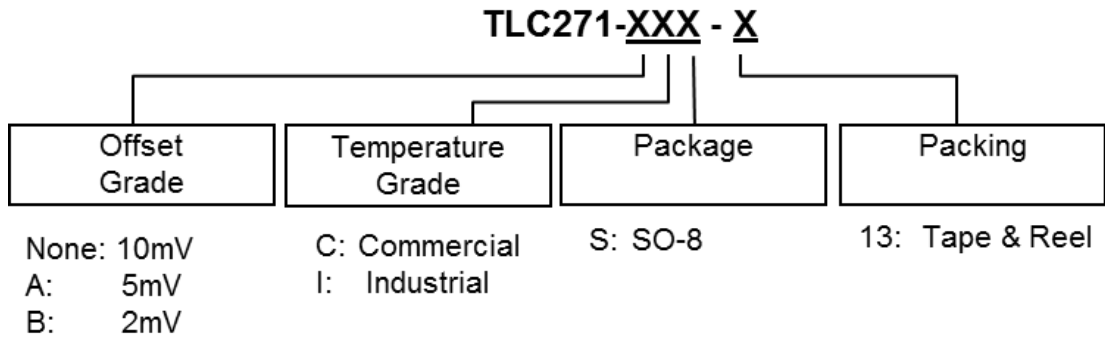

Device	Package Code	Offset Voltage	Operating Temperature Range	Packaging (Note 4)	13" Tape and Reel	
					Quantity	Part Number Suffix
TLC271CS-13	S	10mV	0 to 70°C	SO-8	2500/Tape & Reel	-13
TLC271ACS-13	S	5mV	0 to 70°C	SO-8	2500/Tape & Reel	-13
TLC271BCS-13	S	2mV	0 to 70°C	SO-8	2500/Tape & Reel	-13
TLC271IS-13	S	10mV	-40 to 85°C	SO-8	2500/Tape & Reel	-13
TLC271AIS-13	S	5mV	-40 to 85°C	SO-8	2500/Tape & Reel	-13
TLC271BIS-13	S	2mV	-40 to 85°C	SO-8	2500/Tape & Reel	-13

Note: 4. Pad layout as shown on Diodes Inc. suggested pad layout document AP02001, which can be found on our website at <http://www.diodes.com/datasheets/ap02001.pdf>.

Pin Descriptions

Pin Name	Pin number	Description
OFFSET N1	1	Offset Control Inverting Input
IN-	2	Inverting Input
IN+	3	Non-Inverting Input
GND	4	Ground
OFFSET N2	5	Offset Control Non-Inverting Input
OUT	6	Output
V _{DD}	7	Supply
BIAS SELECT	8	Bias Mode Select

Absolute Maximum Ratings (Notes 5, 6, 7, 8, 9)

Symbol	Parameter		Rating	Unit
V_{DD}	Supply Voltage (Note 6)		18	V
V_{ID}	Differential Input Voltage (Note 7)		$\pm V_{DD}$	V
V_{IN}	Input Voltage Range (either input)		-0.3 to V_{DD}	V
I_{IN}	Input Current		± 5	mA
I_o	Output Current		± 30	mA
	Output Short-Circuit to GND (Note 8)		Continuous	—
P_D	Power Dissipation (Note 9)		1065	mW
T_A	Operating Temperature Range	C Grade	0 to +70	°C
		I Grade	-40 to +85	
T_J	Operating Junction Temperature		150	°C
T_{ST}	Storage Temperature Range		-65 to +150	°C
ESD HBM	Human Body Model ESD Protection (1.5k Ω in series with 100pF)		1.5	kV

- Notes:
- Stresses beyond those listed under absolute maximum ratings may cause permanent damage to the device. These are stress ratings only; functional operation of the device at these or any other conditions beyond those indicated under recommended operating conditions is not implied. Exposure to absolute-maximum-rated conditions for extended periods may affect device reliability.
 - All voltage values, except differential voltages, are with respect to ground.
 - Differential input voltages are at IN+ with respect to IN-.
 - The output may be shorted to either supply. Temperature and/or supply voltages must be limited to ensure that the maximum dissipation rating is not exceeded.
 - For operating at high temperatures, the TLC271 must be derated 8.5mW/°C to zero based on a +150°C maximum junction temperature and a thermal resistance of +117 °C/W when the device is soldered to a printed circuit board, operating in a still air ambient.

Recommended Operating Conditions

Symbol	Parameter		C grade		I grade		Unit
			Min	Max	Min	Max	
V_{DD}	Supply Voltage		3	16	4	16	V
V_{IC}	Common Mode Input Voltage	$V_{DD} = 5V$	-0.2	3.5	-0.2	3.5	V
		$V_{DD} = 10V$	-0.2	8.5	-0.2	8.5	
T_A	Operating Free Air Temperature		0	+70	-40	+85	°C

Electrical Characteristics

High Bias Mode			Conditions	T _A	TLC271C, TLC271AC, TLC271BC						Unit
Parameter					V _{DD} = 5V			V _{DD} = 10V			
					Min	Typ	Max	Min	Typ	Max	
V _{IO}	Input Offset Voltage	TLC271C	V _o = 1.4V, V _{IC} = 0V, R _S = 50Ω, R _L = 10kΩ	+25°C	—	1.1	10	—	1.1	10	mV
				0 to +70°C	—	—	12	—	—	12	
		TLC271AC		+25°C	—	0.9	5	—	0.9	5	
				0 to 70°C	—	—	6.5	—	—	6.5	
		TLC271BC		25°C	—	0.34	2	—	0.39	2	
				0 to +70°C	—	—	3	—	—	3	
α _{VI}	Average Temperature Coefficient of Input Offset Voltage		—	+25°C to 70°C	1.8			2			μV/°C
I _{IO}	Input Offset Current (Note 10)		V _o = V _{DD} /2, V _{IC} = V _{DD} /2	+25°C	—	0.1	60	—	0.1	60	pA
				+70°C	—	7	300	—	7	300	
I _{IB}	Input Bias Current (Note 10)		V _o = V _{DD} /2, V _{IC} = V _{DD} /2	+25°C	—	0.6	60	—	0.7	60	pA
				+70°C	—	40	600	—	50	600	
V _{ICR}	Common Mode Input Voltage (Note 11)		—	+25°C	-0.2 to 4	-0.3 to 4.2	—	-0.2 to 9	-0.3 to 9.2	—	V
				0 to +70°C	-0.2 to 3.5	—	—	-0.2 to 8.5	—	—	—
V _{OH}	High Level Output Voltage		V _{ID} = 100mV, R _L = 10kΩ	+25°C	3.2	3.8	—	8	8.5	—	V
				0°C	3	3.8	—	7.8	8.5	—	
				+70°C	3	3.8	—	7.8	8.4	—	
V _{OL}	Low Level Output Voltage		V _{ID} = -100mV, I _L = 0	+25°C	—	0	50	—	0	50	mV
				0°C	—	0	50	—	0	50	
				+70°C	—	0	50	—	0	50	
A _{VD}	Large Signal Differential Voltage Gain		R _L = 10kΩ (Note 12)	+25°C	5	23	—	10	36	—	V/mV
				0°C	4	27	—	7.5	42	—	
				+70°C	4	20	—	7.5	32	—	
CMRR	Common Mode Rejection Ratio		V _{IC} = V _{ICRmin}	+25°C	65	80	—	65	85	—	dB
				0°C	60	84	—	60	88	—	
				+70°C	60	85	—	60	88	—	
k _{SVR}	Supply Voltage Rejection Ratio (ΔV _{DD} /ΔV _{IO})		V _{DD} = 5V to 10V, V _o = 1.4V	+25°C	65	95	—	65	95	—	dB
				0°C	60	94	—	60	94	—	
				+70°C	60	96	—	60	96	—	
I _{I(SEL)}	Input Current (BIAS SELECT)		V _{I(SEL)} = 0	+25°C	—	-1.4	—	—	-1.9	—	μA
I _{DD}	Supply Current		V _o = V _{DD} /2, V _{IC} = V _{DD} /2, No load	+25°C	—	675	1600	—	950	2000	μA
				0°C	—	775	1800	—	1125	2200	
				+70°C	—	575	1300	—	750	1700	

Notes: 10. The typical values of input bias current and input offset current below 5pA were calculated.
 11. This range also applies to each input individually.
 12. At V_{DD} = 5V, V_o = 0.25V to 2V; at V_{DD} = 10V, V_o = 1V to 6V.

Electrical Characteristics

High bias mode			Conditions	T _A	TLC271I, TLC271AI, TLC271BI						Unit
Parameter					V _{DD} = 5V			V _{DD} = 10V			
					Min	Typ	Max	Min	Typ	Max	
V _{IO}	Input Offset Voltage	TLC271I	V _o = 1.4V, V _{IC} = 0V, R _S = 50Ω, R _L = 10kΩ	+25 °C	—	1.1	10	—	1.1	10	mV
				-40 to 85 °C	—	—	13	—	—	13	
		TLC271AI		+25 °C	—	0.9	5	—	0.9	5	
				-40 to 85 °C	—	—	7	—	—	7	
		TLC271BI		+25 °C	—	0.34	2	—	0.39	2	
				-40 to 85 °C	—	—	3.5	—	—	3.5	
α _{VIO}	Average Temperature Coefficient of Input Offset Voltage	—	—	+25 to 85 °C	1.8			2			μV/°C
I _{IO}	Input Offset Current (Note 13)	—	V _o = V _{DD} /2, V _{IC} = V _{DD} /2	+25 °C	—	0.1	60	—	0.1	60	pA
				+85 °C	—	24	1000	—	26	1000	
I _{IB}	Input Bias Current (Note 13)	—	V _o = V _{DD} /2, V _{IC} = V _{DD} /2	+25 °C	—	0.6	60	—	0.7	60	pA
				+85 °C	—	200	2000	—	220	2000	
V _{ICR}	Common Mode Input Voltage (Note 14)	—	—	+25 °C	-0.2 to 4	-0.3 to 4.2	—	-0.2 to 9	-0.3 to 9.2	—	V
				-40 to +85 °C	-0.2 to 3.5	—	—	-0.2 to 8.5	—	—	—
V _{OH}	High Level Output Voltage	—	V _{ID} = 100mV, R _L = 10kΩ	+25 °C	3.2	3.8	—	8	8.5	—	V
				-40 °C	3	3.8	—	7.8	8.5	—	
				+85 °C	3	3.8	—	7.8	8.5	—	
V _{OL}	Low Level Output Voltage	—	V _{ID} = -100mV, I _L = 0	+25 °C	—	0	50	—	0	50	mV
				-40 °C	—	0	50	—	0	50	
				+85 °C	—	0	50	—	0	50	
A _{VD}	Large Signal Differential Voltage Gain	—	R _L = 10kΩ (Note 15)	+25 °C	5	23	—	10	36	—	V/mV
				-40 °C	3.5	32	—	7	46	—	
				+85 °C	3.5	19	—	7	31	—	
CMRR	Common Mode Rejection Ratio	—	V _{IC} = V _{ICRmin}	+25 °C	65	80	—	65	85	—	dB
				-40 °C	60	81	—	60	87	—	
				+85 °C	60	86	—	60	88	—	
k _{SVR}	Supply Voltage Rejection Ratio (ΔV _{DD} /ΔV _{IO})	—	V _{DD} = 5V to 10V, V _o = 1.4V	+25 °C	65	95	—	65	95	—	dB
				-40 °C	60	92	—	60	92	—	
				+85 °C	60	96	—	60	96	—	
I _{I(SEL)}	Input Current (BIAS SELECT)	—	V _{I(SEL)} = 0	+25 °C	—	-1.4	—	—	-1.9	—	μA
I _{DD}	Supply Current	—	V _o = V _{DD} /2, V _{IC} = V _{DD} /2, No load	+25 °C	—	675	1600	—	950	2000	μA
				-40 °C	—	950	2200	—	1375	2500	
				+85 °C	—	525	1200	—	725	1600	

Notes: 13. The typical values of input bias current and input offset current below 5pA were calculated.
 14. This range also applies to each input individually.
 15. At V_{DD} = 5 V, V_o = 0.25 V to 2 V; at V_{DD} = 10 V, V_o = 1 V to 6 V.

Electrical Characteristics

High bias mode: $V_{DD} = 5V$								
Parameter		Conditions		T_A	TLC271C, TLC271AC, TLC271BC			Unit
					Min	Typ	Max	
SR	Slew Rate at Unity Gain	$R_L = 10k\Omega$, $C_L = 20pF$	$V_{I(PP)} = 1V$	+25°C	—	3.6	—	V/ μ s
				0°C	—	4	—	
				+70°C	—	3	—	
		See Figure 92	$V_{I(PP)} = 2.5V$	+25°C	—	2.9	—	
				0°C	—	3.1	—	
				+70°C	—	2.5	—	
V_n	Equivalent Input Noise Voltage	$F = 1kHz$, $R_S = 20\Omega$ See Figure 93		+25°C	—	25	—	nV/ \sqrt{Hz}
B_M	Maximum Output Swing Bandwidth	$V_o = V_{OH}$, $C_L = 20pF$, $R_L = 10k\Omega$ See Figure 92		+25°C	—	200	—	kHz
				0°C	—	220	—	
				+70°C	—	140	—	
B_1	Unity Gain Bandwidth	$V_I = 10mV$, $C_L = 20pF$ See Figure 94		+25°C	—	2.2	—	MHz
				0°C	—	2.5	—	
				+70°C	—	1.8	—	
ϕ_m	Phase Margin	$F = B_1$, $V_I = 10mV$, $C_L = 20pF$ See Figure 94		+25°C	—	49°	—	—
				0°C	—	50°	—	
				+70°C	—	46°	—	
High bias mode: $V_{DD} = 10V$								
Parameter		Conditions		T_A	TLC271C, TLC271AC, TLC271BC			Unit
					Min	Typ	Max	
SR	Slew Rate at Unity Gain	$R_L = 10k\Omega$, $C_L = 20pF$ See Figure 92	$V_{I(PP)} = 1V$	+25°C	—	5.3	—	V/ μ s
				0°C	—	5.9	—	
				+70°C	—	4.3	—	
		See Figure 92	$V_{I(PP)} = 5.5V$	+25°C	—	4.6	—	
				0°C	—	5.1	—	
				+70°C	—	3.8	—	
V_n	Equivalent Input Noise Voltage	$F = 1kHz$, $R_S = 20\Omega$ See Figure 93		+25°C	—	25	—	nV/ \sqrt{Hz}
B_M	Maximum Output Swing Bandwidth	$V_o = V_{OH}$, $C_L = 20pF$, $R_L = 10k\Omega$ See Figure 92		+25°C	—	200	—	kHz
				0°C	—	220	—	
				+70°C	—	140	—	
B_1	Unity Gain Bandwidth	$V_I = 10mV$, $C_L = 20pF$ See Figure 94		+25°C	—	2.2	—	MHz
				0°C	—	2.5	—	
				+70°C	—	1.8	—	
ϕ_m	Phase Margin	$F = B_1$, $V_I = 10mV$, $C_L = 20pF$ See Figure 94		+25°C	—	49°	—	—
				0°C	—	50°	—	
				+70°C	—	46°	—	

Electrical Characteristics

High bias mode: $V_{DD} = 5V$								
Parameter		Conditions		T_A	TLC271I, TLC271AI, TLC271BI			Unit
					Min	Typ	Max	
SR	Slew rate at unity gain	$R_L = 10k\Omega$, $C_L = 20pF$ See Figure 92	$V_{I(PP)} = 1V$	+25°C	—	3.6	—	V/ μ s
				-40°C	—	4.5	—	
				+85°C	—	2.8	—	
			$V_{I(PP)} = 2.5V$	+25°C	—	2.9	—	
				-40°C	—	3.5	—	
				+85°C	—	2.3	—	
V_n	Equivalent input noise voltage	$F = 1kHz$, $R_S = 20\Omega$ See Figure 93	+25°C	—	25	—	nV/ \sqrt{Hz}	
B^*M	Maximum output swing bandwidth	$V_o = V_{OH}$, $C_L = 20pF$, $R_L = 10k\Omega$ See Figure 92	+25°C	—	320	—	kHz	
			-40°C	—	380	—		
			+85°C	—	250	—		
B_1	Unity gain bandwidth	$V_I = 10mV$, $C_L = 20pF$ See Figure 94	+25°C	—	1.7	—	MHz	
			-40°C	—	2.6	—		
			+85°C	—	1.2	—		
ϕ_m	Phase margin	$F = B_1$, $V_I = 10mV$, $C_L = 20pF$ See Figure 94	+25°C	—	46°	—	—	
			-40°C	—	49°	—		
			+85°C	—	43°	—		
High bias mode: $V_{DD} = 10V$								
Parameter		Conditions		T_A	TLC271I, TLC271AI, TLC271BI			Unit
					Min	Typ	Max	
SR	Slew rate at unity gain	$R_L = 10k\Omega$, $C_L = 20pF$ See Figure 92	$V_{I(PP)} = 1V$	+25°C	—	5.3	—	V/ μ s
				-40°C	—	6.8	—	
				+85°C	—	4	—	
			$V_{I(PP)} = 5.5V$	+25°C	—	4.6	—	
				-40°C	—	5.8	—	
				+85°C	—	3.5	—	
V_n	Equivalent input noise voltage	$F = 1kHz$, $R_S = 20\Omega$ See Figure 93	+25°C	—	25	—	nV/ \sqrt{Hz}	
B^*M	Maximum output swing bandwidth	$V_o = V_{OH}$, $C_L = 20pF$, $R_L = 10k\Omega$ See Figure 92	+25°C	—	200	—	kHz	
			-40°C	—	260	—		
			+85°C	—	130	—		
B_1	Unity gain bandwidth	$V_I = 10mV$, $C_L = 20pF$ See Figure 94	+25°C	—	2.2	—	MHz	
			-40°C	—	3.1	—		
			+85°C	—	1.7	—		
ϕ_m	Phase margin	$F = B_1$, $V_I = 10mV$, $C_L = 20pF$ See Figure 94	+25°C	—	49°	—	—	
			-40°C	—	52°	—		
			+85°C	—	46°	—		

Electrical Characteristics

Medium bias mode											
Parameter			Conditions	T _A	TLC271C, TLC271AC, TLC271BC						Unit
					V _{DD} = 5V			V _{DD} = 10V			
					Min	Typ	Max	Min	Typ	Max	
V _{IO}	Input Offset Voltage	TLC271C	V _o = 1.4V, V _{IC} = 0V, R _S = 50Ω, R _L = 100kΩ	+25°C	—	1.1	10	—	1.1	10	mV
		0 to +70°C		—	—	12	—	—	12		
		+25°C		—	0.9	5	—	0.9	5		
		0 to +70°C		—	—	6.5	—	—	6.5		
α _{VIO}	Average temperature coefficient of input offset voltage			25 to +70°C	1.7			2.1			μV/°C
I _{IO}	Input offset current (Note 16)		V _o = V _{DD} /2, V _{IC} = V _{DD} /2	+25°C	—	0.1	60	—	0.1	60	pA
				+70°C	—	7	300	—	7	300	
I _{IB}	Input bias current (Note 16)		V _o = V _{DD} /2, V _{IC} = V _{DD} /2	+25°C	—	0.6	60	—	0.7	60	pA
				+70°C	—	40	600	—	50	600	
V _{ICR}	Common mode input voltage (Note 17)			+25°C	-0.2 to 4	-0.3 to 4.2	—	-0.2 to 9	-0.3 to 9.2	—	V
				0 to +70°C	-0.2 to 3.5	—	—	-0.2 to 8.5	—	—	V
V _{OH}	High level output voltage		V _{ID} = 100mV, R _L = 100kΩ	+25°C	3.2	3.9	—	8	8.7	—	V
				0°C	3	3.9	—	7.8	8.7	—	
				+70°C	3	4	—	7.8	8.7	—	
V _{OL}	Low level output voltage		V _{ID} = -100mV, I _L = 0	+25°C	—	0	50	—	0	50	mV
				0°C	—	0	50	—	0	50	
				+70°C	—	0	50	—	0	50	
A _{VD}	Large signal differential voltage gain		R _L = 100kΩ (Note 18)	+25°C	25	170	—	25	275	—	V/mV
				0°C	15	200	—	15	320	—	
				+70°C	15	140	—	15	230	—	
CMRR	Common mode rejection ratio		V _{IC} = V _{ICRmin}	+25°C	65	91	—	65	94	—	dB
				0°C	60	91	—	60	94	—	
				+70°C	60	92	—	60	94	—	
k _{SVR}	Supply voltage rejection ratio (ΔV _{DD} /ΔV _{IO})		V _{DD} = 5V to 10V, V _o = 1.4V	+25°C	70	93	—	70	93	—	dB
				0°C	60	92	—	60	92	—	
				+70°C	60	94	—	60	94	—	
I _{I(SEL)}	Input current (BIAS SELECT)		V _{I(SEL)} = 0	+25°C	—	-130	—	—	-160	—	nA
I _{DD}	Supply current		V _o = V _{DD} /2, V _{IC} = V _{DD} /2, No load	+25°C	—	105	280	—	143	300	μA
				0°C	—	125	320	—	173	400	
				+70°C	—	85	220	—	110	280	

Notes: 16. The typical values of input bias current and input offset current below 5pA were calculated.
 17. This range also applies to each input individually.
 18. At V_{DD} = 5 V, V_o = 0.25 V to 2 V; at V_{DD} = 10 V, V_o = 1 V to 6 V.

Electrical Characteristics

Medium bias mode			Conditions	T _A	TLC271I, TLC271AI, TLC271BI						Unit
Parameter					V _{DD} = 5V			V _{DD} = 10V			
					Min	Typ	Max	Min	Typ	Max	
V _{IO}	Input Offset Voltage	TLC271I	V _o = 1.4V, V _{IC} = 0V, R _S = 50Ω, R _L = 100kΩ	+25 °C	—	1.1	10	—	1.1	10	mV
				-40 to +85 °C	—	—	13	—	—	13	
		TLC271AI		+25 °C	—	0.9	5	—	0.9	5	
				-40 to +85 °C	—	—	7	—	—	7	
		TLC271BI		+25 °C	—	0.25	2	—	0.26	2	
				-40 to +85 °C	—	—	3.5	—	—	3.5	
α _{VIO}	Average temperature coefficient of input offset voltage			+25 to +85 °C	1.7			2.1		μV/°C	
I _{IO}	Input offset current (Note 19)		V _o = V _{DD} /2, V _{IC} = V _{DD} /2	+25 °C	—	0.1	60	—	0.1	60	pA
			+85 °C	—	24	1000	—	26	1000		
I _{IB}	Input bias current (Note 19)		V _o = V _{DD} /2, V _{IC} = V _{DD} /2	+25 °C	—	0.6	60	—	0.7	60	pA
			+85 °C	—	200	2000	—	220	2000		
V _{ICR}	Common mode input voltage (Note 20)			+25 °C	-0.2 to 4	-0.3 to 4.2	—	-0.2 to 9	-0.3 to 9.2	—	V
				-40 to +85 °C	-0.2 to 3.5	—	—	-0.2 to 8.5	—	—	V
V _{OH}	High level output voltage		V _{ID} = 100mV, R _L = 100kΩ	+25 °C	3.2	3.9	—	8	8.7	—	V
				-40 °C	3	3.9	—	7.8	8.7	—	
				+85 °C	3	4	—	7.8	8.7	—	
V _{OL}	Low level output voltage		V _{ID} = -100mV, I _L = 0	+25 °C	—	0	50	—	0	50	mV
				-40 °C	—	0	50	—	0	50	
				+85 °C	—	0	50	—	0	50	
A _{VD}	Large signal differential voltage gain		R _L = 100kΩ (Note 21)	+25 °C	25	170	—	25	275	—	V/mV
				-40 °C	15	270	—	15	390	—	
				+85 °C	15	130	—	15	220	—	
CMRR	Common mode rejection ratio		V _{IC} = V _{ICRmin}	+25 °C	65	91	—	65	94	—	dB
				-40 °C	60	90	—	60	93	—	
				+85 °C	60	90	—	60	94	—	
k _{SVR}	Supply voltage rejection ratio (ΔV _{DD} /ΔV _{IO})		V _{DD} = 5V to 10V, V _o = 1.4V	+25 °C	70	93	—	70	93	—	dB
				-40 °C	60	91	—	60	91	—	
				+85 °C	60	94	—	60	94	—	
I _{I(SEL)}	Input current (BIAS SELECT)		V _{I(SEL)} = 0	+25 °C	—	-130	—	—	-160	—	nA
I _{DD}	Supply current		V _o = V _{DD} /2, V _{IC} = V _{DD} /2, No load	+25 °C	—	105	280	—	143	300	μA
				-40 °C	—	158	400	—	225	450	
				+85 °C	—	80	200	—	103	260	

Notes: 19. The typical values of input bias current and input offset current below 5pA were calculated.
 20. This range also applies to each input individually.
 21. At V_{DD} = 5 V, V_o = 0.25 V to 2 V; at V_{DD} = 10 V, V_o = 1 V to 6 V.

Electrical Characteristics

Medium bias mode: $V_{DD} = 5V$								
Parameter		Conditions		T_A	TLC271C, TLC271AC, TLC271BC			Unit
					Min	Typ	Max	
SR	Slew rate at unity gain	$R_L = 100k\Omega$, $C_L = 20pF$ See Figure 92	$V_{I(PP)} = 1V$	+25°C	—	0.43	—	V/ μ s
				0°C	—	0.46	—	
				+70°C	—	0.36	—	
			$V_{I(PP)} = 2.5V$	+25°C	—	0.4	—	
				0°C	—	0.43	—	
				+70°C	—	0.34	—	
V_n	Equivalent input noise voltage	$F = 1kHz$, $R_S = 20\Omega$	See Figure 93	25°C	—	32	—	nV/ \sqrt{Hz}
$B^{\circ}M$	Maximum output swing bandwidth	$V^{\circ} = V^{\circ}H$, $C_L = 20pF$, $R_L = 100k\Omega$	See Figure 92	+25°C	—	55	—	kHz
				0°C	—	60	—	
				+70°C	—	50	—	
B_1	Unity gain bandwidth	$V_I = 10mV$, $C_L = 20pF$	See Figure 94	+25°C	—	525	—	MHz
				0°C	—	600	—	
				+70°C	—	400	—	
ϕ_m	Phase margin	$F = B_1$, $V_I = 10mV$, $C_L = 20pF$	See Figure 94	+25°C	—	40°	—	—
				0°C	—	41°	—	
				+70°C	—	39°	—	
Medium bias mode: $V_{DD} = 10V$								
Parameter		Conditions		T_A	TLC271C, TLC271AC, TLC271BC			Unit
					Min	Typ	Max	
SR	Slew Rate at Unity Gain	$R_L = 100k\Omega$, $C_L = 20pF$ See Figure 92	$V_{I(PP)} = 1V$	+25°C	—	0.62	—	V/ μ s
				0°C	—	0.67	—	
				+70°C	—	0.51	—	
			$V_{I(PP)} = 5.5V$	+25°C	—	0.56	—	
				0°C	—	0.61	—	
				+70°C	—	0.46	—	
V_n	Equivalent Input Noise Voltage	$F = 1kHz$, $R_S = 20\Omega$	See Figure 93	25°C	—	32	—	nV/ \sqrt{Hz}
$B^{\circ}M$	Maximum Output Swing Bandwidth	$V^{\circ} = V^{\circ}H$, $C_L = 20pF$, $R_L = 100k\Omega$	See Figure 92	+25°C	—	35	—	kHz
				0°C	—	40	—	
				+70°C	—	30	—	
B_1	Unity Gain Bandwidth	$V_I = 10mV$, $C_L = 20pF$	See Figure 94	+25°C	—	635	—	MHz
				0°C	—	710	—	
				+70°C	—	510	—	
ϕ_m	Phase Margin	$F = B_1$, $V_I = 10mV$, $C_L = 20pF$	See Figure 94	+25°C	—	43°	—	—
				0°C	—	44°	—	
				+70°C	—	42°	—	

Electrical Characteristics

Medium bias mode: $V_{DD} = 5V$								
Parameter		Conditions		T_A	TLC271I, TLC271AI, TLC271BI			Unit
					Min	Typ	Max	
SR	Slew rate at unity gain	$R_L = 100k\Omega$, $C_L = 20pF$ See Figure 92	$V_{I(PP)} = 1V$	+25°C	—	0.43	—	V/ μ s
				-40°C	—	0.51	—	
				+85°C	—	0.35	—	
			$V_{I(PP)} = 2.5V$	+25°C	—	0.4	—	
				-40°C	—	0.48	—	
				+85°C	—	0.32	—	
V_n	Equivalent input noise voltage	$F = 1kHz$, $R_S = 20\Omega$ See Figure 93	See	+25°C	—	32	—	nV/ \sqrt{Hz}
B^*M	Maximum output swing bandwidth	$V^* = V^*_H$, $C_L = 20pF$, $R_L = 100k\Omega$ See Figure 92	See	+25°C	—	55	—	kHz
				-40°C	—	75	—	
				+85°C	—	45	—	
B_1	Unity gain bandwidth	$V_I = 10mV$, $C_L = 20pF$ See Figure 94	See	+25°C	—	525	—	MHz
				-40°C	—	770	—	
				+85°C	—	370	—	
ϕ_m	Phase margin	$F = B_1$, $V_I = 10mV$, $C_L = 20pF$ See Figure 94	See Figure	+25°C	—	40°	—	—
				-40°C	—	43°	—	
				+85°C	—	38°	—	
Medium bias mode: $V_{DD} = 10V$								
Parameter		Conditions		T_A	TLC271I, TLC271AI, TLC271BI			Unit
					Min	Typ	Max	
SR	Slew Rate at Unity Gain	$R_L = 100k\Omega$, $C_L = 20pF$ See Figure 92	$V_{I(PP)} = 1V$	+25°C	—	0.62	—	V/ μ s
				-40°C	—	0.77	—	
				+85°C	—	0.47	—	
			$V_{I(PP)} = 5.5V$	+25°C	—	0.56	—	
				-40°C	—	0.7	—	
				+85°C	—	0.44	—	
V_n	Equivalent Input Noise Voltage	$F = 1kHz$, $R_S = 20\Omega$ See Figure 93	See	+25°C	—	32	—	nV/ \sqrt{Hz}
B^*M	Maximum Output Swing Bandwidth	$V^* = V^*_H$, $C_L = 20pF$, $R_L = 100k\Omega$ See Figure 92	See	+25°C	—	35	—	kHz
				-40°C	—	45	—	
				+85°C	—	25	—	
B_1	Unity Gain Bandwidth	$V_I = 10mV$, $C_L = 20pF$ See Figure 94	See	+25°C	—	635	—	MHz
				-400°C	—	880	—	
				+85°C	—	480	—	
ϕ_m	Phase Margin	$F = B_1$, $V_I = 10mV$, $C_L = 20pF$ See Figure 94	See	+25°C	—	43°	—	—
				-40°C	—	46°	—	
				+85°C	—	41°	—	

Electrical Characteristics

Low bias mode											
Parameter			Conditions	T _A	TLC271C, TLC271AC, TLC271BC						Unit
					V _{DD} = 5V			V _{DD} = 10V			
					Min	Typ	Max	Min	Typ.	Max	
V _{I°}	Input Offset Voltage	TLC271C	V _° = 1.4V, V _{IC} = 0V, R _S = 50Ω, R _L = 1MΩ	+25 °C	—	1.1	10	—	1.1	10	mV
		0 to +70 °C		—	—	12	—	—	12		
		+25 °C		—	0.9	5	—	0.9	5		
		0 to +70 °C		—	—	6.5	—	—	6.5		
		TLC271AC		+25 °C	—	0.24	2	—	0.26	2	
		TLC271BC		0 to +70 °C	—	—	3	—	—	3	
α _{V_{I°}}	Average Temperature Coefficient of Input Offset Voltage		—	+25 to +70 °C	1.1			1			μV/°C
I _{I°}	Input Offset Current (Note 22)		V _° = V _{DD} /2, V _{IC} = V _{DD} /2	+25 °C	—	0.1	60	—	0.1	60	pA
				+70 °C	—	7	300	—	8	300	
I _{IB}	Input Bias Current (Note 22)		V _° = V _{DD} /2, V _{IC} = V _{DD} /2	+25 °C	—	0.6	60	—	0.7	60	pA
				+70 °C	—	40	600	—	50	600	
V _{ICR}	Common Mode Input Voltage (Note 23)		—	+25 °C	-0.2 to 4	-0.3 to 4.2	—	-0.2 to 9	-0.3 to 9.2	—	V
				0 to +70 °C	-0.2 to 3.5	—	—	-0.2 to 8.5	—	—	—
V _{°H}	High Level Output Voltage		V _{ID} = 100mV, R _L = 1MΩ	+25 °C	3.2	4.1	—	8	8.9	—	V
				0 °C	3	4.1	—	7.8	8.9	—	
				+70 °C	3	4.2	—	7.8	8.9	—	
V _{°L}	Low Level Output Voltage		V _{ID} = -100mV, I _{°L} = 0	+25 °C	—	0	50	—	0	50	mV
				0 °C	—	0	50	—	0	50	
				+70 °C	—	0	50	—	0	50	
A _{VD}	Large Signal Differential Voltage Gain		R _L = 1MΩ (Note 24)	+25 °C	50	520	—	50	870	—	V/mV
				0 °C	50	700	—	50	1030	—	
				+70 °C	50	380	—	50	660	—	
CMRR	Common Mode Rejection Ratio		V _{IC} = V _{ICRmin}	+25 °C	65	94	—	65	97	—	dB
				0 °C	60	95	—	60	97	—	
				+70 °C	60	95	—	60	97	—	
k _{SVR}	Supply Voltage Rejection Ratio (ΔV _{DD} /ΔV _{I°})		V _{DD} = 5V to 10V, V _° = 1.4V	+25 °C	70	97	—	70	97	—	dB
				0 °C	60	97	—	60	97	—	
				+70 °C	60	98	—	60	98	—	
I _{I(SEL)}	Input Current (BIAS SELECT)		V _{I(SEL)} = 0	+25 °C	—	65	—	—	95	—	nA
I _{DD}	Supply Current		V _° = V _{DD} /2, V _{IC} = V _{DD} /2, No load	+25 °C	—	10	17	—	14	23	μA
				0 °C	—	12	21	—	18	33	
				+70 °C	—	8	14	—	11	20	

- Notes: 22. The typical values of input bias current and input offset current below 5pA were calculated.
 23. This range also applies to each input individually.
 24. At V_{DD} = 5 V, V_° = 0.25 V to 2 V; at V_{DD} = 10 V, V_° = 1 V to 6 V.

Electrical Characteristics

Low bias mode			Conditions	T _A	TLC271I, TLC271AI, TLC271BI						Unit
Parameter					V _{DD} = 5V			V _{DD} = 10V			
					Min	Typ	Max	Min	Typ	Max	
V _{IO}	Input Offset Voltage	TLC271I	V _o = 1.4V, V _{IC} = 0V, R _S = 50Ω, R _L = 1MΩ	+25 °C	—	1.1	10	—	1.1	10	mV
				-40 to +85 °C	—	—	13	—	—	13	
		TLC271AI		+25 °C	—	0.9	5	—	0.9	5	
				-40 to +85 °C	—	—	7	—	—	7	
		TLC271BI		+25 °C	—	0.24	2	—	0.26	2	
				-40 to +85 °C	—	—	3.5	—	—	3.5	
α _{VI}	Average Temperature Coefficient of Input Offset Voltage			+25 to +85 °C	1.1			1			μV/°C
I _{IO}	Input Offset Current (Note 25)		V _o = V _{DD} /2, V _{IC} = V _{DD} /2	+25 °C	—	0.1	60	—	0.1	60	pA
				+85 °C	—	24	1000	—	26	1000	
I _{IB}	Input Bias Current (Note 25)		V _o = V _{DD} /2, V _{IC} = V _{DD} /2	+25 °C	—	0.6	60	—	0.7	60	pA
				+85 °C	—	200	2000	—	220	2000	
V _{ICR}	Common Mode Input Voltage (Note 26)		—	+25 °C	-0.2 to 4	-0.3 to 4.2	—	-0.2 to 9	-0.3 to 9.2	—	V
				-40 to +85 °C	-0.2 to 3.5	—	—	-0.2 to 8.5	—	—	V
V _{OH}	High Level Output Voltage		V _{ID} = 100mV, R _L = 1MΩ	+25 °C	3	4.1	—	8	8.9	—	V
				-40 °C	3	4.1	—	7.8	8.9	—	
				+85 °C	3	4.2	—	7.8	8.9	—	
V _{OL}	Low Level Output Voltage		V _{ID} = -100mV, I _L = 0	+25 °C	—	0	50	—	0	50	mV
				-40 °C	—	0	50	—	0	50	
				+85 °C	—	0	50	—	0	50	
A _{VD}	Large Signal Differential Voltage Gain		R _L = 1MΩ (Note 27)	+25 °C	50	520	—	50	870	—	V/mV
				-40 °C	50	900	—	50	1550	—	
				+85 °C	50	330	—	50	585	—	
CMRR	Common Mode Rejection Ratio		V _{IC} = V _{ICRmin}	+25 °C	65	94	—	65	97	—	dB
				-40 °C	60	95	—	60	97	—	
				+85 °C	60	95	—	60	98	—	
k _{SVR}	Supply Voltage Rejection Ratio (ΔV _{DD} /ΔV _{IO})		V _{DD} = 5V to 10V, V _o = 1.4V	+25 °C	70	97	—	70	97	—	dB
				-40 °C	60	97	—	60	97	—	
				+85 °C	60	98	—	60	98	—	
I _{I(SEL)}	Input Current (BIAS SELECT)		V _{I(SEL)} = 0	+25 °C	—	65	—	—	95	—	nA
I _{DD}	Supply Current		V _o = V _{DD} /2, V _{IC} = V _{DD} /2, No load	+25 °C	—	10	17	—	14	23	μA
				-40 °C	—	16	27	—	25	43	
				+85 °C	—	17	13	—	10	18	

Notes: 25. The typical values of input bias current and input offset current below 5pA were calculated.
 26. This range also applies to each input individually.
 27. At V_{DD} = 5 V, V_o = 0.25 V to 2 V; at V_{DD} = 10 V, V_o = 1 V to 6 V.

Electrical Characteristics

Low bias mode: $V_{DD} = 5V$								
Parameter		Conditions		T_A	TLC271C, TLC271AC, TLC271BC			Unit
					Min	Typ	Max	
SR	Slew Rate at Unity Gain	$R_L = 1M\Omega$, $C_L = 20pF$ See Figure 92	$V_{I(PP)} = 1V$	+25°C	—	0.03	—	V/ μ s
				0°C	—	0.04	—	
				+70°C	—	0.03	—	
			$V_{I(PP)} = 2.5V$	+25°C	—	0.03	—	
				0°C	—	0.03	—	
				+70°C	—	0.02	—	
V_n	Equivalent Input Noise Voltage	$F = 1kHz$, $R_S = 20\Omega$ See Figure 93		+25°C	—	68	—	nV/ \sqrt{Hz}
B^*M	Maximum Output Swing Bandwidth	$V^* = V^*_H$, $C_L = 20pF$, $R_L = 1M\Omega$ See Figure 92	+25°C	—	5	—	kHz	
			0°C	—	6	—		
			+70°C	—	4.5	—		
B_1	Unity Gain Bandwidth	$V_I = 10mV$, $C_L = 20pF$ See Figure 94	+25°C	—	85	—	MHz	
			0°C	—	100	—		
			+70°C	—	65	—		
ϕ_m	Phase Margin	$F = B_1$, $V_I = 10mV$, $C_L = 20pF$ See Figure 94	+25°C	—	34°	—	—	
			0°C	—	36°	—		
			+70°C	—	30°	—		
Low bias mode: $V_{DD} = 10V$								
Parameter		Conditions		T_A	TLC271C, TLC271AC, TLC271BC			Unit
					Min	Typ	Max	
SR	Slew Rate at Unity Gain	$R_L = 1M\Omega$, $C_L = 20pF$ See Figure 92	$V_{I(PP)} = 1V$	+25°C	—	0.05	—	V/ μ s
				0°C	—	0.05	—	
				+70°C	—	0.04	—	
			$V_{I(PP)} = 5.5V$	+25°C	—	0.04	—	
				0°C	—	0.05	—	
				+70°C	—	0.04	—	
V_n	Equivalent Input Noise Voltage	$F = 1kHz$, $R_S = 20\Omega$ See Figure 93		+25°C	—	68	—	nV/ \sqrt{Hz}
B^*M	Maximum Output Swing Bandwidth	$V^* = V^*_H$, $C_L = 20pF$, $R_L = 1M\Omega$ See Figure 92	+25°C	—	1	—	kHz	
			0°C	—	1.3	—		
			+70°C	—	0.9	—		
B_1	Unity Gain Bandwidth	$V_I = 10mV$, $C_L = 20pF$ See Figure 94	+25°C	—	110	—	MHz	
			0°C	—	125	—		
			+70°C	—	90	—		
ϕ_m	Phase Margin	$F = B_1$, $V_I = 10mV$, $C_L = 20pF$ See Figure 94	+25°C	—	38°	—	—	
			0°C	—	40°	—		
			+70°C	—	34°	—		

Electrical Characteristics

Low bias mode: $V_{DD} = 5V$								
Parameter		Conditions		T_A	TLC271I, TLC271AI, TLC271BI			Unit
					Min	Typ	Max	
SR	Slew Rate at Unity Gain	$R_L = 1M\Omega$, $C_L = 20pF$ See Figure 92	$V_{I(PP)} = 1V$	+25 °C	—	0.03	—	V/ μ s
				-40 °C	—	0.04	—	
				+85 °C	—	0.03	—	
			$V_{I(PP)} = 2.5V$	+25 °C	—	0.03	—	
				-40 °C	—	0.04	—	
				+85 °C	—	0.02	—	
V_n	Equivalent Input Noise Voltage	$F = 1kHz$, $R_S = 20\Omega$ See Figure 93	+25 °C	—	68	—	nV/ \sqrt{Hz}	
B_M	Maximum Output Swing Bandwidth	$V_o = V_{OH}$, $C_L = 20pF$, $R_L = 1M\Omega$ See Figure 92	+25 °C	—	5	—	kHz	
			-40 °C	—	7	—		
			+85 °C	—	4	—		
B_1	Unity Gain Bandwidth	$V_I = 10mV$, $C_L = 20pF$ See Figure 94	+25 °C	—	85	—	MHz	
			-40 °C	—	130	—		
			+85 °C	—	55	—		
ϕ_m	Phase Margin	$F = B_1$, $V_I = 10mV$, $C_L = 20pF$ See Figure 94	+25 °C	—	34°	—	—	
			-40 °C	—	38°	—		
			+85 °C	—	28°	—		
Low bias mode: $V_{DD} = 10V$								
Parameter		Conditions		T_A	TLC271I, TLC271AI, TLC271BI			Unit
					Min	Typ	Max	
SR	Slew Rate at Unity Gain	$R_L = 1M\Omega$, $C_L = 20pF$ See Figure 92	$V_{I(PP)} = 1V$	+25 °C	—	0.05	—	V/ μ s
				-40 °C	—	0.06	—	
				+85 °C	—	0.03	—	
			$V_{I(PP)} = 5.5V$	+25 °C	—	0.04	—	
				-40 °C	—	0.05	—	
				+85 °C	—	0.03	—	
V_n	Equivalent Input Noise Voltage	$F = 1kHz$, $R_S = 20\Omega$ See Figure 93	+25 °C	—	68	—	nV/ \sqrt{Hz}	
B_M	Maximum Output Swing Bandwidth	$V_o = V_{OH}$, $C_L = 20pF$, $R_L = 1M\Omega$ See Figure 92	+25 °C	—	1	—	kHz	
			-40 °C	—	1.4	—		
			+85 °C	—	0.8	—		
B_1	Unity Gain Bandwidth	$V_I = 10mV$, $C_L = 20pF$ See Figure 94	+25 °C	—	110	—	MHz	
			-40 °C	—	155	—		
			+85 °C	—	80	—		
ϕ_m	Phase Margin	$F = B_1$, $V_I = 10mV$, $C_L = 20pF$ See Figure 94	+25 °C	—	38°	—	—	
			-40 °C	—	42°	—		
			+85 °C	—	32°	—		

Typical Performance Characteristics Table Index of Graphs

			Figure		
			High Bias Mode	Medium Bias Mode	Low Bias Mode
V_{I^o}	Input Offset Voltage	Distribution	1,2	31,32	61,62
V_{OH}	High Level Output Voltage	vs. High Level Output Current	3,4	33,34	63,64
		vs. Supply Voltage	5	35	65
		vs. Free Air Temperature	6	36	66
V_{OL}	Low Level Output Voltage	vs. Common Mode Input Voltage	7,8	37,38	67,68
		vs. Differential Input Voltage	9	39	69
		vs. Free Air Temperature	10	40	70
		vs. Low Level Output Current	11,12	41,42	71,72
A_{VD}	Large Signal Differential Voltage Gain	vs. Supply Voltage	13	43	73
		vs. Free Air Temperature	14	44	74
I_{IB}	Input Bias Current	vs. Free Air Temperature	15	45	75
I_{I^o}	Input Offset Current	vs. Free Air Temperature	15	45	75
V_{IC}	Common Mode Input Voltage	vs. Supply Voltage	16	46	76
I_{DD}	Supply Current	vs. Supply Voltage	17	47	77
		vs. Free Air Temperature	18	48	78
SR	Slew Rate	vs. Supply Voltage	19	49	79
		vs. Free Air Temperature	20	50	80
I_{sel}	Bias Select Current	vs. Supply Voltage	21	51	81
$V_{o(PP)}$	Maximum Peak to Peak Output Voltage	vs. Frequency	22	52	82
B_1	Unity Gain Bandwidth	vs. Free Air Temperature	23	53	83
		vs. Supply Voltage	24	54	84
A_{VD}	Large Signal Differential Voltage Gain	vs. Frequency	29,30	59,60	89,90
ϕ_m	Phase Margin	vs. Supply Voltage	25	55	85
		vs. Free Air Temperature	26	56	86
		vs. Capacitive Load	27	57	87
V_n	Equivalent Input Noise Voltage	vs. Frequency	28	58	88
ϕ_{shift}	Phase Shift	vs. Frequency	29,30	59,60	89,90

Typical Performance Characteristics High Bias Mode

New Product

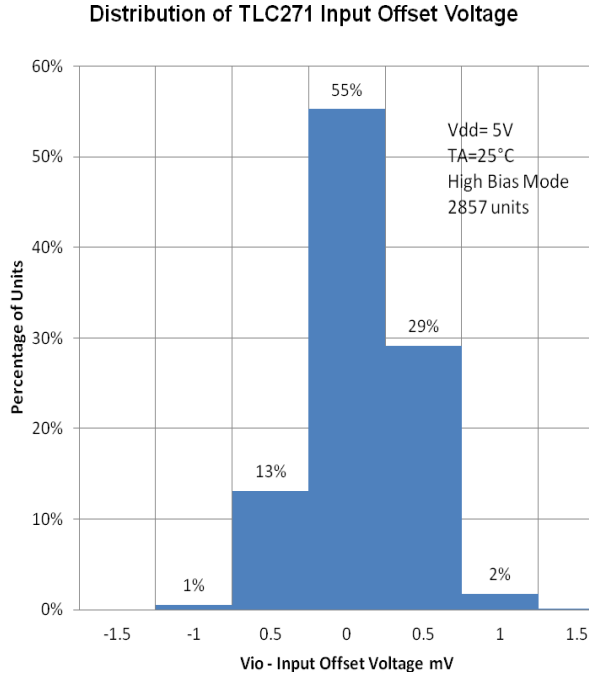

Figure 1

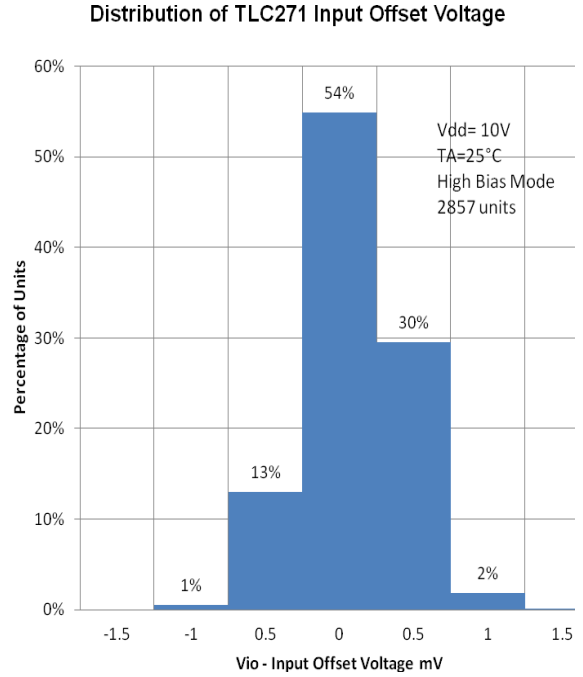

Figure 2

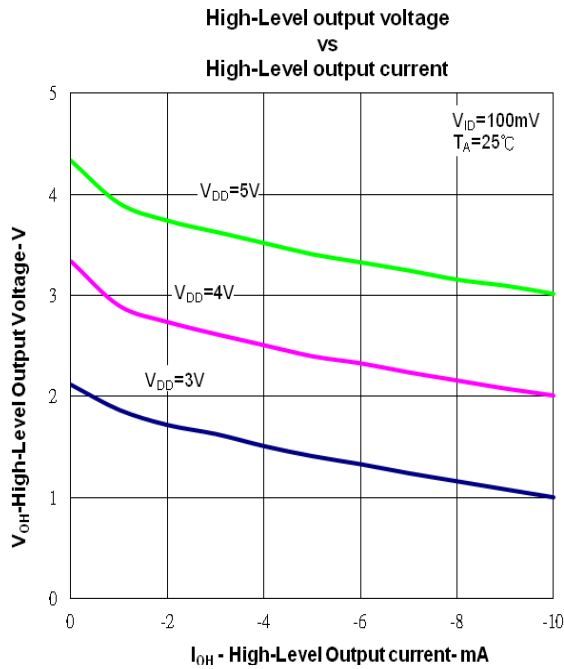

Figure 3

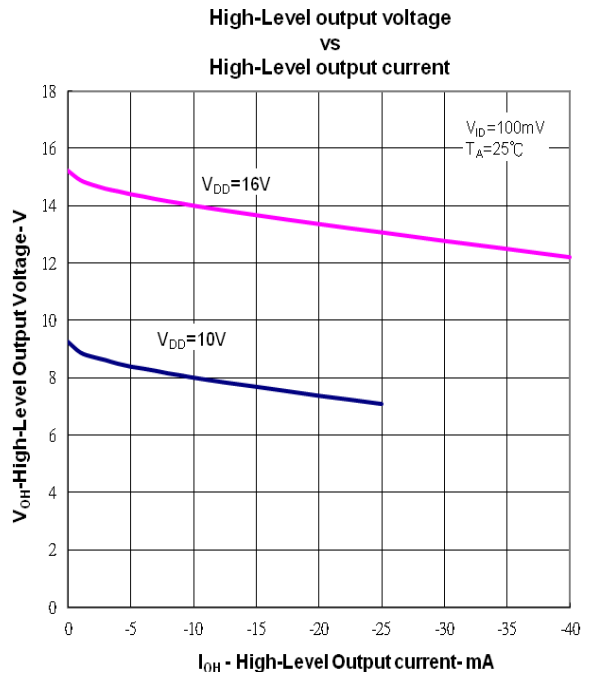

Figure 4

Typical Performance Characteristics High Bias Mode

High-Level output voltage
vs
Supply Voltage

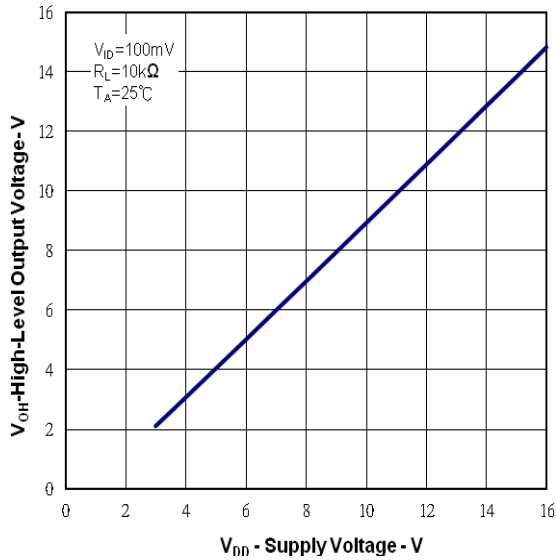

Figure 5

High-Level output voltage
vs
Free Air Temperature

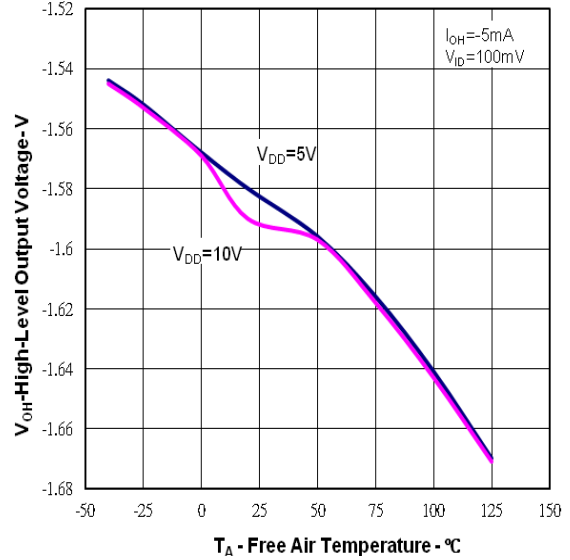

Figure 6

Low-level output voltage
vs
common-mode input voltage

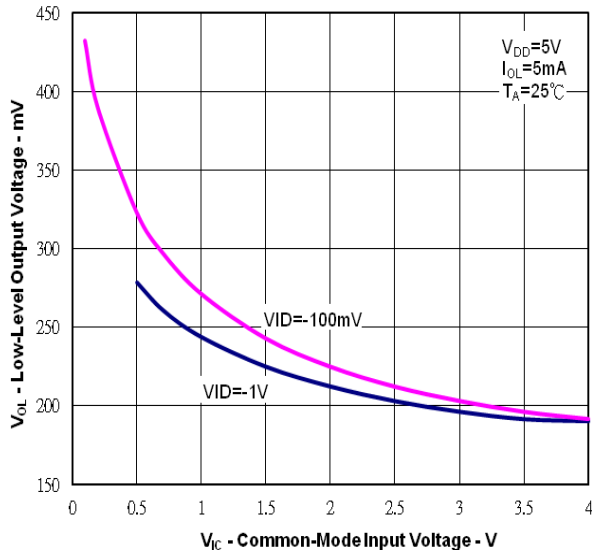

Figure 7

Low-level output voltage
vs
common-mode input voltage

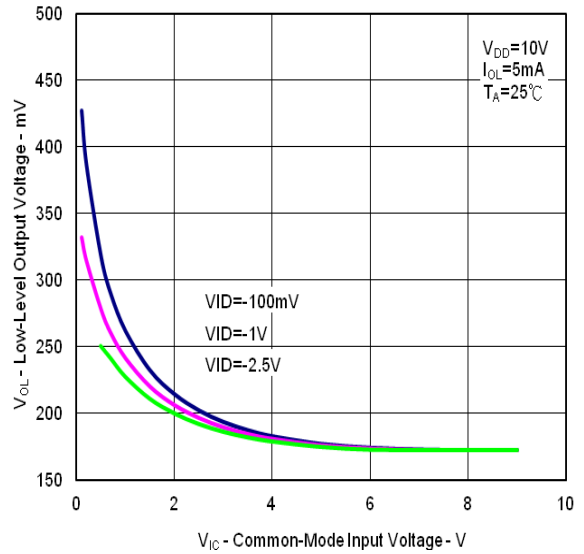

Figure 8

New Product

Typical Performance Characteristics High Bias Mode

Low-level output voltage
vs
Differential input voltage

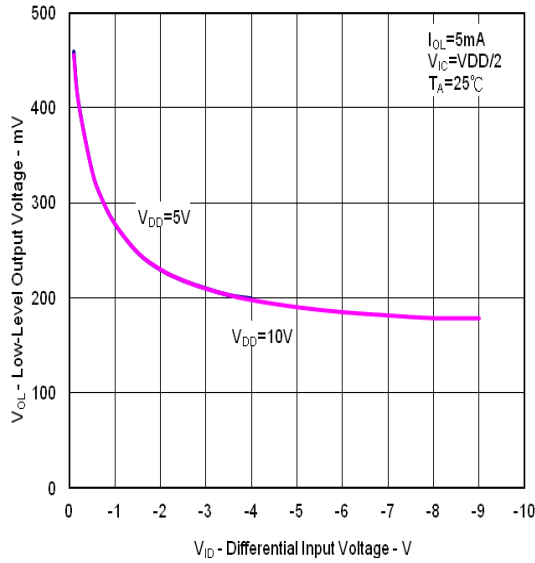

Figure 9

Low-level output voltage
vs
Free-Air temperature

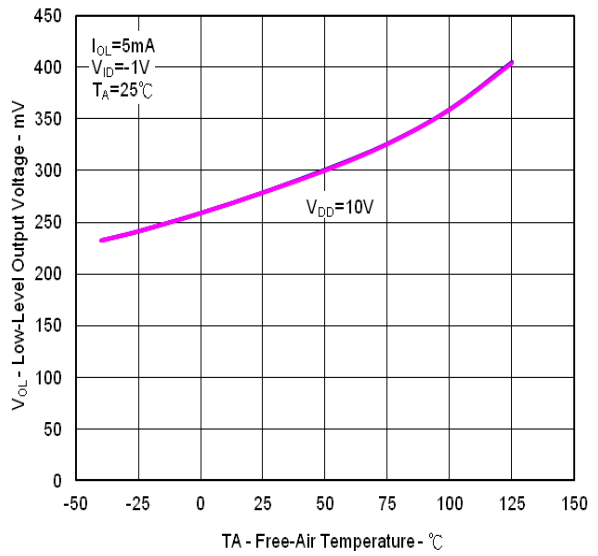

Figure 10

Low-level output voltage
vs
Low-level output current

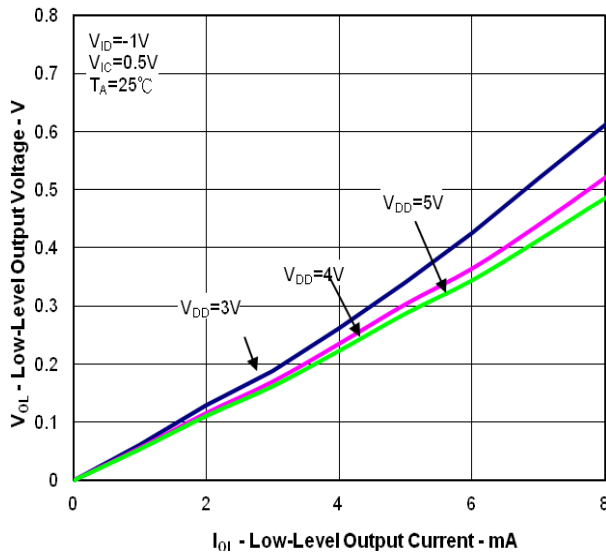

Figure 11

Low-level output voltage
vs
Low-level output current

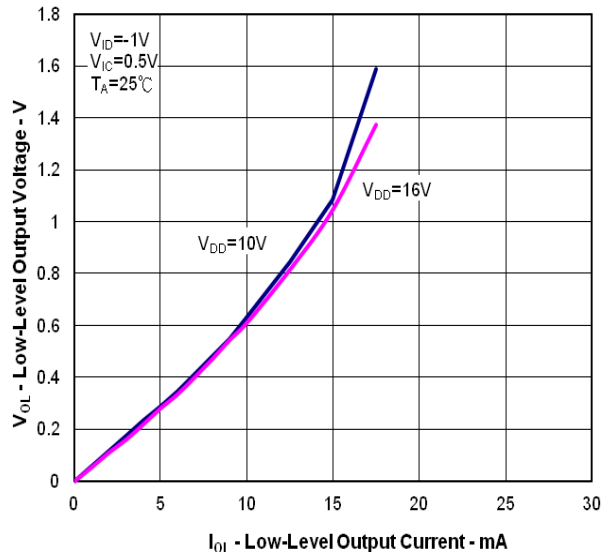

Figure 12

Typical Performance Characteristics High Bias Mode

New Product

Large-Signal Differential Voltage Amplification
vs
Supply Voltage

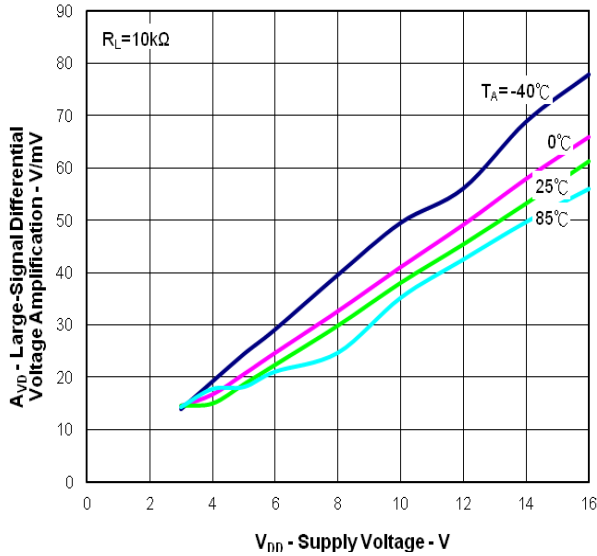

Figure 13

Large-Signal Differential Voltage Amplification
vs
Free-Air Temperature

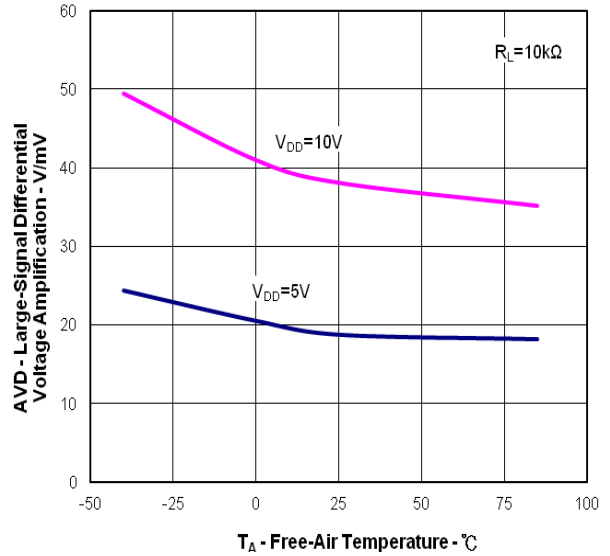

Figure 14

Input Bias Current and Input Offset Current
vs
Free-Air Temperature

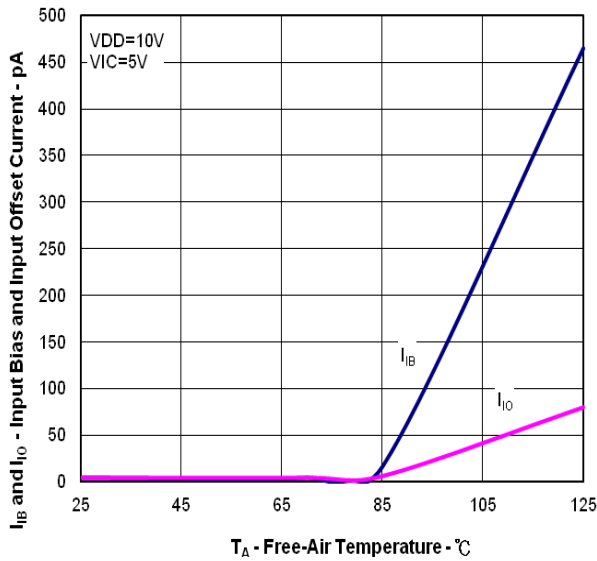

Figure 15

Common-mode input voltage
(positive limit)
vs
Supply Voltage

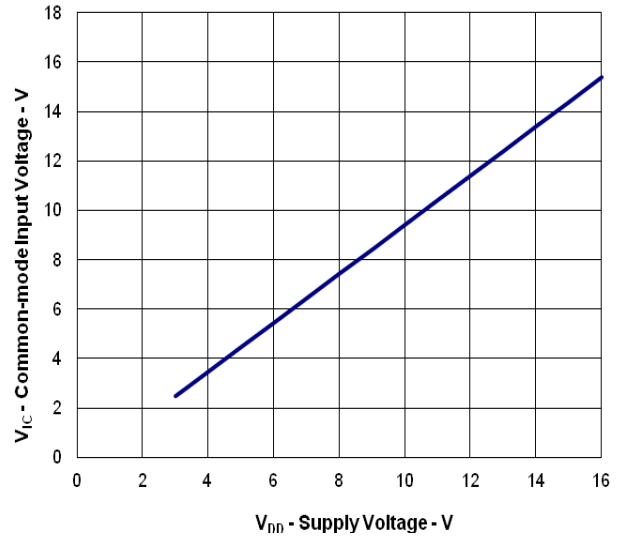

Figure 16

Typical Performance Characteristics High Bias Mode

New Product

Supply current
vs
Supply Voltage

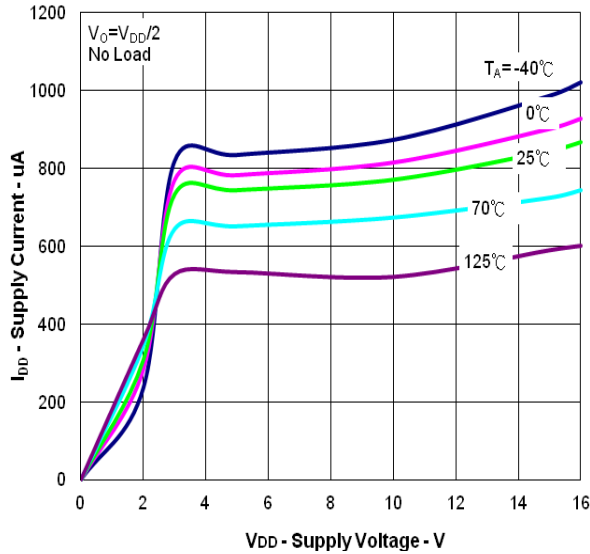

Figure 17

Supply current
vs
Free-Air Temperature

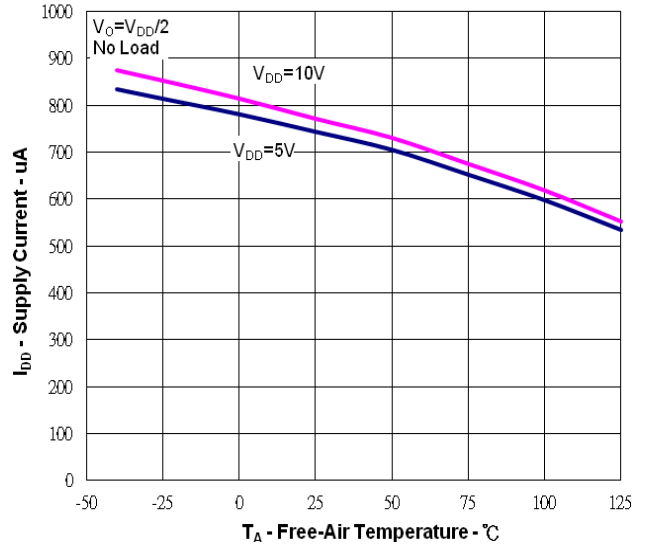

Figure 18

Slew Rate
vs
Supply Voltage

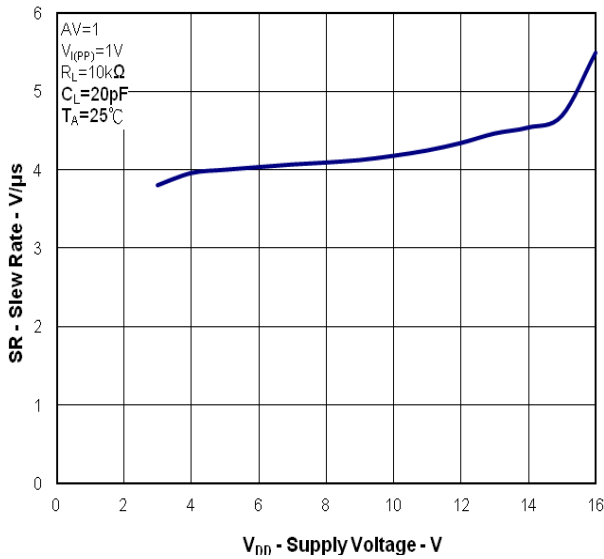

Figure 19

Slew rate
vs
Free-Air Temperature

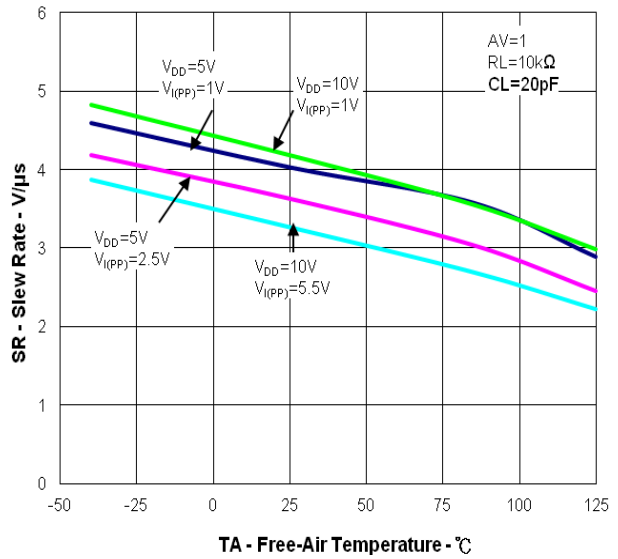
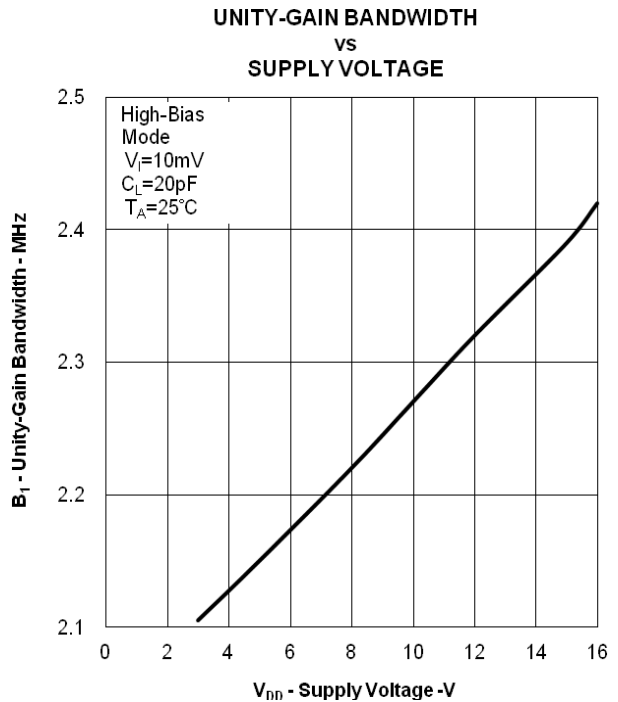
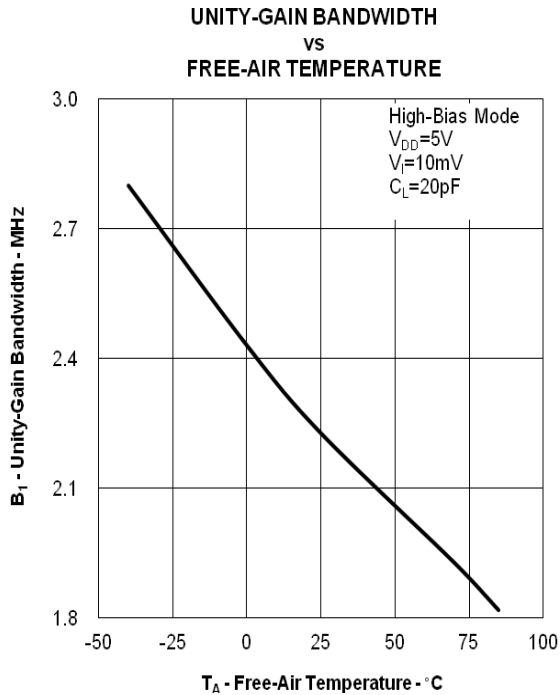
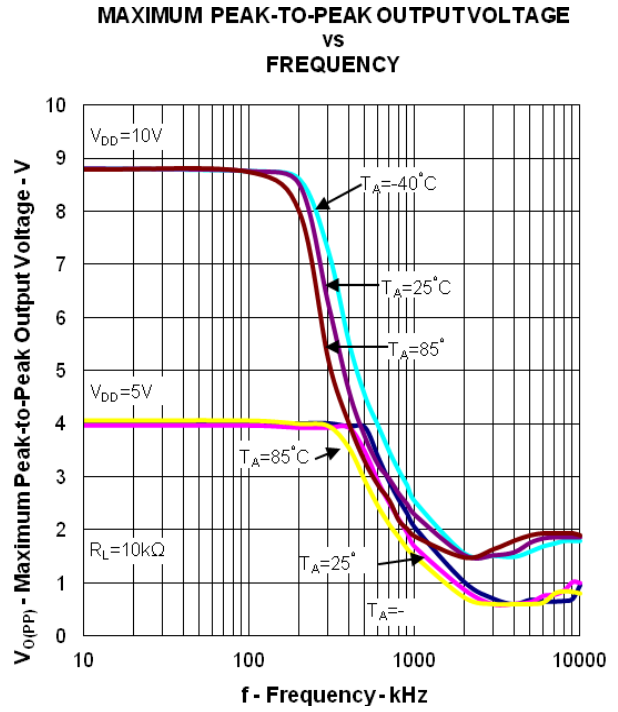
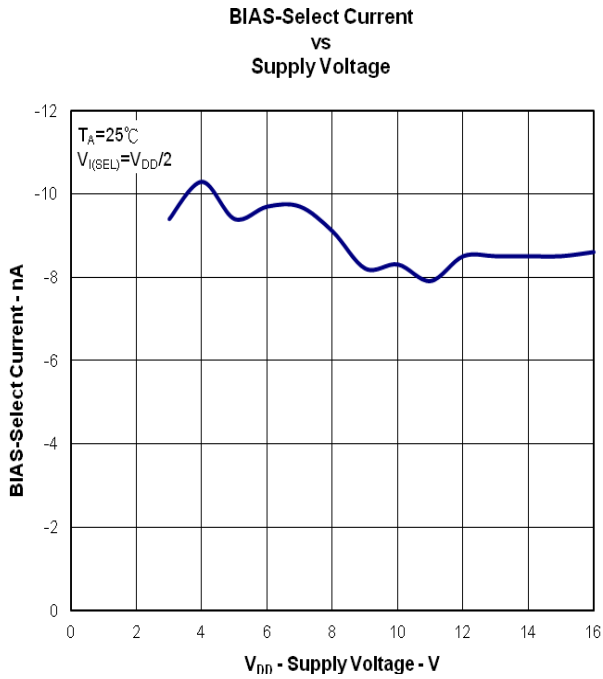

Figure 20

Typical Performance Characteristics High Bias Mode

New Product



Typical Performance Characteristics High Bias Mode

New Product

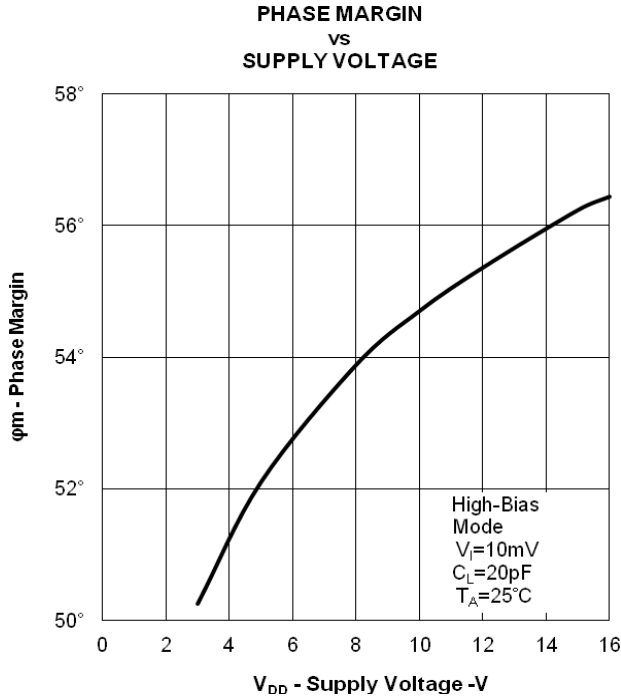

Figure 25

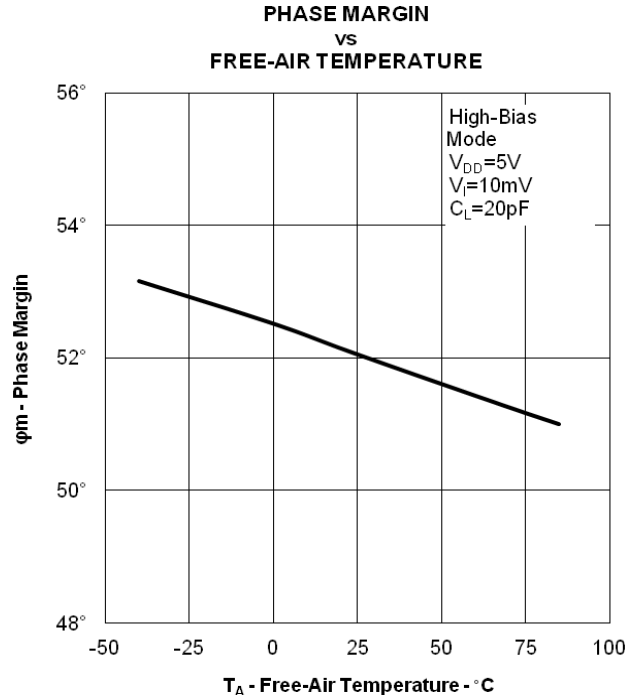

Figure 26

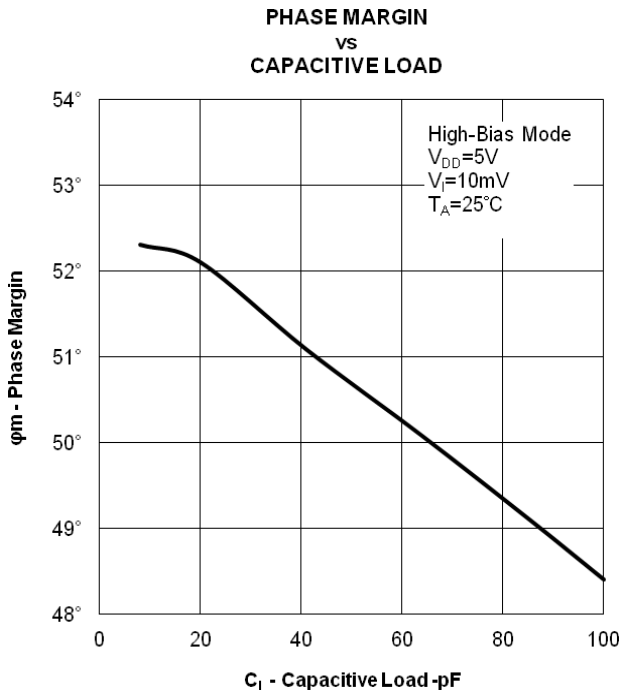

Figure 27

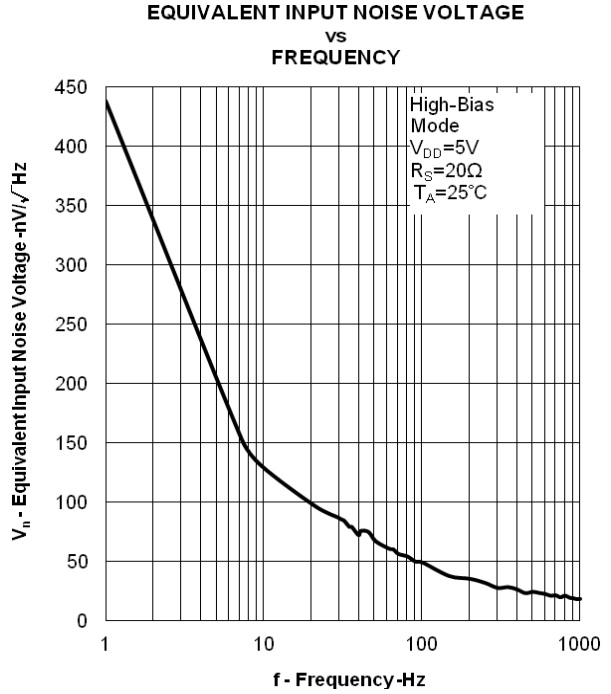

Figure 28

Typical Performance Characteristics High Bias Mode

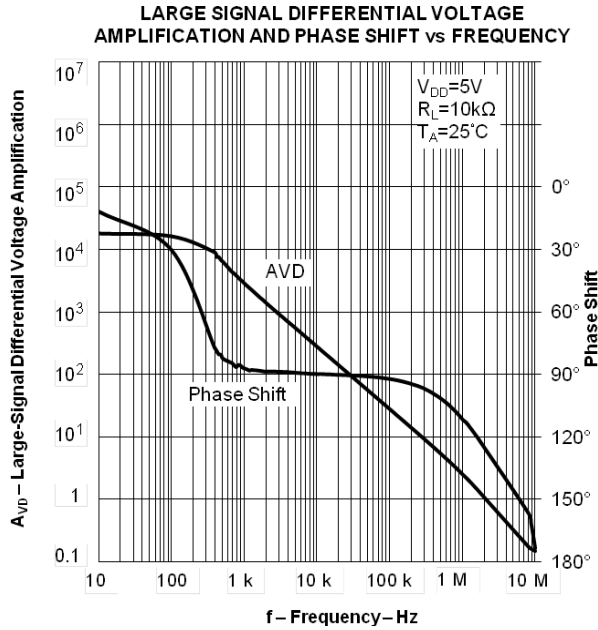

Figure 29

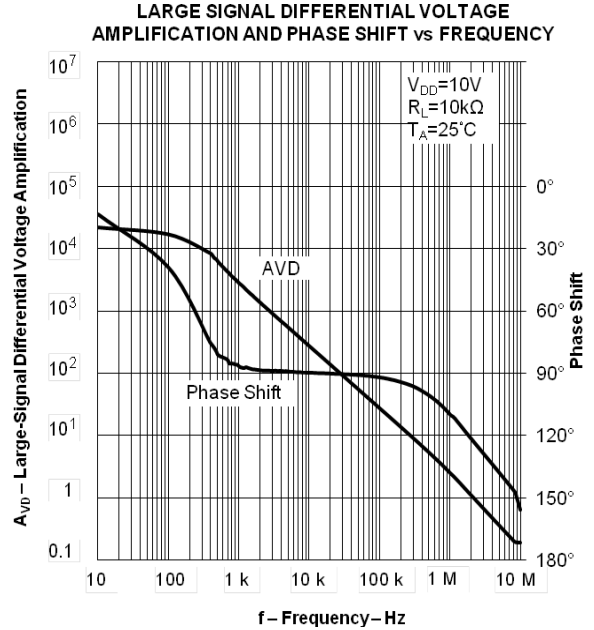

Figure 30

Typical Performance Characteristics Medium Bias Mode

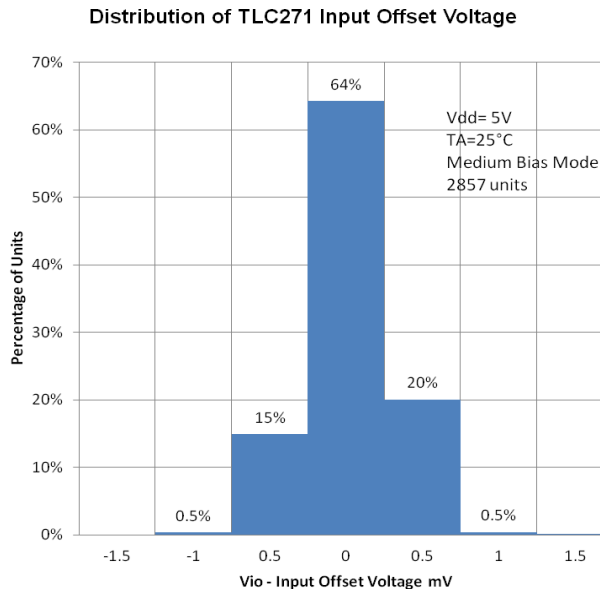

Figure 31

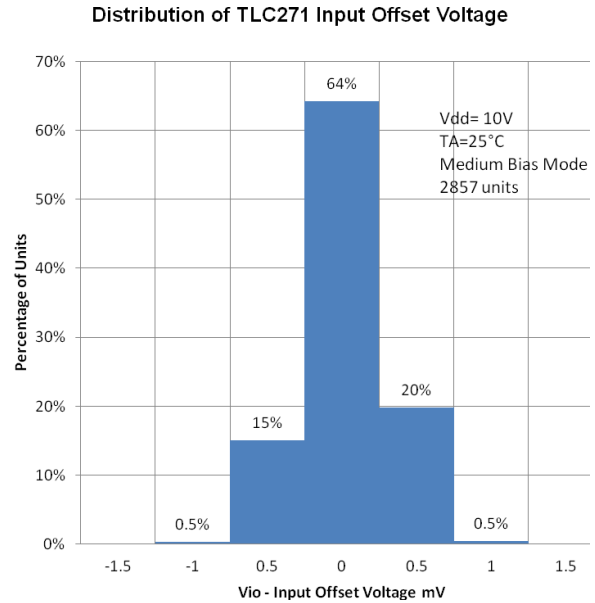
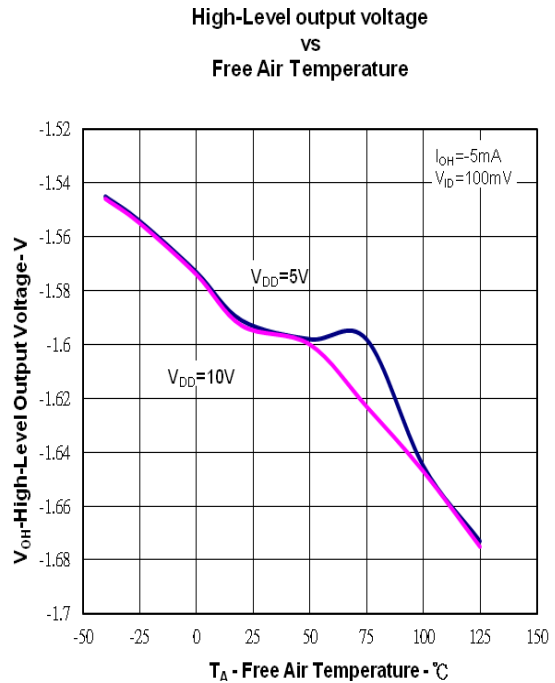
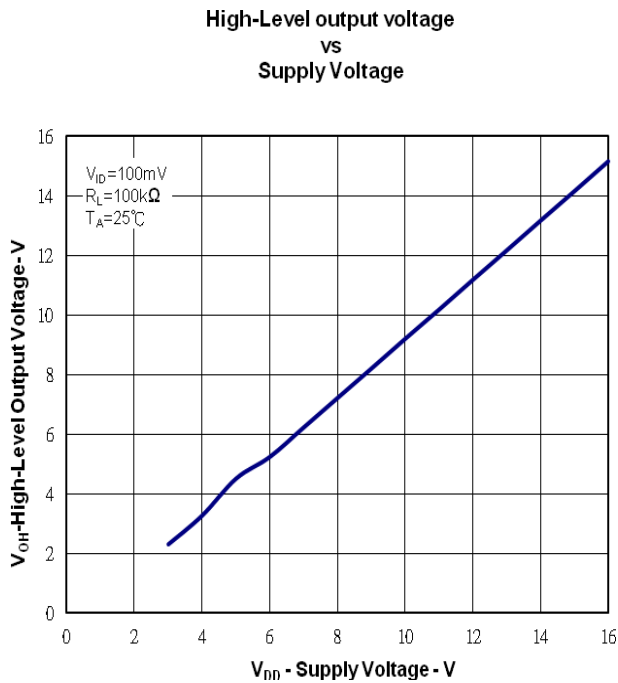
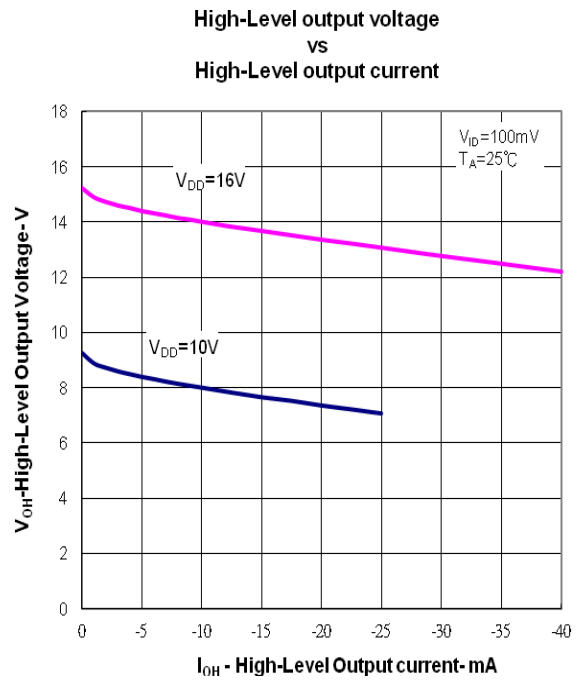
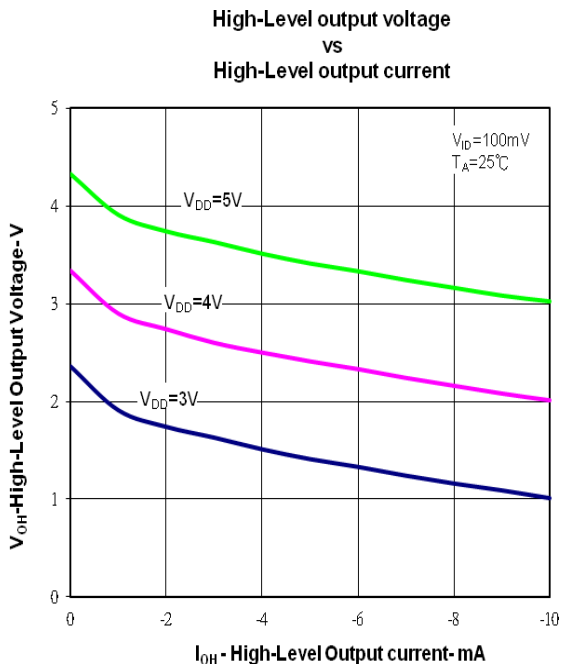

Figure 32

Typical Performance Characteristics Medium Bias Mode

New Product



Typical Performance Characteristics Medium Bias Mode

Low-level output voltage
vs
common-mode input voltage

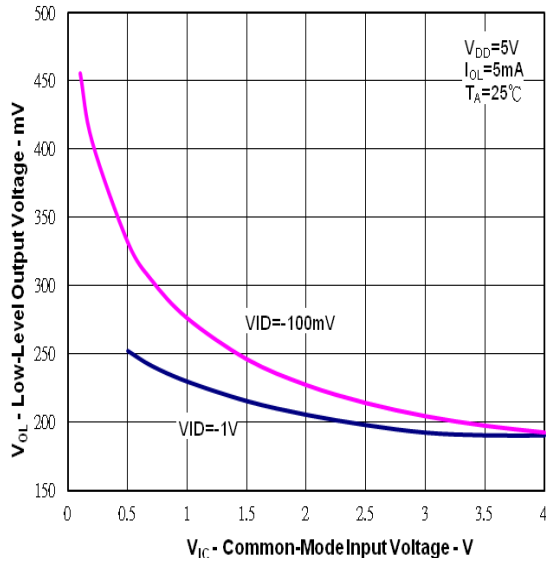

Figure 37

Low-level output voltage
vs
common-mode input voltage

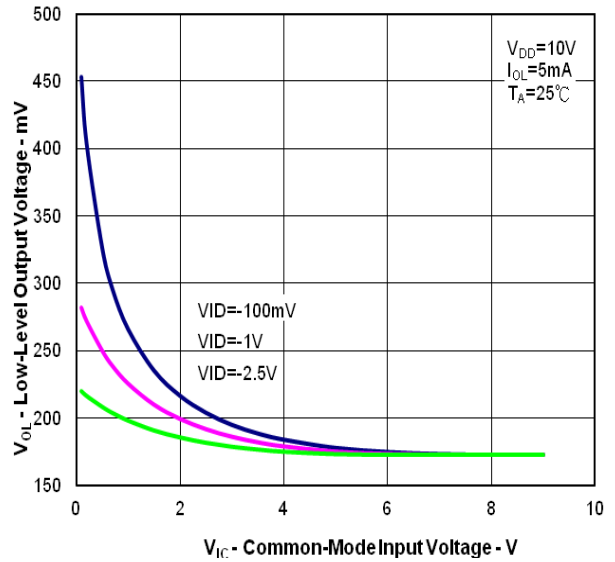

Figure 38

Low-level output voltage
vs
Differential input voltage

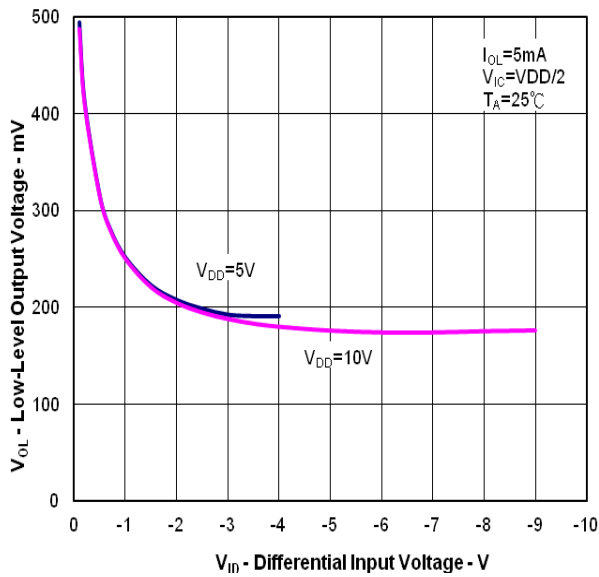

Figure 39

Low-level output voltage
vs
Free-Air temperature

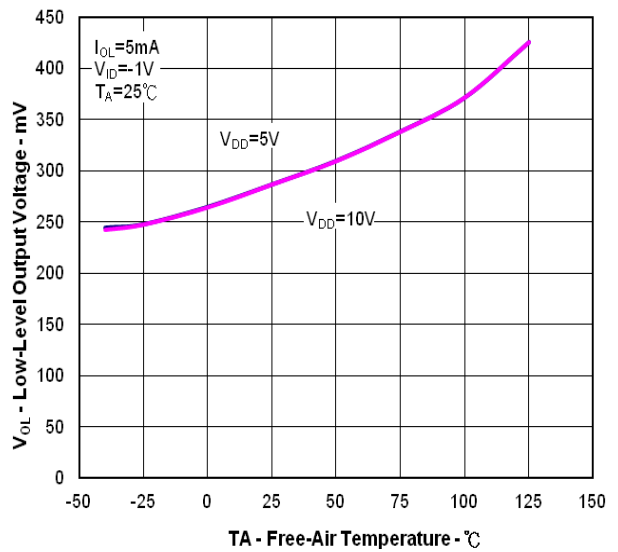

Figure 40

New Product

Typical Performance Characteristics Medium Bias Mode

Low-level output voltage
vs
Low-level output current

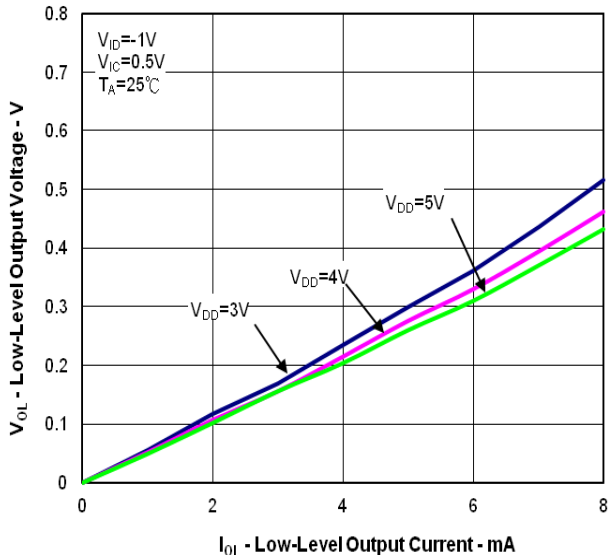

Figure 41

Low-level output voltage
vs
Low-level output current

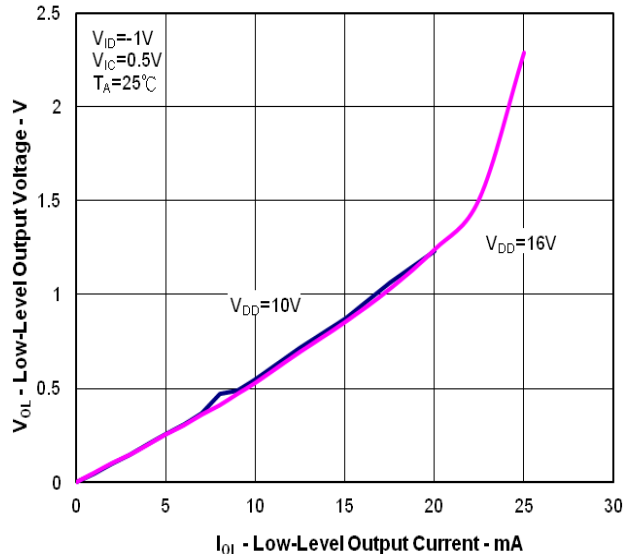

Figure 42

Large-Signal Differential Voltage Amplification
vs
Supply Voltage

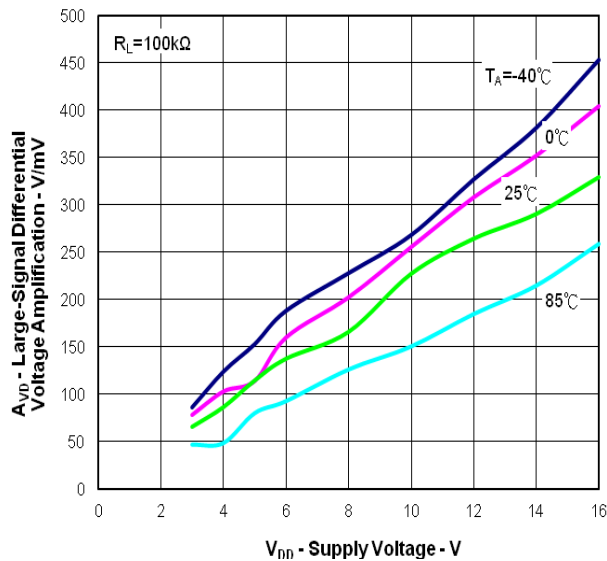

Figure 43

Large-Signal Differential Voltage Amplification
vs
Free-Air Temperature

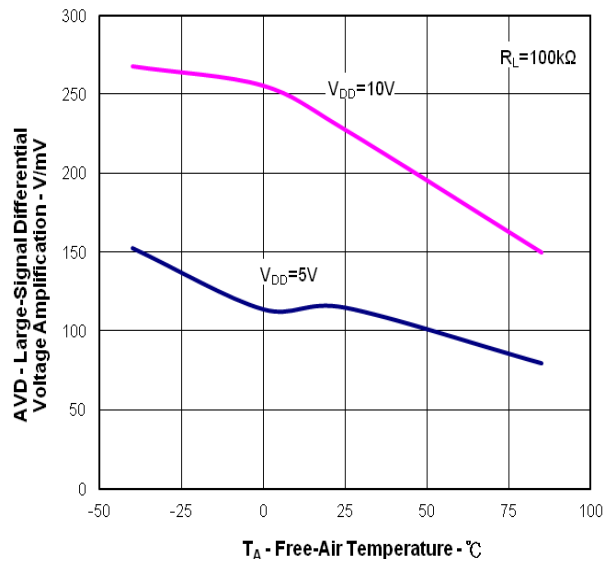

Figure 44

New Product

Typical Performance Characteristics Medium Bias Mode

New Product

Input Bias Current and Input Offset Current vs Free-Air Temperature

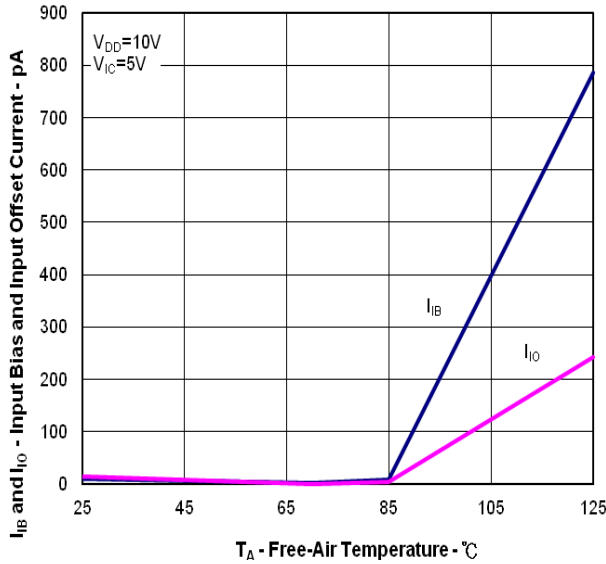

Figure 45

Common-mode input voltage (positive limit) vs Supply Voltage

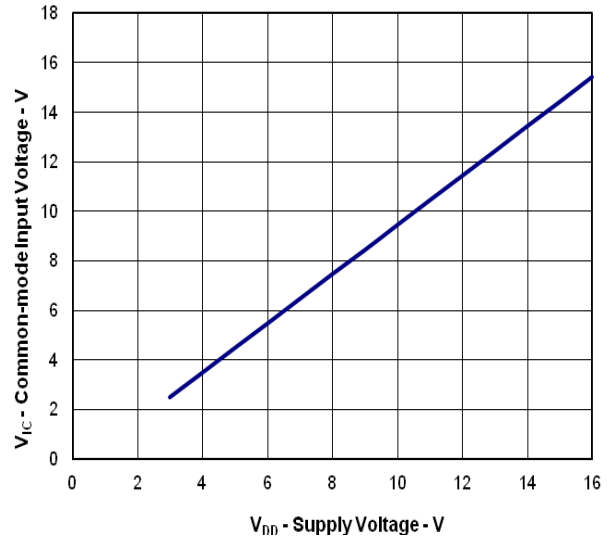

Figure 46

Supply current vs Supply Voltage

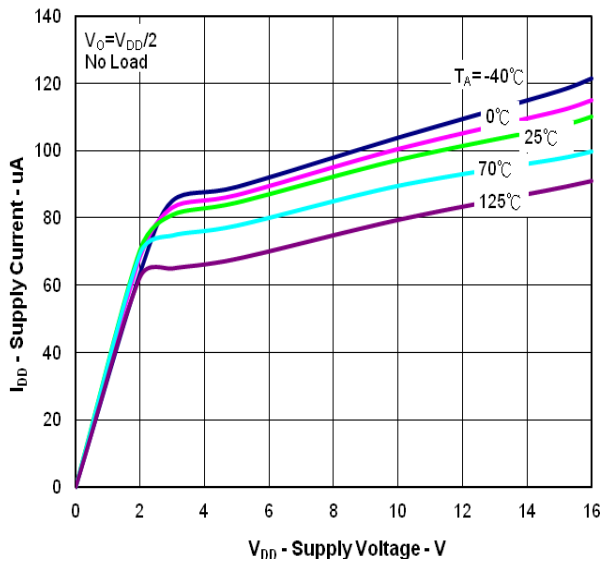

Figure 47

Supply current vs Free-Air Temperature

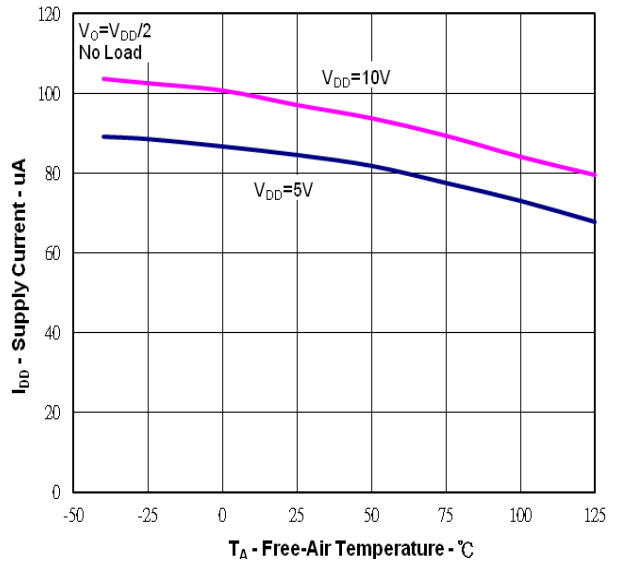

Figure 48

Typical Performance Characteristics Medium Bias Mode

New Product

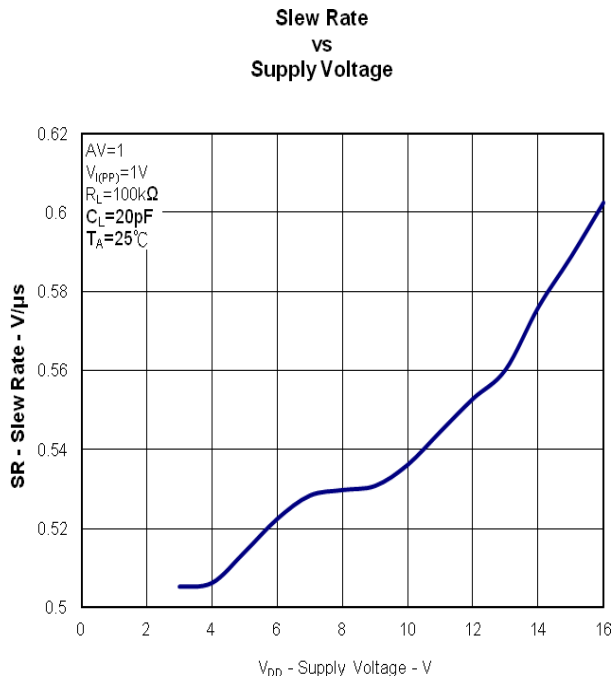

Figure 49

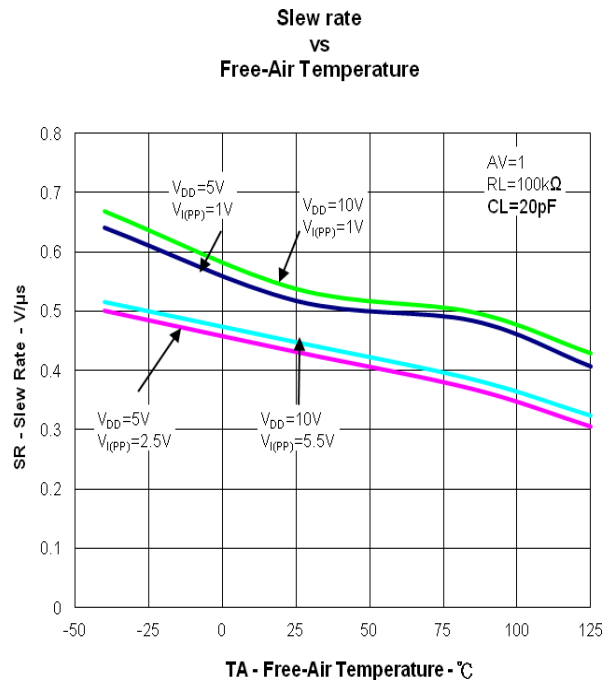

Figure 50

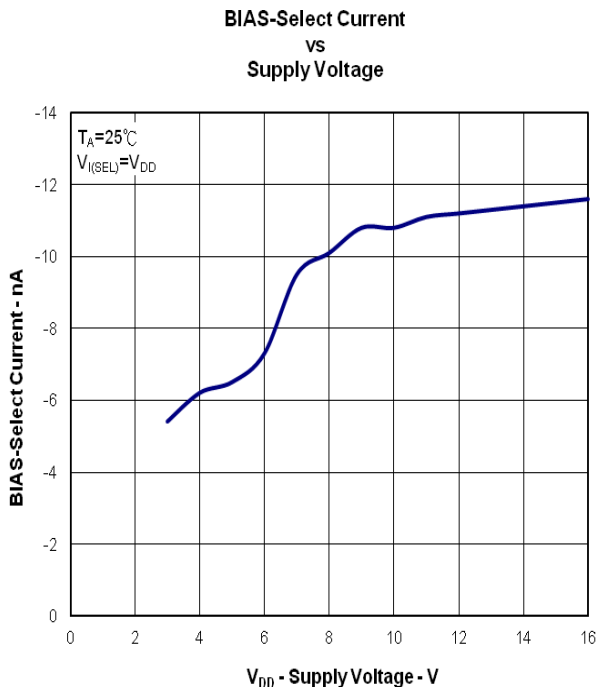

Figure 51

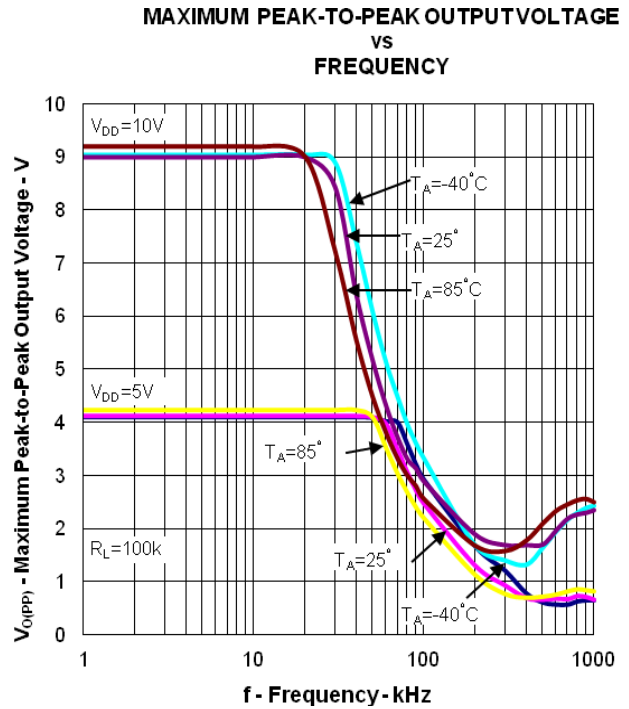

Figure 52

Typical Performance Characteristics Medium Bias Mode

New Product

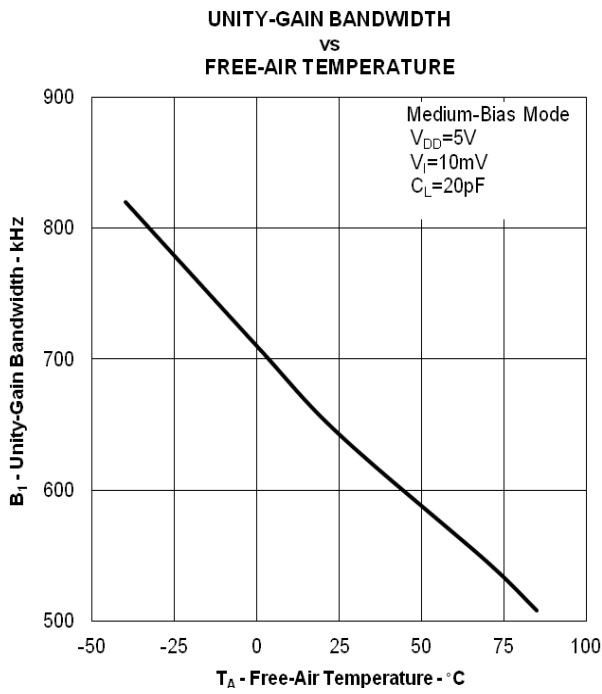

Figure 53

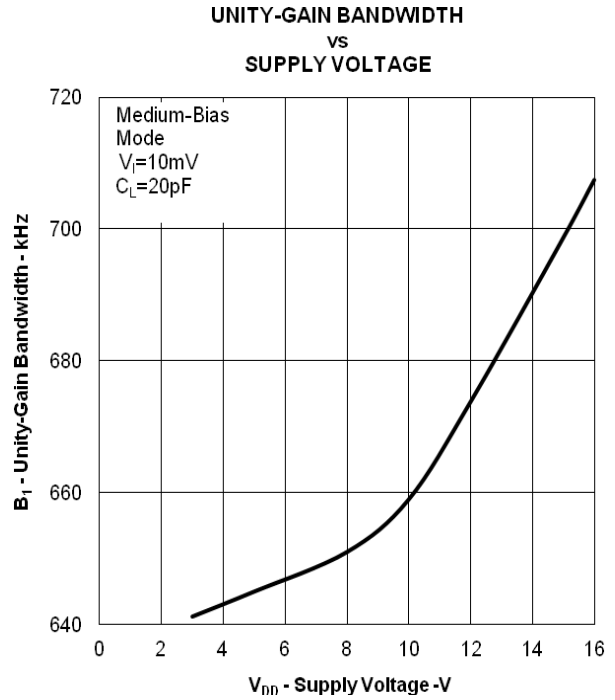

Figure 54

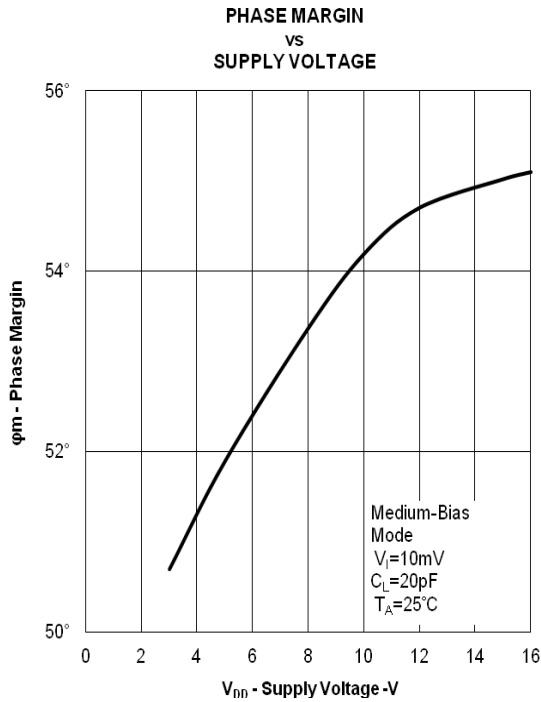

Figure 55

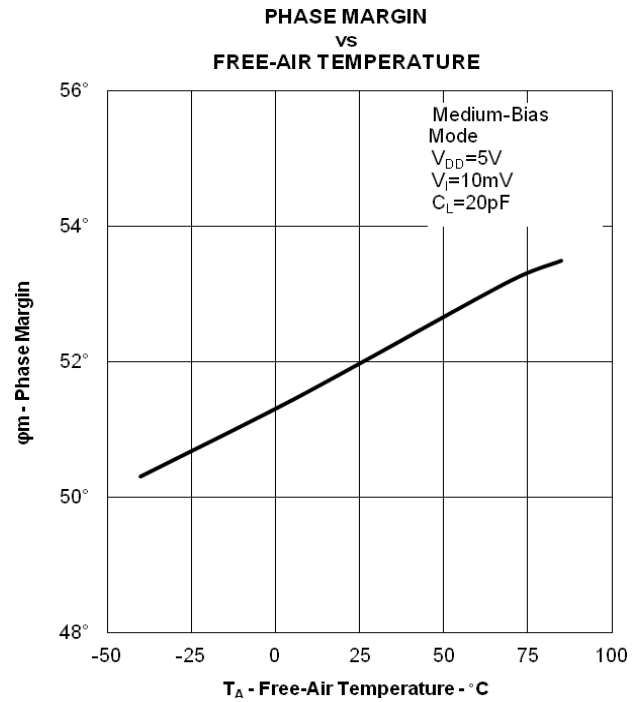

Figure 56

Typical Performance Characteristics Medium Bias Mode

New Product

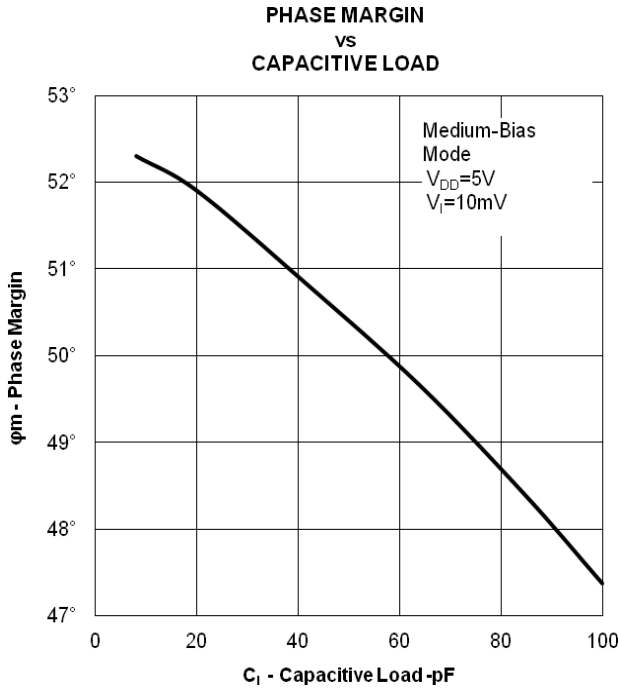

Figure 57

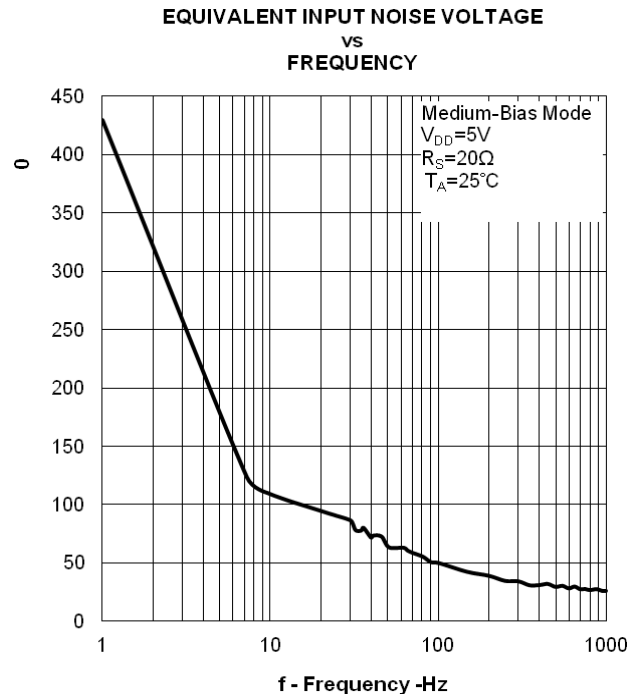

Figure 58

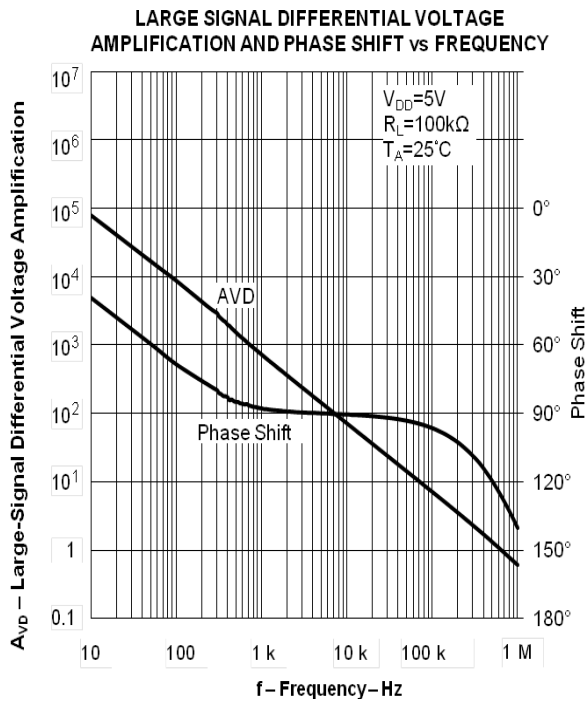

Figure 59

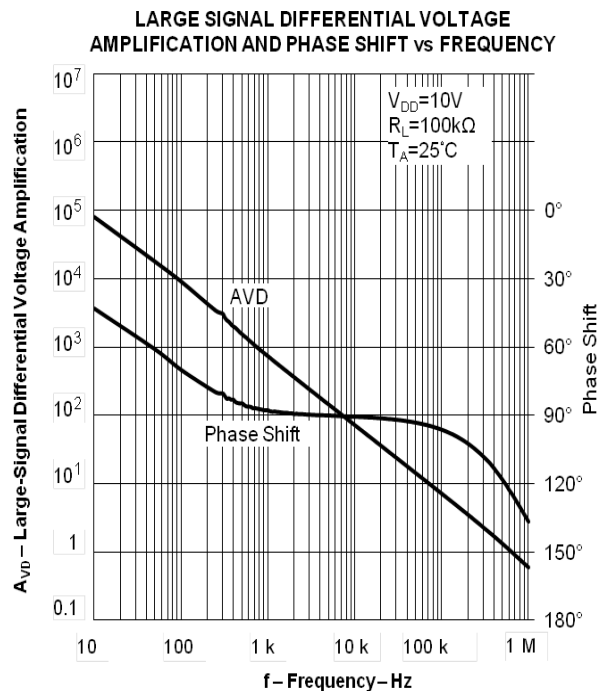

Figure 60

Typical Performance Characteristics Low Bias Mode

New Product

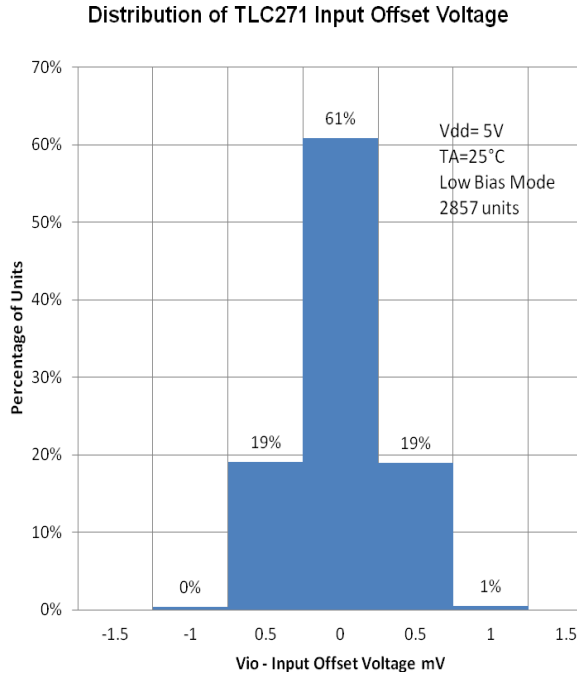

Figure 61

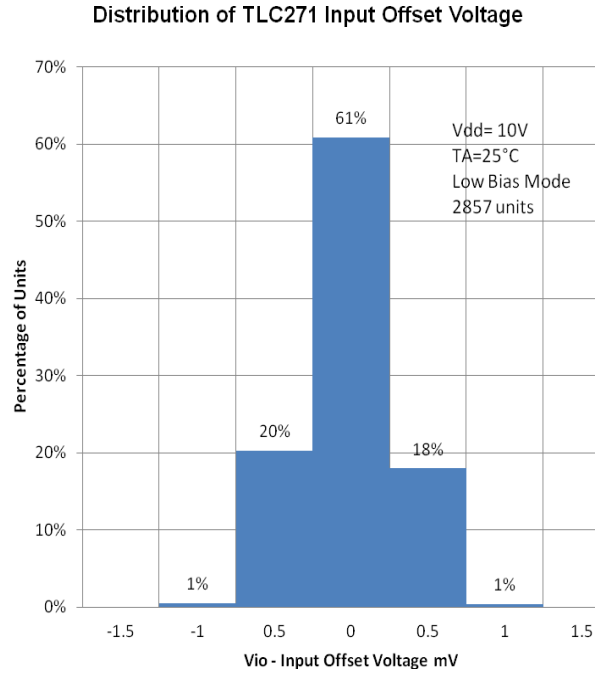

Figure 62

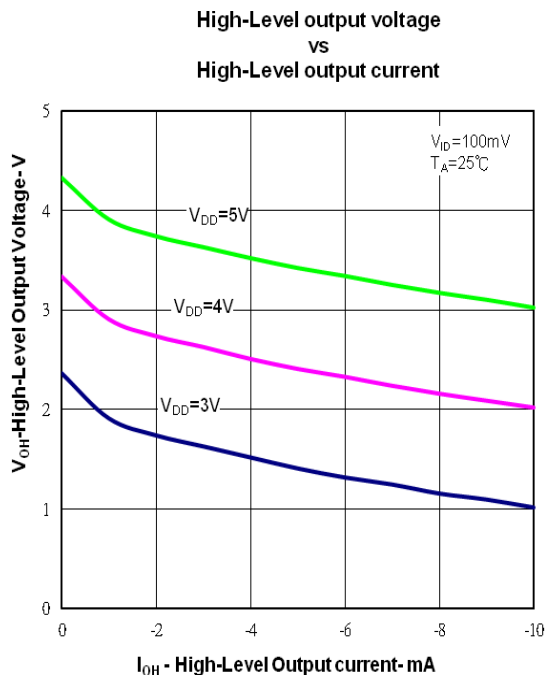

Figure 63

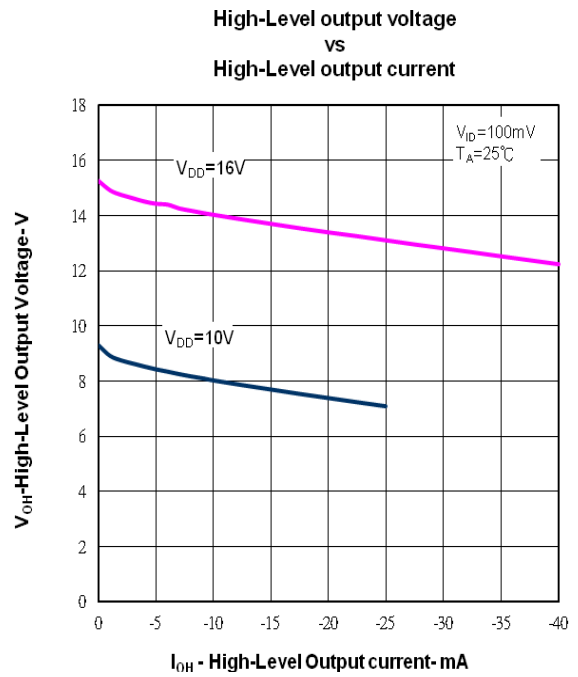

Figure 64

Typical Performance Characteristics Low Bias Mode

High-Level output voltage
vs
Supply Voltage

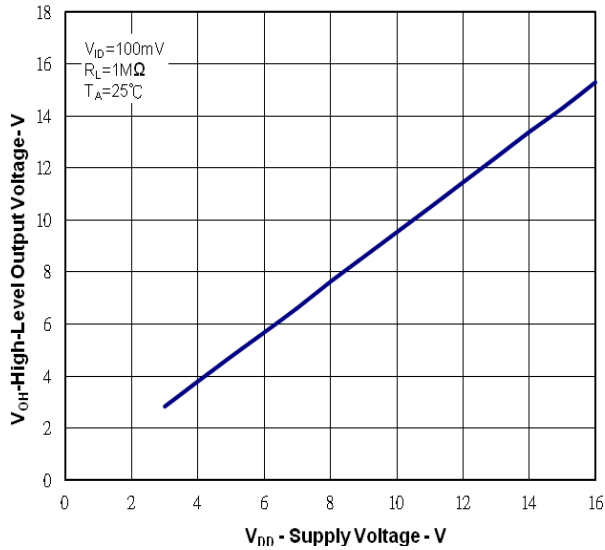

Figure 65

High-Level output voltage
vs
Free Air Temperature

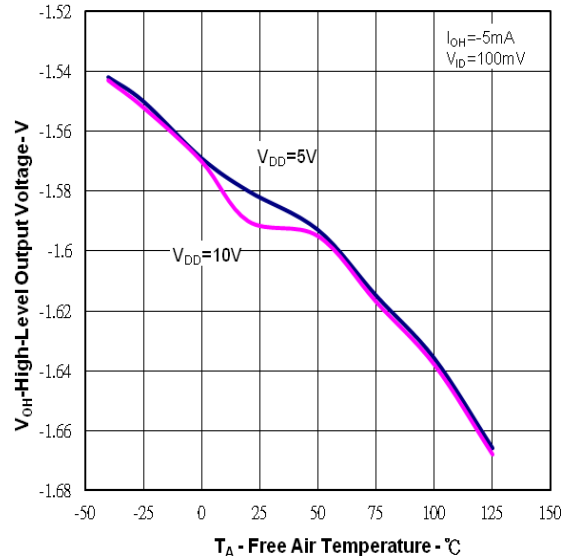

Figure 66

Low-level output voltage
vs
common-mode input voltage

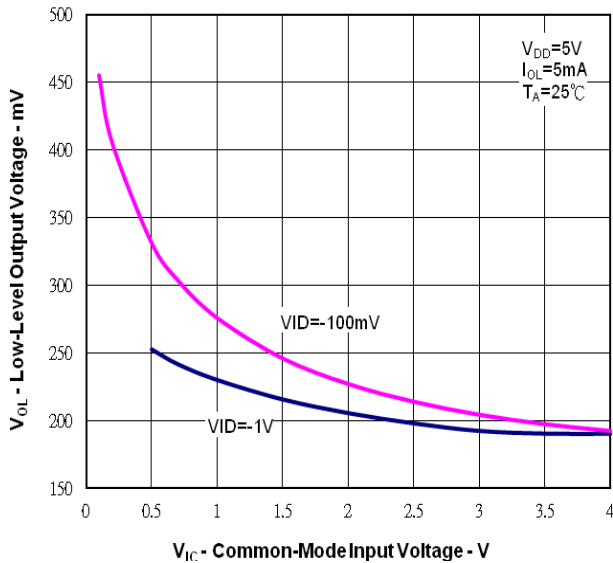

Figure 67

Low-level output voltage
vs
common-mode input voltage

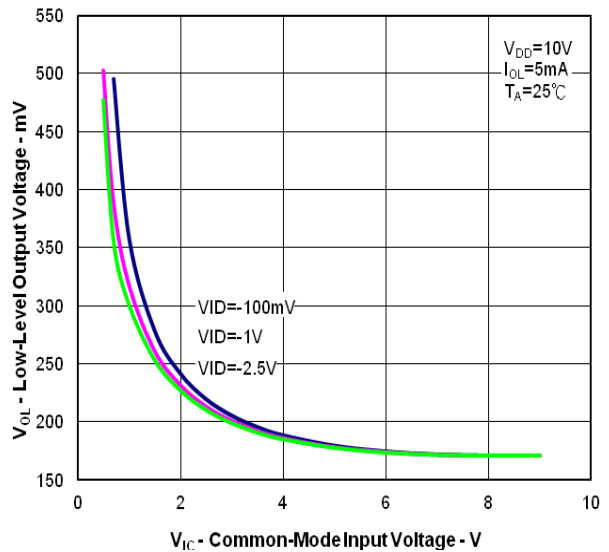

Figure 68

New Product

Typical Performance Characteristics Low Bias Mode

New Product

Low-level output voltage
vs
Differential input voltage

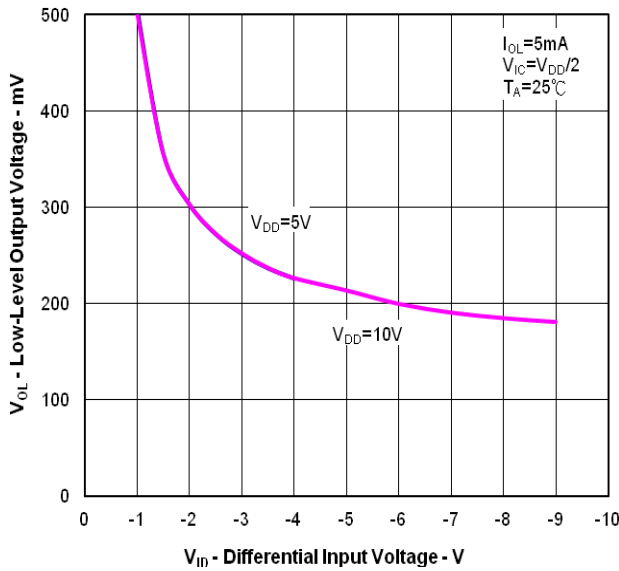

Figure 69

Low-level output voltage
vs
Differential input voltage

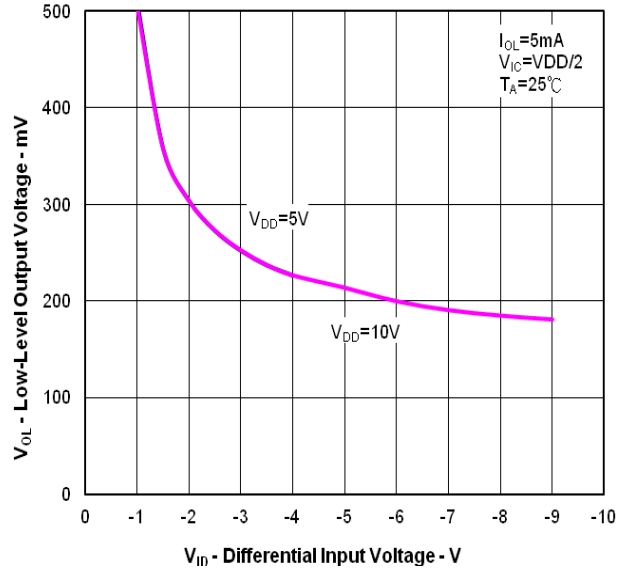

Figure 70

Low-level output voltage
vs
Low-level output current

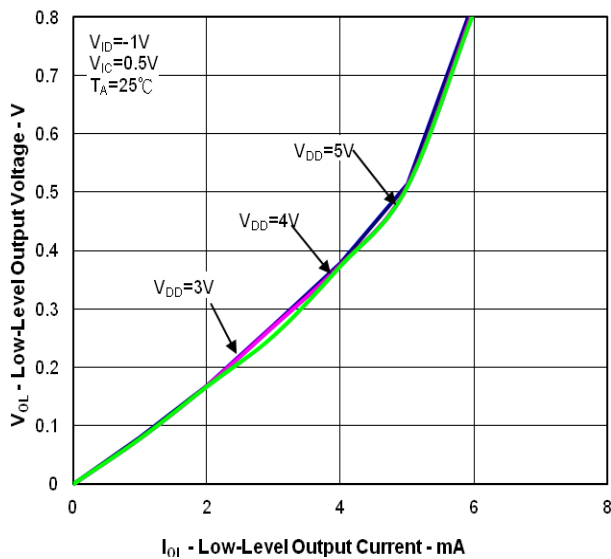

Figure 71

Low-level output voltage
vs
Low-level output current

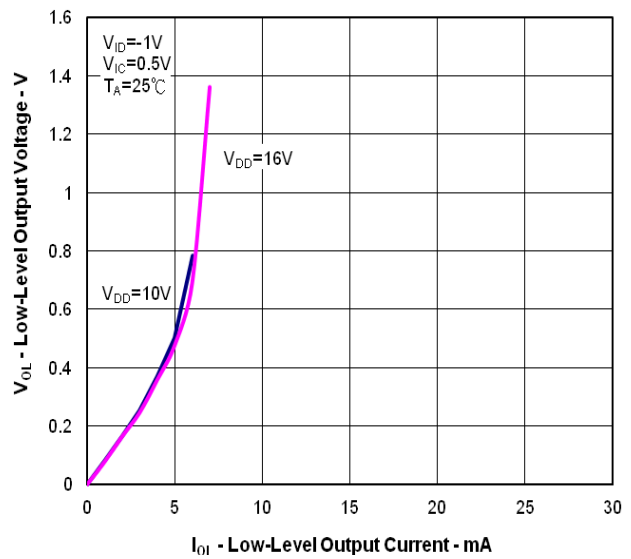

Figure 72

Typical Performance Characteristics Low Bias Mode

Large-Signal Differential Voltage Amplification
vs
Supply Voltage

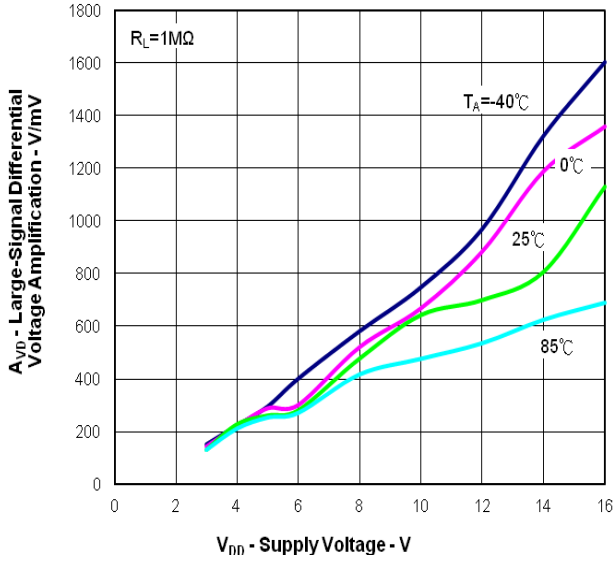

Figure 73

Large-Signal Differential Voltage Amplification
vs
Free-Air Temperature

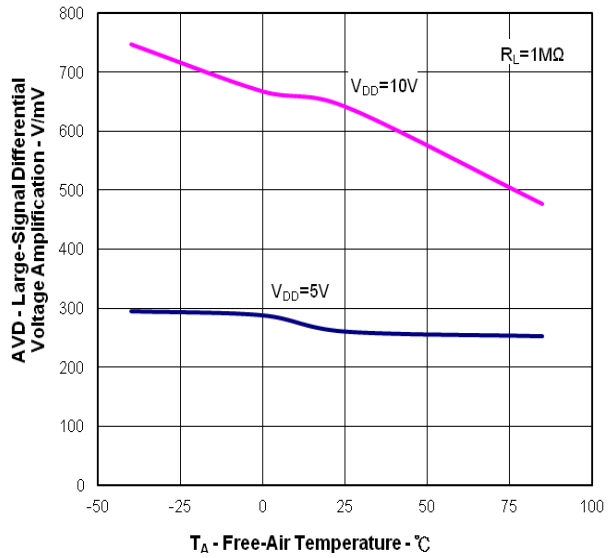

Figure 74

Input Bias Current and Input Offset Current
vs
Free-Air Temperature

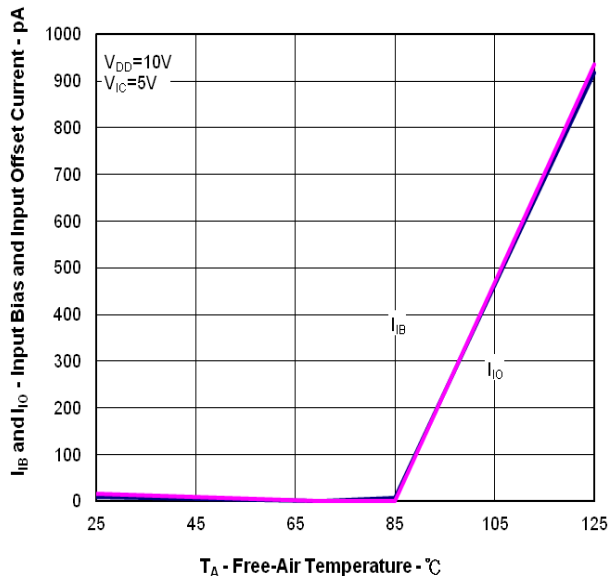

Figure 75

Common-mode input voltage
(positive limit)
vs
Supply Voltage

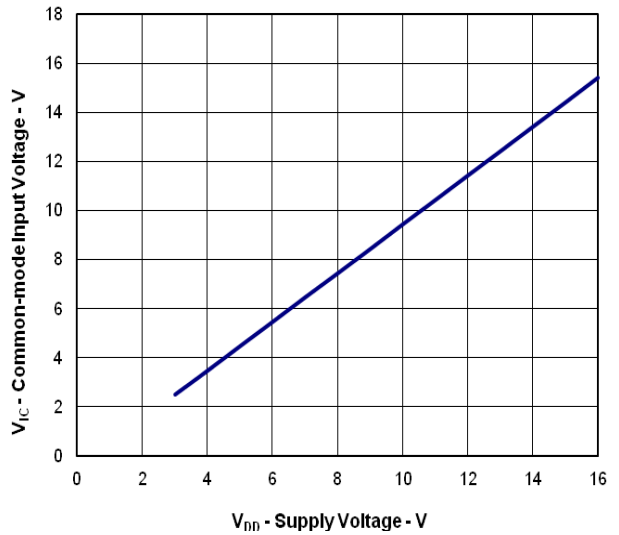

Figure 76

Typical Performance Characteristics Low Bias Mode

New Product

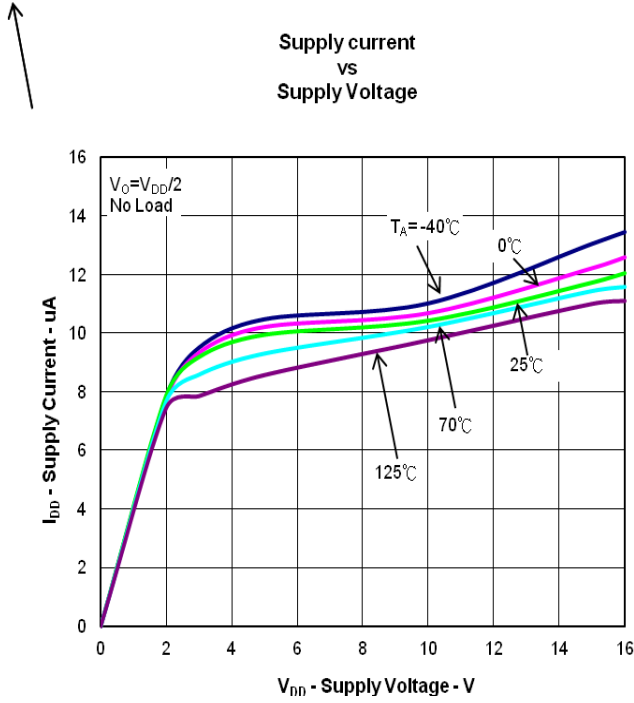

Figure 77

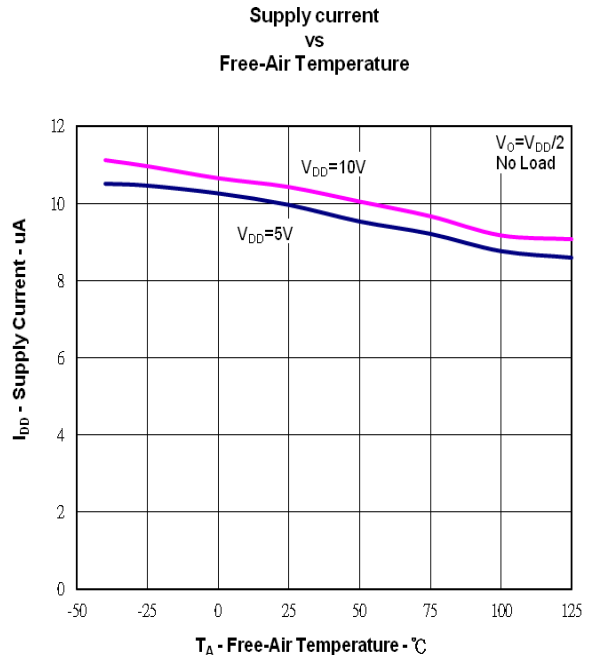

Figure 78

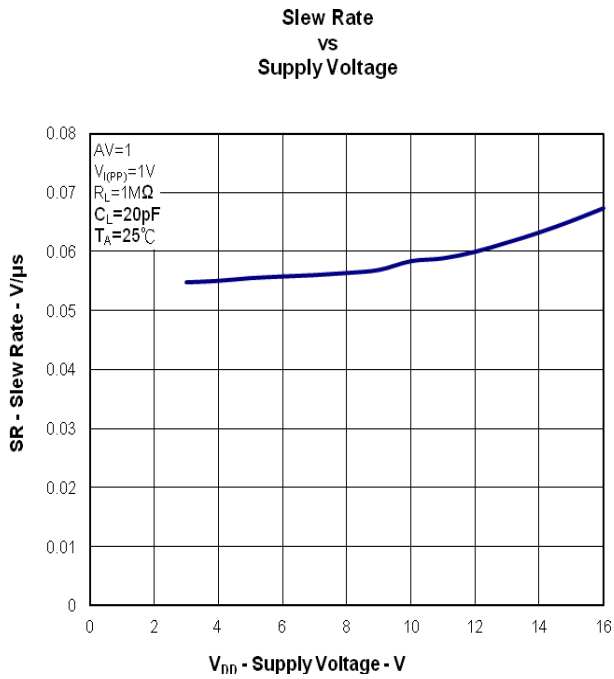

Figure 79

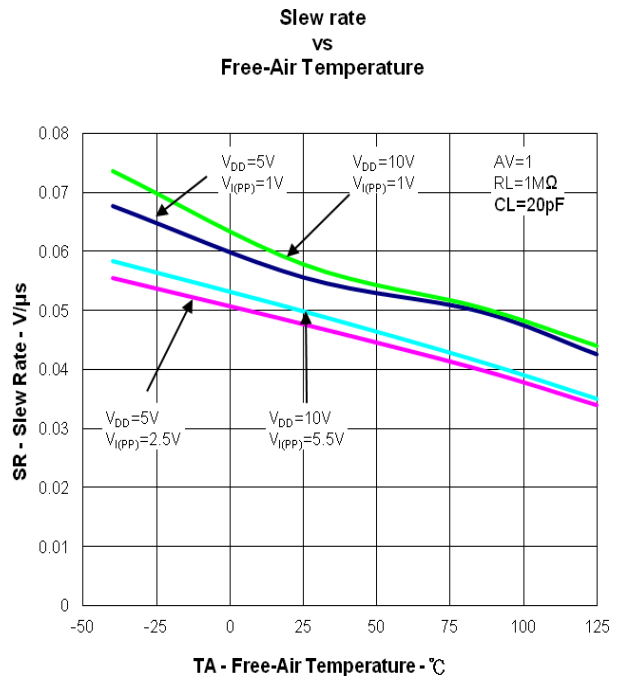
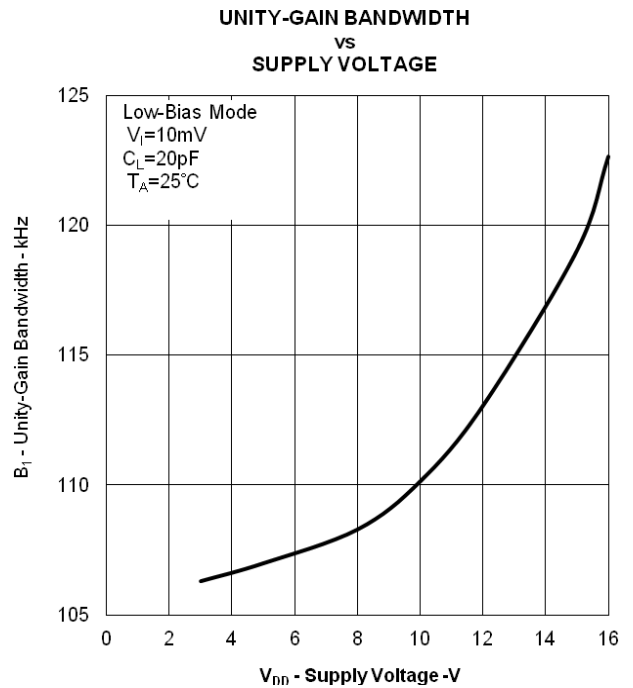
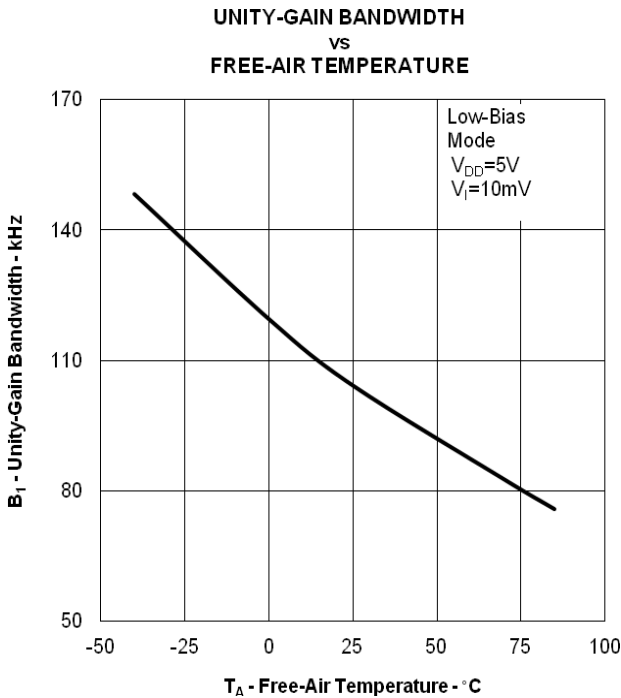
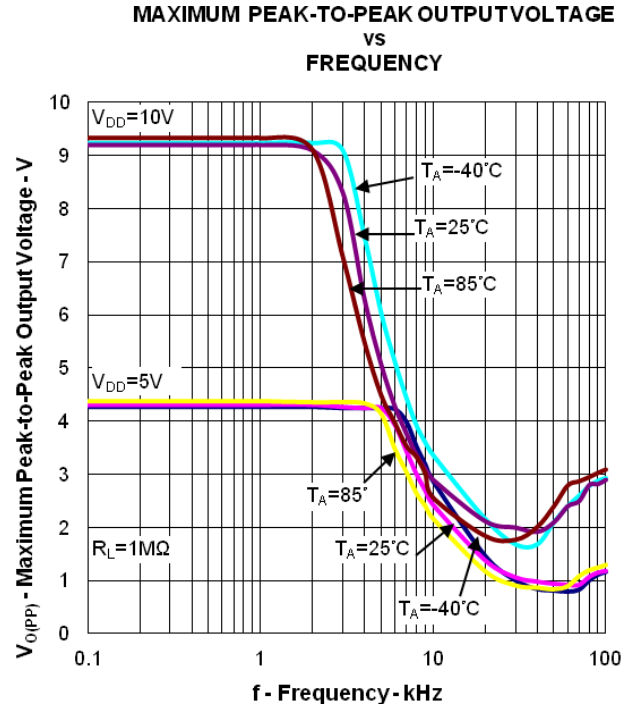
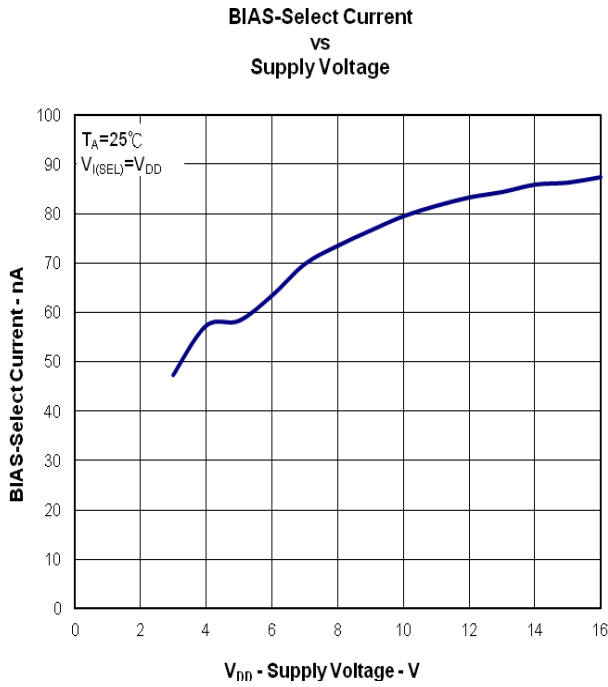

Figure 80

Typical Performance Characteristics Low Bias Mode

New Product



Typical Performance Characteristics Low Bias Mode

New Product

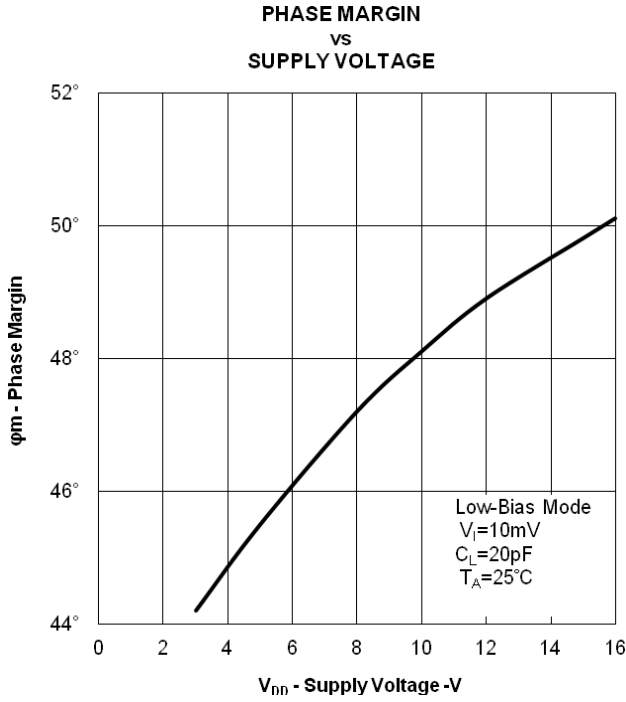

Figure 85

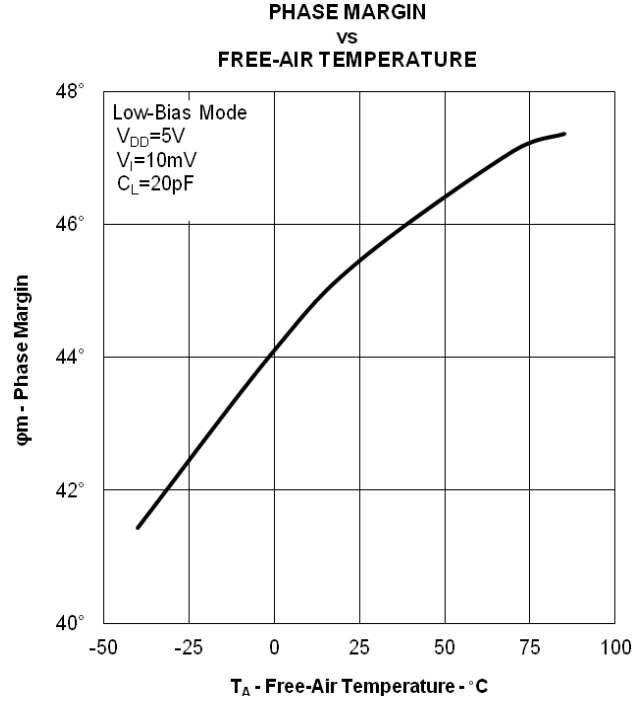

Figure 86

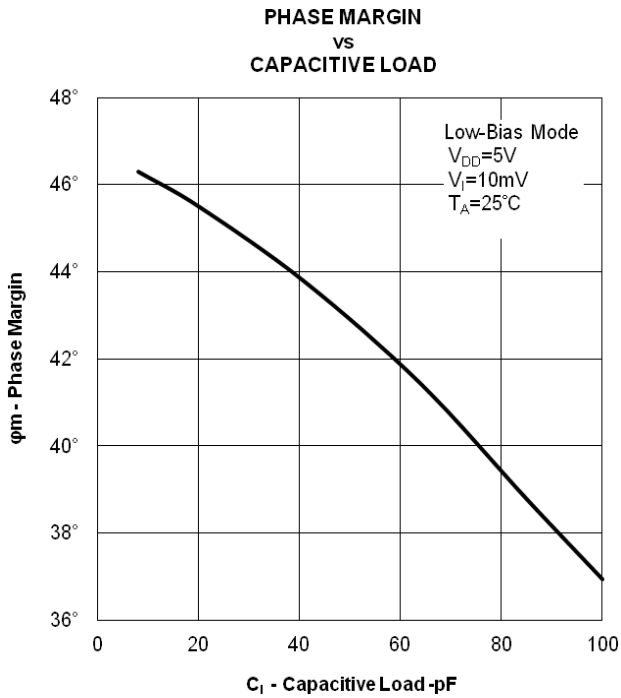

Figure 87

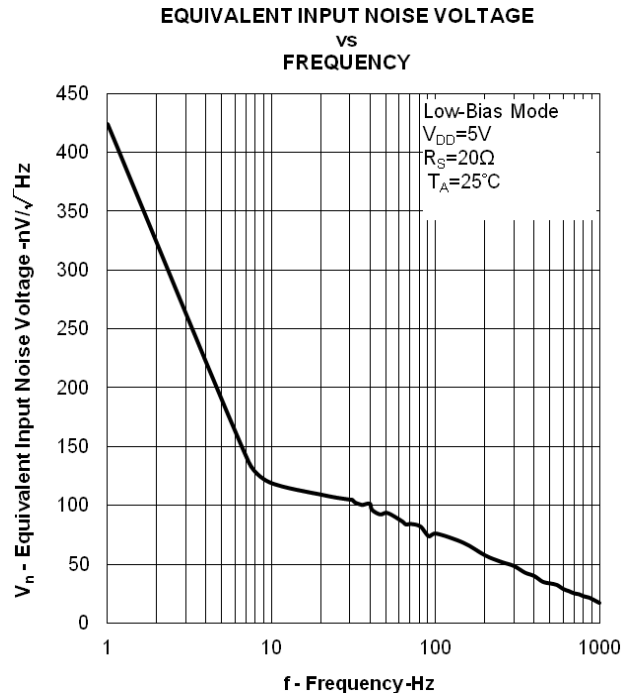
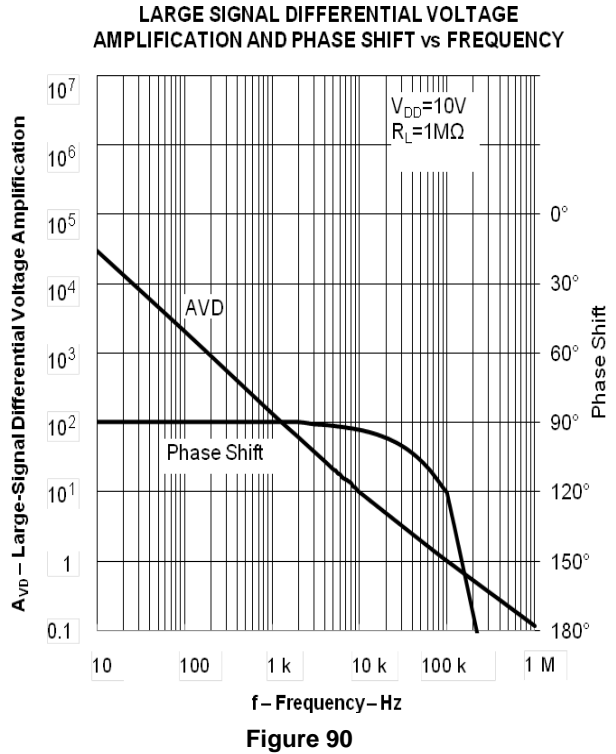
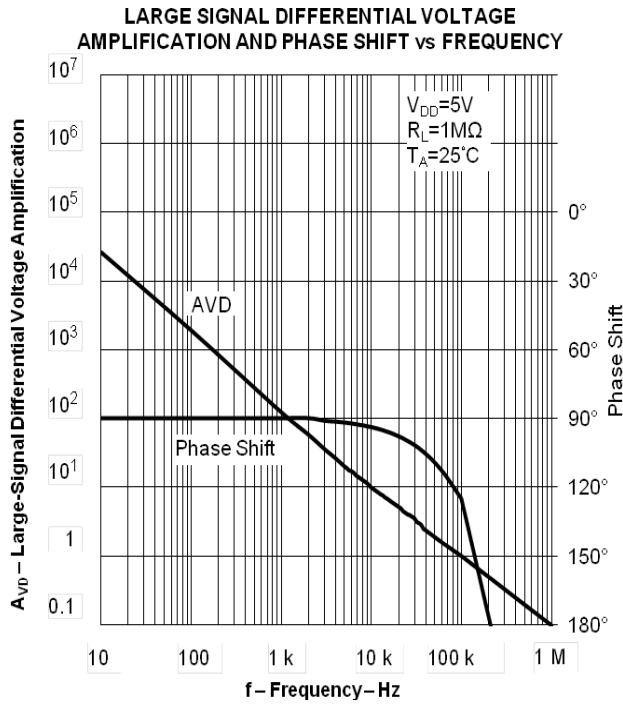

Figure 88

Typical Performance Characteristics Low Bias Mode



Application Information

Bias select feature

The TLC271 offers a bias-select feature that allows the user to select any one of three bias levels depending on the level of performance desired. The trade-off between bias levels relates to ac performance and power dissipation as below.

Typical values $T_A = +25^\circ\text{C}$, $V_{DD} = 5\text{V}$		Mode			Units
		High bias $R_L = 10\text{k}\Omega$	Medium bias $R_L = 100\text{k}\Omega$	Low bias $R_L = 1\text{M}\Omega$	
P_D	Power Dissipation	3.4	0.5	0.05	mW
SR	Slew Rate	3.6	0.4	0.03	V/ μs
V_n	Equivalent Input Noise Voltage at $f=1\text{kHz}$	20	25	28	nV/ $\sqrt{\text{Hz}}$
B_1	Unity Gain Bandwidth	1.7	0.5	0.09	MHz
ϕ_m	Phase Margin	46°	40°	34°	—
A_{VD}	Large Signal Differential Voltage Amplification	23	170	480	V/mV

Bias selection

Bias selection is achieved by connecting the bias select pin to one of three voltage levels (see below). For medium-bias applications, it is recommended that the bias select pin be connected to the midpoint between the supply rails. This procedure is simple in split-supply applications, since this point is ground.

In single-supply applications, the medium-bias mode necessitates using a voltage divider as indicated below. The use of large-value resistors in the voltage divider reduces the current drain of the divider from the supply line. However, large-value resistors used in conjunction with a large-value capacitor require significant time to charge the supply to the midpoint after the supply is switched on. A voltage other than the midpoint can be used if it is within the voltages specified table.

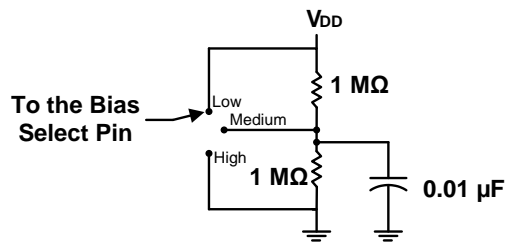

Bias Mode	Bias Select Voltage (Single Supply)
Low	V_{DD}
Medium	1 V to $V_{DD} - 1\text{ V}$
High	GND

Figure 91

High-Bias Mode

In high-bias mode, the TLC271 series features low offset voltage drift, high input impedance and low noise. Speed in this mode approaches that of BiFET devices but at only a fraction of the power dissipation. Unity-gain bandwidth is typically greater than 1 MHz.

Medium-Bias Mode

The TLC271 in medium-bias mode features low offset voltage drift, high input impedance and low noise. Speed in this mode is similar to general-purpose bipolar devices, but power dissipation is only a fraction of that consumed by bipolar devices.

Low-Bias Mode

In low-bias mode, the TLC271 features low offset voltage drift, high input impedance, extremely low power consumption and high differential voltage gain.

Application Information (cont.)

Parameter measurement circuits

Because the TLC271 is optimized for single-supply operation, circuit configurations used for the various tests can present some difficulties since the input signal must be offset from ground. This issue can be avoided by testing the device with split supplies and the output load tied to the negative rail. Example circuits are shown below.

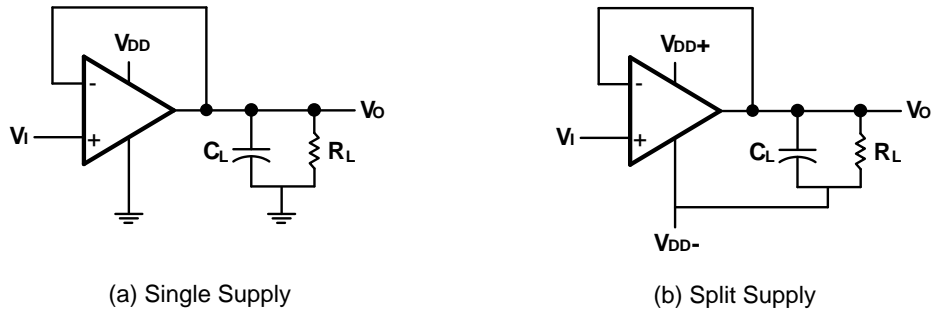

Figure 92 Measurement circuit with either single or split supply

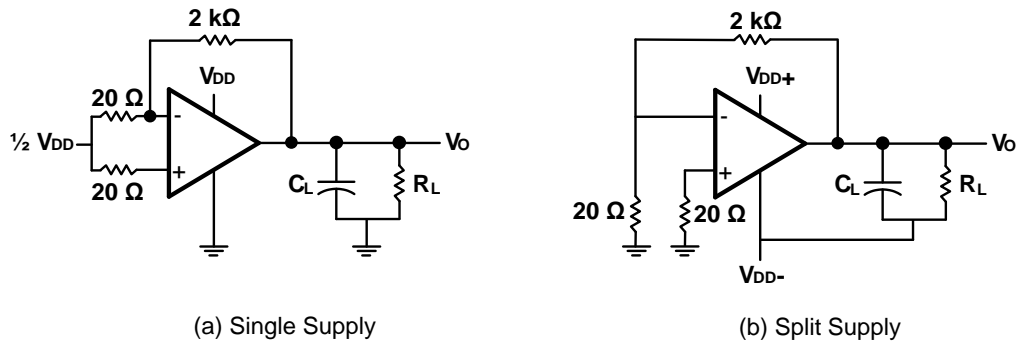

Fig 93 Noise measurement with single or split supply

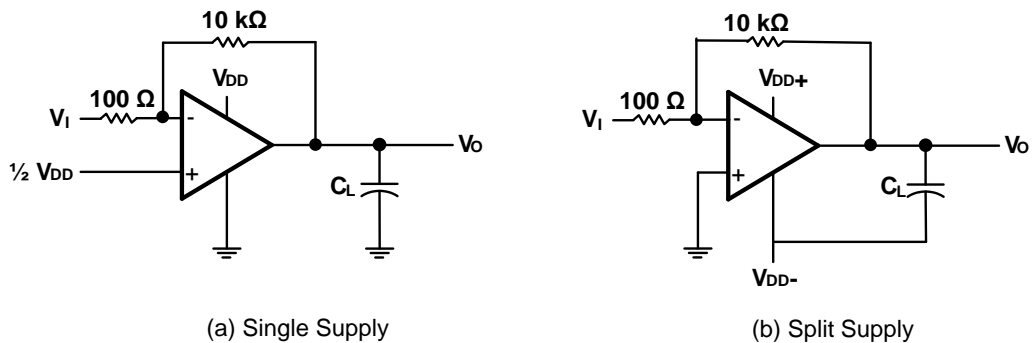

Figure 94 Gain of 100 with single or split supply

Application Notes

Offset Voltage Nulling Circuit

The TLC271 offers external input offset null control. Nulling of the input off set voltage may be achieved by adjusting a 100-kΩ potentiometer connected between the offset null terminals with the wiper connected as shown in Figure 95. The amount of nulling range varies with the bias selection. In the high-bias mode, the nulling range allows the maximum offset voltage specified to be trimmed to zero. In low-bias and medium-bias modes, total nulling may not be possible.

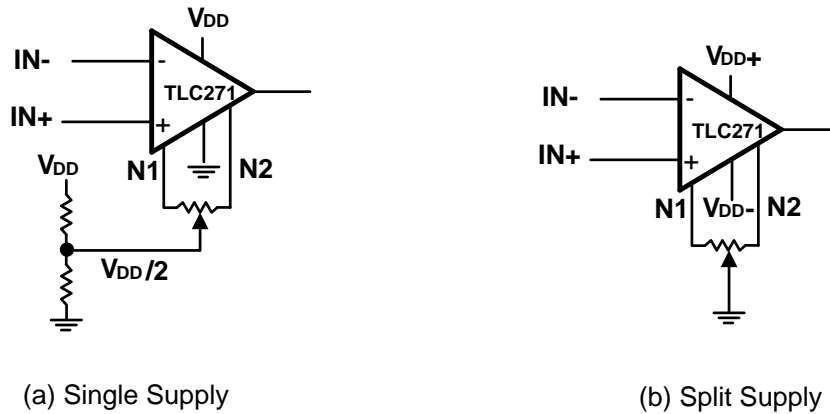

Figure 95 Offset Nulling Circuits

Input Bias Current – Error Protection

The TLC271 has an extremely high input impedance. To use the inputs as a high impedance node, for example, greater than 100K, or to accurately measure bias current, it will be necessary to place a guard ring around the input pins and drive this ring to a potential equivalent to the common mode input voltage. In many cases this common mode potential may exist as a part of the feedback circuit and can be obtained from one of the appropriate nodes. In the case for the SO8 package, pin 4 is connected to ground or Vdd-. Input pins 2 and 3 are normally well above the voltage on pin 4 so a large potential voltage on the order of several volts is likely between pins 3 and 4. To prevent interference with a 1 pA bias current the board resistance would need to be in the order of gigaohms to have a minimum impact. The goal is to have the common mode potential on the guard ring, therefore reducing the stray voltage near the input pins to millivolts in normal applications. Any solder flux residue, excess moisture, humidity or board contamination will be detrimental to using the device in a high impedance input mode.

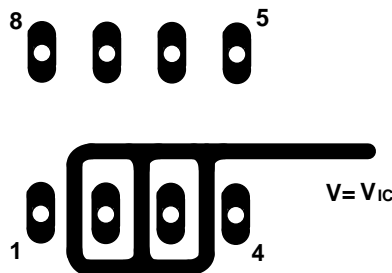

Figure 96 Bias Current Guarding for High Input Impedance Applications

Typical Application Circuits

New Product

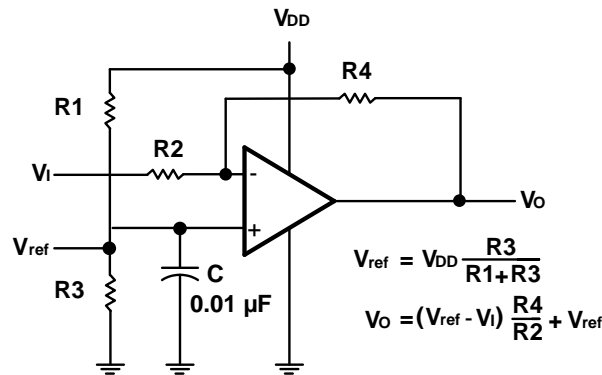

Figure 97 Inverting Amplifier With Voltage Reference

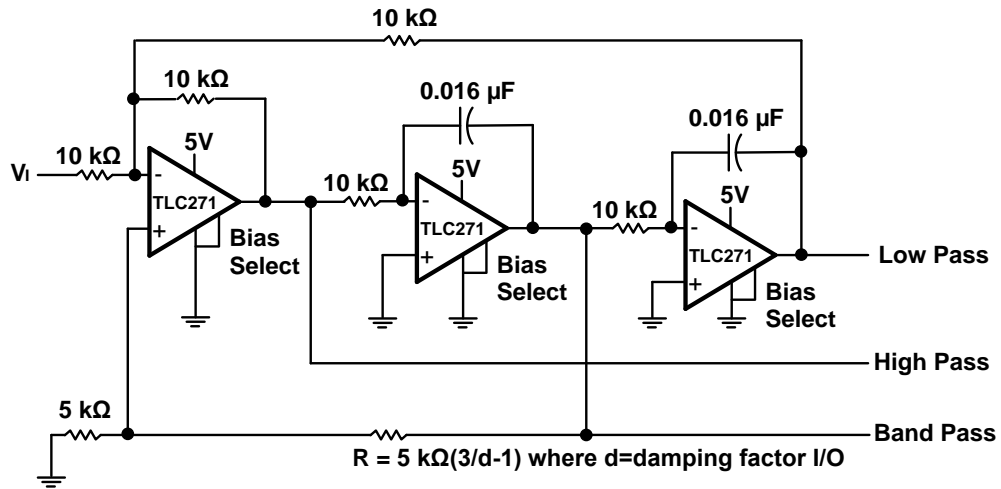

Figure 98 State Variable Filter

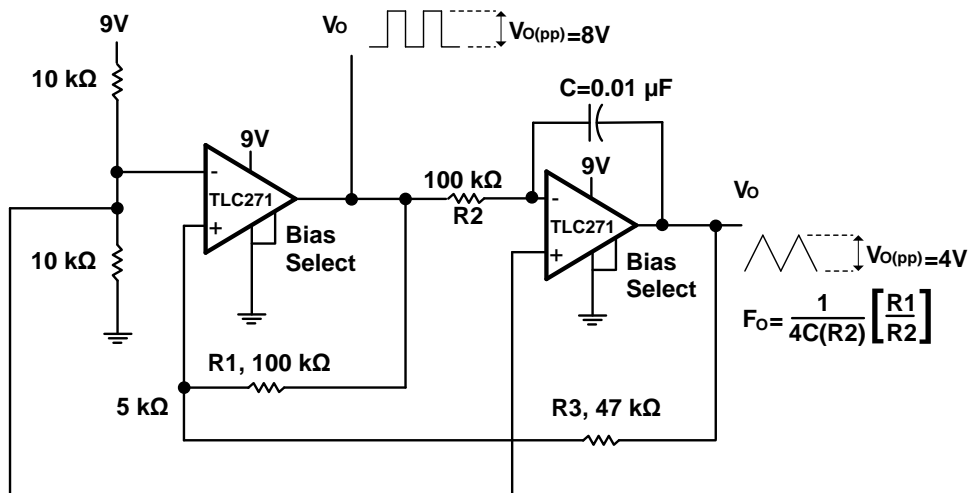

Figure 99 Single Supply Function Generator

Typical Application Circuits (cont.)

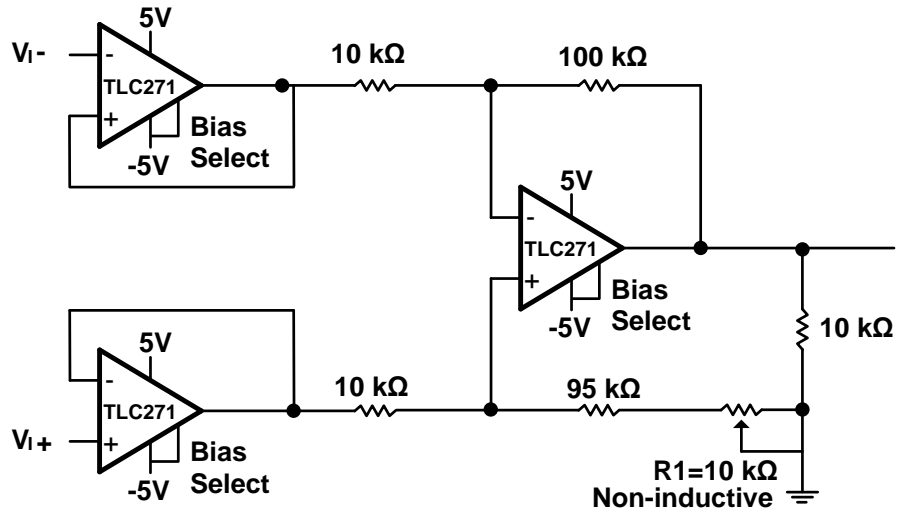
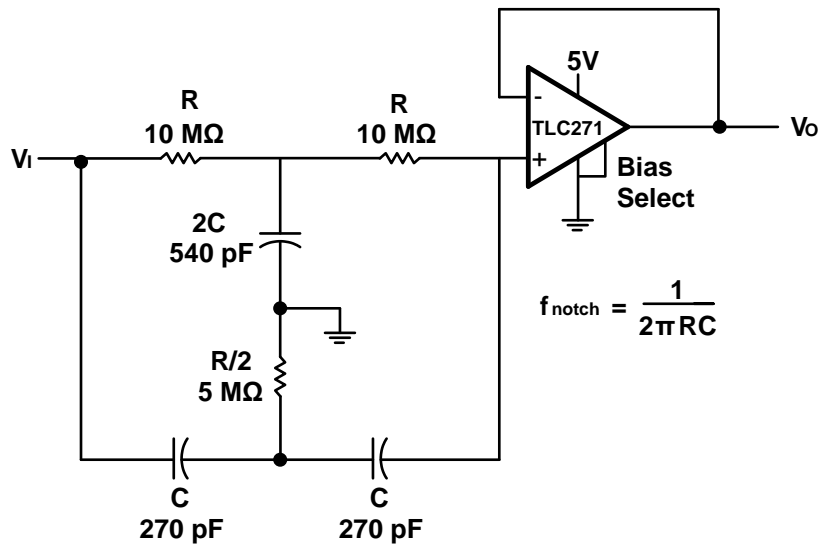

Figure 100 Low Power Instrumentation Amplifier



$$f_{\text{notch}} = \frac{1}{2\pi RC}$$

Figure 101 Single Supply Twin-T Notch Filter

Typical Application Circuits (cont.)

New Product

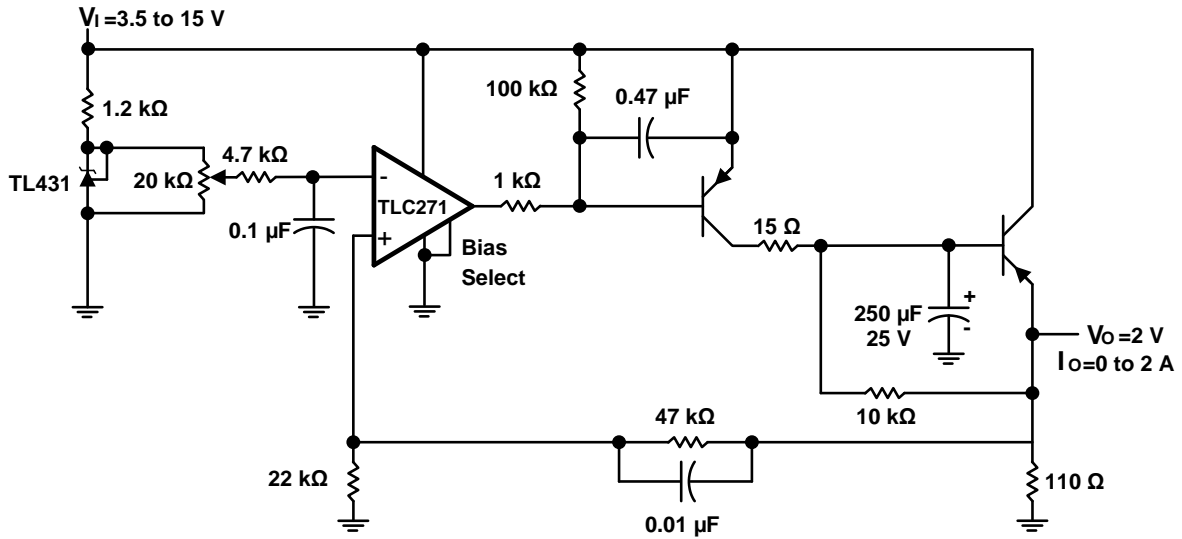

Figure 102 Power Supply

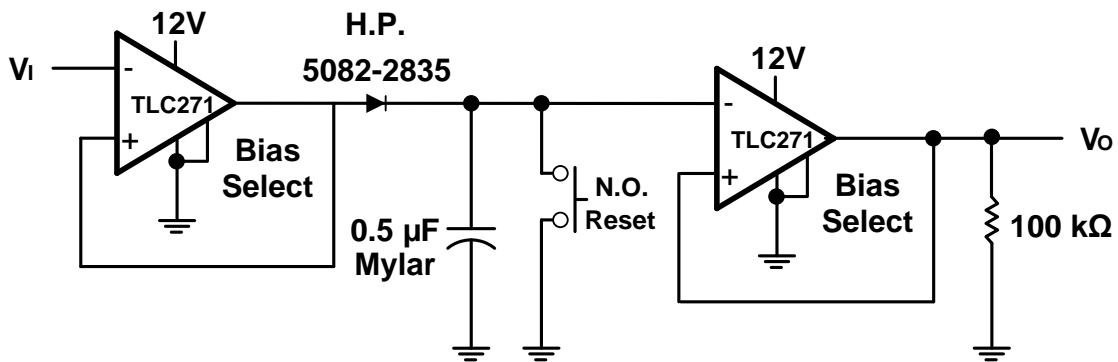

Figure 103 Positive Peak Detector

Typical Application Circuits (cont.)

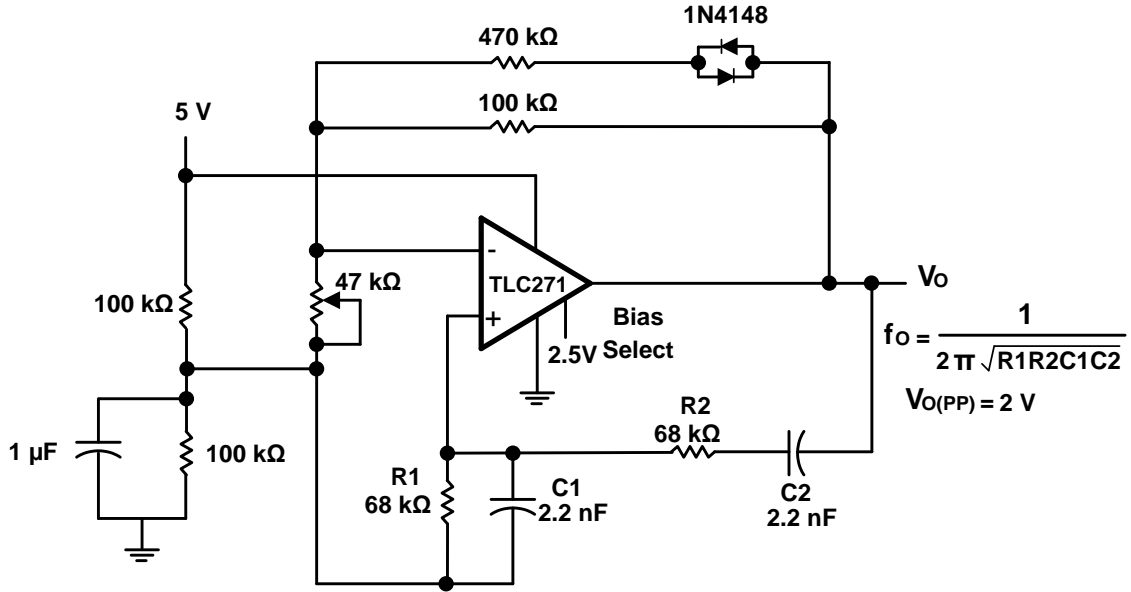

Figure 104 Wein Oscillator

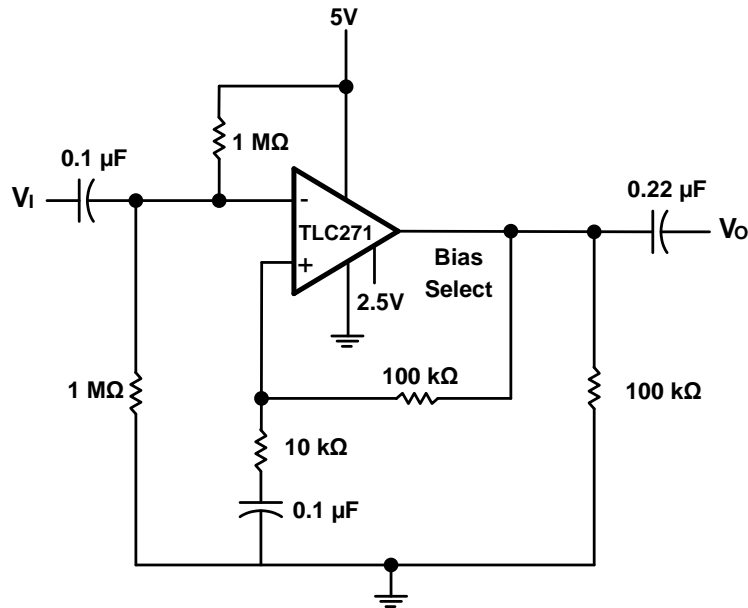

Figure 105 Single-Supply AC Amplifier

Typical Application Circuits (cont.)

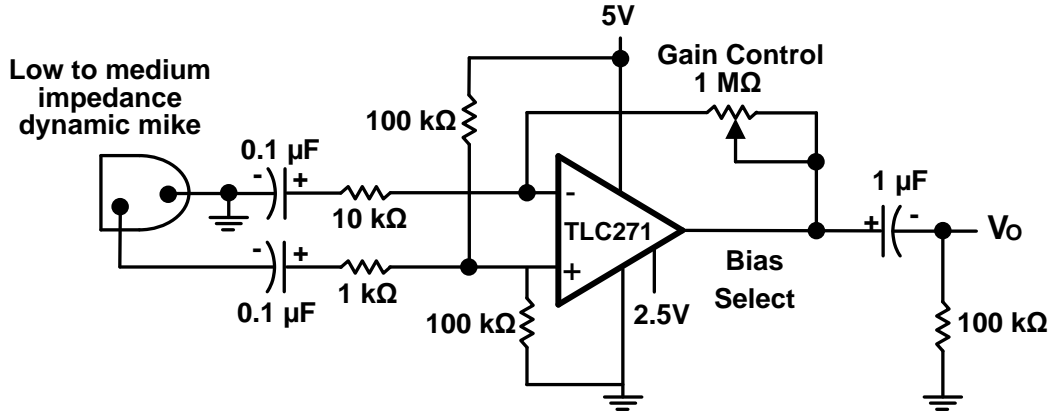
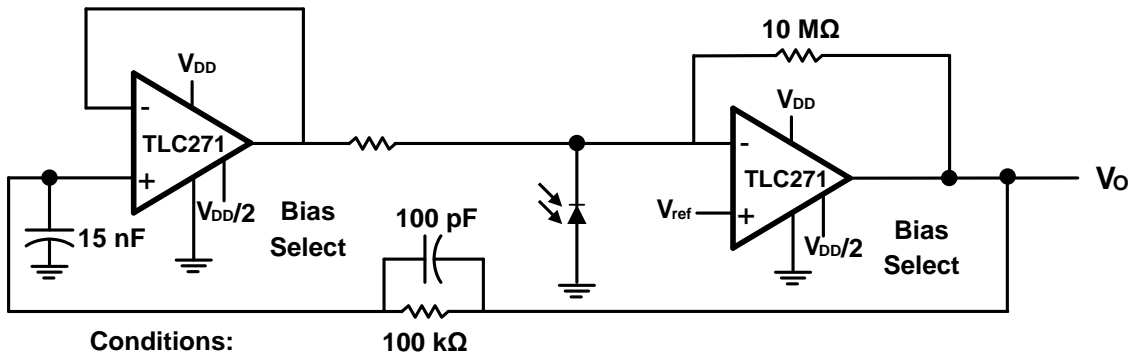
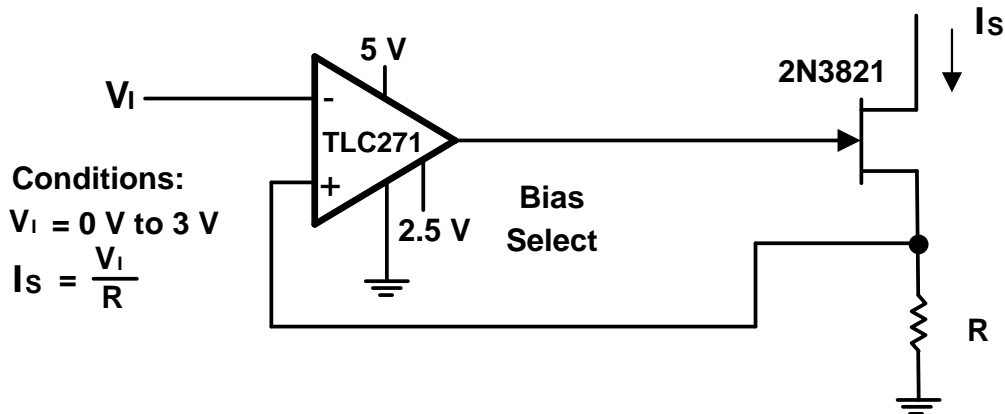

Figure 106 Microphone Preamp



Conditions:
 $V_{DD} = 4\text{ V to } 15\text{ V}$
 $V_{ref} = 0\text{ V to } V_{DD} - 2\text{ V}$

Figure 107 Photo-Diode Amplifier With Ambient Light Rejection



Conditions:
 $V_i = 0\text{ V to } 3\text{ V}$
 $I_s = \frac{V_i}{R}$

Figure 108 Precision Low-Current Sink

Typical Application Circuits (cont.)

New Product

Select	S1	S2
A_v	10	100

$V_{DD} = 5\text{ V to }12\text{ V}$

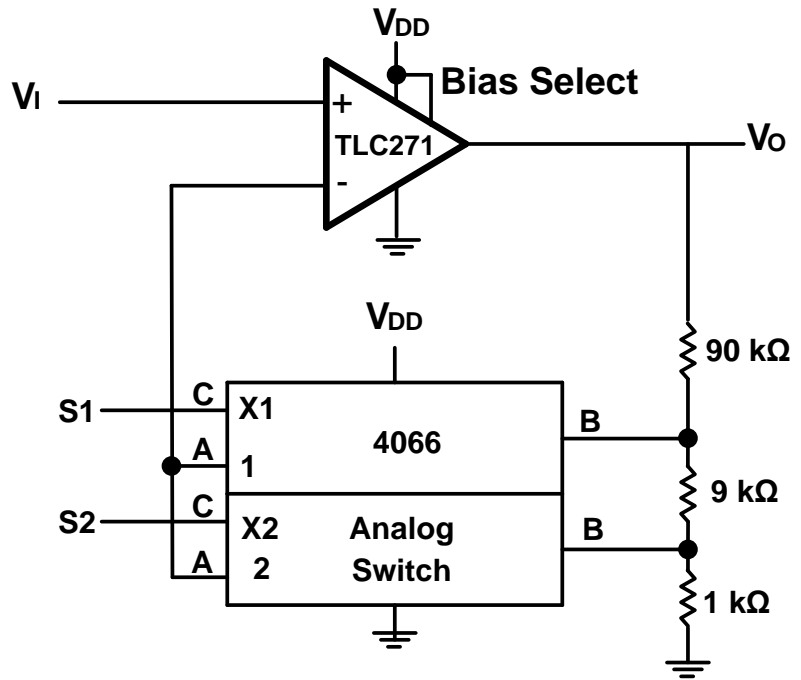

Figure 109 Amplifier With Digital Gain Selection

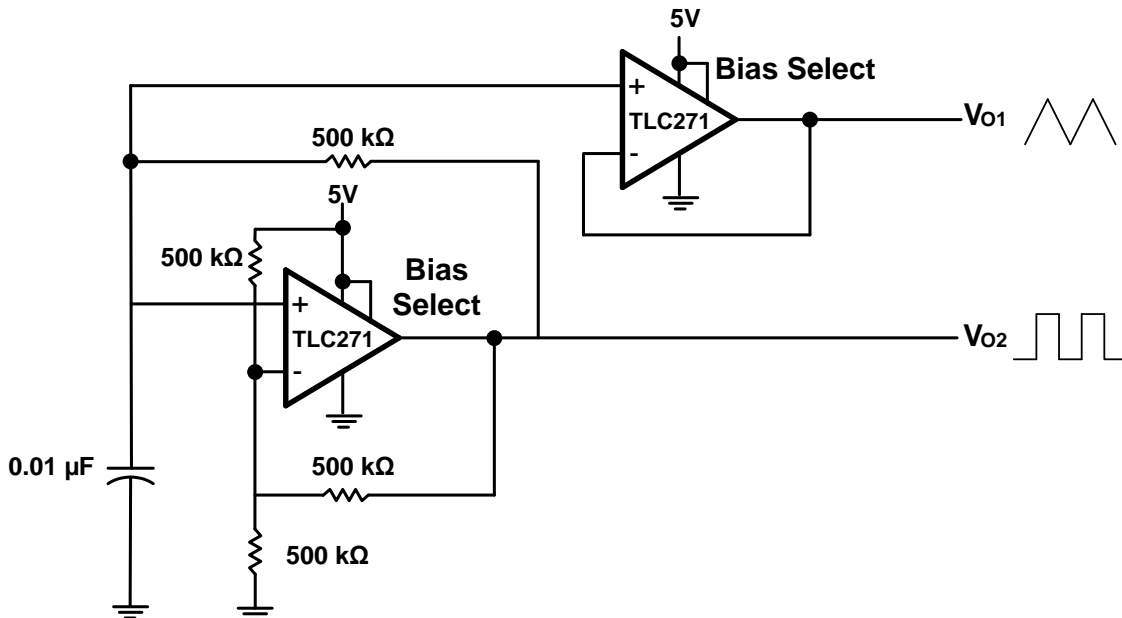

Figure 110 Multivibrator

Typical Application Circuits (cont.)

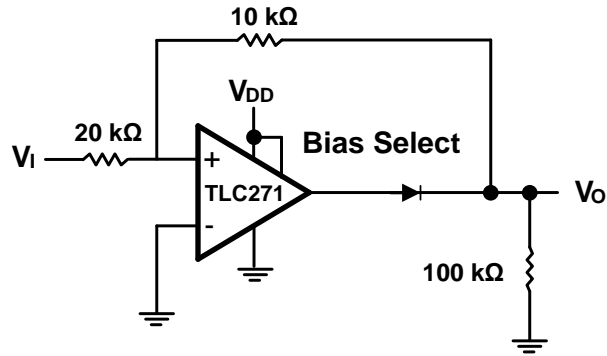
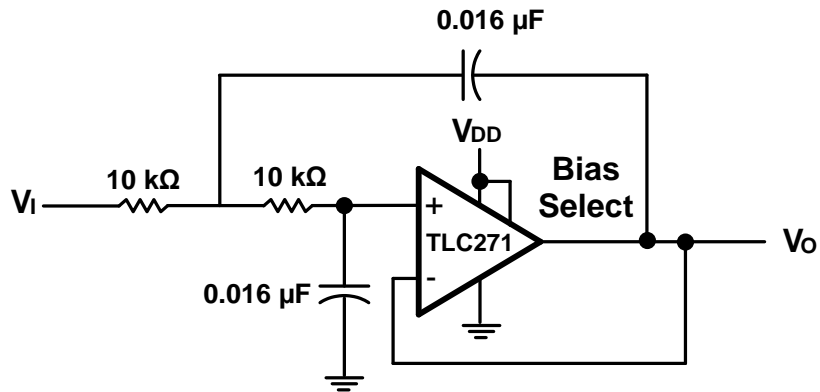

Figure 111 Full Wave Rectifier



Normalized to $F_C = 1 \text{ kHz}$ and $R_L = 10 \text{ k}\Omega$

Figure 112 Two-Pole Low-Pass Butterworth Filter

Marking Information

SO-8

Part mark	Part number
C271C	TLC271CS
C271AC	TLC271ACS
C271BC	TLC271BCS
C271I	TLC271IS
C271AI	TLC271AIS
C271BI	TLC271BIS

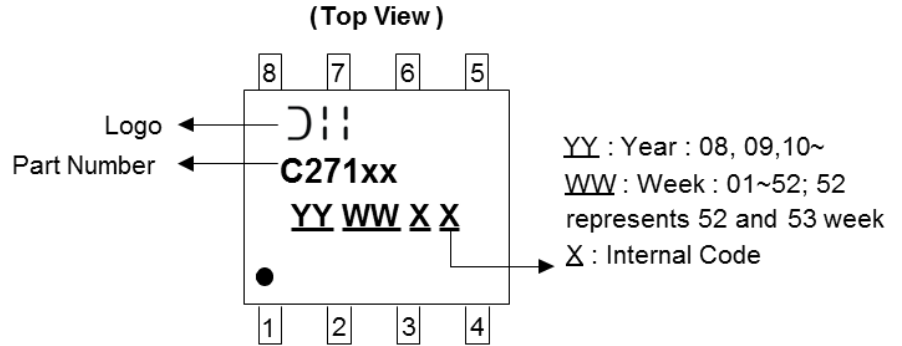

Package Outline Dimensions

Please see AP02002 at <http://www.diodes.com/datasheets/ap02002.pdf> for the latest version.

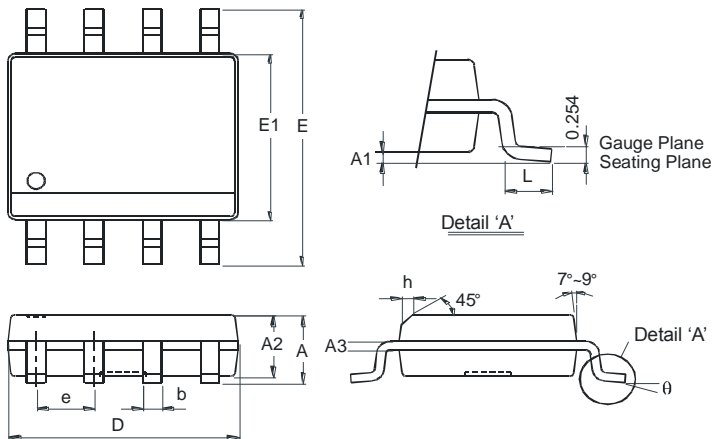

SO-8		
Dim	Min	Max
A	-	1.75
A1	0.10	0.20
A2	1.30	1.50
A3	0.15	0.25
b	0.3	0.5
D	4.85	4.95
E	5.90	6.10
E1	3.85	3.95
e	1.27 Typ	
h	-	0.35
L	0.62	0.82
θ	0°	8°
All Dimensions in mm		

IMPORTANT NOTICE

DIODES INCORPORATED MAKES NO WARRANTY OF ANY KIND, EXPRESS OR IMPLIED, WITH REGARDS TO THIS DOCUMENT, INCLUDING, BUT NOT LIMITED TO, THE IMPLIED WARRANTIES OF MERCHANTABILITY AND FITNESS FOR A PARTICULAR PURPOSE (AND THEIR EQUIVALENTS UNDER THE LAWS OF ANY JURISDICTION).

Diodes Incorporated and its subsidiaries reserve the right to make modifications, enhancements, improvements, corrections or other changes without further notice to this document and any product described herein. Diodes Incorporated does not assume any liability arising out of the application or use of this document or any product described herein; neither does Diodes Incorporated convey any license under its patent or trademark rights, nor the rights of others. Any Customer or user of this document or products described herein in such applications shall assume all risks of such use and will agree to hold Diodes Incorporated and all the companies whose products are represented on Diodes Incorporated website, harmless against all damages.

Diodes Incorporated does not warrant or accept any liability whatsoever in respect of any products purchased through unauthorized sales channel.

Should Customers purchase or use Diodes Incorporated products for any unintended or unauthorized application, Customers shall indemnify and hold Diodes Incorporated and its representatives harmless against all claims, damages, expenses, and attorney fees arising out of, directly or indirectly, any claim of personal injury or death associated with such unintended or unauthorized application.

Products described herein may be covered by one or more United States, international or foreign patents pending. Product names and markings noted herein may also be covered by one or more United States, international or foreign trademarks.

This document is written in English but may be translated into multiple languages for reference. Only the English version of this document is the final and determinative format released by Diodes Incorporated.

LIFE SUPPORT

Diodes Incorporated products are specifically not authorized for use as critical components in life support devices or systems without the express written approval of the Chief Executive Officer of Diodes Incorporated. As used herein:

A. Life support devices or systems are devices or systems which:

1. are intended to implant into the body, or
2. support or sustain life and whose failure to perform when properly used in accordance with instructions for use provided in the labeling can be reasonably expected to result in significant injury to the user.

B. A critical component is any component in a life support device or system whose failure to perform can be reasonably expected to cause the failure of the life support device or to affect its safety or effectiveness.



Customers represent that they have all necessary expertise in the safety and regulatory ramifications of their life support devices or systems, and acknowledge and agree that they are solely responsible for all legal, regulatory and safety-related requirements concerning their products and any use of Diodes Incorporated products in such safety-critical, life support devices or systems, notwithstanding any devices- or systems-related information or support that may be provided by Diodes Incorporated. Further, Customers must fully indemnify Diodes Incorporated and its representatives against any damages arising out of the use of Diodes Incorporated products in such safety-critical, life support devices or systems.

Copyright © 2014, Diodes Incorporated





www.diodes.com

Looking for pricing, stock, or lifecycle information?

Click below to explore more details on WIN SOURCE:

-  [View TLC271ACS-13 on WIN SOURCE](#)
-  [Diodes Incorporated Information](#)

Optimize Your Supply Chain with WIN SOURCE Solutions

-  Global Sourcing Solution
-  Obsolete Management
-  Cost Control Management
-  Shortage Management
-  Alternative Solution
-  Excess Inventory Management