



# THE DATASHEET OF TLC2272CPS



## TLC227x, TLC227xA: Advanced LinCMOS Rail-to-Rail Operational Amplifiers

### 1 Features

- Output Swing Includes Both Supply Rails
- Low Noise: 9 nV/√Hz Typical at f = 1 kHz
- Low-Input Bias Current: 1-pA Typical
- Fully-Specified for Both Single-Supply and Split-Supply Operation
- Common-Mode Input Voltage Range Includes Negative Rail
- High-Gain Bandwidth: 2.2-MHz Typical
- High Slew Rate: 3.6-V/μs Typical
- Low Input Offset Voltage: 950 μV Maximum at T<sub>A</sub> = 25°C
- Macromodel Included
- Performance Upgrades for the TLC272 and TLC274
- Available in Q-Temp Automotive

### 2 Applications

- White Goods (Refrigerators, Washing Machines)
- Hand-held Monitoring Systems
- Configuration Control and Print Support
- Transducer Interfaces
- Battery-Powered Applications

### 3 Description

The TLC2272 and TLC2274 are dual and quadruple operational amplifiers from Texas Instruments. Both devices exhibit rail-to-rail output performance for increased dynamic range in single- or split-supply applications. The TLC227x family offers 2 MHz of bandwidth and 3 V/μs of slew rate for higher-speed applications. These devices offer comparable AC performance while having better noise, input offset voltage, and power dissipation than existing CMOS operational amplifiers. The TLC227x has a noise voltage of 9 nV/√Hz, two times lower than competitive solutions.

The TLC227x family of devices, exhibiting high input impedance and low noise, is excellent for small-signal conditioning for high-impedance sources such as piezoelectric transducers. Because of the micropower dissipation levels, these devices work well in hand-held monitoring and remote-sensing applications. In addition, the rail-to-rail output feature, with single- or split-supplies, makes this family a great choice when interfacing with analog-to-digital converters (ADCs). For precision applications, the TLC227xA family is available with a maximum input offset voltage of 950 μV. This family is fully characterized at 5 V and ±5 V.

The TLC227x also make great upgrades to the TLC27x in standard designs. They offer increased output dynamic range, lower noise voltage, and lower input offset voltage. This enhanced feature set allows them to be used in a wider range of applications. For applications that require higher output drive and wider input voltage range, see the TLV2432 and TLV2442 devices.

If the design requires single amplifiers, see the TLV2211, TLV2221 and TLV2231 family. These devices are single rail-to-rail operational amplifiers in the SOT-23 package. Their small size and low power consumption make them ideal for high density, battery-powered equipment.

Device Information<sup>(1)</sup>

PART NUMBER	PACKAGE	BODY SIZE (NOM)
TLC2272	TSSOP (8)	4.40 mm × 3.00 mm
	SOIC (8)	3.91 mm × 4.90 mm
	SO (8)	5.30 mm × 6.20 mm
	PDIP (8)	6.35 mm × 9.81 mm
TLC2274	TSSOP (14)	4.40 mm × 5.00 mm
	SOIC (14)	3.91 mm × 8.65 mm
	SO (14)	5.30 mm × 10.30 mm
	PDIP (14)	6.35 mm × 19.30 mm

(1) For all available packages, see the orderable addendum at the end of the data sheet.

Maximum Peak-to-Peak Output Voltage vs Supply Voltage



## Table of Contents

<b>1 Features</b> .....	<b>1</b>	7.1 Overview .....	24
<b>2 Applications</b> .....	<b>1</b>	7.2 Functional Block Diagram .....	24
<b>3 Description</b> .....	<b>1</b>	7.3 Feature Description .....	24
<b>4 Revision History</b> .....	<b>2</b>	7.4 Device Functional Modes .....	24
<b>5 Pin Configuration and Functions</b> .....	<b>3</b>	<b>8 Application and Implementation</b> .....	<b>25</b>
<b>6 Specifications</b> .....	<b>5</b>	8.1 Application Information .....	25
6.1 Absolute Maximum Ratings .....	5	8.2 Typical Application .....	26
6.2 ESD Ratings .....	5	<b>9 Power Supply Recommendations</b> .....	<b>28</b>
6.3 Recommended Operating Conditions .....	5	<b>10 Layout</b> .....	<b>29</b>
6.4 Thermal Information .....	6	10.1 Layout Guidelines .....	29
6.5 TLC2272 and TLC2272A Electrical Characteristics V <sub>DD</sub> = 5 V .....	6	10.2 Layout Example .....	29
6.6 TLC2272 and TLC2272A Electrical Characteristics V <sub>DD±</sub> = ±5 V .....	8	<b>11 Device and Documentation Support</b> .....	<b>30</b>
6.7 TLC2274 and TLC2274A Electrical Characteristics V <sub>DD</sub> = 5 V .....	9	11.1 Related Links .....	30
6.8 TLC2274 and TLC2274A Electrical Characteristics V <sub>DD±</sub> = ±5 V .....	11	11.2 Community Resources .....	30
6.9 Typical Characteristics .....	13	11.3 Trademarks .....	30
<b>7 Detailed Description</b> .....	<b>24</b>	11.4 Electrostatic Discharge Caution .....	30
		11.5 Glossary .....	30
		<b>12 Mechanical, Packaging, and Orderable Information</b> .....	<b>30</b>

## 4 Revision History

Changes from Revision G (May 2004) to Revision H	Page
• Added <i>Feature Description</i> section, <i>Device Functional Modes</i> , <i>Application and Implementation</i> section, <i>Power Supply Recommendations</i> section, <i>Layout</i> section, <i>Device and Documentation Support</i> section, and <i>Mechanical, Packaging, and Orderable Information</i> section. ....	1
• Added ESD Rating table for the D and PW package devices. ....	5

## 5 Pin Configuration and Functions

**TLC2272**  
D, JG, P, or PW Package  
8-Pin SOIC, CDIP, PDIP, or TSSOP  
Top View



**TLC2272**  
FK Package  
20-Pin LCCC  
Top View



**TLC2272**  
U Package  
10-Pin CFP  
Top View



**TLC2274**  
D, J, N, PW, or W Package  
14-Pin SOIC, CDIP, PDIP, TSSOP, or CFP  
Top View



**TLC2274**  
FK Package  
20-Pin LCCC  
Top View



### Pin Functions

NAME	PIN					I/O	DESCRIPTION
	NO.						
	TLC2272			TLC2274			
	D, JG, P, or PW	FK	U	D, J, N, PW, or W	FK		
1IN+	3	7	4	3	4	I	Non-inverting input, Channel 1
1IN-	2	5	3	2	3	I	Inverting input, Channel 1
1OUT	1	2	2	1	2	O	Output, Channel 1
2IN+	5	12	6	5	8	I	Non-inverting input, Channel 2
2IN-	6	15	7	6	9	I	Inverting input, Channel 2
2OUT	7	17	8	7	10	O	Output, Channel 2
3IN+	—	—	—	10	14	I	Non-inverting input, Channel 3
3IN-	—	—	—	9	13	I	Inverting input, Channel 3
3OUT	—	—	—	8	12	O	Output, Channel 3
4IN+	—	—	—	12	18	I	Non-inverting input, Channel 4
4IN-	—	—	—	13	19	I	Inverting input, Channel 4
4OUT	—	—	—	14	20	O	Output, Channel 4
V <sub>DD+</sub>	8	20	9	4	6	—	Positive (highest) supply
V <sub>DD-</sub>	—	—	—	11	16	—	Negative (lowest) supply
V <sub>DD-/GND</sub>	4	10	5	—	—	—	Negative (lowest) supply
NC	—	1, 3, 4, 6, 8, 9, 11, 13, 14, 16, 18, 19	1, 10	—	1, 5, 7, 11, 15, 17	—	No Connection

## 6 Specifications

### 6.1 Absolute Maximum Ratings

over operating free-air temperature range (unless otherwise noted)<sup>(1)</sup>

		MIN	MAX	UNIT
Supply voltage, $V_{DD+}$ <sup>(2)</sup>			8	V
$V_{DD-}$ <sup>(2)</sup>		-8		V
Differential input voltage, $V_{ID}$ <sup>(3)</sup>			±16	V
Input voltage, $V_I$ (any input) <sup>(2)</sup>		$V_{DD-} - 0.3$	$V_{DD+}$	V
Input current, $I_I$ (any input)			±5	mA
Output current, $I_O$			±50	mA
Total current into $V_{DD+}$			±50	mA
Total current out of $V_{DD-}$			±50	mA
Duration of short-circuit current at (or below) 25°C <sup>(4)</sup>		Unlimited		
Operating free-air temperature range, $T_A$	C level parts	0	70	°C
	I, Q level parts	-40	125	
	M level parts	-55	125	
Lead temperature 1,6 mm (1/16 inch) from case for 10 seconds	D, N, P or PW package		260	°C
Lead temperature 1,6 mm (1/16 inch) from case for 60 seconds	J or U package		300	°C
Storage temperature, $T_{stg}$		-65	150	°C

- (1) Stresses beyond those listed under *Absolute Maximum Ratings* may cause permanent damage to the device. These are stress ratings only, which do not imply functional operation of the device at these or any other conditions beyond those indicated under *Recommended Operating Conditions*. Exposure to absolute-maximum-rated conditions for extended periods may affect device reliability.
- (2) All voltage values, except differential voltages, are with respect to the midpoint between  $V_{DD+}$  and  $V_{DD-}$ .
- (3) Differential voltages are at  $IN+$  with respect to  $IN-$ . Excessive current will flow if input is brought below  $V_{DD-} - 0.3$  V.
- (4) The output may be shorted to either supply. Temperature or supply voltages must be limited to ensure that the maximum dissipation rating is not exceeded.

### 6.2 ESD Ratings

			VALUE	UNIT
$V_{(ESD)}$ Electrostatic discharge	Human-body model (HBM), per AEC Q100-002 <sup>(1)</sup>	Q-grade and M-grade devices in D and PW packages	±2000	V
	Charged-device model (CDM), per AEC Q100-011	Q-grade and M-grade devices in D and PW packages	±1000	

- (1) AEC Q100-002 indicates that HBM stressing shall be in accordance with the ANSI/ESDA/JEDEC JS-001 specification.

### 6.3 Recommended Operating Conditions

		MIN	MAX	UNIT
$V_{DD±}$ Supply voltage	C LEVEL PARTS	±2.2	±8	V
	I LEVEL PARTS	±2.2	±8	
	Q LEVEL PARTS	±2.2	±8	
	M LEVEL PARTS	±2.2	±8	
$V_I$ Input voltage	C LEVEL PARTS	$V_{DD-}$	$V_{DD+} - 1.5$	V
	I LEVEL PARTS	$V_{DD-}$	$V_{DD+} - 1.5$	
	Q LEVEL PARTS	$V_{DD-}$	$V_{DD+} - 1.5$	
	M LEVEL PARTS	$V_{DD-}$	$V_{DD+} - 1.5$	
$V_{IC}$ Common-mode input voltage	C LEVEL PARTS	$V_{DD-}$	$V_{DD+} - 1.5$	V
	I LEVEL PARTS	$V_{DD-}$	$V_{DD+} - 1.5$	
	Q LEVEL PARTS	$V_{DD-}$	$V_{DD+} - 1.5$	
	M LEVEL PARTS	$V_{DD-}$	$V_{DD+} - 1.5$	

## Recommended Operating Conditions (continued)

		MIN	MAX	UNIT	
T <sub>A</sub>	Operating free-air temperature	C LEVEL PARTS	0	70	°C
		I LEVEL PARTS	-40	125	
		Q LEVEL PARTS	-40	125	
		M LEVEL PARTS	-55	125	

## 6.4 Thermal Information

THERMAL METRIC <sup>(1)</sup>	TLC2272					TLC2274					UNIT	
	D (SOIC)	P (PDIP)	PW (TSSOP)	FK (LCCC)	U (CFP)	D (SOIC)	N (PDIP)	PW (TSSOP)	FK (LCCC)	J (CDIP)		
	8-PIN	8-PIN	8-PIN	20-PIN	10-PIN	14-PIN	14-PIN	14-PIN	20-PIN	14-PIN		
R <sub>θJA</sub>	Junction-to-ambient thermal resistance <sup>(2)(3)</sup>	115.6	58.5	175.8	—	—	83.8	—	111.6	—	—	°C/W
R <sub>θJC(top)</sub>	Junction-to-case (top) thermal resistance <sup>(2)(3)</sup>	61.8	48.3	58.8	18	121.3	43.2	34	41.2	16	16.2	°C/W
R <sub>θJB</sub>	Junction-to-board thermal resistance	55.9	35.6	104.3	—	—	38.4	—	54.7	—	—	°C/W
ψ <sub>JT</sub>	Junction-to-top characterization parameter	14.3	25.9	5.9	—	—	9.4	—	3.9	—	—	°C/W
ψ <sub>JB</sub>	Junction-to-board characterization parameter	55.4	35.5	102.6	—	—	38.1	—	53.9	—	—	°C/W
R <sub>θJC(bot)</sub>	Junction-to-case (bottom) thermal resistance	—	—	—	—	8.68	—	—	—	—	—	°C/W

(1) For more information about traditional and new thermal metrics, see the *Semiconductor and IC Package Thermal Metrics* application report, [SPRA953](#).

(2) Maximum power dissipation is a function of T<sub>J(max)</sub>, θ<sub>JA</sub>, and T<sub>A</sub>. The maximum allowable power dissipation at any allowable ambient temperature is P<sub>D</sub> = (T<sub>J(max)</sub> - T<sub>A</sub>) / θ<sub>JA</sub>. Operating at the absolute maximum T<sub>J</sub> of 150°C can affect reliability.

(3) The package thermal impedance is calculated in accordance with JESD 51-7 (plastic) or MIL-STD-883 Method 1012 (ceramic).

## 6.5 TLC2272 and TLC2272A Electrical Characteristics V<sub>DD</sub> = 5 V

at specified free-air temperature, V<sub>DD</sub> = 5 V; T<sub>A</sub> = 25°C, unless otherwise noted.

PARAMETER	TEST CONDITIONS	MIN	TYP	MAX	UNIT			
V <sub>IO</sub>	Input offset voltage	V <sub>IC</sub> = 0 V, V <sub>DD±</sub> = ±2.5 V, V <sub>O</sub> = 0 V, R <sub>S</sub> = 50 Ω	TLC2272	T <sub>A</sub> = 25°C	300	2500	μV	
			TLC2272A	T <sub>A</sub> = 25°C	300	950		
		Full Range <sup>(1)</sup>	TLC2272			3000		
			TLC2272A			1500		
α <sub>VIO</sub>	Temperature coefficient of input offset voltage	V <sub>IC</sub> = 0 V, V <sub>DD±</sub> = ±2.5 V, V <sub>O</sub> = 0 V, R <sub>S</sub> = 50 Ω			2	μV/°C		
	Input offset voltage long-term drift <sup>(2)</sup>	V <sub>IC</sub> = 0 V, V <sub>DD±</sub> = ±2.5 V, V <sub>O</sub> = 0 V, R <sub>S</sub> = 50 Ω			0.002	μV/mo		
I <sub>IO</sub>	Input offset current	V <sub>IC</sub> = 0 V, V <sub>DD±</sub> = ±2.5 V, V <sub>O</sub> = 0 V, R <sub>S</sub> = 50 Ω	All level parts	T <sub>A</sub> = 25°C	0.5	60	pA	
			C level part	T <sub>A</sub> = 0°C to 80°C		100		
			I level part	T <sub>A</sub> = -40°C to 85°C		150		
			Q level part	T <sub>A</sub> = -40°C to 125°C		800		
			M level part	T <sub>A</sub> = -55°C to 125°C		800		
I <sub>IB</sub>	Input bias current	V <sub>IC</sub> = 0 V, V <sub>DD±</sub> = ±2.5 V, V <sub>O</sub> = 0 V, R <sub>S</sub> = 50 Ω	All level parts	T <sub>A</sub> = 25°C	1	60	pA	
			C level part	T <sub>A</sub> = 0°C to 80°C		100		
			I level part	T <sub>A</sub> = -40°C to 85°C		150		
			Q level part	T <sub>A</sub> = -40°C to 125°C		800		
			M level part	T <sub>A</sub> = -55°C to 125°C		800		
V <sub>ICR</sub>	Common-mode input voltage	R <sub>S</sub> = 50 Ω;  V <sub>IO</sub>   ≤ 5 mV	T <sub>A</sub> = 25°C		-0.3	2.5	4	V
			Full Range <sup>(1)</sup>			0	2.5	

(1) T<sub>A</sub> = -55°C to 125°C.

(2) Typical values are based on the input offset voltage shift observed through 168 hours of operating life test at T<sub>A</sub> = 150°C extrapolated to T<sub>A</sub> = 25°C using the Arrhenius equation and assuming an activation energy of 0.96 eV.

**TLC2272 and TLC2272A Electrical Characteristics  $V_{DD} = 5\text{ V}$  (continued)**

 at specified free-air temperature,  $V_{DD} = 5\text{ V}$ ;  $T_A = 25^\circ\text{C}$ , unless otherwise noted.

PARAMETER		TEST CONDITIONS		MIN	TYP	MAX	UNIT	
$V_{OH}$	High-level output voltage	$I_{OH} = -20\ \mu\text{A}$			4.99		V	
		$I_{OH} = -200\ \mu\text{A}$	$T_A = 25^\circ\text{C}$	4.85	4.93			
			Full Range <sup>(1)</sup>	4.85				
		$I_{OH} = -1\ \text{mA}$	$T_A = 25^\circ\text{C}$	4.25	4.65			
Full Range <sup>(1)</sup>	4.25							
$V_{OL}$	Low-level output voltage	$V_{IC} = 2.5\ \text{V}$	$I_{OL} = 50\ \mu\text{A}$		0.01		V	
			$I_{OL} = 500\ \mu\text{A}$	$T_A = 25^\circ\text{C}$		0.09		0.15
				Full Range <sup>(1)</sup>				0.15
			$I_{OL} = 5\ \text{mA}$	$T_A = 25^\circ\text{C}$		0.9		1.5
Full Range <sup>(1)</sup>				1.5				
$A_{VD}$	Large-signal differential voltage amplification	$V_{IC} = 2.5\ \text{V}$ , $V_O = 1\ \text{V to } 4\ \text{V}$ ; $R_L = 10\ \text{k}\Omega^{(3)}$	C level part	$T_A = 25^\circ\text{C}$	15	35	V/mV	
				$T_A = 0^\circ\text{C to } 80^\circ\text{C}$	15			
			I level part	$T_A = 25^\circ\text{C}$	15	35		
				$T_A = -40^\circ\text{C to } 85^\circ\text{C}$	15			
			Q level part	$T_A = 25^\circ\text{C}$	10	35		
				$T_A = -40^\circ\text{C to } 125^\circ\text{C}$	10			
			M level part	$T_A = 25^\circ\text{C}$	10	35		
$T_A = -55^\circ\text{C to } 125^\circ\text{C}$	10							
		$V_{IC} = 2.5\ \text{V}$ , $V_O = 1\ \text{V to } 4\ \text{V}$ ; $R_L = 1\ \text{M}\Omega^{(3)}$			175			
$r_{id}$	Differential input resistance				$10^{12}$		$\Omega$	
$r_i$	Common-mode input resistance				$10^{12}$		$\Omega$	
$c_i$	Common-mode input capacitance	$f = 10\ \text{kHz}$ , P package			8		pF	
$z_o$	Closed-loop output impedance	$f = 1\ \text{MHz}$ , $A_V = 10$			140		$\Omega$	
CMRR	Common-mode rejection ratio	$V_{IC} = 0\ \text{V to } 2.7\ \text{V}$ , $V_O = 2.5\ \text{V}$ , $R_S = 50\ \Omega$	$T_A = 25^\circ\text{C}$	70	75		dB	
			Full Range <sup>(1)</sup>	70				
$k_{SVR}$	Supply-voltage rejection ratio ( $\Delta V_{DD} / \Delta V_{IO}$ )	$V_{DD} = 4.4\ \text{V to } 16\ \text{V}$ , $V_{IC} = V_{DD} / 2$ , no load	$T_A = 25^\circ\text{C}$	80	95		dB	
			Full Range <sup>(1)</sup>	80				
$I_{DD}$	Supply current	$V_O = 2.5\ \text{V}$ , no load	$T_A = 25^\circ\text{C}$		2.2	3	mA	
			Full Range <sup>(1)</sup>			3		
SR	Slew rate at unity gain	$V_O = 0.5\ \text{V to } 2.5\ \text{V}$ , $R_L = 10\ \text{k}\Omega^{(3)}$ , $C_L = 100\ \text{pF}^{(3)}$	$T_A = 25^\circ\text{C}$	2.3	3.6		V/ $\mu\text{s}$	
			Full Range <sup>(1)</sup>	1.7				
$V_n$	Equivalent input noise voltage	$f = 10\ \text{Hz}$ $f = 1\ \text{kHz}$			50		nV/ $\sqrt{\text{Hz}}$	
					9			
$V_{NPP}$	Peak-to-peak equivalent input noise voltage	$f = 0.1\ \text{Hz to } 1\ \text{Hz}$ $f = 0.1\ \text{Hz to } 10\ \text{Hz}$			1		$\mu\text{V}$	
					1.4			
$I_n$	Equivalent input noise current				0.6		fA/ $\sqrt{\text{Hz}}$	
THD+N	Total harmonic distortion + noise	$V_O = 0.5\ \text{V to } 2.5\ \text{V}$ , $f = 20\ \text{kHz}$ , $R_L = 10\ \text{k}\Omega^{(3)}$	$A_V = 1$		0.0013%			
			$A_V = 10$		0.004%			
			$A_V = 100$		0.03%			
Gain-bandwidth product		$f = 10\ \text{kHz}$ , $R_L = 10\ \text{k}\Omega^{(3)}$ , $C_L = 100\ \text{pF}^{(3)}$			2.18		MHz	
$B_{OM}$	Maximum output-swing bandwidth	$V_{O(PP)} = 2\ \text{V}$ , $A_V = 1$ , $R_L = 10\ \text{k}\Omega^{(3)}$ , $C_L = 100\ \text{pF}^{(3)}$			1		MHz	
$t_s$	Settling time	$A_V = -1$ , $R_L = 10\ \text{k}\Omega^{(3)}$ , Step = $0.5\ \text{V to } 2.5\ \text{V}$ , $C_L = 100\ \text{pF}^{(3)}$	To 0.1%		1.5		$\mu\text{s}$	
			To 0.01%		2.6			
$\Phi_m$	Phase margin at unity gain	$R_L = 10\ \text{k}\Omega^{(3)}$ , $C_L = 100\ \text{pF}^{(3)}$			50°			
Gain margin		$R_L = 10\ \text{k}\Omega^{(3)}$ , $C_L = 100\ \text{pF}^{(3)}$			10		dB	

(3) Referenced to 0 V.

## 6.6 TLC2272 and TLC2272A Electrical Characteristics $V_{DD\pm} = \pm 5\text{ V}$

at specified free-air temperature,  $V_{DD\pm} = \pm 5\text{ V}$ ;  $T_A = 25^\circ\text{C}$ , unless otherwise noted.

PARAMETER		TEST CONDITIONS		MIN	TYP	MAX	UNIT	
$V_{IO}$	Input offset voltage	$V_{IC} = 0\text{ V}$ , $V_O = 0\text{ V}$ , $R_S = 50\ \Omega$	TLC2272	$T_A = 25^\circ\text{C}$	300	2500	$\mu\text{V}$	
			TLC2272A		300	950		
			TLC2272	Full Range <sup>(1)</sup>	3000			
			TLC2272A		1500			
$\alpha_{VIO}$	Temperature coefficient of input offset voltage	$V_{IC} = 0\text{ V}$ , $V_O = 0\text{ V}$ , $R_S = 50\ \Omega$			2		$\mu\text{V}/^\circ\text{C}$	
	Input offset voltage long-term drift <sup>(2)</sup>	$V_{IC} = 0\text{ V}$ , $V_O = 0\text{ V}$ , $R_S = 50\ \Omega$			0.002		$\mu\text{V}/\text{mo}$	
$I_{IO}$	Input offset current	$V_{IC} = 0\text{ V}$ , $V_O = 0\text{ V}$ , $R_S = 50\ \Omega$	All level parts	$T_A = 25^\circ\text{C}$	0.5	60	$\text{pA}$	
			C level part	$T_A = 0^\circ\text{C}$ to $80^\circ\text{C}$	100			
			I level part	$T_A = -40^\circ\text{C}$ to $85^\circ\text{C}$	150			
			Q level part	$T_A = -40^\circ\text{C}$ to $125^\circ\text{C}$	800			
			M level part	$T_A = -55^\circ\text{C}$ to $125^\circ\text{C}$	800			
$I_{IB}$	Input bias current	$V_{IC} = 0\text{ V}$ , $V_O = 0\text{ V}$ , $R_S = 50\ \Omega$	All level parts	$T_A = 25^\circ\text{C}$	1	60	$\text{pA}$	
			C level part	$T_A = 0^\circ\text{C}$ to $80^\circ\text{C}$	100			
			I level part	$T_A = -40^\circ\text{C}$ to $85^\circ\text{C}$	150			
			Q level part	$T_A = -40^\circ\text{C}$ to $125^\circ\text{C}$	800			
			M level part	$T_A = -55^\circ\text{C}$ to $125^\circ\text{C}$	800			
$V_{ICR}$	Common-mode input voltage	$R_S = 50\ \Omega$ ; $ V_{IO}  \leq 5\text{ mV}$		$T_A = 25^\circ\text{C}$	-5.3	0	4	V
				Full Range <sup>(1)</sup>	-5	0	3.5	
$V_{OM+}$	Maximum positive peak output voltage	$I_O = -20\ \mu\text{A}$		$T_A = 25^\circ\text{C}$	4.85	4.93	V	
				Full Range <sup>(1)</sup>	4.85			
				$T_A = 25^\circ\text{C}$	4.25	4.65		
				Full Range <sup>(1)</sup>	4.25			
$V_{OM-}$	Maximum negative peak output voltage	$V_{IC} = 0\text{ V}$ ,	$I_O = 50\ \mu\text{A}$		-4.99		V	
			$I_O = 500\ \mu\text{A}$	$T_A = 25^\circ\text{C}$	-4.85	-4.91		
				Full Range <sup>(1)</sup>	-4.85			
			$I_O = 5\text{ mA}$	$T_A = 25^\circ\text{C}$	-3.5	-4.1		
Full Range <sup>(1)</sup>	-3.5							
$A_{VD}$	Large-signal differential voltage amplification	$V_O = \pm 4\text{ V}$ ; $R_L = 10\text{ k}\Omega$	C level part	$T_A = 25^\circ\text{C}$	25	50	V/mV	
				$T_A = 0^\circ\text{C}$ to $80^\circ\text{C}$	25			
			I level part	$T_A = 25^\circ\text{C}$	25	50		
				$T_A = -40^\circ\text{C}$ to $85^\circ\text{C}$	25			
			Q level part	$T_A = 25^\circ\text{C}$	20	50		
				$T_A = -40^\circ\text{C}$ to $125^\circ\text{C}$	20			
			M level part	$T_A = 25^\circ\text{C}$	20	50		
$T_A = -55^\circ\text{C}$ to $125^\circ\text{C}$	20							
		$V_O = \pm 4\text{ V}$ ; $R_L = 1\text{ M}\Omega$			300			
$r_{id}$	Differential input resistance				$10^{12}$		$\Omega$	
$r_i$	Common-mode input resistance				$10^{12}$		$\Omega$	
$c_i$	Common-mode input capacitance	$f = 10\text{ kHz}$ , P package			8		pF	
$z_o$	Closed-loop output impedance	$f = 1\text{ MHz}$ , $A_V = 10$			130		$\Omega$	
CMRR	Common-mode rejection ratio	$V_{IC} = -5\text{ V}$ to $2.7\text{ V}$ , $V_O = 0\text{ V}$ , $R_S = 50\ \Omega$		$T_A = 25^\circ\text{C}$	75	80	dB	
				Full Range <sup>(1)</sup>	75			
$k_{SVR}$	Supply-voltage rejection ratio ( $\Delta V_{DD} / \Delta V_{IO}$ )	$V_{DD\pm} = 2.2\text{ V}$ to $\pm 8\text{ V}$ , $V_{IC} = 0\text{ V}$ , no load		$T_A = 25^\circ\text{C}$	80	95	dB	
				Full Range <sup>(1)</sup>	80			
$I_{DD}$	Supply current	$V_O = 0\text{ V}$ , no load		$T_A = 25^\circ\text{C}$	2.4	3	mA	
				Full Range <sup>(1)</sup>	3			

(1)  $T_A = -55^\circ\text{C}$  to  $125^\circ\text{C}$ .

(2) Typical values are based on the input offset voltage shift observed through 168 hours of operating life test at  $T_A = 150^\circ\text{C}$  extrapolated to  $T_A = 25^\circ\text{C}$  using the Arrhenius equation and assuming an activation energy of 0.96 eV.

## TLC2272 and TLC2272A Electrical Characteristics $V_{DD\pm} = \pm 5\text{ V}$ (continued)

 at specified free-air temperature,  $V_{DD\pm} = \pm 5\text{ V}$ ;  $T_A = 25^\circ\text{C}$ , unless otherwise noted.

PARAMETER		TEST CONDITIONS		MIN	TYP	MAX	UNIT
SR	Slew rate at unity gain	$V_O = \pm 2.3\text{ V}$ , $R_L = 10\text{ k}\Omega$ , $C_L = 100\text{ pF}$	$T_A = 25^\circ\text{C}$	2.3	3.6		V/ $\mu\text{s}$
			Full Range <sup>(1)</sup>	1.7			
$V_n$	Equivalent input noise voltage		$f = 10\text{ Hz}$		50		nV/ $\sqrt{\text{Hz}}$
			$f = 1\text{ kHz}$		9		
$V_{NPP}$	Peak-to-peak equivalent input noise voltage		$f = 0.1\text{ Hz to }1\text{ Hz}$		1		$\mu\text{V}$
			$f = 0.1\text{ Hz to }10\text{ Hz}$		1.4		
$I_n$	Equivalent input noise current				0.6		fA/ $\sqrt{\text{Hz}}$
THD+N	Total harmonic distortion + noise	$V_O = \pm 2.3$ , $f = 20\text{ kHz}$ , $R_L = 10\text{ k}\Omega$	$A_V = 1$		0.0011%		
			$A_V = 10$		0.004%		
			$A_V = 100$		0.03%		
	Gain-bandwidth product	$f = 10\text{ kHz}$ , $R_L = 10\text{ k}\Omega$ , $C_L = 100\text{ pF}$			2.25		MHz
$B_{OM}$	Maximum output-swing bandwidth	$V_{O(PP)} = 4.6\text{ V}$ , $A_V = 1$ , $R_L = 10\text{ k}\Omega$ , $C_L = 100\text{ pF}$			0.54		MHz
$t_s$	Settling time	$A_V = -1$ , $R_L = 10\text{ k}\Omega$ , Step = $-2.3\text{ V to }2.3\text{ V}$ , $C_L = 100\text{ pF}$	$T_O = 0.1\%$		1.5		$\mu\text{s}$
			$T_O = 0.01\%$		3.2		
$\phi_m$	Phase margin at unity gain	$R_L = 10\text{ k}\Omega$ , $C_L = 100\text{ pF}$			52°		
	Gain margin	$R_L = 10\text{ k}\Omega$ , $C_L = 100\text{ pF}$			10		dB

## 6.7 TLC2274 and TLC2274A Electrical Characteristics $V_{DD} = 5\text{ V}$

 at specified free-air temperature,  $V_{DD} = 5\text{ V}$ ;  $T_A = 25^\circ\text{C}$ , unless otherwise noted.

PARAMETER		TEST CONDITIONS		MIN	TYP	MAX	UNIT	
$V_{IO}$	Input offset voltage	$V_{IC} = 0\text{ V}$ , $V_{DD\pm} = \pm 2.5\text{ V}$ , $V_O = 0\text{ V}$ , $R_S = 50\ \Omega$	TLC2274	$T_A = 25^\circ\text{C}$	300	2500	$\mu\text{V}$	
			TLC2274A		300	950		
			TLC2274	Full Range <sup>(1)</sup>				3000
			TLC2274A					1500
$\alpha_{VIO}$	Temperature coefficient of input offset voltage	$V_{IC} = 0\text{ V}$ , $V_{DD\pm} = \pm 2.5\text{ V}$ , $V_O = 0\text{ V}$ , $R_S = 50\ \Omega$			2		$\mu\text{V}/^\circ\text{C}$	
	Input offset voltage long-term drift <sup>(2)</sup>	$V_{IC} = 0\text{ V}$ , $V_{DD\pm} = \pm 2.5\text{ V}$ , $V_O = 0\text{ V}$ , $R_S = 50\ \Omega$			0.002		$\mu\text{V}/\text{mo}$	
$I_{IO}$	Input offset current	$V_{IC} = 0\text{ V}$ , $V_{DD\pm} = \pm 2.5\text{ V}$ , $V_O = 0\text{ V}$ , $R_S = 50\ \Omega$	All level parts	$T_A = 25^\circ\text{C}$	0.5	60	$\text{pA}$	
			C level part	$T_A = 0^\circ\text{C to }80^\circ\text{C}$		100		
			I level part	$T_A = -40^\circ\text{C to }85^\circ\text{C}$		150		
			Q level part	$T_A = -40^\circ\text{C to }125^\circ\text{C}$		800		
			M level part	$T_A = -55^\circ\text{C to }125^\circ\text{C}$		800		
$I_{IB}$	Input bias current	$V_{IC} = 0\text{ V}$ , $V_{DD\pm} = \pm 2.5\text{ V}$ , $V_O = 0\text{ V}$ , $R_S = 50\ \Omega$	All level parts	$T_A = 25^\circ\text{C}$	1	60	$\text{pA}$	
			C level part	$T_A = 0^\circ\text{C to }80^\circ\text{C}$		100		
			I level part	$T_A = -40^\circ\text{C to }85^\circ\text{C}$		150		
			Q level part	$T_A = -40^\circ\text{C to }125^\circ\text{C}$		800		
			M level part	$T_A = -55^\circ\text{C to }125^\circ\text{C}$		800		
$V_{ICR}$	Common-mode input voltage	$R_S = 50\ \Omega$ ; $ V_{IO}  \leq 5\text{ mV}$	$T_A = 25^\circ\text{C}$	-0.3	2.5	4	V	
			Full Range <sup>(1)</sup>	0	2.5	3.5		
$V_{OH}$	High-level output voltage	$I_{OH} = -20\ \mu\text{A}$			4.99		V	
			$T_A = 25^\circ\text{C}$	4.85	4.93			
			Full Range <sup>(1)</sup>	4.85				
			$T_A = 25^\circ\text{C}$	4.25	4.65			
		$I_{OH} = -1\text{ mA}$			4.25			

 (1)  $T_A = -55^\circ\text{C to }125^\circ\text{C}$ .

 (2) Typical values are based on the input offset voltage shift observed through 168 hours of operating life test at  $T_A = 150^\circ\text{C}$  extrapolated to  $T_A = 25^\circ\text{C}$  using the Arrhenius equation and assuming an activation energy of 0.96 eV.

## TLC2274 and TLC2274A Electrical Characteristics $V_{DD} = 5\text{ V}$ (continued)

at specified free-air temperature,  $V_{DD} = 5\text{ V}$ ;  $T_A = 25^\circ\text{C}$ , unless otherwise noted.

PARAMETER		TEST CONDITIONS		MIN	TYP	MAX	UNIT	
$V_{OL}$	Low-level output voltage	$V_{IC} = 2.5\text{ V}$	$I_{OL} = 50\ \mu\text{A}$		0.01		V	
			$I_{OL} = 500\ \mu\text{A}$	$T_A = 25^\circ\text{C}$		0.09		0.15
				Full Range <sup>(1)</sup>				0.15
			$I_{OL} = 5\text{ mA}$	$T_A = 25^\circ\text{C}$		0.9		1.5
Full Range <sup>(1)</sup>				1.5				
$A_{VD}$	Large-signal differential voltage amplification	$V_{IC} = 2.5\text{ V}$ , $V_O = 1\text{ V}$ to $4\text{ V}$ ; $R_L = 10\text{ k}\Omega$ <sup>(3)</sup>	C level part	$T_A = 25^\circ\text{C}$	15	35	V/mV	
				$T_A = 0^\circ\text{C}$ to $80^\circ\text{C}$	15			
			I level part	$T_A = 25^\circ\text{C}$	15	35		
				$T_A = -40^\circ\text{C}$ to $85^\circ\text{C}$	15			
			Q level part	$T_A = 25^\circ\text{C}$	10	35		
				$T_A = -40^\circ\text{C}$ to $125^\circ\text{C}$	10			
			M level part	$T_A = 25^\circ\text{C}$	10	35		
	$T_A = -55^\circ\text{C}$ to $125^\circ\text{C}$	10						
	$V_{IC} = 2.5\text{ V}$ , $V_O = 1\text{ V}$ to $4\text{ V}$ ; $R_L = 1\text{ M}\Omega$ <sup>(3)</sup>		175					
$r_{id}$	Differential input resistance			$10^{12}$		$\Omega$		
$r_i$	Common-mode input resistance			$10^{12}$		$\Omega$		
$c_i$	Common-mode input capacitance	$f = 10\text{ kHz}$ , P package			8	pF		
$z_o$	Closed-loop output impedance	$f = 1\text{ MHz}$ , $A_V = 10$			140	$\Omega$		
CMRR	Common-mode rejection ratio	$V_{IC} = 0\text{ V}$ to $2.7\text{ V}$ , $V_O = 2.5\text{ V}$ , $R_S = 50\ \Omega$	$T_A = 25^\circ\text{C}$	70	75	dB		
			Full Range <sup>(1)</sup>	70				
$k_{SVR}$	Supply-voltage rejection ratio ( $\Delta V_{DD} / \Delta V_{IO}$ )	$V_{DD} = 4.4\text{ V}$ to $16\text{ V}$ , $V_{IC} = V_{DD} / 2$ , no load	$T_A = 25^\circ\text{C}$	80	95	dB		
			Full Range <sup>(1)</sup>	80				
$I_{DD}$	Supply current	$V_O = 2.5\text{ V}$ , no load	$T_A = 25^\circ\text{C}$		4.4	6	mA	
			Full Range <sup>(1)</sup>			6		
SR	Slew rate at unity gain	$V_O = 0.5\text{ V}$ to $2.5\text{ V}$ , $R_L = 10\text{ k}\Omega$ <sup>(3)</sup> , $C_L = 100\text{ pF}$ <sup>(3)</sup>	$T_A = 25^\circ\text{C}$	2.3	3.6	V/ $\mu\text{s}$		
			Full Range <sup>(1)</sup>	1.7				
$V_n$	Equivalent input noise voltage	$f = 10\text{ Hz}$			50	nV/ $\sqrt{\text{Hz}}$		
		$f = 1\text{ kHz}$			9			
$V_{NPP}$	Peak-to-peak equivalent input noise voltage	$f = 0.1\text{ Hz}$ to $1\text{ Hz}$			1	$\mu\text{V}$		
		$f = 0.1\text{ Hz}$ to $10\text{ Hz}$			1.4			
$I_n$	Equivalent input noise current				0.6	fA/ $\sqrt{\text{Hz}}$		
THD+N	Total harmonic distortion + noise	$V_O = 0.5\text{ V}$ to $2.5\text{ V}$ , $f = 20\text{ kHz}$ , $R_L = 10\text{ k}\Omega$ <sup>(3)</sup>	$A_V = 1$		0.0013%			
			$A_V = 10$		0.004%			
			$A_V = 100$		0.03%			
	Gain-bandwidth product	$f = 10\text{ kHz}$ , $R_L = 10\text{ k}\Omega$ <sup>(3)</sup> , $C_L = 100\text{ pF}$ <sup>(3)</sup>			2.18	MHz		
$B_{OM}$	Maximum output-swing bandwidth	$V_{O(PP)} = 2\text{ V}$ , $A_V = 1$ , $R_L = 10\text{ k}\Omega$ <sup>(3)</sup> , $C_L = 100\text{ pF}$ <sup>(3)</sup>			1	MHz		
$t_s$	Settling time	$A_V = -1$ , $R_L = 10\text{ k}\Omega$ <sup>(3)</sup> , Step = $0.5\text{ V}$ to $2.5\text{ V}$ , $C_L = 100\text{ pF}$ <sup>(3)</sup>	$T_O = 0.1\%$		1.5	$\mu\text{s}$		
			$T_O = 0.01\%$		2.6			
$\Phi_m$	Phase margin at unity gain	$R_L = 10\text{ k}\Omega$ <sup>(3)</sup> , $C_L = 100\text{ pF}$ <sup>(3)</sup>			50°			
	Gain margin	$R_L = 10\text{ k}\Omega$ <sup>(3)</sup> , $C_L = 100\text{ pF}$ <sup>(3)</sup>			10	dB		

(3) Referenced to 0 V.

## 6.8 TLC2274 and TLC2274A Electrical Characteristics $V_{DD\pm} = \pm 5\text{ V}$

 at specified free-air temperature,  $V_{DD\pm} = \pm 5\text{ V}$ ;  $T_A = 25^\circ\text{C}$ , unless otherwise noted.

PARAMETER		TEST CONDITIONS		MIN	TYP	MAX	UNIT	
$V_{IO}$	Input offset voltage	$V_{IC} = 0\text{ V}$ , $V_O = 0\text{ V}$ , $R_S = 50\ \Omega$	TLC2274	$T_A = 25^\circ\text{C}$	300	2500	$\mu\text{V}$	
			TLC2274A		300	950		
			TLC2274	Full Range <sup>(1)</sup>	3000			
			TLC2274A		1500			
$\alpha_{VIO}$	Temperature coefficient of input offset voltage	$V_{IC} = 0\text{ V}$ , $V_O = 0\text{ V}$ , $R_S = 50\ \Omega$			2		$\mu\text{V}/^\circ\text{C}$	
	Input offset voltage long-term drift <sup>(2)</sup>	$V_{IC} = 0\text{ V}$ , $V_O = 0\text{ V}$ , $R_S = 50\ \Omega$			0.002		$\mu\text{V}/\text{mo}$	
$I_{IO}$	Input offset current	$V_{IC} = 0\text{ V}$ , $V_O = 0\text{ V}$ , $R_S = 50\ \Omega$	All level parts	$T_A = 25^\circ\text{C}$	0.5	60	$\text{pA}$	
			C level part	$T_A = 0^\circ\text{C}$ to $80^\circ\text{C}$	100			
			I level part	$T_A = -40^\circ\text{C}$ to $85^\circ\text{C}$	150			
			Q level part	$T_A = -40^\circ\text{C}$ to $125^\circ\text{C}$	800			
			M level part	$T_A = -55^\circ\text{C}$ to $125^\circ\text{C}$	800			
$I_{IB}$	Input bias current	$V_{IC} = 0\text{ V}$ , $V_O = 0\text{ V}$ , $R_S = 50\ \Omega$	All level parts	$T_A = 25^\circ\text{C}$	1	60	$\text{pA}$	
			C level part	$T_A = 0^\circ\text{C}$ to $80^\circ\text{C}$	100			
			I level part	$T_A = -40^\circ\text{C}$ to $85^\circ\text{C}$	150			
			Q level part	$T_A = -40^\circ\text{C}$ to $125^\circ\text{C}$	800			
			M level part	$T_A = -55^\circ\text{C}$ to $125^\circ\text{C}$	800			
$V_{ICR}$	Common-mode input voltage	$R_S = 50\ \Omega$ ; $ V_{IO}  \leq 5\text{ mV}$	All level parts	$T_A = 25^\circ\text{C}$	-5.3	0	4	V
				Full Range <sup>(1)</sup>	-5	0	3.5	
$V_{OM+}$	Maximum positive peak output voltage	$I_O = -20\ \mu\text{A}$		$T_A = 25^\circ\text{C}$	4.85	4.93	V	
				Full Range <sup>(1)</sup>	4.85			
				$T_A = 25^\circ\text{C}$	4.25	4.65		
				Full Range <sup>(1)</sup>	4.25			
$V_{OM-}$	Maximum negative peak output voltage	$V_{IC} = 0\text{ V}$	$I_O = 50\ \mu\text{A}$	$T_A = 25^\circ\text{C}$	-4.85	-4.91	V	
				Full Range <sup>(1)</sup>	-4.85			
			$I_O = 5\text{ mA}$	$T_A = 25^\circ\text{C}$	-3.5	-4.1		
				Full Range <sup>(1)</sup>	-3.5			
$A_{VD}$	Large-signal differential voltage amplification	$V_O = \pm 4\text{ V}$ ; $R_L = 10\text{ k}\Omega$	C level part	$T_A = 25^\circ\text{C}$	25	50	V/mV	
				$T_A = 0^\circ\text{C}$ to $80^\circ\text{C}$	25			
			I level part	$T_A = 25^\circ\text{C}$	25	50		
				$T_A = -40^\circ\text{C}$ to $85^\circ\text{C}$	25			
			Q level part	$T_A = 25^\circ\text{C}$	20	50		
				$T_A = -40^\circ\text{C}$ to $125^\circ\text{C}$	20			
			M level part	$T_A = 25^\circ\text{C}$	20	50		
$T_A = -55^\circ\text{C}$ to $125^\circ\text{C}$	20							
		$V_O = \pm 4\text{ V}$ ; $R_L = 1\text{ M}\Omega$			300			
$r_{id}$	Differential input resistance				$10^{12}$		$\Omega$	
$r_i$	Common-mode input resistance				$10^{12}$		$\Omega$	
$c_i$	Common-mode input capacitance	$f = 10\text{ kHz}$ , P package			8		pF	
$z_o$	Closed-loop output impedance	$f = 1\text{ MHz}$ , $A_V = 10$			130		$\Omega$	
CMRR	Common-mode rejection ratio	$V_{IC} = -5\text{ V}$ to $2.7\text{ V}$ , $V_O = 0\text{ V}$ , $R_S = 50\ \Omega$	$T_A = 25^\circ\text{C}$	75	80	dB		
			Full Range <sup>(1)</sup>	75				
$k_{SVR}$	Supply-voltage rejection ratio ( $\Delta V_{DD} / \Delta V_{IO}$ )	$V_{DD\pm} = 2.2\text{ V}$ to $\pm 8\text{ V}$ , $V_{IC} = 0\text{ V}$ , no load	$T_A = 25^\circ\text{C}$	80	95	dB		
			Full Range <sup>(1)</sup>	80				
$I_{DD}$	Supply current	$V_O = 0\text{ V}$ , no load	$T_A = 25^\circ\text{C}$	4.8	6	mA		
			Full Range <sup>(1)</sup>	6				

 (1)  $T_A = -55^\circ\text{C}$  to  $125^\circ\text{C}$ .

 (2) Typical values are based on the input offset voltage shift observed through 168 hours of operating life test at  $T_A = 150^\circ\text{C}$  extrapolated to  $T_A = 25^\circ\text{C}$  using the Arrhenius equation and assuming an activation energy of 0.96 eV.

### TLC2274 and TLC2274A Electrical Characteristics $V_{DD\pm} = \pm 5\text{ V}$ (continued)

at specified free-air temperature,  $V_{DD\pm} = \pm 5\text{ V}$ ;  $T_A = 25^\circ\text{C}$ , unless otherwise noted.

PARAMETER		TEST CONDITIONS		MIN	TYP	MAX	UNIT
SR	Slew rate at unity gain	$V_O = \pm 2.3\text{ V}$ , $R_L = 10\text{ k}\Omega$ , $C_L = 100\text{ pF}$	$T_A = 25^\circ\text{C}$	2.3	3.6		V/ $\mu\text{s}$
			Full Range <sup>(1)</sup>	1.7			
$V_n$	Equivalent input noise voltage		$f = 10\text{ Hz}$		50		nV/ $\sqrt{\text{Hz}}$
			$f = 1\text{ kHz}$		9		
$V_{NPP}$	Peak-to-peak equivalent input noise voltage		$f = 0.1\text{ Hz to }1\text{ Hz}$		1		$\mu\text{V}$
			$f = 0.1\text{ Hz to }10\text{ Hz}$		1.4		
$I_n$	Equivalent input noise current				0.6		fA/ $\sqrt{\text{Hz}}$
THD+N	Total harmonic distortion + noise	$V_O = \pm 2.3$ , $f = 20\text{ kHz}$ , $R_L = 10\text{ k}\Omega$	$A_V = 1$		0.0011%		
			$A_V = 10$		0.004%		
			$A_V = 100$		0.03%		
	Gain-bandwidth product	$f = 10\text{ kHz}$ , $R_L = 10\text{ k}\Omega$ , $C_L = 100\text{ pF}$			2.25		MHz
$B_{OM}$	Maximum output-swing bandwidth	$V_{O(PP)} = 4.6\text{ V}$ , $A_V = 1$ , $R_L = 10\text{ k}\Omega$ , $C_L = 100\text{ pF}$			0.54		MHz
$t_s$	Settling time	$A_V = -1$ , $R_L = 10\text{ k}\Omega$ , Step = $-2.3\text{ V to }2.3\text{ V}$ , $C_L = 100\text{ pF}$	$T_o 0.1\%$		1.5		$\mu\text{s}$
			$T_o 0.01\%$		3.2		
$\Phi_m$	Phase margin at unity gain	$R_L = 10\text{ k}\Omega$ , $C_L = 100\text{ pF}$			52°		
	Gain margin	$R_L = 10\text{ k}\Omega$ , $C_L = 100\text{ pF}$			10		dB

## 6.9 Typical Characteristics

**Table 1. Table of Graphs**

			<b>FIGURE<sup>(1)</sup></b>
$V_{IO}$	Input offset voltage	Distribution	<a href="#">1, 2, 3, 4</a>
		vs Common-mode voltage	<a href="#">5, 6</a>
$\alpha_{VIO}$	Input offset voltage temperature coefficient	Distribution	<a href="#">7, 8, 9, 10<sup>(2)</sup></a>
$I_{IB} / I_{IO}$	Input bias and input offset current	vs Free-air temperature	<a href="#">11<sup>(2)</sup></a>
$V_I$	Input voltage	vs Supply voltage	<a href="#">12</a>
		vs Free-air temperature	<a href="#">13<sup>(2)</sup></a>
$V_{OH}$	High-level output voltage	vs High-level output current	<a href="#">14<sup>(2)</sup></a>
$V_{OL}$	Low-level output voltage	vs Low-level output current	<a href="#">15, 16<sup>(2)</sup></a>
$V_{OM+}$	Maximum positive peak output voltage	vs Output current	<a href="#">17<sup>(2)</sup></a>
$V_{OM-}$	Maximum negative peak output voltage	vs Output current	<a href="#">18<sup>(2)</sup></a>
$V_{O(PP)}$	Maximum peak-to-peak output voltage	vs Frequency	<a href="#">19</a>
$I_{OS}$	Short-circuit output current	vs Supply voltage	<a href="#">20</a>
		vs Free-air temperature	<a href="#">21<sup>(2)</sup></a>
$V_O$	Output voltage	vs Differential input voltage	<a href="#">22, 23</a>
$A_{VD}$	Large-signal differential voltage amplification	vs Load resistance	<a href="#">24</a>
	Large-signal differential voltage amplification and phase margin	vs Frequency	<a href="#">25, 26</a>
	Large-signal differential voltage amplification	vs Free-air temperature	<a href="#">27<sup>(2)</sup>, 28<sup>(2)</sup></a>
$z_0$	Output impedance	vs Frequency	<a href="#">29, 30</a>
CMRR	Common-mode rejection ratio	vs Frequency	<a href="#">31</a>
		vs Free-air temperature	<a href="#">32</a>
$k_{SVR}$	Supply-voltage rejection ratio	vs Frequency	<a href="#">33, 34</a>
		vs Free-air temperature	<a href="#">35<sup>(2)</sup></a>
$I_{DD}$	Supply current	vs Supply voltage	<a href="#">36<sup>(2)</sup>, 37<sup>(2)</sup></a>
		vs Free-air temperature	<a href="#">38<sup>(2)</sup>, 39<sup>(2)</sup></a>
SR	Slew rate	vs Load Capacitance	<a href="#">40</a>
		vs Free-air temperature	<a href="#">41<sup>(2)</sup></a>
$V_O$	Inverting large-signal pulse response		<a href="#">42, 43</a>
	Voltage-follower large-signal pulse response		<a href="#">44, 45</a>
	Inverting small-signal pulse response		<a href="#">46, 47</a>
	Voltage-follower small-signal pulse response		<a href="#">48, 49</a>
$V_n$	Equivalent input noise voltage	vs Frequency	<a href="#">50, 51</a>
	Noise voltage over a 10-second period		<a href="#">52</a>
	Integrated noise voltage	vs Frequency	<a href="#">53</a>
THD+N	Total harmonic distortion + noise	vs Frequency	<a href="#">54</a>
		Gain-bandwidth product	vs Supply voltage
		vs Free-air temperature	<a href="#">56<sup>(2)</sup></a>
$\Phi_m$	Phase margin	vs Load capacitance	<a href="#">57</a>
	Gain margin	vs Load capacitance	<a href="#">58</a>

(1) For all graphs where  $V_{DD} = 5\text{ V}$ , all loads are referenced to 2.5 V.

(2) Data at high and low temperatures are applicable only within the rated operating free-air temperature ranges of the various devices.



Figure 1. Distribution of TLC2272 Input Offset Voltage



Figure 2. Distribution of TLC2272 Input Offset Voltage

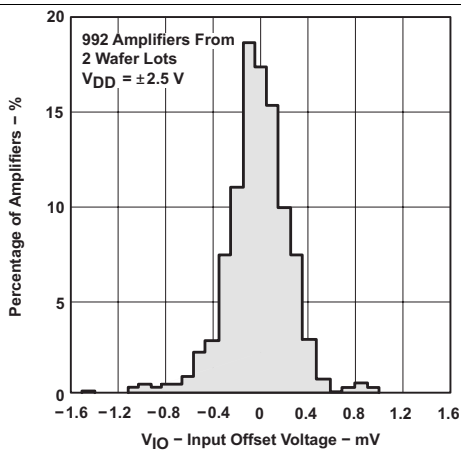

Figure 3. Distribution of TLC2274 Input Offset Voltage

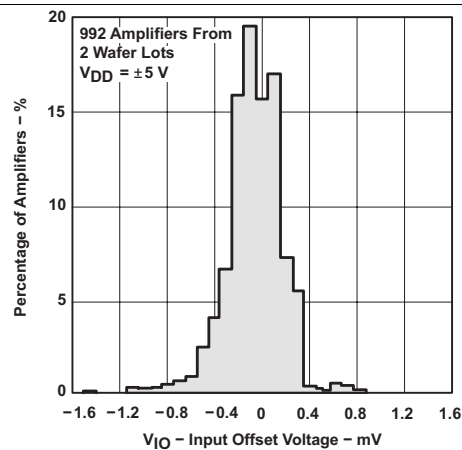

Figure 4. Distribution of TLC2274 Input Offset Voltage



Figure 5. Input Offset Voltage vs Common-Mode Voltage



Figure 6. Input Offset Voltage vs Common-Mode Voltage



Figure 7. Distribution of TLC2272 vs Input Offset Voltage Temperature Coefficient

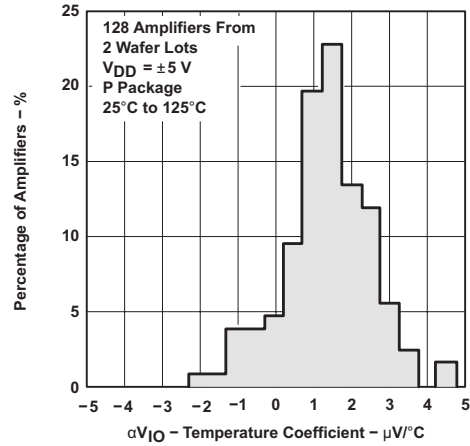

Figure 8. Distribution of TLC2272 vs Input Offset Voltage Temperature Coefficient

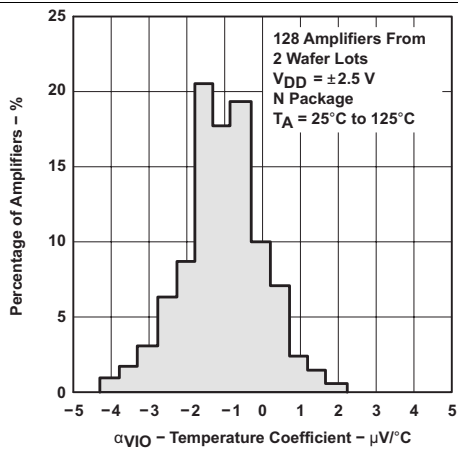

Figure 9. Distribution of TLC2274 vs Input Offset Voltage Temperature Coefficient

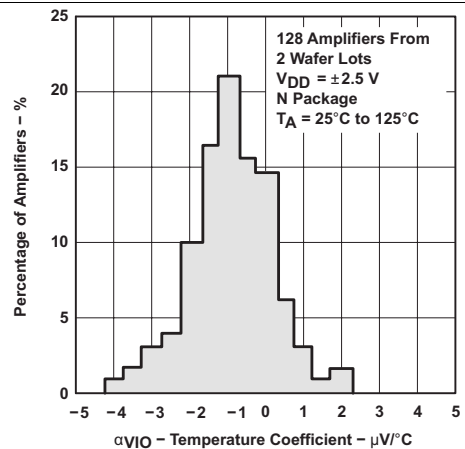

Figure 10. Distribution of TLC2274 vs Input Offset Voltage Temperature Coefficient

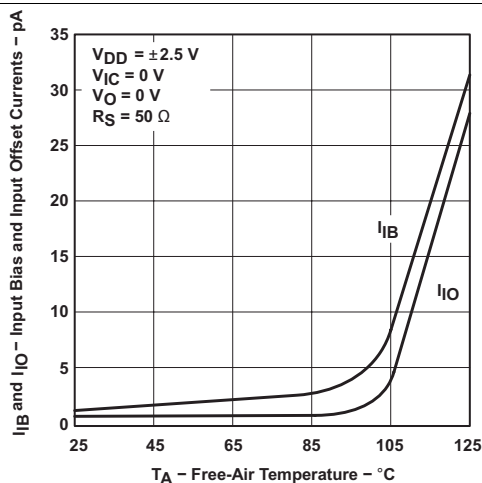

Figure 11. Input Bias and Input Offset Current vs Free-Air Temperature

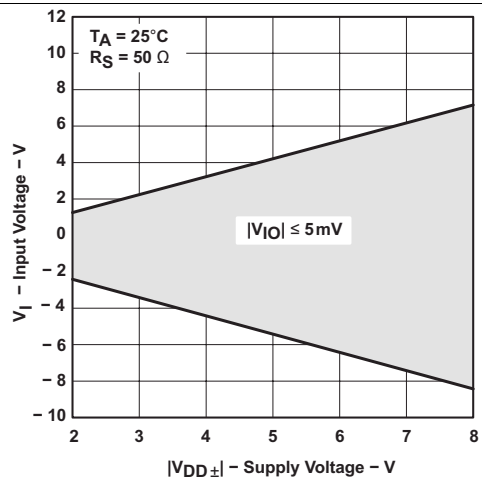

Figure 12. Input Voltage vs Supply Voltage



Figure 13. Input Voltage vs Free-Air Temperature

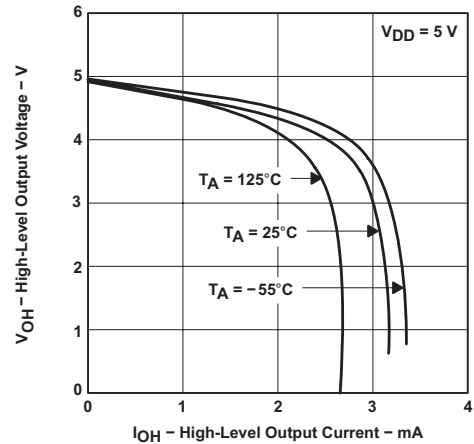

Figure 14. High-Level Output Voltage vs High-Level Output Current



Figure 15. Low-Level Output Voltage vs Low-Level Output Current

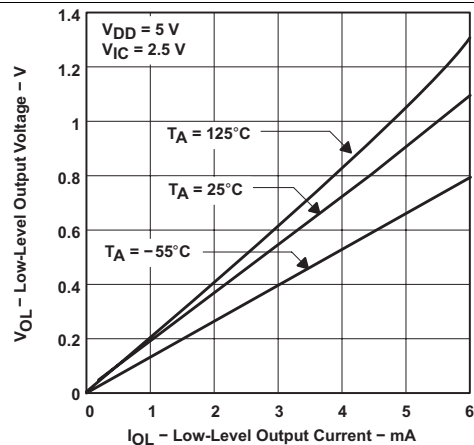

Figure 16. Low-Level Output Voltage vs Low-Level Output Current



Figure 17. Maximum Positive Peak Output Voltage vs Output Current

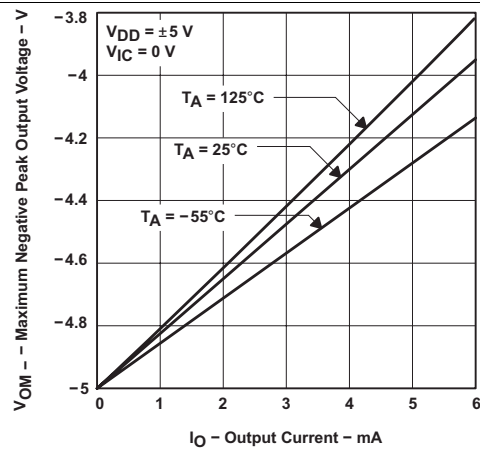

Figure 18. Maximum Positive Peak Output Voltage vs Output Current



Figure 19. Maximum Peak-to-Peak Output Voltage vs Frequency



Figure 20. Short-Circuit Output Current vs Supply Voltage



Figure 21. Short-Circuit Output Current vs Free-Air Temperature



Figure 22. Output Voltage vs Differential Input Voltage



Figure 23. Output Voltage vs Differential Input Voltage

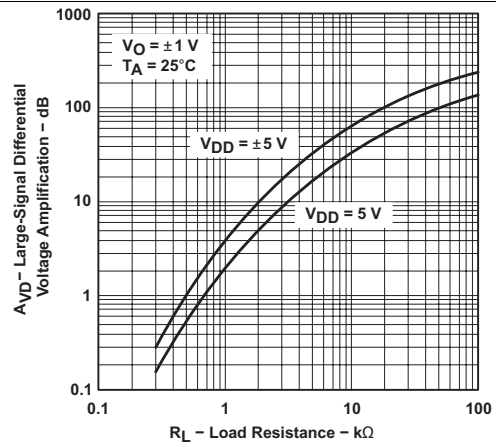

Figure 24. Large-Signal Differential Voltage Amplification vs Load Resistance

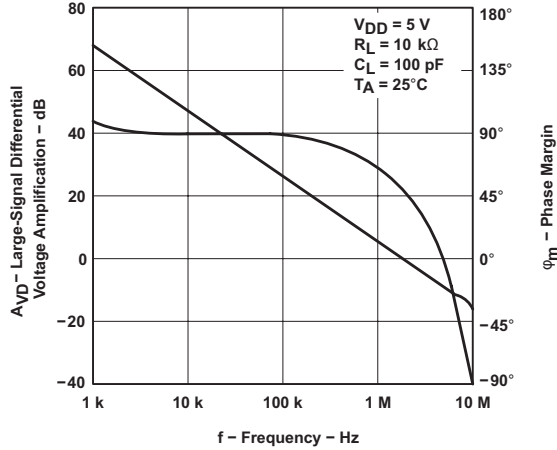

Figure 25. Large-Signal Differential Voltage Amplification and Phase Margin vs Frequency

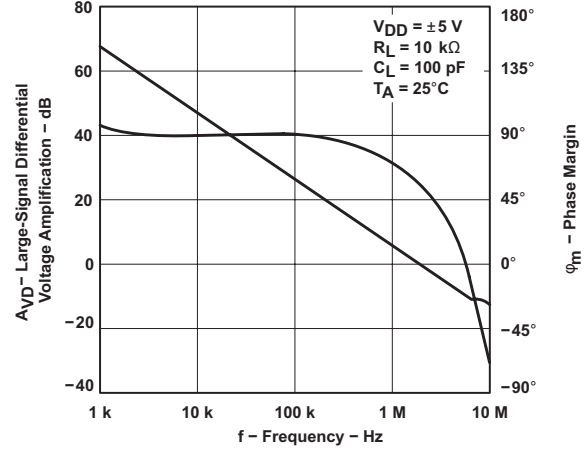

Figure 26. Large-Signal Differential Voltage Amplification and Phase Margin vs Frequency



Figure 27. Large-Signal Differential Voltage Amplification vs Free-Air Temperature



Figure 28. Large-Signal Differential Voltage Amplification vs Free-Air Temperature

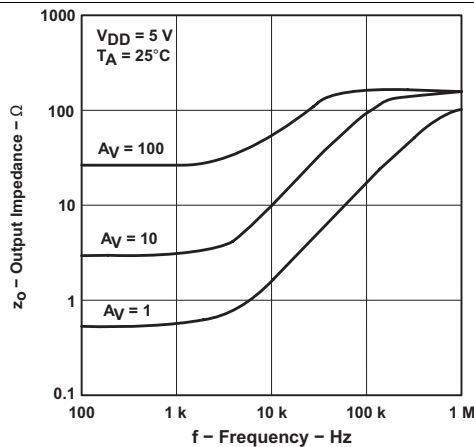

Figure 29. Output Impedance vs Frequency

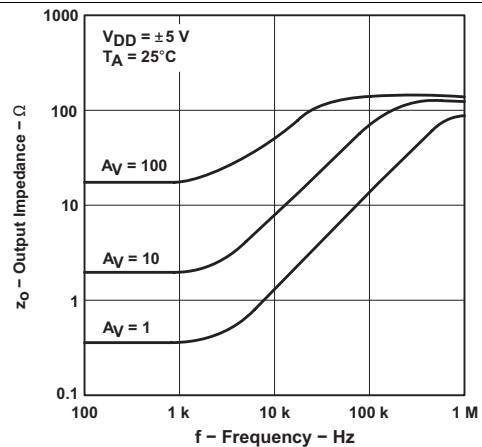

Figure 30. Output Impedance vs Frequency



Figure 31. Common-Mode Rejection Ratio vs Frequency



Figure 32. Common-Mode Rejection Ratio vs Free-Air Temperature



Figure 33. Supply-Voltage Rejection Ratio vs Frequency



Figure 34. Supply-Voltage Rejection Ratio vs Frequency



Figure 35. Supply-Voltage Rejection Ratio vs Free-Air Temperature



Figure 36. TLC2272 Supply Current vs Supply Voltage



Figure 37. TLC2274 Supply Current vs Supply Voltage



Figure 38. TLC2272 Supply Current vs Free-Air Temperature



Figure 39. TLC2274 Supply Current vs Free-Air Temperature



Figure 40. Slew Rate vs Load Capacitance



Figure 41. Slew Rate vs Free-Air Temperature



Figure 42. Inverting Large-Signal Pulse Response



Figure 43. Inverting Large-Signal Pulse Response



Figure 44. Voltage-Follower Large-Signal Pulse Response



Figure 45. Voltage-Follower Large-Signal Pulse Response



Figure 46. Inverting Small-Signal Pulse Response



Figure 47. Inverting Small-Signal Pulse Response



Figure 48. Voltage-Follower Small-Signal Pulse Response



Figure 49. Voltage-Follower Small-Signal Pulse Response



Figure 50. Equivalent Input Noise Voltage vs Frequency



Figure 51. Equivalent Input Noise Voltage vs Frequency



Figure 52. Noise Voltage Over a 10 Second Period



Figure 53. Integrated Noise Voltage vs Frequency



Figure 54. Total Harmonic Distortion + Noise vs Frequency

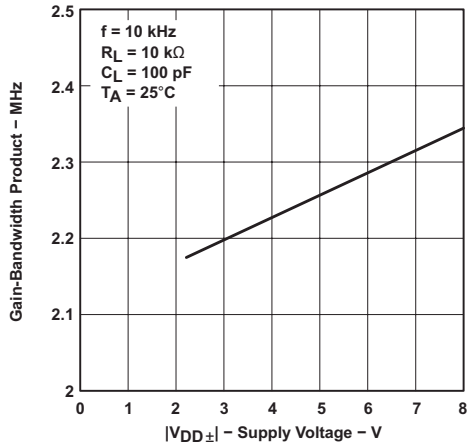

Figure 55. Gain-Bandwidth Product vs Supply Voltage

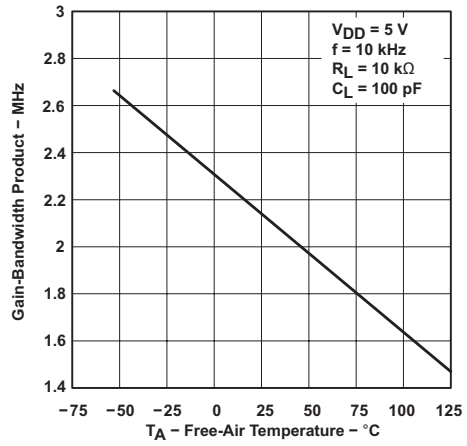

Figure 56. Gain-Bandwidth Product vs Free-Air Temperature

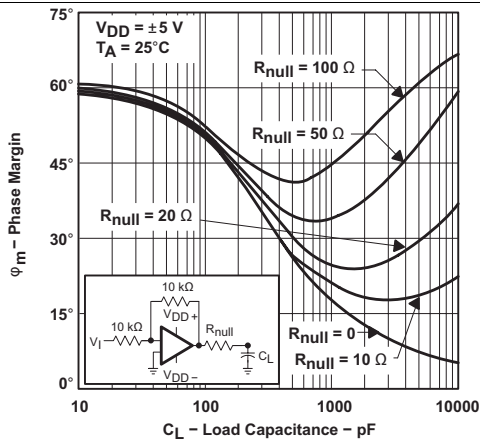

Figure 57. Phase Margin vs Load Capacitance

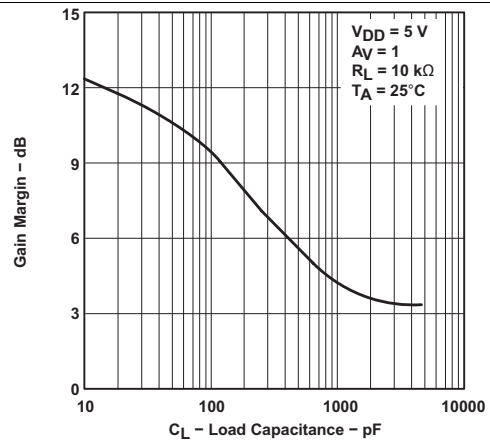

Figure 58. Gain Margin vs Load Capacitance

## 7 Detailed Description

### 7.1 Overview

The TLC227x and TLC227xA families of devices are rail-to-rail output operational amplifiers. These devices operate from 4.4-V to 16-V single supply and  $\pm 2.2$ -V  $\pm 8$ -V dual supply, are unity-gain stable, and are suitable for a wide range of general-purpose applications.

### 7.2 Functional Block Diagram



Table 2. Device Component Count<sup>(1)</sup>

Component	TLC2272	TLC2274
Transistors	38	76
Resistors	26	52
Diodes	9	18
Capacitors	3	6

(1) Includes both amplifiers and all ESD, bias, and trim circuitry.

### 7.3 Feature Description

The TLC227x and TLC227xA family of devices feature 2-MHz bandwidth and voltage noise of  $9 \text{ nV}/\sqrt{\text{Hz}}$  with performance rated from 4.4 V to 16 V across an automotive temperature range ( $-40^\circ\text{C}$  to  $125^\circ\text{C}$ ). LinMOS suits a wide range of audio, automotive, industrial, and instrumentation applications.

### 7.4 Device Functional Modes

The TLC227x and TLC227xA families of devices is powered on when the supply is connected. The devices may operate with single or dual supply, depending on the application. The devices are in its full performance once the supply is above the recommended value.

## 8 Application and Implementation

### NOTE

Information in the following applications sections is not part of the TI component specification, and TI does not warrant its accuracy or completeness. TI's customers are responsible for determining suitability of components for their purposes. Customers should validate and test their design implementation to confirm system functionality.

### 8.1 Application Information

#### 8.1.1 Macromodel Information

Macromodel information provided was derived using MicroSim Parts™, the model generation software used with MicroSim PSpice™. The Boyle macromodel <sup>(1)</sup> and subcircuit in Figure 59 were generated using the TLC227x typical electrical and operating characteristics at  $T_A = 25^\circ\text{C}$ . Using this information, output simulations of the following key parameters can be generated to a tolerance of 20% (in most cases):

- Maximum positive output voltage swing
- Maximum negative output voltage swing
- Slew rate
- Quiescent power dissipation
- Input bias current
- Open-loop voltage amplification
- Unity gain frequency
- Common-mode rejection ratio
- Phase margin
- DC output resistance
- AC output resistance
- Short-circuit output current limit



Figure 59. Boyle Macromodel and Subcircuit

(1) *Macromodeling of Integrated Circuit Operational Amplifiers*, IEEE Journal of Solid-State Circuits, SC-9, 353 (1974).

## 8.2 Typical Application

### 8.2.1 High-Side Current Monitor

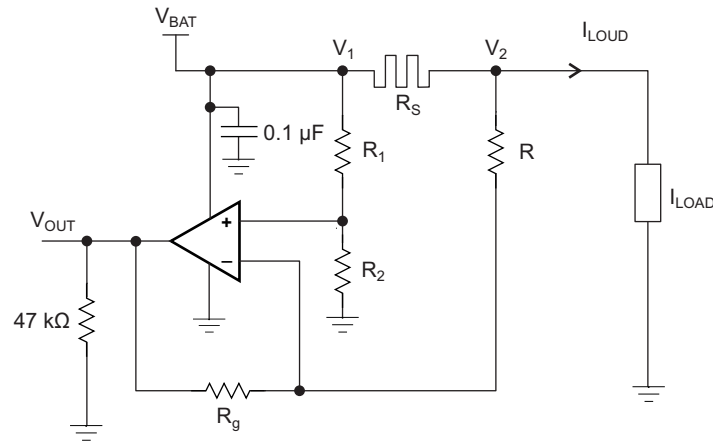

Figure 60. Equivalent Schematic (Each Amplifier)

#### 8.2.1.1 Design Requirements

For this design example, use the parameters listed in [Table 3](#) as the input parameters.

Table 3. Design Parameters

PARAMETER	VALUE
$V_{BAT}$	Battery Voltage 12 V
$R_{SENSE}$	Sense Resistor 0.1 $\Omega$
$I_{LOAD}$	Load Current 0 A to 10 A
Operational Amplifier	Set in Differential configuration with Gain = 10

#### 8.2.1.2 Detailed Design Procedure

This circuit is designed for measuring the high-side current in automotive body control modules with 12-V battery or similar applications. The operational amplifier is set as differential with an external resistor network.

##### 8.2.1.2.1 Differential Amplifier Equations

[Equation 1](#) and [Equation 2](#) are used to calculate  $V_{OUT}$ .

$$V_{OUT} = \frac{R_g}{R} \left( \frac{\frac{R}{R_g} - \frac{R_1}{R_2}}{1 + \frac{R_1}{R_2}} \times \frac{V_1 + V_2}{2} + \frac{1 + \frac{1}{2} \left( \frac{R_1}{R_2} + \frac{R}{R_g} \right)}{1 + \frac{R_1}{R_2}} (V_1 - V_2) \right) \quad (1)$$

$$V_{OUT} = \frac{R_g}{R} \left( \frac{\frac{R}{R_g} - \frac{R_1}{R_2}}{1 + \frac{R_1}{R_2}} \times V_{BAT} + \frac{1 + \frac{1}{2} \left( \frac{R_1}{R_2} + \frac{R}{R_g} \right)}{1 + \frac{R_1}{R_2}} \times R_S \times I_{Load} \right) \quad (2)$$

In an ideal case  $R_1 = R$  and  $R_2 = R_g$ , and  $V_{OUT}$  can then be calculated using [Equation 3](#):

$$V_{OUT} = \frac{R_g}{R} \times R_S \times I_{Load} \quad (3)$$

However, as the resistors have tolerances, they cannot be perfectly matched.

$$\begin{aligned}
 R_1 &= R \pm \Delta R_1 \\
 R_2 &= R_2 \pm \Delta R_2 \\
 R &= R \pm \Delta R \\
 R_g &= R_g \pm \Delta R_g \\
 \text{Tol} &= \frac{\Delta R}{R}
 \end{aligned} \tag{4}$$

By developing the equations and neglecting the second order, the worst case is when the tolerances add up. This is shown by [Equation 5](#).

$$V_{\text{OUT}} = \pm (4 \text{ Tol}) \frac{R_g}{R + R_g} \times V_{\text{BAT}} + \left( 1 \pm 2 \text{ Tol} \left( 1 + \frac{2R}{R + R_g} \right) \right) \frac{R_g}{R} \times R_S \times I_{\text{LOAD}}$$

where

- Tol = 0.01 for 1%
  - Tol = 0.001 for 0.1%
- (5)

If the resistors are perfectly matched, then Tol = 0 and  $V_{\text{OUT}}$  is calculated using [Equation 6](#).

$$V_{\text{OUT}} = \frac{R_g}{R} \times R_S \times I_{\text{LOAD}} \tag{6}$$

The highest error is from the Common mode, as shown in [Equation 7](#).

$$4 (\text{Tol}) \frac{R_g}{R + R_g} \times V_{\text{BAT}} \tag{7}$$

Gain of 10,  $R_g / R = 10$ , and Tol = 1%:

$$\text{Common mode error} = ((4 \times 0.01) / 1.1) \times 12 \text{ V} = 0.436 \text{ V}$$

Gain of 10 and Tol = 0.1%:

$$\text{Common mode error} = 43.6 \text{ mV}$$

The resistors were chosen from 2% batches.

$R_1$  and R 12 k $\Omega$

$R_2$  and  $R_g$  120 k $\Omega$

Ideal Gain = 120 / 12 = 10

The measured value of the resistors:

$R_1 = 11.835 \text{ k}\Omega$

R = 11.85 k $\Omega$

$R_2 = 117.92 \text{ k}\Omega$

$R_g = 118.07 \text{ k}\Omega$

### 8.2.1.3 Application Curves



## 9 Power Supply Recommendations

Supply voltage for a single supply is from 4.4 V to 16 V, and from  $\pm 2.2$  V to  $\pm 8$  V for dual supply. In the high-side sensing application, the supply is connected to a 12-V battery.

## 10 Layout

### 10.1 Layout Guidelines

The TLC227x and TLC227xA families of devices are wideband amplifiers. To realize the full operational performance of the devices, good high-frequency printed-circuit-board (PCB) layout practices are required. Low-loss 0.1- $\mu$ F bypass capacitors must be connected between each supply pin and ground as close to the device as possible. The bypass capacitor traces should be designed for minimum inductance.

### 10.2 Layout Example



Figure 63. Layout Example

## 11 Device and Documentation Support

### 11.1 Related Links

The table below lists quick access links. Categories include technical documents, support and community resources, tools and software, and quick access to sample or buy.

Table 4. Related Links

PARTS	PRODUCT FOLDER	SAMPLE & BUY	TECHNICAL DOCUMENTS	TOOLS & SOFTWARE	SUPPORT & COMMUNITY
TLC2272	<a href="#">Click here</a>	<a href="#">Click here</a>	<a href="#">Click here</a>	<a href="#">Click here</a>	<a href="#">Click here</a>
TLC2272A	<a href="#">Click here</a>	<a href="#">Click here</a>	<a href="#">Click here</a>	<a href="#">Click here</a>	<a href="#">Click here</a>
TLC2272M	<a href="#">Click here</a>	<a href="#">Click here</a>	<a href="#">Click here</a>	<a href="#">Click here</a>	<a href="#">Click here</a>
TLC2272AM	<a href="#">Click here</a>	<a href="#">Click here</a>	<a href="#">Click here</a>	<a href="#">Click here</a>	<a href="#">Click here</a>
TLC2274	<a href="#">Click here</a>	<a href="#">Click here</a>	<a href="#">Click here</a>	<a href="#">Click here</a>	<a href="#">Click here</a>
TLC2274A	<a href="#">Click here</a>	<a href="#">Click here</a>	<a href="#">Click here</a>	<a href="#">Click here</a>	<a href="#">Click here</a>
TLC2274M	<a href="#">Click here</a>	<a href="#">Click here</a>	<a href="#">Click here</a>	<a href="#">Click here</a>	<a href="#">Click here</a>
TLC2274AM	<a href="#">Click here</a>	<a href="#">Click here</a>	<a href="#">Click here</a>	<a href="#">Click here</a>	<a href="#">Click here</a>

### 11.2 Community Resources

The following links connect to TI community resources. Linked contents are provided "AS IS" by the respective contributors. They do not constitute TI specifications and do not necessarily reflect TI's views; see TI's [Terms of Use](#).

**TI E2E™ Online Community** *TI's Engineer-to-Engineer (E2E) Community*. Created to foster collaboration among engineers. At e2e.ti.com, you can ask questions, share knowledge, explore ideas and help solve problems with fellow engineers.

**Design Support** *TI's Design Support* Quickly find helpful E2E forums along with design support tools and contact information for technical support.

### 11.3 Trademarks

E2E is a trademark of Texas Instruments.  
 MicroSim Parts, PSpice are trademarks of MicroSim.  
 All other trademarks are the property of their respective owners.

### 11.4 Electrostatic Discharge Caution



These devices have limited built-in ESD protection. The leads should be shorted together or the device placed in conductive foam during storage or handling to prevent electrostatic damage to the MOS gates.

### 11.5 Glossary

[SLYZ022](#) — *TI Glossary*.

This glossary lists and explains terms, acronyms, and definitions.

## 12 Mechanical, Packaging, and Orderable Information

The following pages include mechanical, packaging, and orderable information. This information is the most current data available for the designated devices. This data is subject to change without notice and revision of this document. For browser-based versions of this data sheet, refer to the left-hand navigation.

**PACKAGING INFORMATION**

Orderable Device	Status (1)	Package Type	Package Drawing	Pins	Package Qty	Eco Plan (2)	Lead finish/ Ball material (6)	MSL Peak Temp (3)	Op Temp (°C)	Device Marking (4/5)	Samples
TLC2272ACD	ACTIVE	SOIC	D	8	75	RoHS & Green	NIPDAU	Level-1-260C-UNLIM		2272AC	<a href="#">Samples</a>
TLC2272ACDG4	ACTIVE	SOIC	D	8	75	TBD	Call TI	Call TI			<a href="#">Samples</a>
TLC2272ACDR	ACTIVE	SOIC	D	8	2500	RoHS & Green	NIPDAU	Level-1-260C-UNLIM		2272AC	<a href="#">Samples</a>
TLC2272ACDRG4	LIFEBUY	SOIC	D	8	2500	RoHS & Green	NIPDAU	Level-1-260C-UNLIM		2272AC	
TLC2272ACP	ACTIVE	PDIP	P	8	50	RoHS & Green	NIPDAU	N / A for Pkg Type		TLC2272AC	<a href="#">Samples</a>
TLC2272ACPWR	ACTIVE	TSSOP	PW	8	2000	RoHS & Green	NIPDAU	Level-1-260C-UNLIM		P2272A	<a href="#">Samples</a>
TLC2272AID	ACTIVE	SOIC	D	8	75	RoHS & Green	NIPDAU	Level-1-260C-UNLIM		2272AI	<a href="#">Samples</a>
TLC2272AIDG4	ACTIVE	SOIC	D	8	75	TBD	Call TI	Call TI			<a href="#">Samples</a>
TLC2272AIDR	ACTIVE	SOIC	D	8	2500	RoHS & Green	Call TI   NIPDAU	Level-1-260C-UNLIM		2272AI	<a href="#">Samples</a>
TLC2272AIDRG4	ACTIVE	SOIC	D	8	2500	TBD	Call TI	Call TI			<a href="#">Samples</a>
TLC2272AIP	ACTIVE	PDIP	P	8	50	RoHS & Green	NIPDAU	N / A for Pkg Type		TLC2272AI	<a href="#">Samples</a>
TLC2272AMD	ACTIVE	SOIC	D	8	75	RoHS & Green	NIPDAU	Level-1-260C-UNLIM	-55 to 125	2272AM	<a href="#">Samples</a>
TLC2272AMDG4	LIFEBUY	SOIC	D	8	75	RoHS & Green	NIPDAU	Level-1-260C-UNLIM		2272AM	
TLC2272AMDR	ACTIVE	SOIC	D	8	2500	RoHS & Green	NIPDAU	Level-1-260C-UNLIM	-55 to 125	2272AM	<a href="#">Samples</a>
TLC2272AMDRG4	ACTIVE	SOIC	D	8	2500	RoHS & Green	NIPDAU	Level-1-260C-UNLIM		2272AM	<a href="#">Samples</a>
TLC2272AQDR	ACTIVE	SOIC	D	8	2500	RoHS & Green	NIPDAU	Level-1-260C-UNLIM	-40 to 125	C2272A	<a href="#">Samples</a>
TLC2272AQDRG4	ACTIVE	SOIC	D	8	2500	RoHS & Green	NIPDAU	Level-1-260C-UNLIM		C2272A	<a href="#">Samples</a>
TLC2272CD	ACTIVE	SOIC	D	8	75	RoHS & Green	NIPDAU	Level-1-260C-UNLIM	0 to 70	2272C	<a href="#">Samples</a>
TLC2272CDR	ACTIVE	SOIC	D	8	2500	RoHS & Green	NIPDAU	Level-1-260C-UNLIM	0 to 70	2272C	<a href="#">Samples</a>
TLC2272CDRG4	LIFEBUY	SOIC	D	8	2500	RoHS & Green	NIPDAU	Level-1-260C-UNLIM	0 to 70	2272C	
TLC2272CP	ACTIVE	PDIP	P	8	50	RoHS & Green	NIPDAU	N / A for Pkg Type	0 to 70	TLC2272CP	<a href="#">Samples</a>

Orderable Device	Status (1)	Package Type	Package Drawing	Pins	Package Qty	Eco Plan (2)	Lead finish/ Ball material (6)	MSL Peak Temp (3)	Op Temp (°C)	Device Marking (4/5)	Samples
TLC2272CPSR	ACTIVE	SO	PS	8	2000	RoHS & Green	NIPDAU	Level-1-260C-UNLIM	0 to 70	P2272	<a href="#">Samples</a>
TLC2272CPW	ACTIVE	TSSOP	PW	8	150	RoHS & Green	NIPDAU	Level-1-260C-UNLIM	0 to 70	P2272	<a href="#">Samples</a>
TLC2272CPWR	ACTIVE	TSSOP	PW	8	2000	RoHS & Green	NIPDAU	Level-1-260C-UNLIM	0 to 70	P2272	<a href="#">Samples</a>
TLC2272ID	ACTIVE	SOIC	D	8	75	RoHS & Green	NIPDAU	Level-1-260C-UNLIM		2272I	<a href="#">Samples</a>
TLC2272IDR	ACTIVE	SOIC	D	8	2500	RoHS & Green	NIPDAU	Level-1-260C-UNLIM		2272I	<a href="#">Samples</a>
TLC2272IP	ACTIVE	PDIP	P	8	50	RoHS & Green	NIPDAU	N / A for Pkg Type		TLC2272IP	<a href="#">Samples</a>
TLC2272IPW	ACTIVE	TSSOP	PW	8	150	RoHS & Green	NIPDAU	Level-1-260C-UNLIM		Y2272	<a href="#">Samples</a>
TLC2272IPWR	ACTIVE	TSSOP	PW	8	2000	RoHS & Green	NIPDAU	Level-1-260C-UNLIM		Y2272	<a href="#">Samples</a>
TLC2272IPWRG4	ACTIVE	TSSOP	PW	8	2000	TBD	Call TI	Call TI			<a href="#">Samples</a>
TLC2272MDG4	LIFEBUY	SOIC	D	8	75	RoHS & Green	NIPDAU	Level-1-260C-UNLIM		2272M	
TLC2272MDR	ACTIVE	SOIC	D	8	2500	RoHS & Green	NIPDAU	Level-1-260C-UNLIM	-55 to 125	2272M	<a href="#">Samples</a>
TLC2272QPWRG4	ACTIVE	TSSOP	PW	8	2000	RoHS & Green	NIPDAU	Level-1-260C-UNLIM		T2272Q	<a href="#">Samples</a>
TLC2274ACD	ACTIVE	SOIC	D	14	50	RoHS & Green	NIPDAU	Level-1-260C-UNLIM	0 to 70	2274AC	<a href="#">Samples</a>
TLC2274ACDG4	ACTIVE	SOIC	D	14	50	TBD	Call TI	Call TI	0 to 70		<a href="#">Samples</a>
TLC2274ACDR	ACTIVE	SOIC	D	14	2500	RoHS & Green	NIPDAU	Level-1-260C-UNLIM	0 to 70	2274AC	<a href="#">Samples</a>
TLC2274ACDRG4	ACTIVE	SOIC	D	14	2500	TBD	Call TI	Call TI	0 to 70		<a href="#">Samples</a>
TLC2274ACN	ACTIVE	PDIP	N	14	25	RoHS & Green	NIPDAU	N / A for Pkg Type	0 to 70	TLC2274ACN	<a href="#">Samples</a>
TLC2274ACPWR	ACTIVE	TSSOP	PW	14	2000	RoHS & Green	NIPDAU	Level-1-260C-UNLIM	0 to 70	P2274A	<a href="#">Samples</a>
TLC2274ACPWRG4	ACTIVE	TSSOP	PW	14	2000	TBD	Call TI	Call TI	0 to 70		<a href="#">Samples</a>
TLC2274AID	ACTIVE	SOIC	D	14	50	RoHS & Green	NIPDAU	Level-1-260C-UNLIM	-40 to 125	2274AI	<a href="#">Samples</a>
TLC2274AIDR	ACTIVE	SOIC	D	14	2500	RoHS & Green	NIPDAU	Level-1-260C-UNLIM	-40 to 125	2274AI	<a href="#">Samples</a>

Orderable Device	Status (1)	Package Type	Package Drawing	Pins	Package Qty	Eco Plan (2)	Lead finish/ Ball material (6)	MSL Peak Temp (3)	Op Temp (°C)	Device Marking (4/5)	Samples
TLC2274AIN	ACTIVE	PDIP	N	14	25	RoHS & Green	NIPDAU	N / A for Pkg Type	-40 to 125	TLC2274AIN	<a href="#">Samples</a>
TLC2274AIPW	ACTIVE	TSSOP	PW	14	90	RoHS & Green	NIPDAU	Level-1-260C-UNLIM	-40 to 125	Y2274A	<a href="#">Samples</a>
TLC2274AIPWR	ACTIVE	TSSOP	PW	14	2000	RoHS & Green	NIPDAU	Level-1-260C-UNLIM	-40 to 125	Y2274A	<a href="#">Samples</a>
TLC2274AIPWRG4	ACTIVE	TSSOP	PW	14	2000	TBD	Call TI	Call TI	-40 to 125		<a href="#">Samples</a>
TLC2274AMD	ACTIVE	SOIC	D	14	50	RoHS & Green	NIPDAU	Level-1-260C-UNLIM	-55 to 125	2274AM	<a href="#">Samples</a>
TLC2274AMDG4	ACTIVE	SOIC	D	14	50	RoHS & Green	NIPDAU	Level-1-260C-UNLIM	-55 to 125	2274AM	<a href="#">Samples</a>
TLC2274AMDRG4	ACTIVE	SOIC	D	14	2500	RoHS & Green	NIPDAU	Level-1-260C-UNLIM	-55 to 125	2274AM	<a href="#">Samples</a>
TLC2274AQDR	ACTIVE	SOIC	D	14	2500	RoHS & Green	NIPDAU	Level-1-260C-UNLIM	-40 to 125	TLC2274A	<a href="#">Samples</a>
TLC2274AQDRG4	ACTIVE	SOIC	D	14	2500	RoHS & Green	NIPDAU	Level-1-260C-UNLIM		PJ2274A	<a href="#">Samples</a>
TLC2274CD	ACTIVE	SOIC	D	14	50	RoHS & Green	NIPDAU	Level-1-260C-UNLIM		TLC2274C	<a href="#">Samples</a>
TLC2274CDG4	ACTIVE	SOIC	D	14	50	TBD	Call TI	Call TI			<a href="#">Samples</a>
TLC2274CDR	ACTIVE	SOIC	D	14	2500	RoHS & Green	NIPDAU	Level-1-260C-UNLIM		TLC2274C	<a href="#">Samples</a>
TLC2274CN	ACTIVE	PDIP	N	14	25	RoHS & Green	NIPDAU	N / A for Pkg Type		TLC2274CN	<a href="#">Samples</a>
TLC2274CNE4	ACTIVE	PDIP	N	14	25	TBD	Call TI	Call TI			<a href="#">Samples</a>
TLC2274CNS	ACTIVE	SO	NS	14	50	RoHS & Green	NIPDAU	Level-1-260C-UNLIM		TLC2274	<a href="#">Samples</a>
TLC2274CNSR	ACTIVE	SO	NS	14	2000	RoHS & Green	NIPDAU	Level-1-260C-UNLIM		TLC2274	<a href="#">Samples</a>
TLC2274CPWR	ACTIVE	TSSOP	PW	14	2000	RoHS & Green	NIPDAU	Level-1-260C-UNLIM		P2274	<a href="#">Samples</a>
TLC2274ID	ACTIVE	SOIC	D	14	50	RoHS & Green	NIPDAU	Level-1-260C-UNLIM		TLC2274I	<a href="#">Samples</a>
TLC2274IDG4	ACTIVE	SOIC	D	14	50	TBD	Call TI	Call TI			<a href="#">Samples</a>
TLC2274IDR	ACTIVE	SOIC	D	14	2500	RoHS & Green	NIPDAU	Level-1-260C-UNLIM		TLC2274I	<a href="#">Samples</a>
TLC2274IN	ACTIVE	PDIP	N	14	25	RoHS & Green	NIPDAU	N / A for Pkg Type		TLC2274IN	<a href="#">Samples</a>

Orderable Device	Status (1)	Package Type	Package Drawing	Pins	Package Qty	Eco Plan (2)	Lead finish/ Ball material (6)	MSL Peak Temp (3)	Op Temp (°C)	Device Marking (4/5)	Samples
TLC2274IPW	ACTIVE	TSSOP	PW	14	90	RoHS & Green	NIPDAU	Level-1-260C-UNLIM		Y2274	<a href="#">Samples</a>
TLC2274IPWR	ACTIVE	TSSOP	PW	14	2000	RoHS & Green	NIPDAU	Level-1-260C-UNLIM		Y2274	<a href="#">Samples</a>
TLC2274IPWRG4	ACTIVE	TSSOP	PW	14	2000	TBD	Call TI	Call TI			<a href="#">Samples</a>
TLC2274MDG4	LIFEBUY	SOIC	D	14	50	RoHS & Green	NIPDAU	Level-1-260C-UNLIM		PJ2274M	
TLC2274MDR	ACTIVE	SOIC	D	14	2500	RoHS & Green	NIPDAU	Level-1-260C-UNLIM	-55 to 125	TLC2274M	<a href="#">Samples</a>
TLC2274MDRG4	LIFEBUY	SOIC	D	14	2500	RoHS & Green	NIPDAU	Level-1-260C-UNLIM		PJ2274M	
TLC2274MN	ACTIVE	PDIP	N	14	25	RoHS & Green	NIPDAU	N / A for Pkg Type	-55 to 125	TLC2274MN	<a href="#">Samples</a>

(1) The marketing status values are defined as follows:

**ACTIVE:** Product device recommended for new designs.

**LIFEBUY:** TI has announced that the device will be discontinued, and a lifetime-buy period is in effect.

**NRND:** Not recommended for new designs. Device is in production to support existing customers, but TI does not recommend using this part in a new design.

**PREVIEW:** Device has been announced but is not in production. Samples may or may not be available.

**OBSELETE:** TI has discontinued the production of the device.

(2) **RoHS:** TI defines "RoHS" to mean semiconductor products that are compliant with the current EU RoHS requirements for all 10 RoHS substances, including the requirement that RoHS substance do not exceed 0.1% by weight in homogeneous materials. Where designed to be soldered at high temperatures, "RoHS" products are suitable for use in specified lead-free processes. TI may reference these types of products as "Pb-Free".

**RoHS Exempt:** TI defines "RoHS Exempt" to mean products that contain lead but are compliant with EU RoHS pursuant to a specific EU RoHS exemption.

**Green:** TI defines "Green" to mean the content of Chlorine (Cl) and Bromine (Br) based flame retardants meet JS709B low halogen requirements of <=1000ppm threshold. Antimony trioxide based flame retardants must also meet the <=1000ppm threshold requirement.

(3) MSL, Peak Temp. - The Moisture Sensitivity Level rating according to the JEDEC industry standard classifications, and peak solder temperature.

(4) There may be additional marking, which relates to the logo, the lot trace code information, or the environmental category on the device.

(5) Multiple Device Markings will be inside parentheses. Only one Device Marking contained in parentheses and separated by a "~" will appear on a device. If a line is indented then it is a continuation of the previous line and the two combined represent the entire Device Marking for that device.

(6) Lead finish/Ball material - Orderable Devices may have multiple material finish options. Finish options are separated by a vertical ruled line. Lead finish/Ball material values may wrap to two lines if the finish value exceeds the maximum column width.

**Important Information and Disclaimer:**The information provided on this page represents TI's knowledge and belief as of the date that it is provided. TI bases its knowledge and belief on information provided by third parties, and makes no representation or warranty as to the accuracy of such information. Efforts are underway to better integrate information from third parties. TI has taken and continues to take reasonable steps to provide representative and accurate information but may not have conducted destructive testing or chemical analysis on incoming materials and chemicals. TI and TI suppliers consider certain information to be proprietary, and thus CAS numbers and other limited information may not be available for release.

In no event shall TI's liability arising out of such information exceed the total purchase price of the TI part(s) at issue in this document sold by TI to Customer on an annual basis.

**OTHER QUALIFIED VERSIONS OF TLC2272, TLC2272A, TLC2272AM, TLC2272M, TLC2274, TLC2274A, TLC2274AM, TLC2274M :**

- Catalog : [TLC2272A](#), [TLC2272](#), [TLC2274A](#), [TLC2274](#)
- Automotive : [TLC2272-Q1](#), [TLC2272A-Q1](#), [TLC2272A-Q1](#), [TLC2272-Q1](#), [TLC2274-Q1](#), [TLC2274A-Q1](#), [TLC2274A-Q1](#), [TLC2274-Q1](#)
- Enhanced Product : [TLC2272A-EP](#), [TLC2272A-EP](#), [TLC2274-EP](#), [TLC2274A-EP](#), [TLC2274A-EP](#), [TLC2274-EP](#)
- Military : [TLC2272M](#), [TLC2272AM](#), [TLC2274M](#), [TLC2274AM](#)

NOTE: Qualified Version Definitions:

- Catalog - TI's standard catalog product
- Automotive - Q100 devices qualified for high-reliability automotive applications targeting zero defects
- Enhanced Product - Supports Defense, Aerospace and Medical Applications
- Military - QML certified for Military and Defense Applications

## TAPE AND REEL INFORMATION



### QUADRANT ASSIGNMENTS FOR PIN 1 ORIENTATION IN TAPE

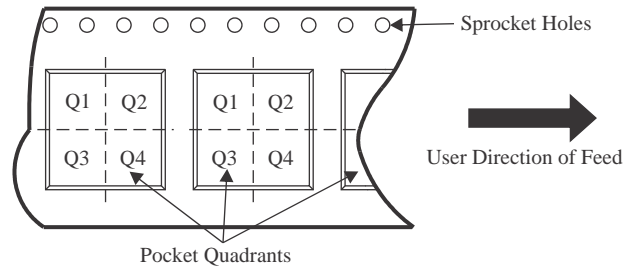

\*All dimensions are nominal

Device	Package Type	Package Drawing	Pins	SPQ	Reel Diameter (mm)	Reel Width W1 (mm)	A0 (mm)	B0 (mm)	K0 (mm)	P1 (mm)	W (mm)	Pin1 Quadrant
TLC2272ACDR	SOIC	D	8	2500	330.0	12.4	6.4	5.2	2.1	8.0	12.0	Q1
TLC2272ACPWR	TSSOP	PW	8	2000	330.0	12.4	7.0	3.6	1.6	8.0	12.0	Q1
TLC2272AIDR	SOIC	D	8	2500	330.0	12.4	6.4	5.2	2.1	8.0	12.0	Q1
TLC2272AMDR	SOIC	D	8	2500	330.0	12.4	6.4	5.2	2.1	8.0	12.0	Q1
TLC2272AMDRG4	SOIC	D	8	2500	330.0	12.4	6.4	5.2	2.1	8.0	12.0	Q1
TLC2272AQDR	SOIC	D	8	2500	330.0	12.5	6.4	5.2	2.1	8.0	12.0	Q1
TLC2272CDR	SOIC	D	8	2500	330.0	12.4	6.4	5.2	2.1	8.0	12.0	Q1
TLC2272CPSR	SO	PS	8	2000	330.0	16.4	8.35	6.6	2.5	12.0	16.0	Q1
TLC2272CPWR	TSSOP	PW	8	2000	330.0	12.4	7.0	3.6	1.6	8.0	12.0	Q1
TLC2272IDR	SOIC	D	8	2500	330.0	12.4	6.4	5.2	2.1	8.0	12.0	Q1
TLC2272IPWR	TSSOP	PW	8	2000	330.0	12.4	7.0	3.6	1.6	8.0	12.0	Q1
TLC2272MDR	SOIC	D	8	2500	330.0	12.4	6.4	5.2	2.1	8.0	12.0	Q1
TLC2272QPWRG4	TSSOP	PW	8	2000	330.0	12.4	7.0	3.6	1.6	8.0	12.0	Q1
TLC2274ACDR	SOIC	D	14	2500	330.0	16.4	6.5	9.0	2.1	8.0	16.0	Q1
TLC2274ACPWR	TSSOP	PW	14	2000	330.0	12.4	6.9	5.6	1.6	8.0	12.0	Q1
TLC2274AIDR	SOIC	D	14	2500	330.0	16.4	6.5	9.0	2.1	8.0	16.0	Q1

Device	Package Type	Package Drawing	Pins	SPQ	Reel Diameter (mm)	Reel Width W1 (mm)	A0 (mm)	B0 (mm)	K0 (mm)	P1 (mm)	W (mm)	Pin1 Quadrant
TLC2274AIPWR	TSSOP	PW	14	2000	330.0	12.4	6.9	5.6	1.6	8.0	12.0	Q1
TLC2274AQDR	SOIC	D	14	2500	330.0	16.4	6.5	9.0	2.1	8.0	16.0	Q1
TLC2274CDR	SOIC	D	14	2500	330.0	16.4	6.5	9.0	2.1	8.0	16.0	Q1
TLC2274CNSR	SO	NS	14	2000	330.0	16.4	8.2	10.5	2.5	12.0	16.0	Q1
TLC2274CPWR	TSSOP	PW	14	2000	330.0	12.4	6.9	5.6	1.6	8.0	12.0	Q1
TLC2274IDR	SOIC	D	14	2500	330.0	16.4	6.5	9.0	2.1	8.0	16.0	Q1
TLC2274IPWR	TSSOP	PW	14	2000	330.0	12.4	6.9	5.6	1.6	8.0	12.0	Q1
TLC2274MDR	SOIC	D	14	2500	330.0	16.4	6.5	9.0	2.1	8.0	16.0	Q1
TLC2274MDRG4	SOIC	D	14	2500	330.0	16.4	6.5	9.0	2.1	8.0	16.0	Q1

**TAPE AND REEL BOX DIMENSIONS**

\*All dimensions are nominal

Device	Package Type	Package Drawing	Pins	SPQ	Length (mm)	Width (mm)	Height (mm)
TLC2272ACDR	SOIC	D	8	2500	340.5	338.1	20.6
TLC2272ACPWR	TSSOP	PW	8	2000	356.0	356.0	35.0
TLC2272AIDR	SOIC	D	8	2500	340.5	338.1	20.6
TLC2272AMDR	SOIC	D	8	2500	350.0	350.0	43.0
TLC2272AMDRG4	SOIC	D	8	2500	350.0	350.0	43.0
TLC2272AQDR	SOIC	D	8	2500	340.5	338.1	20.6
TLC2272CDR	SOIC	D	8	2500	340.5	338.1	20.6
TLC2272CPSR	SO	PS	8	2000	367.0	367.0	38.0
TLC2272CPWR	TSSOP	PW	8	2000	356.0	356.0	35.0
TLC2272IDR	SOIC	D	8	2500	340.5	338.1	20.6
TLC2272IPWR	TSSOP	PW	8	2000	356.0	356.0	35.0
TLC2272MDR	SOIC	D	8	2500	350.0	350.0	43.0
TLC2272QPWRG4	TSSOP	PW	8	2000	356.0	356.0	35.0
TLC2274ACDR	SOIC	D	14	2500	340.5	336.1	32.0
TLC2274ACPWR	TSSOP	PW	14	2000	356.0	356.0	35.0
TLC2274AIDR	SOIC	D	14	2500	333.2	345.9	28.6
TLC2274AIPWR	TSSOP	PW	14	2000	356.0	356.0	35.0
TLC2274AQDR	SOIC	D	14	2500	350.0	350.0	43.0

---

Device	Package Type	Package Drawing	Pins	SPQ	Length (mm)	Width (mm)	Height (mm)
TLC2274CDR	SOIC	D	14	2500	333.2	345.9	28.6
TLC2274CNSR	SO	NS	14	2000	356.0	356.0	35.0
TLC2274CPWR	TSSOP	PW	14	2000	356.0	356.0	35.0
TLC2274IDR	SOIC	D	14	2500	333.2	345.9	28.6
TLC2274IPWR	TSSOP	PW	14	2000	356.0	356.0	35.0
TLC2274MDR	SOIC	D	14	2500	350.0	350.0	43.0
TLC2274MDRG4	SOIC	D	14	2500	350.0	350.0	43.0

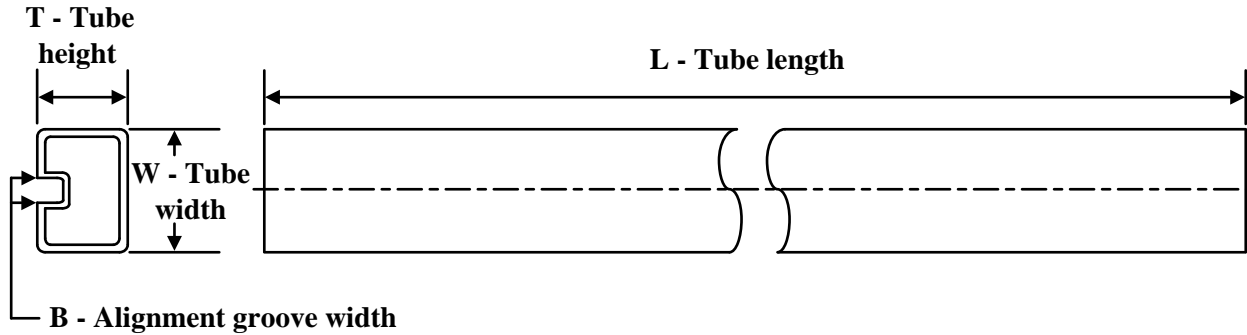
**TUBE**

\*All dimensions are nominal

Device	Package Name	Package Type	Pins	SPQ	L (mm)	W (mm)	T (µm)	B (mm)
TLC2272ACD	D	SOIC	8	75	505.46	6.76	3810	4
TLC2272ACD	D	SOIC	8	75	507	8	3940	4.32
TLC2272ACP	P	PDIP	8	50	506	13.97	11230	4.32
TLC2272AID	D	SOIC	8	75	507	8	3940	4.32
TLC2272AID	D	SOIC	8	75	505.46	6.76	3810	4
TLC2272AIP	P	PDIP	8	50	506	13.97	11230	4.32
TLC2272AMD	D	SOIC	8	75	505.46	6.76	3810	4
TLC2272AMDG4	D	SOIC	8	75	505.46	6.76	3810	4
TLC2272CD	D	SOIC	8	75	507	8	3940	4.32
TLC2272CD	D	SOIC	8	75	505.46	6.76	3810	4
TLC2272CP	P	PDIP	8	50	506	13.97	11230	4.32
TLC2272CPW	PW	TSSOP	8	150	530	10.2	3600	3.5
TLC2272ID	D	SOIC	8	75	507	8	3940	4.32
TLC2272IP	P	PDIP	8	50	506	13.97	11230	4.32
TLC2272IPW	PW	TSSOP	8	150	530	10.2	3600	3.5
TLC2272MDG4	D	SOIC	8	75	505.46	6.76	3810	4
TLC2274ACD	D	SOIC	14	50	507	8	3940	4.32
TLC2274ACD	D	SOIC	14	50	505.46	6.76	3810	4
TLC2274ACN	N	PDIP	14	25	506	13.97	11230	4.32
TLC2274AID	D	SOIC	14	50	507	8	3940	4.32
TLC2274AIN	N	PDIP	14	25	506	13.97	11230	4.32
TLC2274AIPW	PW	TSSOP	14	90	530	10.2	3600	3.5
TLC2274AMD	D	SOIC	14	50	505.46	6.76	3810	4
TLC2274AMDG4	D	SOIC	14	50	505.46	6.76	3810	4
TLC2274CD	D	SOIC	14	50	507	8	3940	4.32
TLC2274CD	D	SOIC	14	50	505.46	6.76	3810	4
TLC2274CN	N	PDIP	14	25	506	13.97	11230	4.32
TLC2274CNS	NS	SOP	14	50	530	10.5	4000	4.1
TLC2274ID	D	SOIC	14	50	507	8	3940	4.32

---

Device	Package Name	Package Type	Pins	SPQ	L (mm)	W (mm)	T (μm)	B (mm)
TLC2274ID	D	SOIC	14	50	505.46	6.76	3810	4
TLC2274IN	N	PDIP	14	25	506	13.97	11230	4.32
TLC2274IPW	PW	TSSOP	14	90	530	10.2	3600	3.5
TLC2274MDG4	D	SOIC	14	50	505.46	6.76	3810	4
TLC2274MN	N	PDIP	14	25	506	13.97	11230	4.32

# MECHANICAL DATA

NS (R-PDSO-G\*\*)

PLASTIC SMALL-OUTLINE PACKAGE

14-PINS SHOWN



- NOTES:
- A. All linear dimensions are in millimeters.
  - B. This drawing is subject to change without notice.
  - C. Body dimensions do not include mold flash or protrusion, not to exceed 0,15.

D (R-PDSO-G14)

PLASTIC SMALL OUTLINE

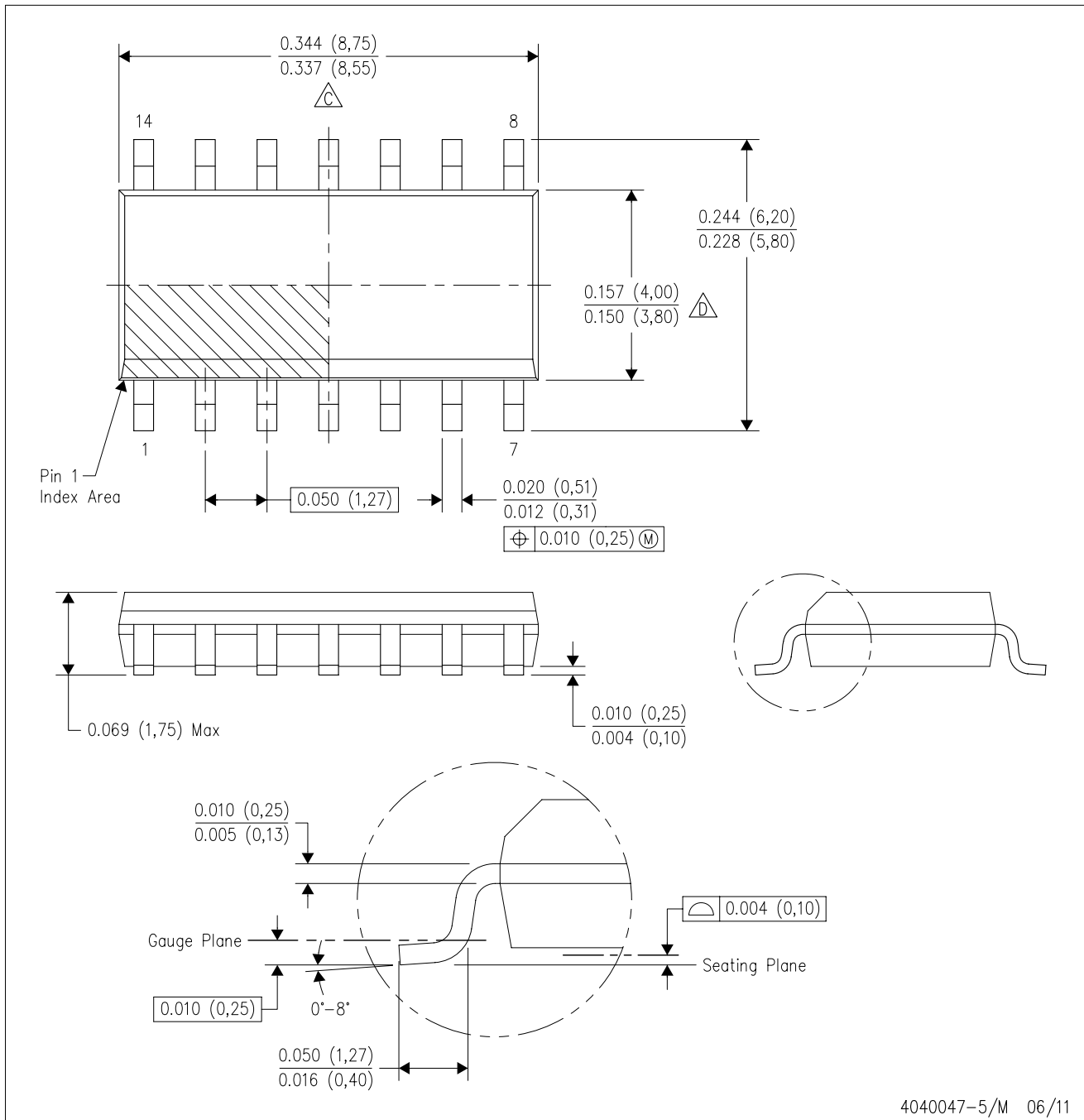

- NOTES:
- A. All linear dimensions are in inches (millimeters).
  - B. This drawing is subject to change without notice.
  - Body length does not include mold flash, protrusions, or gate burrs. Mold flash, protrusions, or gate burrs shall not exceed 0.006 (0,15) each side.
  - Body width does not include interlead flash. Interlead flash shall not exceed 0.017 (0,43) each side.
  - E. Reference JEDEC MS-012 variation AB.

D (R-PDSO-G14)

PLASTIC SMALL OUTLINE

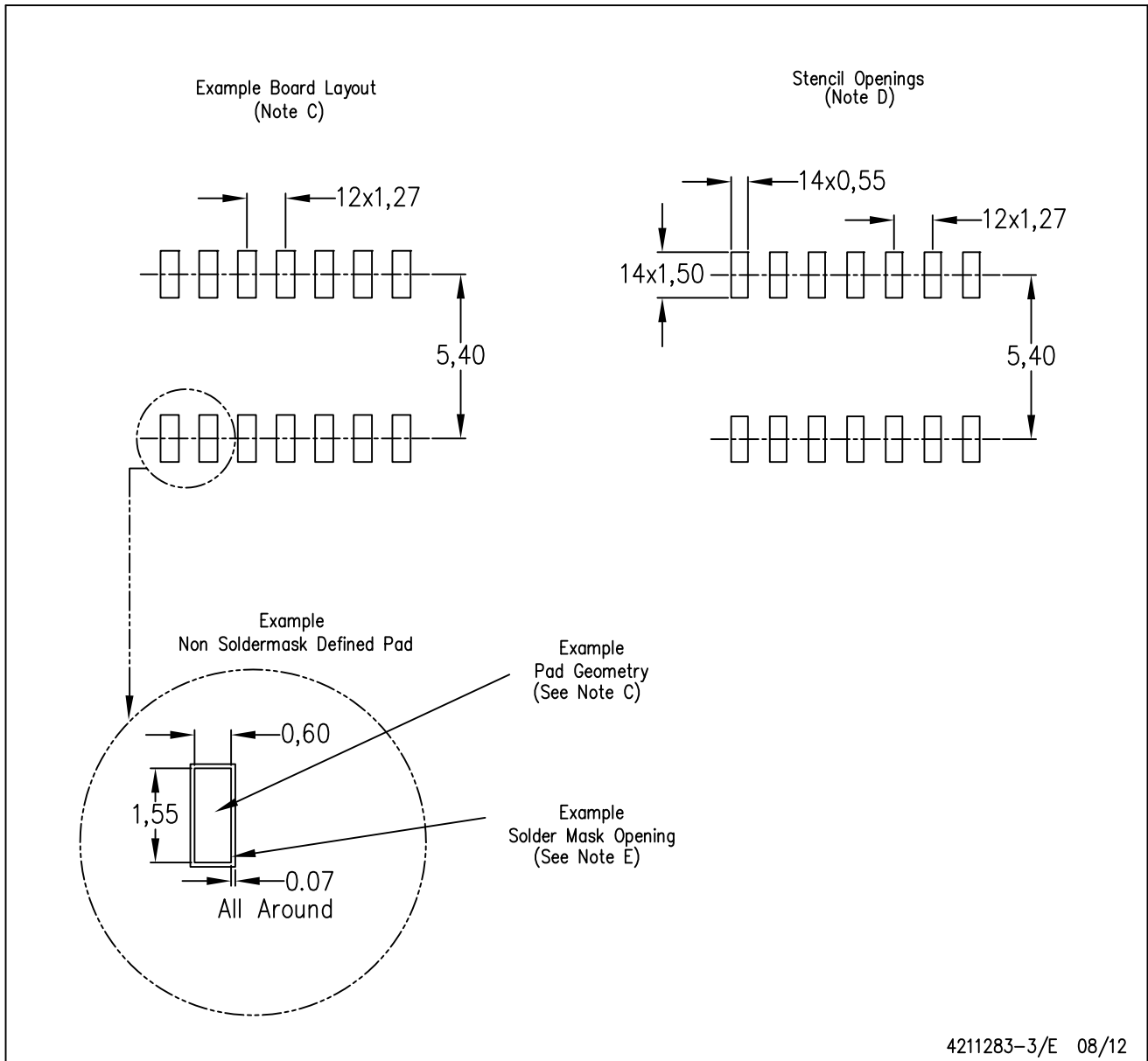

4211283-3/E 08/12

- NOTES:
- All linear dimensions are in millimeters.
  - This drawing is subject to change without notice.
  - Publication IPC-7351 is recommended for alternate designs.
  - Laser cutting apertures with trapezoidal walls and also rounding corners will offer better paste release. Customers should contact their board assembly site for stencil design recommendations. Refer to IPC-7525 for other stencil recommendations.
  - Customers should contact their board fabrication site for solder mask tolerances between and around signal pads.

PW (R-PDSO-G14)

PLASTIC SMALL OUTLINE

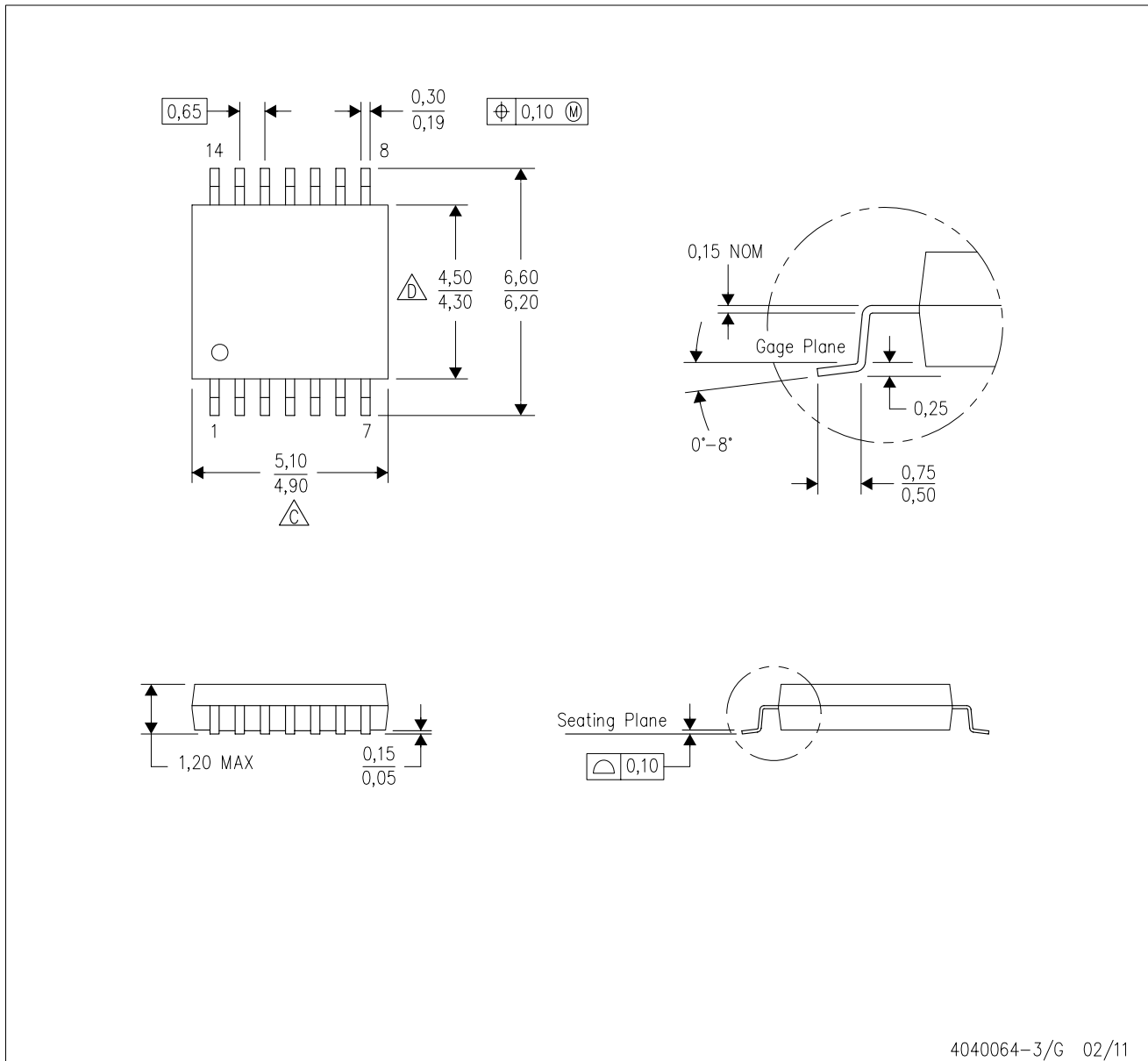

4040064-3/G 02/11

- NOTES:
- A. All linear dimensions are in millimeters. Dimensioning and tolerancing per ASME Y14.5M-1994.
  - B. This drawing is subject to change without notice.
  - C. Body length does not include mold flash, protrusions, or gate burrs. Mold flash, protrusions, or gate burrs shall not exceed 0,15 each side.
  - D. Body width does not include interlead flash. Interlead flash shall not exceed 0,25 each side.
  - E. Falls within JEDEC MO-153



D0008A

# PACKAGE OUTLINE

SOIC - 1.75 mm max height

SMALL OUTLINE INTEGRATED CIRCUIT



4214825/C 02/2019

### NOTES:

1. Linear dimensions are in inches [millimeters]. Dimensions in parenthesis are for reference only. Controlling dimensions are in inches. Dimensioning and tolerancing per ASME Y14.5M.
2. This drawing is subject to change without notice.
3. This dimension does not include mold flash, protrusions, or gate burrs. Mold flash, protrusions, or gate burrs shall not exceed .006 [0.15] per side.
4. This dimension does not include interlead flash.
5. Reference JEDEC registration MS-012, variation AA.

# EXAMPLE BOARD LAYOUT

D0008A

SOIC - 1.75 mm max height

SMALL OUTLINE INTEGRATED CIRCUIT



LAND PATTERN EXAMPLE  
 EXPOSED METAL SHOWN  
 SCALE:8X



SOLDER MASK DETAILS

4214825/C 02/2019

NOTES: (continued)

- 6. Publication IPC-7351 may have alternate designs.
- 7. Solder mask tolerances between and around signal pads can vary based on board fabrication site.

# EXAMPLE STENCIL DESIGN

D0008A

SOIC - 1.75 mm max height

SMALL OUTLINE INTEGRATED CIRCUIT



SOLDER PASTE EXAMPLE  
BASED ON .005 INCH [0.125 MM] THICK STENCIL  
SCALE:8X

4214825/C 02/2019

NOTES: (continued)

8. Laser cutting apertures with trapezoidal walls and rounded corners may offer better paste release. IPC-7525 may have alternate design recommendations.
9. Board assembly site may have different recommendations for stencil design.

## MECHANICAL DATA

PS (R-PDSO-G8)

PLASTIC SMALL-OUTLINE PACKAGE

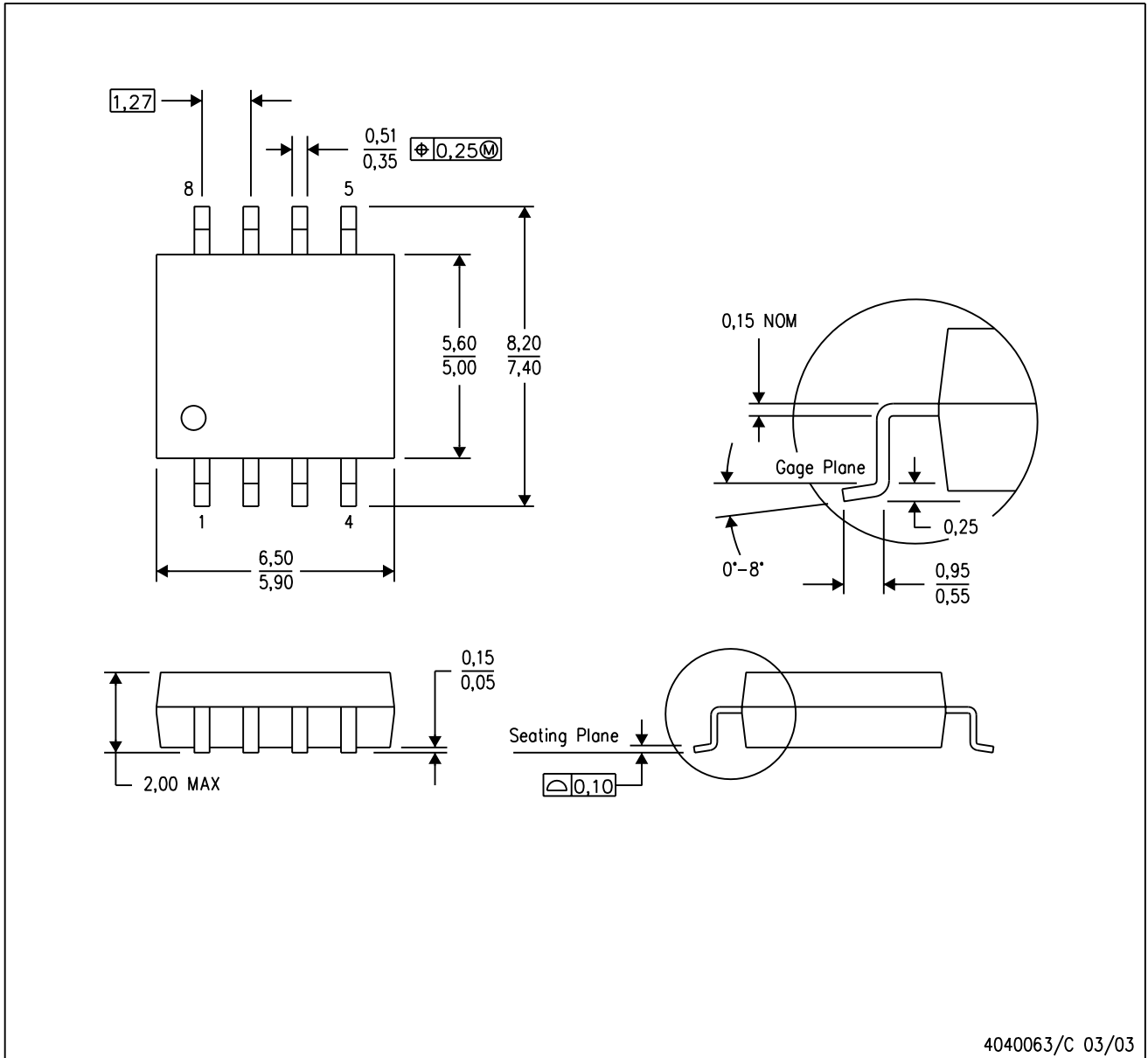

- NOTES:
- A. All linear dimensions are in millimeters.
  - B. This drawing is subject to change without notice.
  - C. Body dimensions do not include mold flash or protrusion, not to exceed 0,15.

PS (R-PDSO-G8)

PLASTIC SMALL OUTLINE

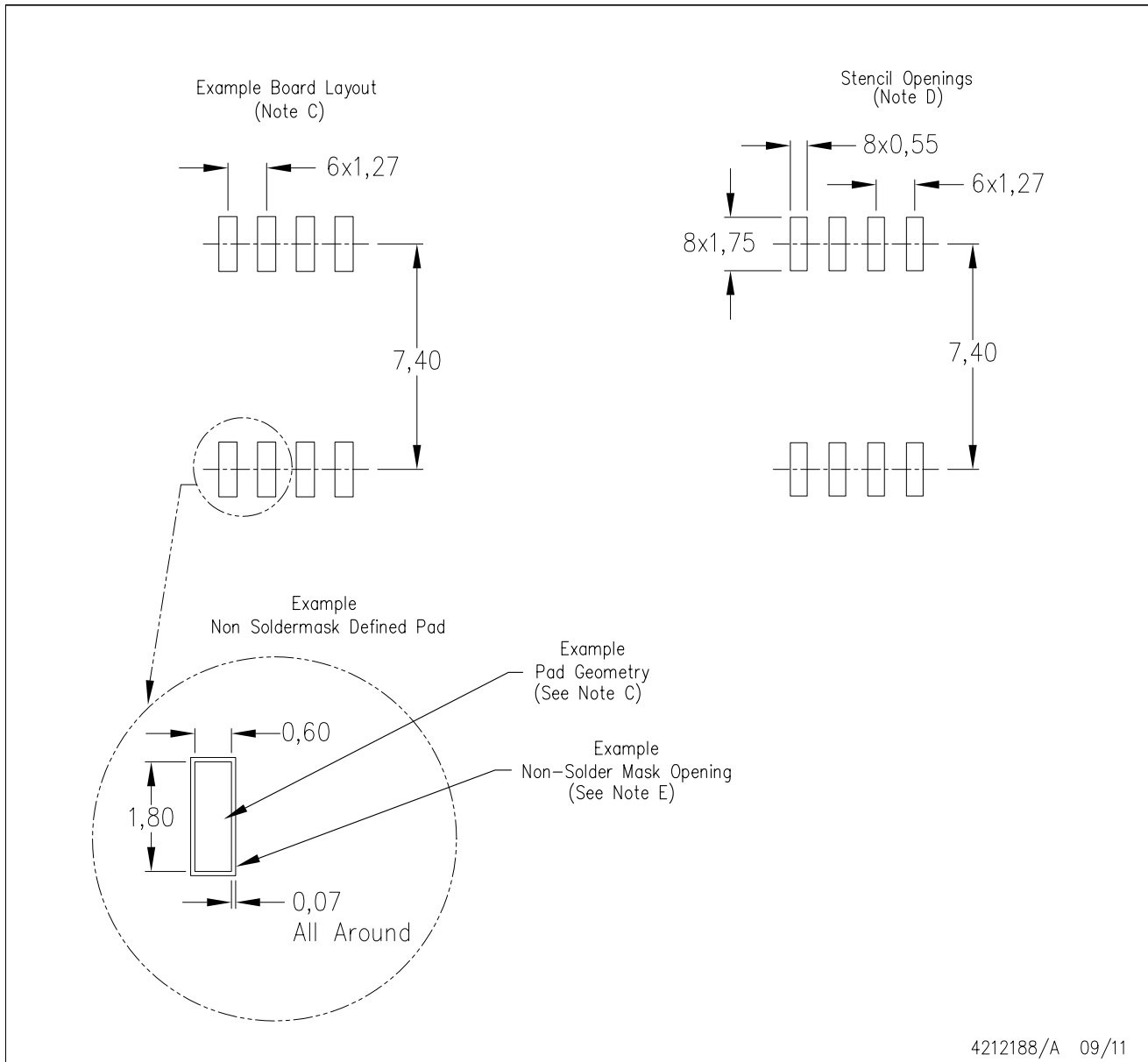

- NOTES:
- A. All linear dimensions are in millimeters.
  - B. This drawing is subject to change without notice.
  - C. Publication IPC-7351 is recommended for alternate designs.
  - D. Laser cutting apertures with trapezoidal walls and also rounding corners will offer better paste release. Customers should contact their board assembly site for stencil design recommendations. Refer to IPC-7525 for other stencil recommendations.
  - E. Customers should contact their board fabrication site for solder mask tolerances between and around signal pads.

P (R-PDIP-T8)

PLASTIC DUAL-IN-LINE PACKAGE

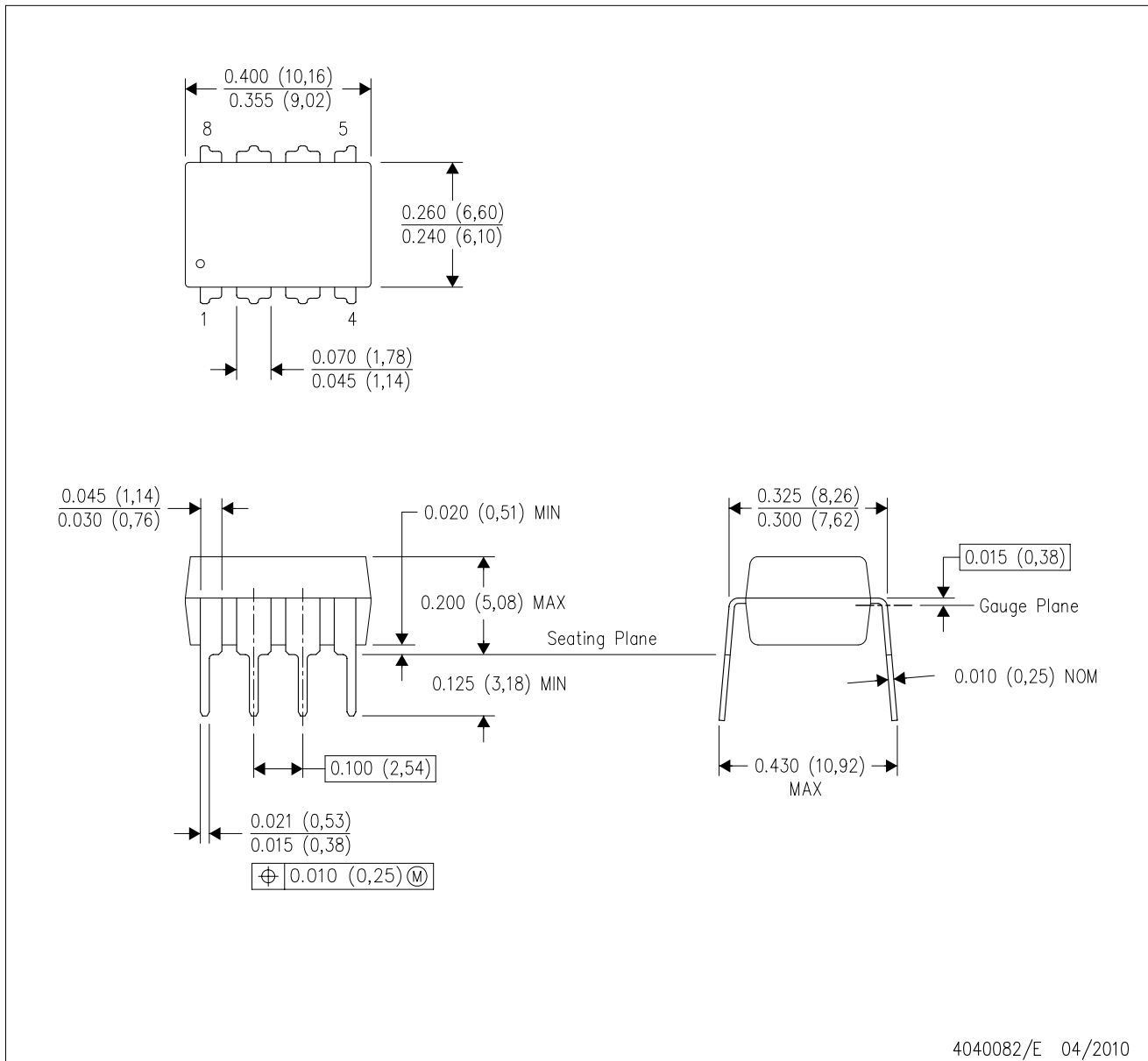

- NOTES:
- A. All linear dimensions are in inches (millimeters).
  - B. This drawing is subject to change without notice.
  - C. Falls within JEDEC MS-001 variation BA.

N (R-PDIP-T\*\*)

PLASTIC DUAL-IN-LINE PACKAGE

16 PINS SHOWN

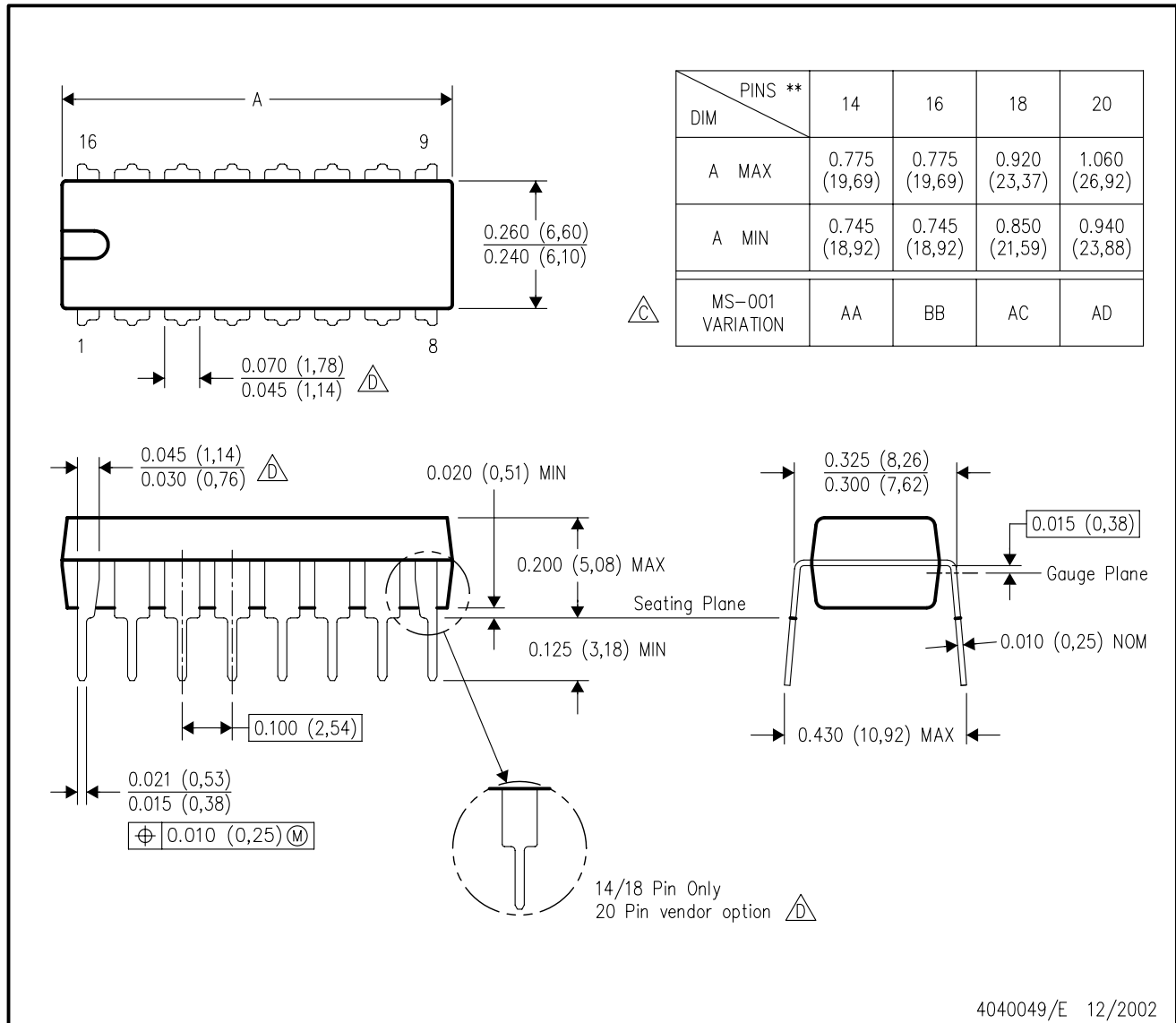

- NOTES:
- A. All linear dimensions are in inches (millimeters).
  - B. This drawing is subject to change without notice.
  - Falls within JEDEC MS-001, except 18 and 20 pin minimum body length (Dim A).
  - The 20 pin end lead shoulder width is a vendor option, either half or full width.

PW0008A



PACKAGE OUTLINE  
TSSOP - 1.2 mm max height

SMALL OUTLINE PACKAGE



4221848/A 02/2015

NOTES:

1. All linear dimensions are in millimeters. Any dimensions in parenthesis are for reference only. Dimensioning and tolerancing per ASME Y14.5M.
2. This drawing is subject to change without notice.
3. This dimension does not include mold flash, protrusions, or gate burrs. Mold flash, protrusions, or gate burrs shall not exceed 0.15 mm per side.
4. This dimension does not include interlead flash. Interlead flash shall not exceed 0.25 mm per side.
5. Reference JEDEC registration MO-153, variation AA.

# EXAMPLE BOARD LAYOUT

PW0008A

TSSOP - 1.2 mm max height

SMALL OUTLINE PACKAGE



LAND PATTERN EXAMPLE  
SCALE:10X



SOLDER MASK DETAILS  
NOT TO SCALE

4221848/A 02/2015

NOTES: (continued)

- 6. Publication IPC-7351 may have alternate designs.
- 7. Solder mask tolerances between and around signal pads can vary based on board fabrication site.

# EXAMPLE STENCIL DESIGN

PW0008A

TSSOP - 1.2 mm max height

SMALL OUTLINE PACKAGE



SOLDER PASTE EXAMPLE  
BASED ON 0.125 mm THICK STENCIL  
SCALE:10X

4221848/A 02/2015

NOTES: (continued)

8. Laser cutting apertures with trapezoidal walls and rounded corners may offer better paste release. IPC-7525 may have alternate design recommendations.
9. Board assembly site may have different recommendations for stencil design.

## IMPORTANT NOTICE AND DISCLAIMER

TI PROVIDES TECHNICAL AND RELIABILITY DATA (INCLUDING DATA SHEETS), DESIGN RESOURCES (INCLUDING REFERENCE DESIGNS), APPLICATION OR OTHER DESIGN ADVICE, WEB TOOLS, SAFETY INFORMATION, AND OTHER RESOURCES "AS IS" AND WITH ALL FAULTS, AND DISCLAIMS ALL WARRANTIES, EXPRESS AND IMPLIED, INCLUDING WITHOUT LIMITATION ANY IMPLIED WARRANTIES OF MERCHANTABILITY, FITNESS FOR A PARTICULAR PURPOSE OR NON-INFRINGEMENT OF THIRD PARTY INTELLECTUAL PROPERTY RIGHTS.

These resources are intended for skilled developers designing with TI products. You are solely responsible for (1) selecting the appropriate TI products for your application, (2) designing, validating and testing your application, and (3) ensuring your application meets applicable standards, and any other safety, security, regulatory or other requirements.

These resources are subject to change without notice. TI grants you permission to use these resources only for development of an application that uses the TI products described in the resource. Other reproduction and display of these resources is prohibited. No license is granted to any other TI intellectual property right or to any third party intellectual property right. TI disclaims responsibility for, and you will fully indemnify TI and its representatives against, any claims, damages, costs, losses, and liabilities arising out of your use of these resources.

TI's products are provided subject to [TI's Terms of Sale](#) or other applicable terms available either on [ti.com](https://www.ti.com) or provided in conjunction with such TI products. TI's provision of these resources does not expand or otherwise alter TI's applicable warranties or warranty disclaimers for TI products.

TI objects to and rejects any additional or different terms you may have proposed.

Mailing Address: Texas Instruments, Post Office Box 655303, Dallas, Texas 75265  
Copyright © 2024, Texas Instruments Incorporated

## Looking for pricing, stock, or lifecycle information?

Click below to explore more details on WIN SOURCE:

 [View TLC2272CPS](#) on WIN SOURCE

 [Texas Instruments](#) Information

## Optimize Your Supply Chain with WIN SOURCE Solutions

-  Global Sourcing Solution
-  Obsolete Management
-  Cost Control Management
-  Shortage Management
-  Alternative Solution
-  Excess Inventory Management