



**THE DATASHEET OF
TL6120DF130QG**



TL6120 SERIES TACT SWITCH

ANTI-VANDAL SWITCHES
 DETECTOR SWITCHES
 DIP SWITCHES
 KEYLOCK SWITCHES
 NAVIGATION SWITCHES
 PUSHBUTTON SWITCHES
 ROCKER SWITCHES
 ROTARY SWITCHES
 SLIDE SWITCHES
 SNAP ACTION SWITCHES
TACTILE SWITCHES
 TOGGLE SWITCHES
 CAP OPTIONS



APPLICATIONS / MARKETS

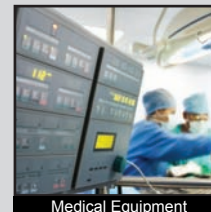
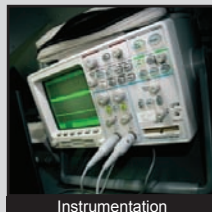
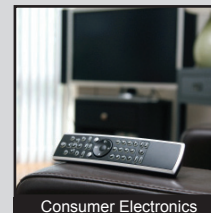
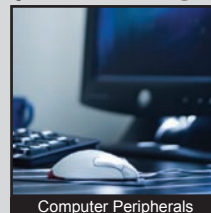
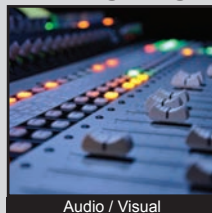

RoHS

SPECIFICATIONS

Electrical Rating: 50mA @ 12VDC
Life Expectancy: per chart
Contact Resistance: 100mΩ Max. Initial
Insulation Resistance: 100 MΩ Min. at 100VAC
Dielectric Strength: 250VAC for 1 min.
Operating Temperature: -40°C to 85°C
Storage Temperature: -40°C to 85°C
Operating Force: 130 gf, 160 gf, 300 gf, 500 gf
Travel: 0.50mm
Contact Arrangement: SPST

FEATURES & BENEFITS

- Tape & Reel packaging
- Multiple operating forces
- Gold or silver contact option
- Multiple actuator lengths
- Process sealed

PART NUMBER CONFIGURATOR

Series	Actuator Options	Actuation Force	Contact Plating	Termination										
<input type="checkbox"/> <input type="checkbox"/> <input type="checkbox"/> <input type="checkbox"/> <input type="checkbox"/> <input type="checkbox"/> TL6120 - surface mount	<input type="checkbox"/> A - 4.70mm B - 5.20mm C - 6.90mm D - 10.0mm	<input type="checkbox"/> <input type="checkbox"/> <input type="checkbox"/> <input type="checkbox"/> F130 - 130 gf F160 - 160 gf F300 - 300 gf F500 - 500 gf	<input type="checkbox"/> Q - Silver R - Gold	<input type="checkbox"/> G - Gullwing										
		<table border="1"> <thead> <tr> <th>Actuation Force</th> <th>Life Cycles</th> </tr> </thead> <tbody> <tr> <td>130 gf</td> <td>1,000,000</td> </tr> <tr> <td>160 gf</td> <td>1,000,000</td> </tr> <tr> <td>300 gf</td> <td>500,000</td> </tr> <tr> <td>500 gf</td> <td>200,000</td> </tr> </tbody> </table>	Actuation Force	Life Cycles	130 gf	1,000,000	160 gf	1,000,000	300 gf	500,000	500 gf	200,000		
Actuation Force	Life Cycles													
130 gf	1,000,000													
160 gf	1,000,000													
300 gf	500,000													
500 gf	200,000													

Specifications subject to change without notice



E-SWITCH®

www.e-switch.com

800.867.2717

2

TL6120 SERIES TACT SWITCH

BODY DIMENSIONS

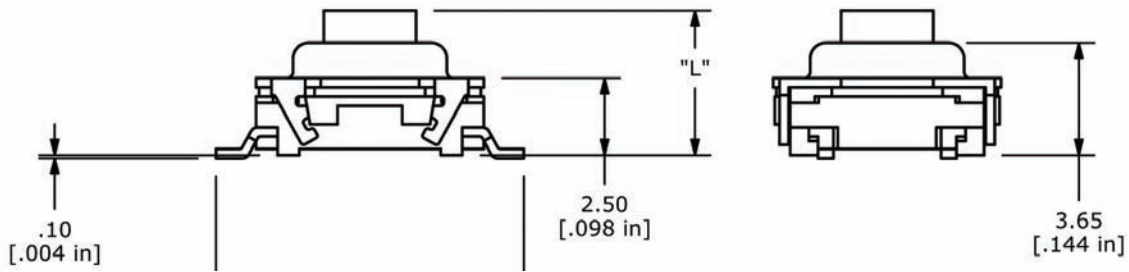
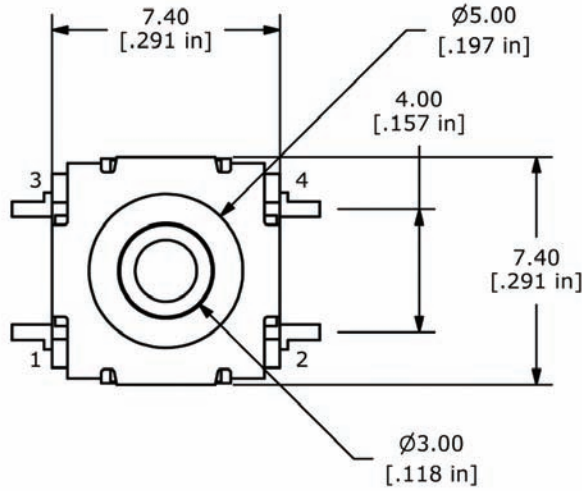

Actuator	"L" Dimension
A	4.70
B	5.20
C	6.90
D	10.00

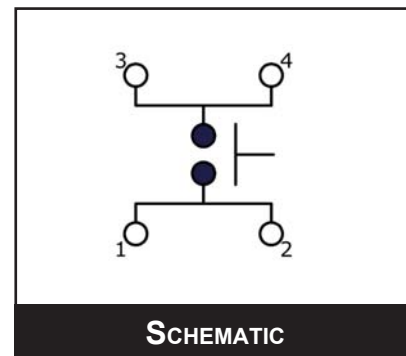
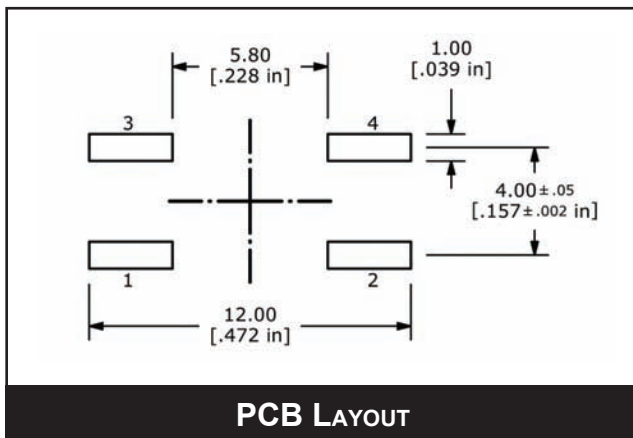

ANTI-VANDAL SWITCHES
 DETECTOR SWITCHES
 DIP SWITCHES
 KEYLOCK SWITCHES
 NAVIGATION SWITCHES
 PUSHBUTTON SWITCHES
 ROCKER SWITCHES
 ROTARY SWITCHES
 SLIDE SWITCHES
 SNAP ACTION SWITCHES
TACTILE SWITCHES
 TOGGLE SWITCHES
 CAP OPTIONS



Looking for pricing, stock, or lifecycle information?

Click below to explore more details on WIN SOURCE:

 [View TL6120DF130QG on WIN SOURCE](#)

 [E-Switch Information](#)

Optimize Your Supply Chain with WIN SOURCE Solutions

-  Global Sourcing Solution
-  Obsolete Management
-  Cost Control Management
-  Shortage Management
-  Alternative Solution
-  Excess Inventory Management