



**THE DATASHEET OF
TISP4360H3BJR**





BIDIRECTIONAL THYRISTOR OVERVOLTAGE PROTECTORS

TISP4360H3BJ Overvoltage Protector Series

Matched to FCC Part 68 POTS + ADSL Voltages

- Working Voltage, V_{DRM} 290 V
- Protection Voltage, $V_{(BO)}$ 360 V

High FCC, Bellcore & ITU-T Surge Ratings

Waveshape	Standard	I_{TSP} A
2/10 μ s	GR-1089-CORE	500
8/20 μ s	IEC 61000-4-5	300
10/160 μ s	FCC Part 68	250
10/700 μ s	ITU-T K.20/21 FCC Part 68	200
10/560 μ s	FCC Part 68	160
10/1000 μ s	GR-1089-CORE	100

High UL 1950, Bellcore & ITU-T AC Capability

Standard	Applied AC A r.m.s.	'4360 $I_{T(OVM)}$ Limits
UL 1950 (ANNEX NAC)	40	0.04
	7	4.2
	2.2	SURVIVES
GR-1089-CORE	60	0.015
	30	0.08
	15	0.48
	2.2	SURVIVES
ITU-T K.20/21	23	0.15
	1	SURVIVES

SMBJ Package (Top View)

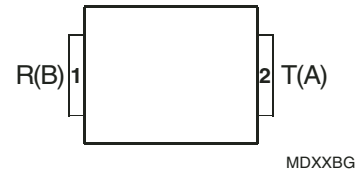

Device Symbol



Terminals T and R correspond to the alternative line designators of A and B

Large creepage distance 2.54 mm (0.1 in.)

Low Capacitance 24 pF @ 50 V
70 pF @ 0

..... UL Recognized Component

Description

The TISP4360H3BJ is designed to limit overvoltages on equipment used for telephone lines carrying POTS (Plain Old Telephone System) and ADSL (Asymmetrical Digital Subscriber Line) signals. TISP4360H3BJ a.c. overload limits are specified for designers to select the correct overcurrent protectors to meet safety requirements, e.g. UL 1950.

The protector consists of a symmetrical voltage-triggered bidirectional thyristor. Overvoltages are initially clipped by breakdown clamping. If sufficient current is available from the overvoltage, the breakdown voltage will rise to the breakover level, which causes the device to switch into a low-voltage on-state condition. This switching action removes the high voltage stress from the following circuitry and causes the current resulting from the overvoltage to be safely diverted through the protector. The high holding (switch off) current prevents d.c. latchup as the diverted current subsides.

The TISP4360H3BJ is guaranteed to voltage limit and withstand the listed international lightning surges in both polarities. This high (H) current protection device is in a plastic SMBJ package (JEDEC DO-214AA with J-bend leads) and supplied in embossed carrier reel pack. For alternative voltage and holding current values, consult the factory.

How To Order

Device	Package	Carrier	Order As
TISP4360H3BJ	BJ (J-Bend DO-214AA/SMB)	Embossed Tape Reeled	TISP4360H3BJR-S

TISP4360H3BJ Overvoltage Protector Series

BOURNS®

Absolute Maximum Ratings, $T_A = 25\text{ }^\circ\text{C}$ (Unless Otherwise Noted)

Rating	Symbol	Value	Unit
Repetitive peak off-state voltage, (see Note 1)	V_{DRM}	± 290	V
Non-repetitive peak on-state pulse current (see Notes 2, 3 and 4)	I_{TSP}	2/10 μs (GR-1089-CORE, 2/10 μs voltage wave shape)	500
8/20 μs (IEC 61000-4-5, 1.2/50 μs voltage, 8/20 current combination wave generator)		300	
10/160 μs (FCC Part 68, 10/160 μs voltage wave shape)		250	
5/200 μs (VDE 0433, 10/700 μs voltage wave shape)		220	
0.2/310 μs (I3124, 0.5/700 μs voltage wave shape)		200	
5/310 μs (ITU-T K.20/21, 10/700 μs voltage wave shape)		200	
5/310 μs (FTZ R12, 10/700 μs voltage wave shape)		200	
10/560 μs (FCC Part 68, 10/560 μs voltage wave shape)		160	
10/1000 μs (GR-1089-CORE, 10/1000 μs voltage wave shape)		100	
Non-repetitive peak on-state current (see Notes 2, 3 and 5)	I_{TSM}	20 ms (50 Hz) full sine wave	55
16.7 ms (60 Hz) full sine wave		60	
1000 s 50 Hz/60 Hz a.c.		2.2	
Maximum overload on-state current without open circuit, 50 Hz/60 Hz a.c.	$I_{\text{T(OV)M}}$	0.015 s	60
0.04 s		40	
0.08 s		30	
0.15 s		23	
0.48 s		15	
4.2 s		7	
Initial rate of rise of on-state current, Exponential current ramp, Maximum ramp value < 200 A	di_{T}/dt	400	A/ μs
Junction temperature	T_{J}	-40 to +150	$^\circ\text{C}$
Storage temperature range	T_{stg}	-65 to +150	$^\circ\text{C}$

- NOTES: 1. See Applications Information and Figure 9 for voltage values at lower temperatures.
 2. Initially, the TISP4360H3BJ must be in thermal equilibrium with $T_{\text{J}} = 25\text{ }^\circ\text{C}$.
 3. The surge may be repeated after the TISP4360H3BJ returns to its initial conditions.
 4. See Applications Information and Figure 10 for current ratings at other temperatures.
 5. EIA/JESD51-2 environment and EIA/JESD51-3 PCB with standard footprint dimensions connected with 5 A rated printed wiring track widths. See Figure 7 for the current ratings at other durations. Derate current values at $-0.61\text{ }^\circ\text{C}$ for ambient temperatures above $25\text{ }^\circ\text{C}$.

Electrical Characteristics, $T_A = 25\text{ }^\circ\text{C}$ (Unless Otherwise Noted)

Parameter	Test Conditions	Min.	Typ.	Max.	Unit
I_{DRM} Repetitive peak off-state current	$V_{\text{D}} = V_{\text{DRM}}$ $T_{\text{A}} = 25\text{ }^\circ\text{C}$ $T_{\text{A}} = 85\text{ }^\circ\text{C}$			± 5 ± 10	μA
$V_{(\text{BO})}$ Breakover voltage	$dv/dt = \pm 750\text{ V/ms}$, $R_{\text{SOURCE}} = 300\ \Omega$			± 360	V
$V_{(\text{BO})}$ Impulse breakover voltage	$dv/dt \leq \pm 1000\text{ V}/\mu\text{s}$, Linear voltage ramp, Maximum ramp value = $\pm 500\text{ V}$ $di/dt = \pm 20\text{ A}/\mu\text{s}$, Linear current ramp, Maximum ramp value = $\pm 10\text{ A}$			± 372	V
$I_{(\text{BO})}$ Breakover current	$dv/dt = \pm 750\text{ V/ms}$, $R_{\text{SOURCE}} = 300\ \Omega$	± 0.15		± 0.8	A
V_{T} On-state voltage	$I_{\text{T}} = \pm 5\text{ A}$, $t_{\text{W}} = 100\ \mu\text{s}$			± 3	V
I_{H} Holding current	$I_{\text{T}} = \pm 5\text{ A}$, $di/dt = -/+ 30\text{ mA/ms}$	± 0.225		± 0.8	A
dv/dt Critical rate of rise of off-state voltage	Linear voltage ramp, Maximum ramp value < $0.85V_{\text{DRM}}$	± 5			kV/ μs
I_{D} Off-state current	$V_{\text{D}} = \pm 50\text{ V}$ $T_{\text{A}} = 85\text{ }^\circ\text{C}$			± 10	μA

JUNE 1999 - REVISED JANUARY 2007

Specifications are subject to change without notice.

Customers should verify actual device performance in their specific applications.

TISP4360H3BJ Overvoltage Protector Series

BOURNS®

Electrical Characteristics, $T_A = 25\text{ }^\circ\text{C}$ (Unless Otherwise Noted) (continued)

Parameter	Test Conditions	Min.	Typ.	Max.	Unit
C _{off} Off-state capacitance	f = 100 kHz, V _d = 1 V rms, V _D = 0,		70	84	pF
	f = 100 kHz, V _d = 1 V rms, V _D = -1 V		60	67	
	f = 100 kHz, V _d = 1 V rms, V _D = -2 V		55	62	
	f = 100 kHz, V _d = 1 V rms, V _D = -50 V		24	28	
	f = 100 kHz, V _d = 1 V rms, V _D = -100 V		22	26	

Thermal Characteristics

Parameter	Test Conditions	Min.	Typ.	Max.	Unit
R _{θJA} Junction to free air thermal resistance	EIA/JESD51-3 PCB, I _T = I _{TSM(1000)} , T _A = 25 °C, (see Note 6)			113	°C/W
	265 mm x 210 mm populated line card, 4-layer PCB, I _T = I _{TSM(1000)} , T _A = 25 °C		50		

NOTE 6: EIA/JESD51-2 environment and PCB has standard footprint dimensions connected with 5 A rated printed wiring track widths.

Parameter Measurement Information

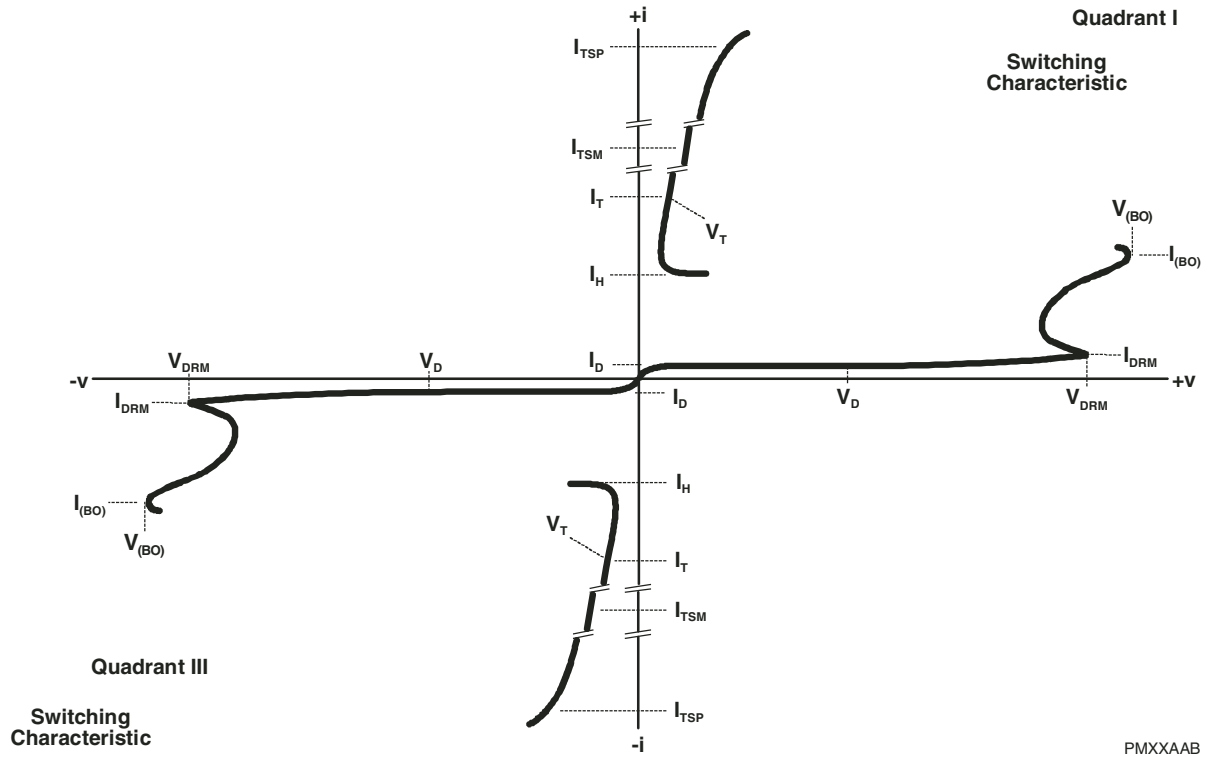

PMXXAAB

Figure 1. Voltage-current Characteristic for T and R Terminals
All Measurements are Referenced to the R Terminal

Typical Characteristics

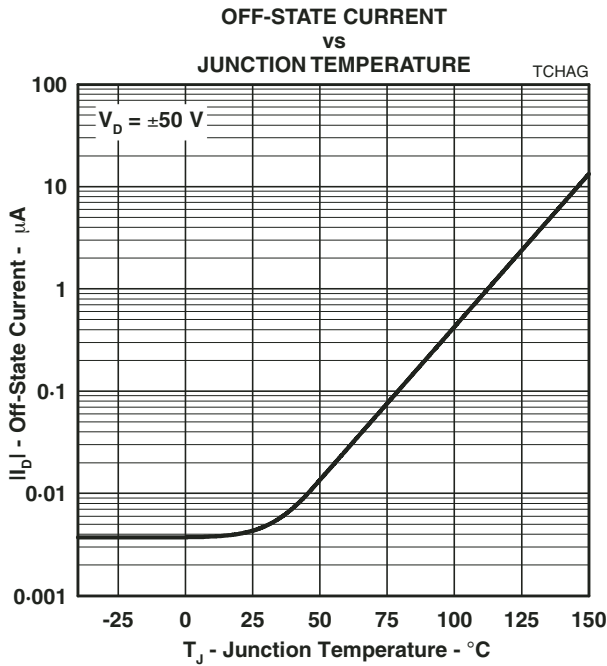

Figure 2.

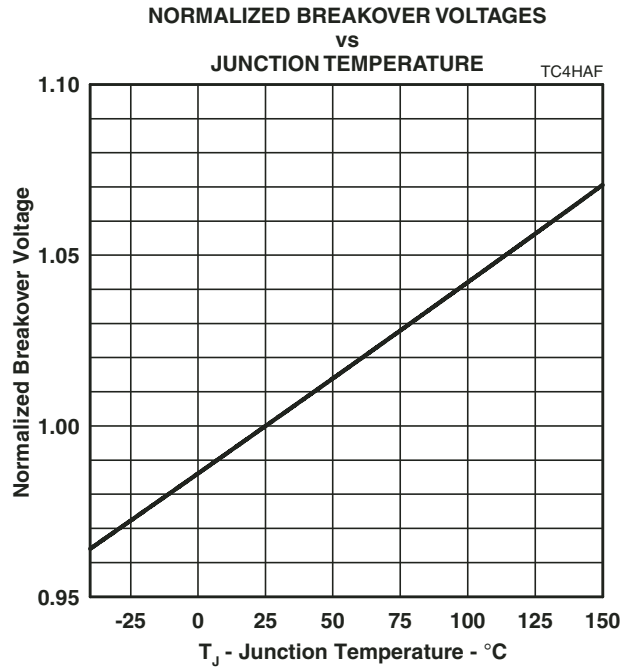

Figure 3.

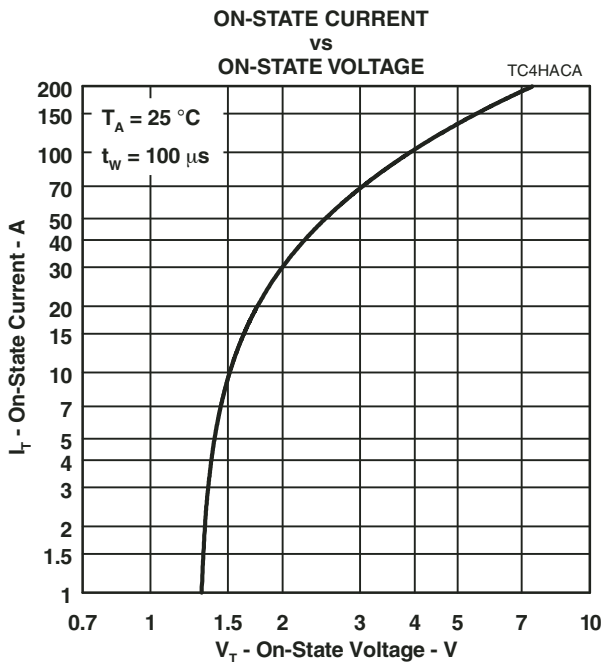

Figure 4.

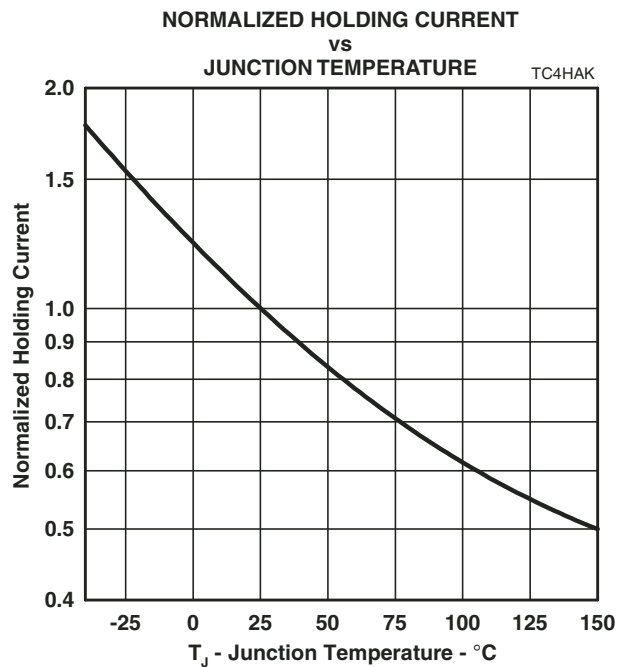

Figure 5.

Typical Characteristics

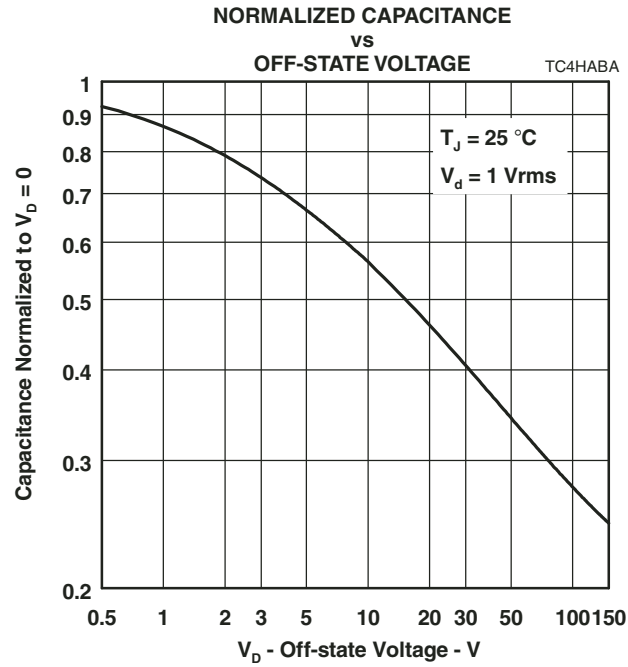
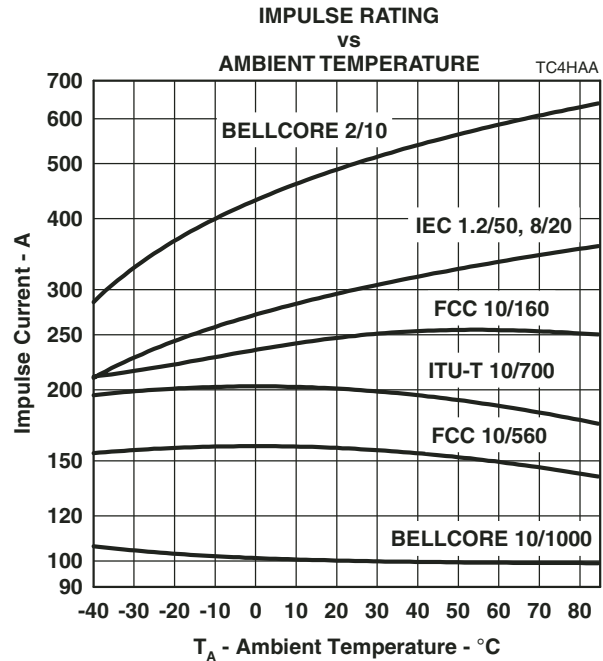
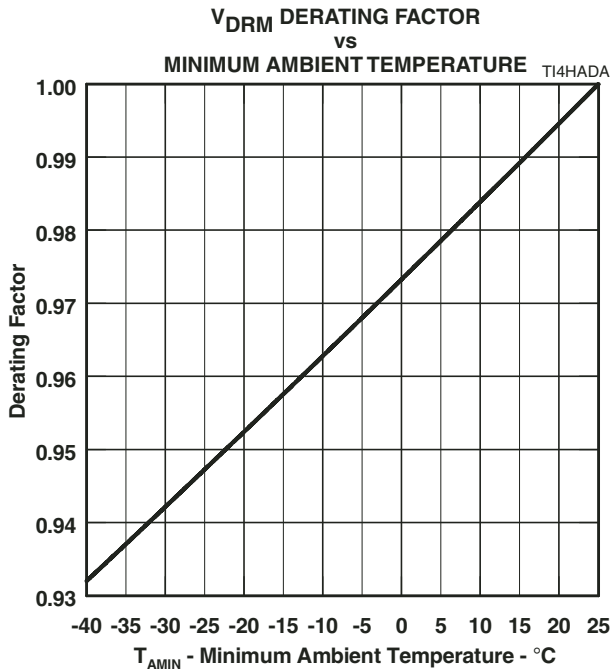
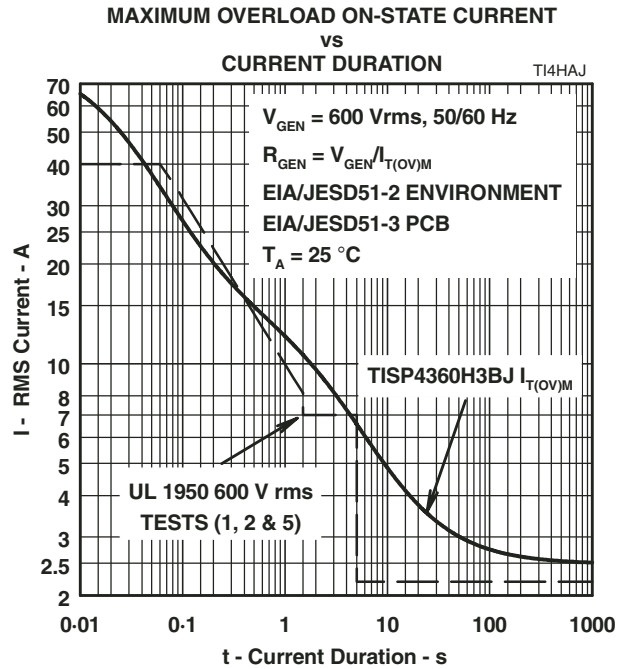
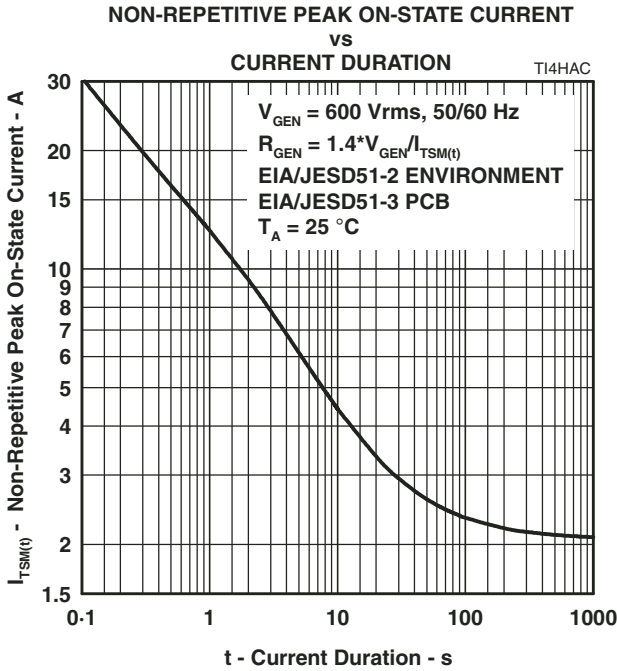

Figure 6.

Rating and Thermal Information



APPLICATIONS INFORMATION

Deployment

These devices are two terminal overvoltage protectors. They may be used either singly to limit the voltage between two conductors (Figure 11) or in multiples to limit the voltage at several points in a circuit (Figure 12).

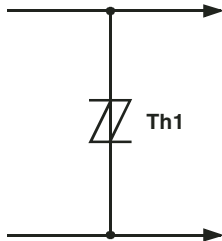

Figure 11. Two Point Protection

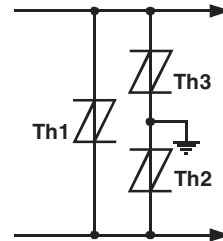

Figure 12. Multi-point Protection

In Figure 11, protector Th1 limits the maximum voltage between the two conductors to $\pm V_{(BO)}$. This configuration is normally used to protect circuits without a ground reference, such as modems. In Figure 12, protectors Th2 and Th3 limit the maximum voltage between each conductor and ground to the $\pm V_{(BO)}$ of the individual protector. Protector Th1 limits the maximum voltage between the two conductors to its $\pm V_{(BO)}$ value. If the equipment being protected has all its vulnerable components connected between the conductors and ground, then protector Th1 is not required.

Impulse Testing

To verify the withstand capability and safety of the equipment, standards require that the equipment is tested with various impulse wave forms. The table below shows some common values.

Standard	Peak Voltage Setting V	Voltage Waveform μs	Peak Current Value A	Current Waveform μs	TISP4360H3BJ 25 °C Rating A	Series Resistance Ω
GR-1089-CORE	2500	2/10	500	2/10	500	0
	1000	10/1000	100	10/1000	100	
FCC Part 68 (March 1998)	1500	10/160	200	10/160	250	0
	800	10/560	100	10/560	160	0
	1500	9/720 †	37.5	5/320 †	200	0
I3124	1000	9/720 †	25	5/320 †	200	0
	1500	0.5/700	37.5	0.2/310	200	0
ITU-T K.20/K.21	1500	10/700	37.5	5/310	200	0
	4000		100			

† FCC Part 68 terminology for the waveforms produced by the ITU-T recommendation K.21 10/700 impulse generator

Series resistance can be added to cover situations where either the TISP4360H3BJ current rating will be exceeded or excessive wiring currents result or both.

When a primary protector is used, the TISP4360H3BJ may operate before the primary protector. With the TISP4360H3BJ in a low voltage state, the primary protector is prevented from working. High currents, which should have been carried by the primary protector, now flow through the wiring to the equipment and through the TISP4360H3BJ. Interference and network equipment damage can occur, particularly if the currents are diverted to the local ground. Protector coordination prevents this problem. A series resistor can be used to develop a voltage drop large enough to activate the primary protector. If the primary protector was a gas discharge tube (GDT) with a maximum d.c. sparkover of 400 V and the typical lightning impulse decay time was several hundred microseconds (TISP4360H3BJ rating 200 A), a 2 Ω series resistor (400 V/200 A) would be sufficient to achieve coordination. At peak currents of 200 A and above, the resistor would develop at least 400 V and GDT would switch and divert the current.

APPLICATIONS INFORMATION

Impulse Testing (continued)

If the impulse generator current exceeds the protector's current rating, then a series resistance can be used to reduce the current to the protector's rated value to prevent possible failure. The required value of series resistance for a given waveform is given by the following calculations. First, the minimum total circuit impedance is found by dividing the impulse generator's peak voltage by the protector's rated current. The impulse generator's fictive impedance (generator's peak voltage divided by peak short circuit current) is then subtracted from the minimum total circuit impedance to give the required value of series resistance. In some cases, the equipment will require verification over a temperature range. By using the rated waveform values from Figure 10, the appropriate series resistor value can be calculated for ambient temperatures in the range of -40 °C to 85 °C.

AC Testing

The protector can withstand currents applied for times not exceeding those shown in Figure 7. Currents that exceed these times must be terminated or reduced to avoid protector failure. Fuses, PTC (Positive Temperature Coefficient) resistors and fusible resistors are overcurrent protection devices which can be used to reduce the current flow. Protective fuses may range from a few hundred milliamperes to one ampere. In some cases, it may be necessary to add some extra series resistance to prevent the fuse from opening during impulse testing. The current versus time characteristic of the overcurrent protector must be below the line shown in Figure 7. In some cases, there may be a further time limit imposed by the test standard (e.g. UL 1459/1950 wiring simulator failure).

Safety tests require that the equipment fails without any hazard to the user. For the equipment protector, this condition usually means that the fault mode is short circuit, ensuring that the following circuitry is not exposed to high voltages. The ratings table and Figure 8 detail the earliest times when a shorted condition could occur. Figure 8 shows how the protector current levels compare to UL 1950 levels. Only the UL 1950 600 V tests (1, 2 and 3) are shown, as these have sufficient voltage to operate the protector. Tests 4 (<285 V peak, 2.2 A) and 5 (120 V rms, 25 A) are too low in voltage to operate the protector.

Figure 8 shows that the TISP4360H3BJ curve is very close or better than the UL 1950 test levels. Design compliance is simply a matter of selecting an overcurrent protector which operates before the UL 1950 times up to 1.5 s. Fuses such as the Littelfuse® 436 series and 2AG (Surge Withstand type) series have a 600 V capability for UL 1950. Fuses rated in the range of 0.5 A to 1.5 A will usually meet the safety test requirements. However, the lower rated current value fuses may open on the type A surges of FCC Part 68. Opening on a type A surge is not a test failure, but opening on a type B surge (37.5 A 5/320) is; so the selected fuse must be able to withstand the type B surge.

Capacitance

The protector characteristic off-state capacitance values are given for d.c. bias voltage, V_D , values of 0, -1 V, -2 V, -50 V and -100 V. Values for other voltages may be calculated by multiplying the $V_D = 0$ capacitance value by the factor given in Figure 6. Up to 10 MHz, the capacitance is essentially independent of frequency. Above 10 MHz, the effective capacitance is strongly dependent on connection inductance.

Normal System Voltage Levels

The protector should not clip or limit the voltages that occur in normal system operation. If the maximum system voltages are not known, then designers often used the voltages for the FCC Part 68 "B" ringer. The "B" ringer has a d.c. voltage of 56.5 and a maximum a.c. ring voltage of 150 V rms. The resultant waveform is shown in Figure 13. The maximum voltage is -269 V, but, because of possible wiring reversals, the protector should have a working voltage of ± 269 V minimum. The standard TISP4350H3BJ protector meets this requirement with a working voltage, V_{DRM} , of ± 275 V and a protection voltage, $V_{(BO)}$, of ± 350 V. Figure 14 shows the TISP4350H3BJ voltages relative to the POTS -269 V peak ringing voltage.

The ADSL signal can be as high as ± 15 V and this adds to the POTS signal, making a peak value of -284 V. This increased signal value of -284 V would be clipped by the TISP4350H3BJ, which only allows for a -275 V signal. The TISP4360H3BJ has been specified to overcome this problem by having a higher working voltage of ± 290 V. Figure 15 shows the TISP4360H3BJ voltages relative to the -284 V peak ADSL plus POTS ringing voltage. The ± 15 V ADSL signal is shown as a grey band in Figure 15.

The recommended PCB pad layout for the TISP4360H3BJ SMB package (see mechanical section) gives a creepage distance of 2.54 mm between the device terminals. This distance value allows compliance to the minimum clearance values required by UL 1950 for operational, basic and supplementary insulation and creepage values for pollution degree 1.

APPLICATIONS INFORMATION

Normal System Voltage Levels

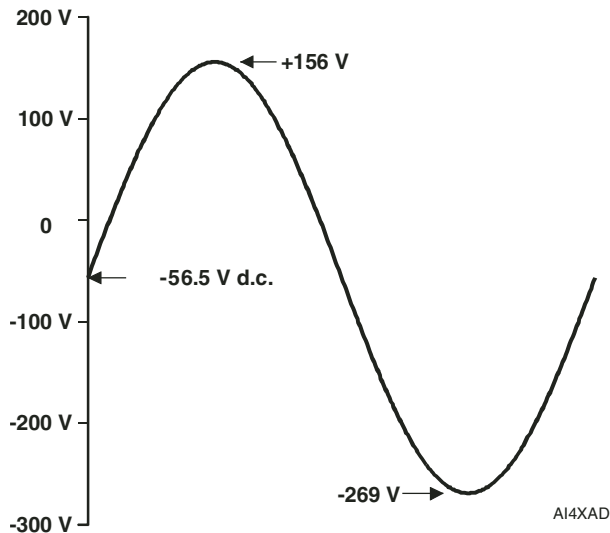

Figure 13.

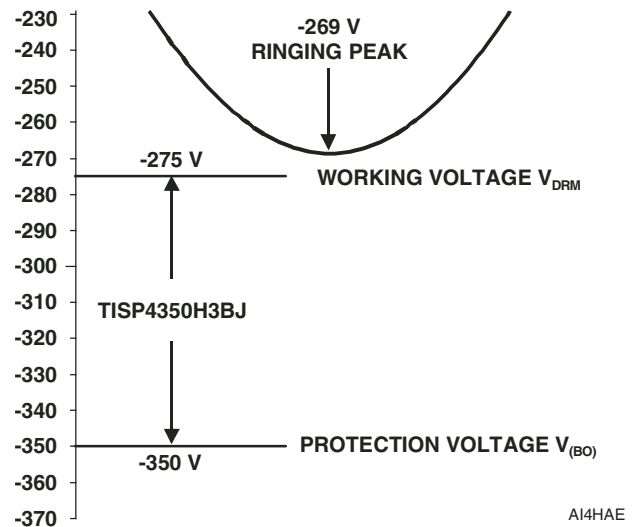

Figure 14.

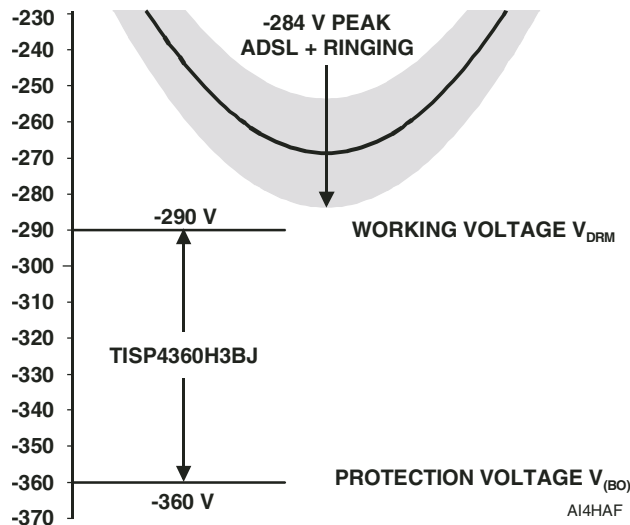

Figure 15.

JESD51 Thermal Measurement Method

To standardize thermal measurements, the JEDEC has created the JESD51 standard. Part 2 of the standard (JESD51-2, 1995) describes the test environment. This is a 0.0283 m³ (1 ft³) cube which contains the test PCB (Printed Circuit Board) horizontally mounted at the center. Part 3 of the standard (JESD51-3, 1996) defines two test PCBs for surface mount components; one for packages smaller than 27 mm (1.06 ") on a side and the other for packages up to 48 mm (1.89 "). The SMBJ measurements used the smaller 76.2 mm x 114.3 mm (3.0 " x 4.5 ") PCB. The JESD51-3 PCBs are designed to have low effective thermal conductivity (high thermal resistance) and represent a worse case condition. The PCBs used in the majority of applications will achieve lower values of thermal resistance and so can dissipate higher power levels than indicated by the JESD51 values.

JUNE 1999 - REVISED JANUARY 2007

Specifications are subject to change without notice.

Customers should verify actual device performance in their specific applications.

Typical Circuits

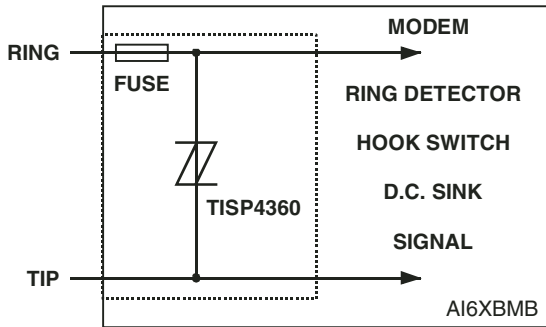

Figure 16. Modem Inter-wire Protection

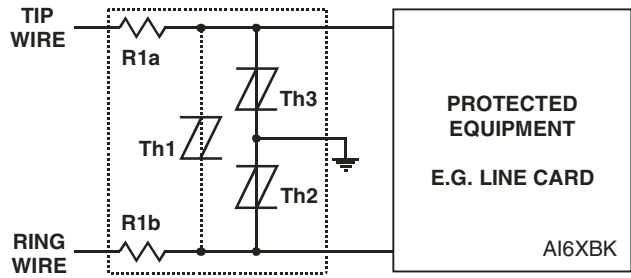

Figure 17. Protection Module

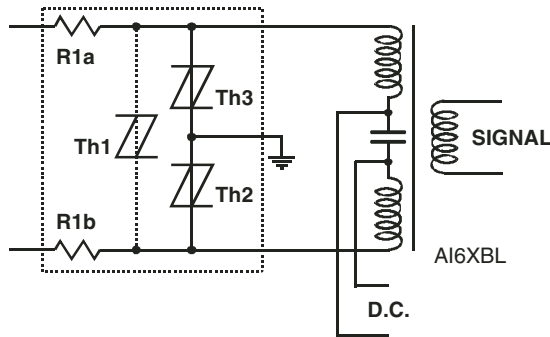

Figure 18. ISDN Protection

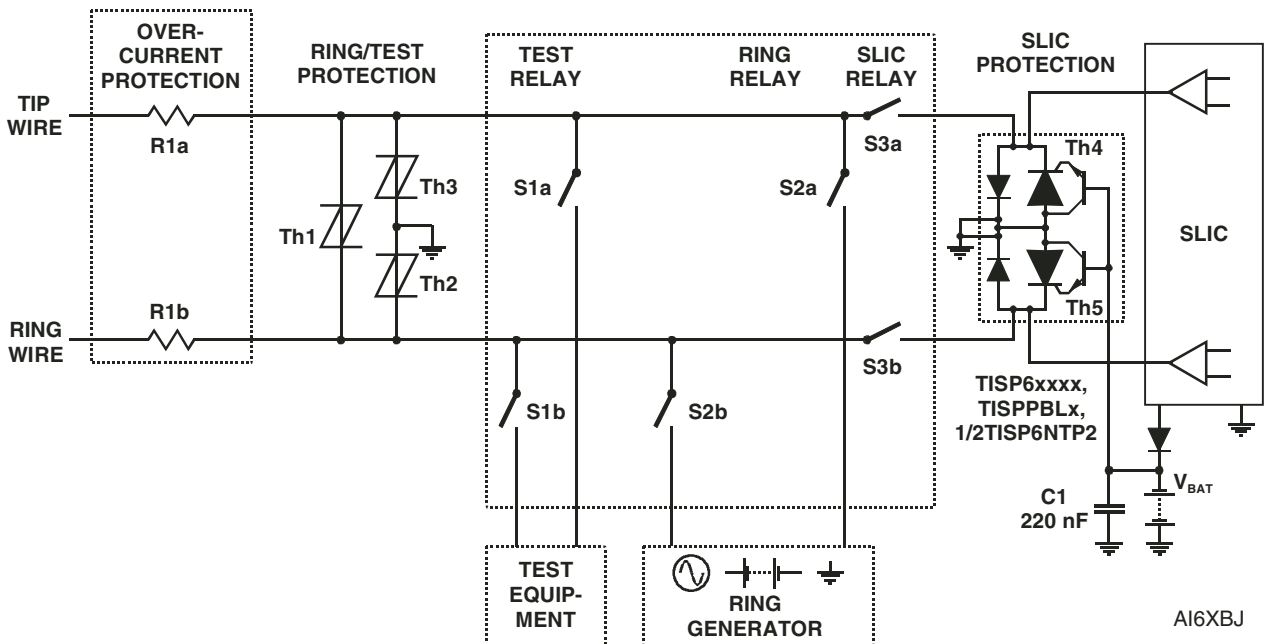

Figure 19. Line Card Ring/Test Protection

TISP4360H3BJ Overvoltage Protector Series

BOURNS®

MECHANICAL DATA

Recommended Printed Wiring Footprint

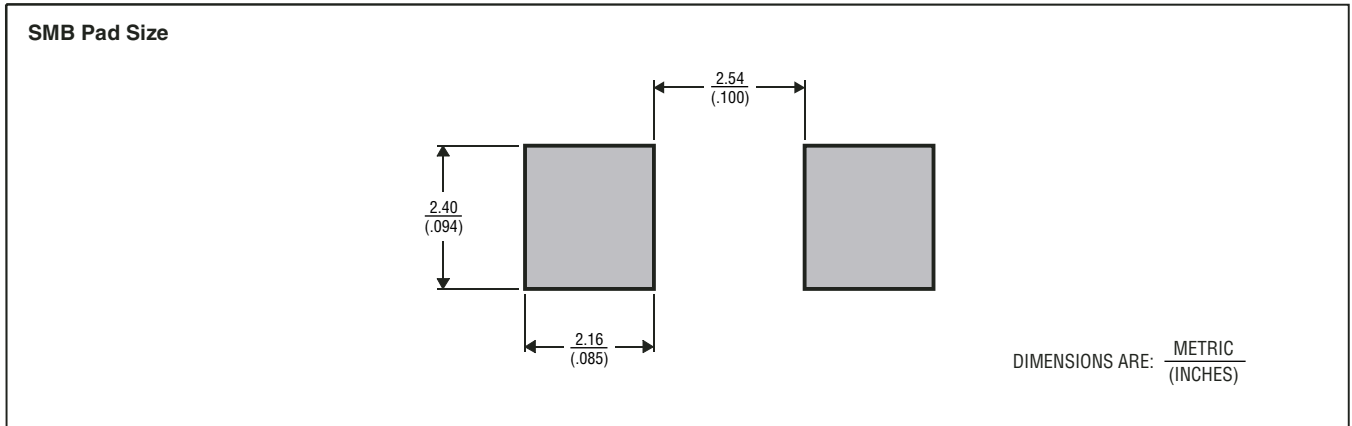

MDXXBI

Device Symbolization Code

Devices will be coded as below. As the device parameters are symmetrical, terminal 1 is not identified.

Device	Symbolization Code
TISP4360H3BJ	4360H3

Carrier Information

Devices are shipped in one of the carriers below. Unless a specific method of shipment is specified by the customer, devices will be shipped in the most practical carrier. For production quantities, the carrier will be embossed tape reel pack. Evaluation quantities may be shipped in bulk pack or embossed tape.

Carrier	Order As
Embossed Tape Reel Pack	TISP4360H3BJR-S
Bulk Pack	TISP4360H3BJ-S

"TISP" is a trademark of Bourns, Ltd., a Bourns Company, and is Registered in U.S. Patent and Trademark Office.
"Bourns" is a registered trademark of Bourns, Inc. in the U.S. and other countries.

JUNE 1999 - REVISED JANUARY 2007

Specifications are subject to change without notice.

Customers should verify actual device performance in their specific applications.

Looking for pricing, stock, or lifecycle information?

Click below to explore more details on WIN SOURCE:

- ⊖ [View TISP4360H3BJR on WIN SOURCE](#)
- ⊖ [Bourns Inc. Information](#)

Optimize Your Supply Chain with WIN SOURCE Solutions

- ✓ Global Sourcing Solution
- ✓ Obsolete Management
- ✓ Cost Control Management
- ✓ Shortage Management
- ✓ Alternative Solution
- ✓ Excess Inventory Management