

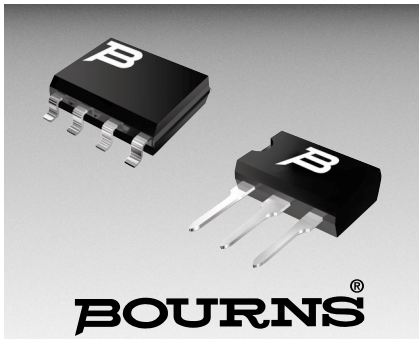

**THE DATASHEET OF
TISP1072F3SL**



DUAL FORWARD-CONDUCTING UNIDIRECTIONAL THYRISTOR OVERVOLTAGE PROTECTORS



BOURNS®

TISP1xxx F3 Overvoltage Protector Series

**Ion-Implanted Breakdown Region
Precise and Stable Voltage
Low Voltage Overshoot under Surge**

DEVICE	V _{DRM} V	V _(BO) V
'1072F3	- 58	- 72
'1082F3	- 66	- 82

**Planar Passivated Junctions
Low Off-State Current <10 μA**

Rated for International Surge Wave Shapes

Waveshape	Standard	I _{TSP} A
2/10 μs	GR-1089-CORE	80
8/20 μs	IEC 61000-4-5	70
10/160 μs	FCC Part 68	60
10/700 μs	ITU-T K.20/21 FCC Part 68	50
10/560 μs	FCC Part 68	45
10/1000 μs	GR-1089-CORE	35

UL Recognized Component

Description

These dual forward-conducting unidirectional over-voltage protectors are designed for the overvoltage protection of ICs used for the SLIC (Subscriber Line Interface Circuit) function. The IC line driver section is typically powered with 0 V and a negative supply. The TISP1xxx F3 limits voltages that exceed these supply rails and is offered in two voltage variants to match typical negative supply voltage values.

High voltages can occur on the line as a result of exposure to lightning strikes and a.c. power surges. Negative transients are initially limited by breakdown clamping until the voltage rises to the breakover level, which causes the device to crowbar. The high crowbar holding current prevents d.c. latchup as the current subsides. Positive transients are limited by diode forward conduction. These protectors are guaranteed to suppress and withstand the listed international lightning surges on any terminal pair.

How To Order

Device	Package	Carrier	Order As
TISP1xxx F3	D, Small-outline	Tape And Reeled	TISP1xxx F3DR
	P, Plastic Dip	Tube	TISP1xxx F3P
	SL, Single-in-line	Tube	TISP1xxx F3SL

Insert xxx value corresponding to protection voltages of 072 and 082

D Package (Top View)

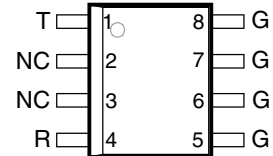

NC - No internal connection

P Package (Top View)

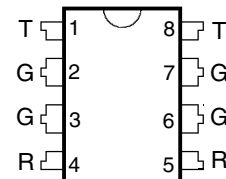

Specified T terminal ratings require connection of pins 1 and 8.
Specified R terminal ratings require connection of pins 4 and 5.

SL Package (Top View)

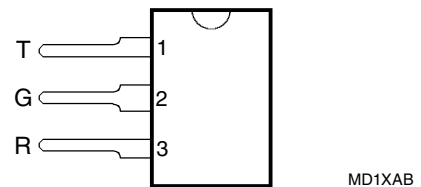

Device Symbol

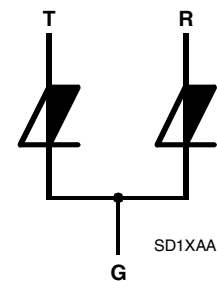

Terminals T, R and G correspond to the alternative line designators of A, B and C

TISP1xxF3 Overvoltage Protector Series

BOURNS®

Description (continued)

High voltages can occur on the line as a result of exposure to lightning strikes and a.c. power surges. Negative transients are initially limited by breakdown clamping until the voltage rises to the breakover level, which causes the device to crowbar. The high crowbar holding current prevents d.c. latchup as the current subsides. Positive transients are limited by diode forward conduction. These protectors are guaranteed to suppress and withstand the listed international lightning surges on any terminal pair.

These monolithic protection devices are fabricated in ion-implanted planar structures to ensure precise and matched breakover control and are virtually transparent to the system in normal operation.

Absolute Maximum Ratings, $T_A = 25\text{ }^\circ\text{C}$ (Unless Otherwise Noted)

Rating	Symbol	Value	Unit
Repetitive peak off-state voltage, $0\text{ }^\circ\text{C} < T_A < 70\text{ }^\circ\text{C}$	V_{DRM}	-58 -66	V
Non-repetitive peak on-state pulse current (see Notes 1 and 2)	I_{PPSM}	120 80 50 70 60 55 38 50 50 45 35	A
1/2 (Gas tube differential transient, 1/2 voltage wave shape)			
2/10 (Telcordia GR-1089-CORE, 2/10 voltage wave shape)			
1/20 (ITU-T K.22, 1.2/50 voltage wave shape, 25 Ω resistor)			
8/20 (IEC 61000-4-5, combination wave generator, 1.2/50 voltage wave shape)			
10/160 (FCC Part 68, 10/160 voltage wave shape)			
4/250 (ITU-T K.20/21, 10/700 voltage wave shape, simultaneous)			
0.2/310 (CNET I 31-24, 0.5/700 voltage wave shape)			
5/310 (ITU-T K.20/21, 10/700 voltage wave shape, single)			
5/320 (FCC Part 68, 9/720 voltage wave shape, single)			
10/560 (FCC Part 68, 10/560 voltage wave shape)			
10/1000 (Telcordia GR-1089-CORE, 10/1000 voltage wave shape)			
Non-repetitive peak on-state current, $0\text{ }^\circ\text{C} < T_A < 70\text{ }^\circ\text{C}$ (see Notes 1 and 3) 50 Hz, 1 s	I_{TSM}	4.3 5.7 7.1	A
		D Package P Package SL Package	
Initial rate of rise of on-state current, Linear current ramp, Maximum ramp value $< 38\text{ A}$	di_T/dt	250	A/ μs
Junction temperature	T_J	-65 to +150	$^\circ\text{C}$
Storage temperature range	T_{stg}	-65 to +150	$^\circ\text{C}$

NOTES: 1. Further details on surge wave shapes are contained in the Applications Information section.

2. Initially the TISP® must be in thermal equilibrium with $0\text{ }^\circ\text{C} < T_J < 70\text{ }^\circ\text{C}$. The surge may be repeated after the TISP® returns to its initial conditions.

3. Above $70\text{ }^\circ\text{C}$, derate linearly to zero at $150\text{ }^\circ\text{C}$ lead temperature.

Electrical Characteristics for R and T Terminal Pair, $T_A = 25\text{ }^\circ\text{C}$ (Unless Otherwise Noted)

Parameter	Test Conditions	Min	Typ	Max	Unit
I_{DRM} Repetitive peak off-state current	$V_D = \pm V_{\text{DRM}}$, $0\text{ }^\circ\text{C} < T_A < 70\text{ }^\circ\text{C}$			± 10	μA
I_D Off-state current	$V_D = \pm 50\text{ V}$			± 10	μA
C_{off} Off-state capacitance	$f = 100\text{ kHz}$, $V_d = 100\text{ mV}$ $V_D = 0$ (see Note 4)		0.08 0.06 0.02	0.5 0.4 0.3	pF
			D Package P Package SL Package		

NOTE 4: Further details on capacitance are given in the Applications Information section.

TISP1xxxF3 Overvoltage Protector Series



Electrical Characteristics for T and G or R and G Terminals, $T_A = 25\text{ }^\circ\text{C}$ (Unless Otherwise Noted)

Parameter	Test Conditions	Min	Typ	Max	Unit
I_{DRM} Repetitive peak off-state current	$V_D = V_{DRM}$, $0\text{ }^\circ\text{C} < T_A < 70\text{ }^\circ\text{C}$			-10	μA
$V_{(BO)}$ Breakover voltage	$dv/dt = -250\text{ V/ms}$, $R_{SOURCE} = 300\ \Omega$			-72 -82	V
$V_{(BO)}$ Impulse breakover voltage	$dv/dt \leq -1000\text{ V}/\mu\text{s}$, Linear voltage ramp, Maximum ramp value = -500 V $R_{SOURCE} = 50\ \Omega$			-78 -92	V
$I_{(BO)}$ Breakover current	$dv/dt = -250\text{ V/ms}$, $R_{SOURCE} = 300\ \Omega$	-0.1		-0.6	A
V_{FRM} Peak forward recovery voltage	$dv/dt \leq +1000\text{ V}/\mu\text{s}$, Linear voltage ramp, Maximum ramp value = +500 V $R_{SOURCE} = 50\ \Omega$			3.3 3.3	V
V_T On-state voltage	$I_T = -5\text{ A}$, $t_W = 100\ \mu\text{s}$			-3	V
V_F On-state voltage	$I_T = +5\text{ A}$, $t_W = 100\ \mu\text{s}$			+3	V
I_H Holding current	$I_T = -5\text{ A}$, $di/dt = +30\text{ mA/ms}$	-0.15			A
dv/dt Critical rate of rise of off-state voltage	Linear voltage ramp, Maximum ramp value $< 0.85V_{DRM}$	-5			$\text{kV}/\mu\text{s}$
I_D Off-state current	$V_D = -50\text{ V}$			-10	μA
C_{off} Off-state capacitance	$f = 1\text{ MHz}$, $V_d = 0.1\text{ V r.m.s.}$, $V_D = 0$			150 240	pF
	$f = 1\text{ MHz}$, $V_d = 0.1\text{ V r.m.s.}$, $V_D = -5\text{ V}$			130 240	
	$f = 1\text{ MHz}$, $V_d = 0.1\text{ V r.m.s.}$, $V_D = -50\text{ V}$			65 104	
	$f = 1\text{ MHz}$, $V_d = 0.1\text{ V r.m.s.}$, $V_D = -50\text{ V}$ (see Note 4)			55 104 30 48 25 48	

NOTE 5: Further details on capacitance are given in the Applications Information section.

Thermal Characteristics

Parameter	Test Conditions	Min	Typ	Max	Unit
$R_{\theta JA}$ Junction to free air thermal resistance	$P_{tot} = 0.8\text{ W}$, $T_A = 25\text{ }^\circ\text{C}$ 5 cm^2 , FR4 PCB	D Package		160	$^\circ\text{C}/\text{W}$
		P Package		100	
		SL Package		135	

Parameter Measurement Information

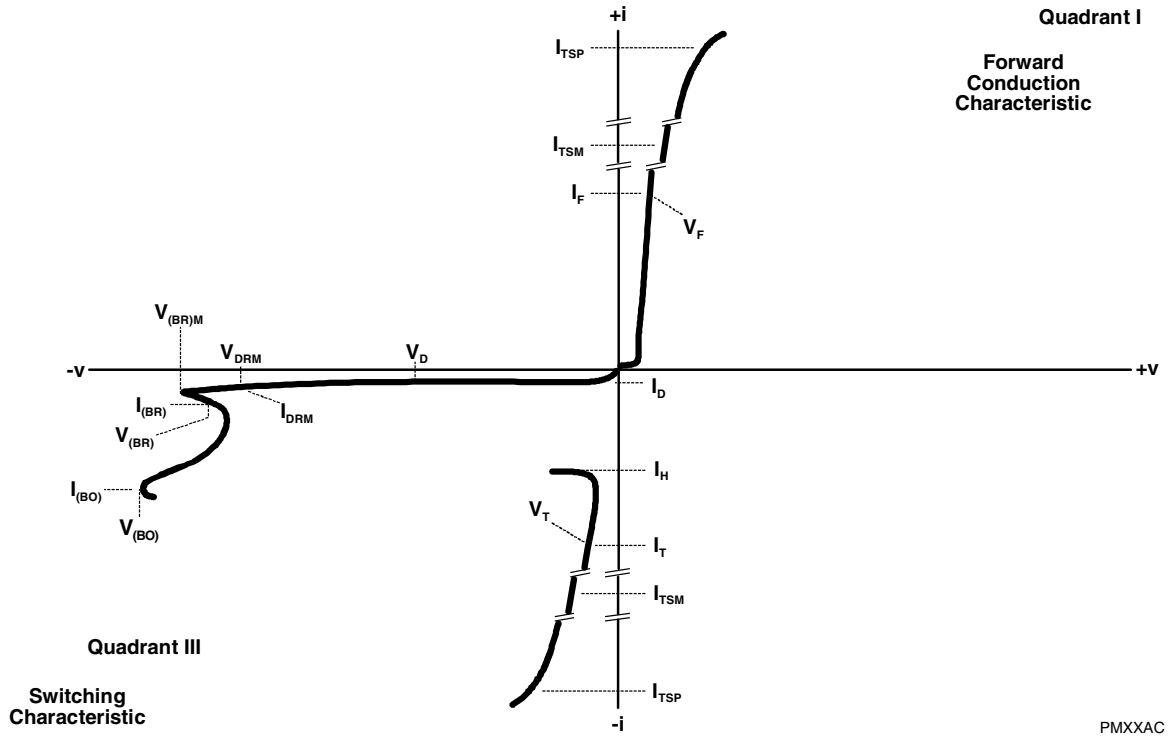

Figure 1. Voltage-current Characteristic for Terminals R and G or T and G

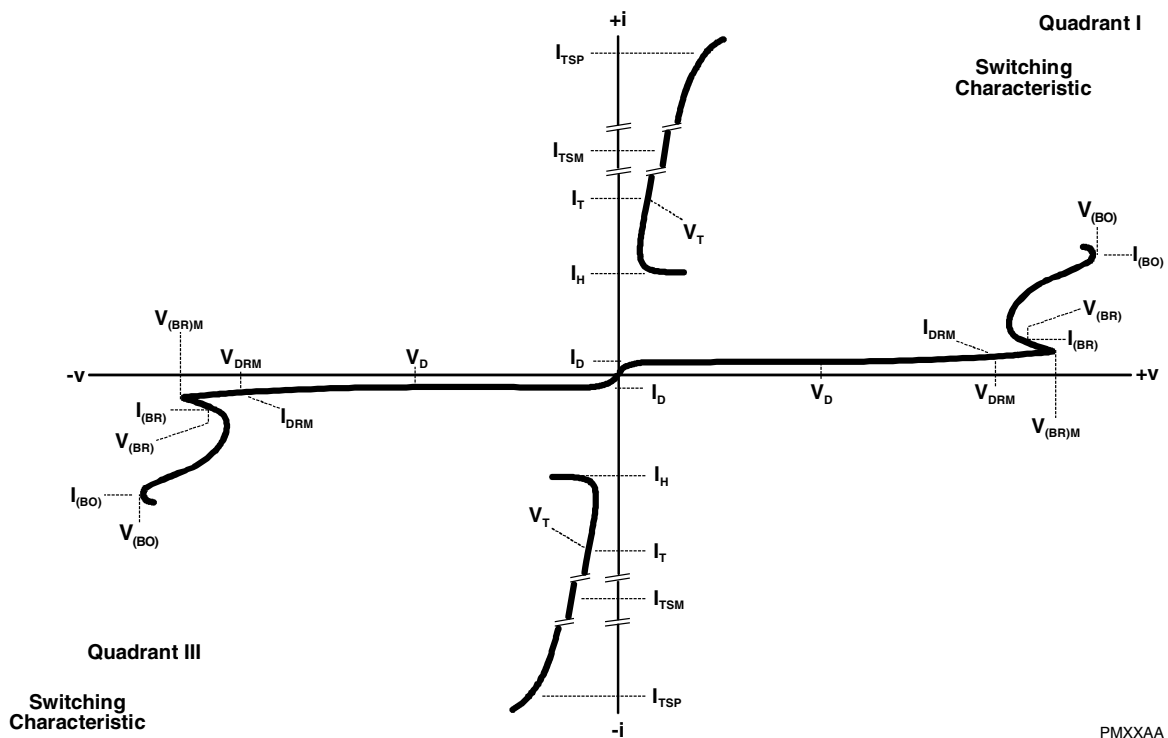

Figure 2. Voltage-current Characteristic for Terminals R and T

Typical Characteristics - R and G or T and G Terminals

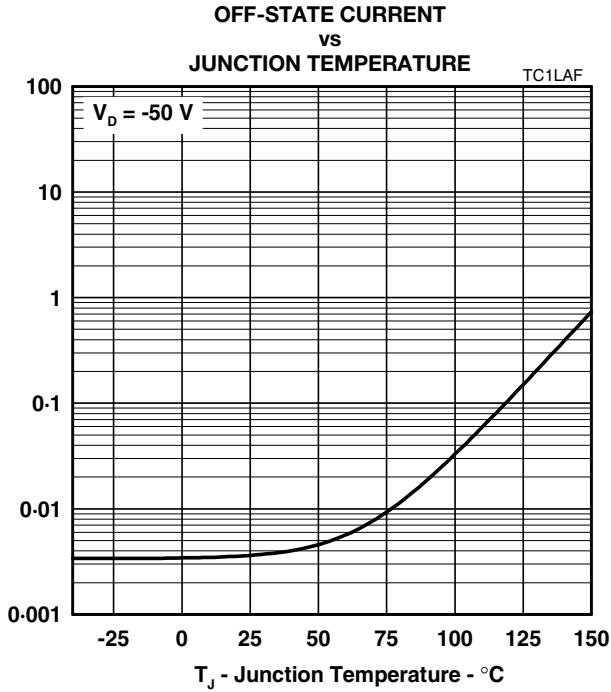

Figure 3.

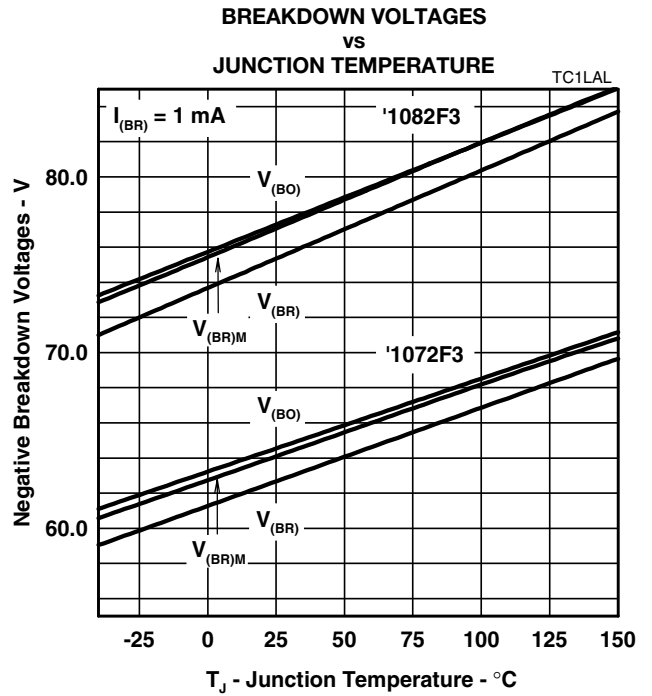

Figure 4.

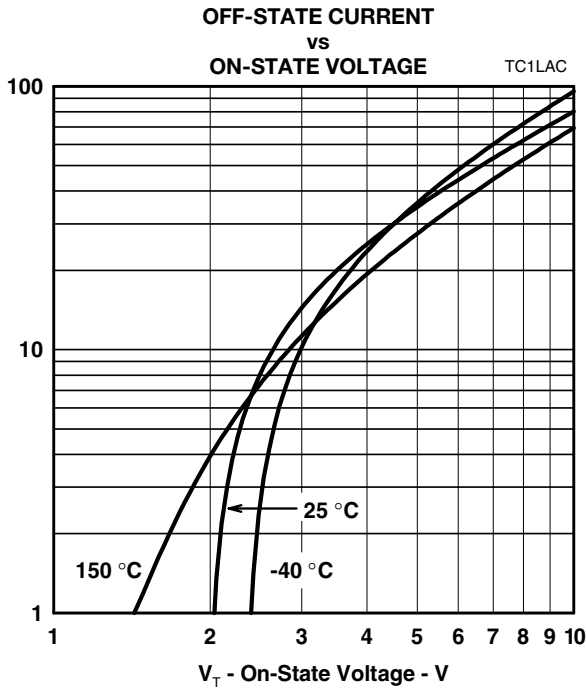

Figure 5.

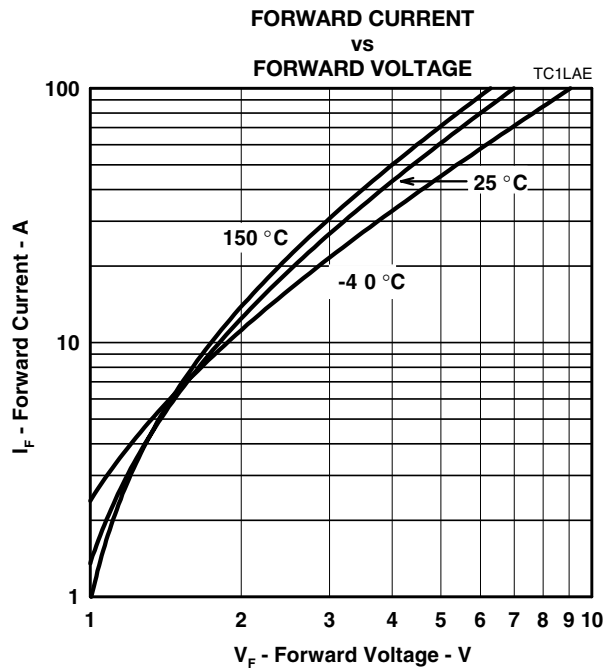

Figure 6.

Typical Characteristics - R and G or T and G Terminals

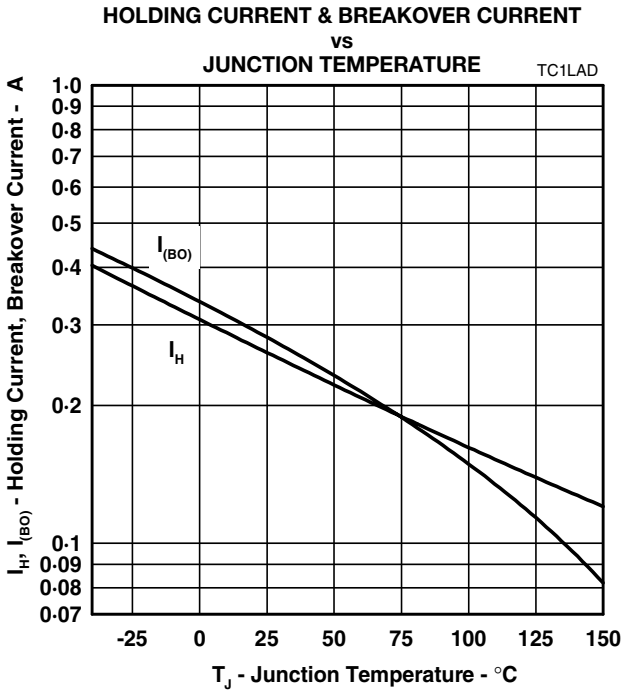

Figure 7.

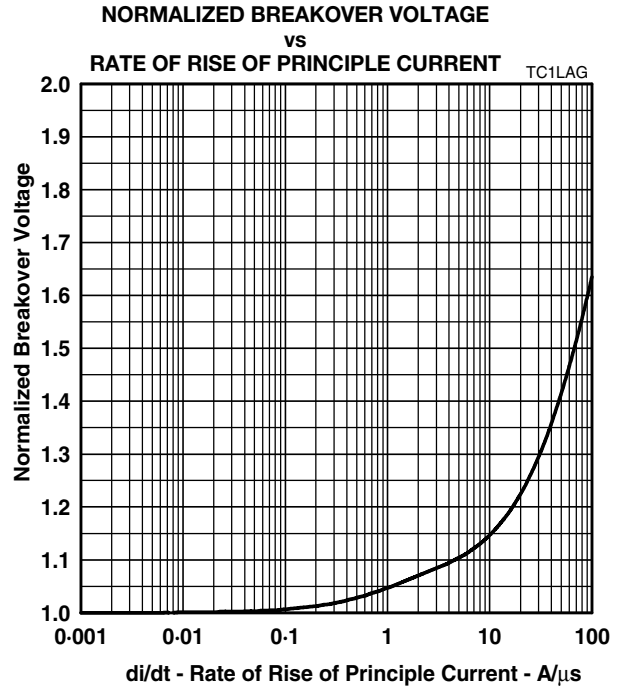

Figure 8.

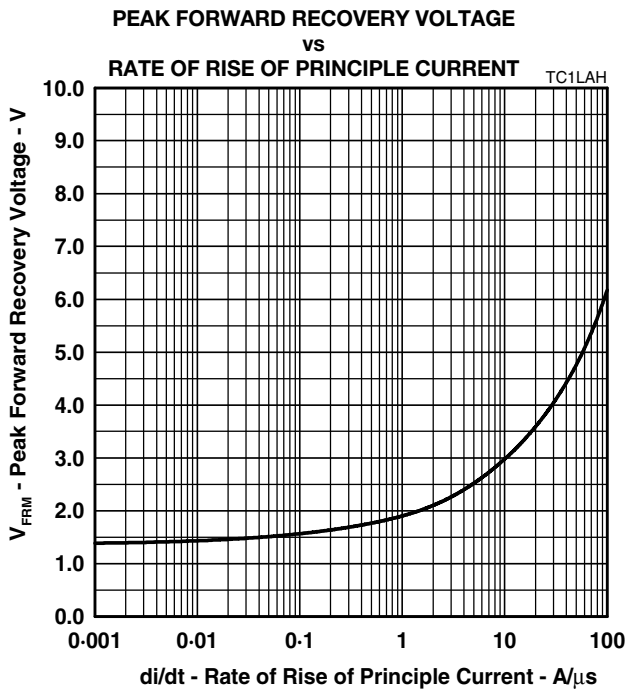

Figure 9.

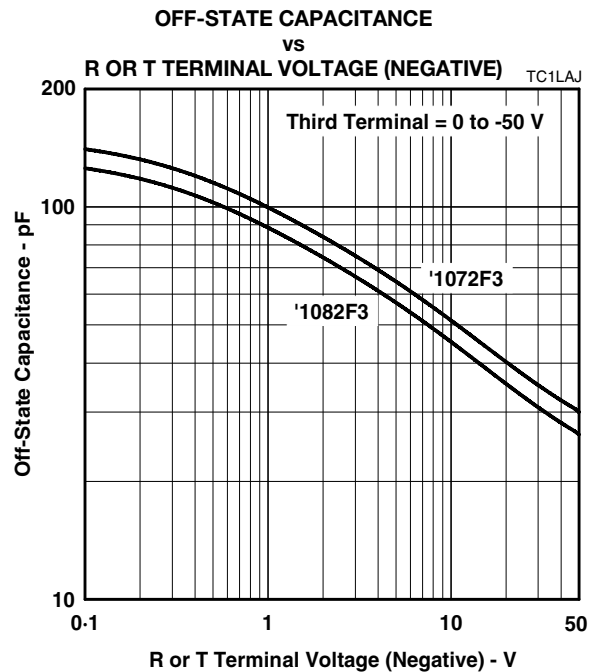

Figure 10.

Typical Characteristics - R and G or T and G Terminals

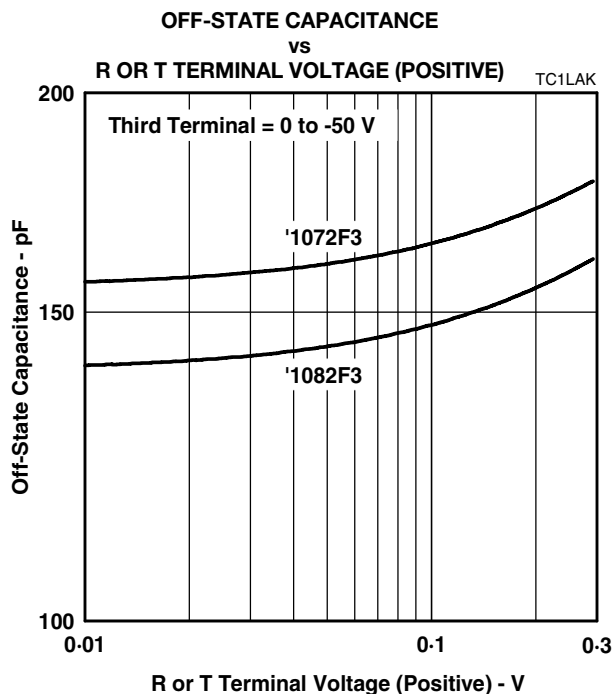

Figure 11.

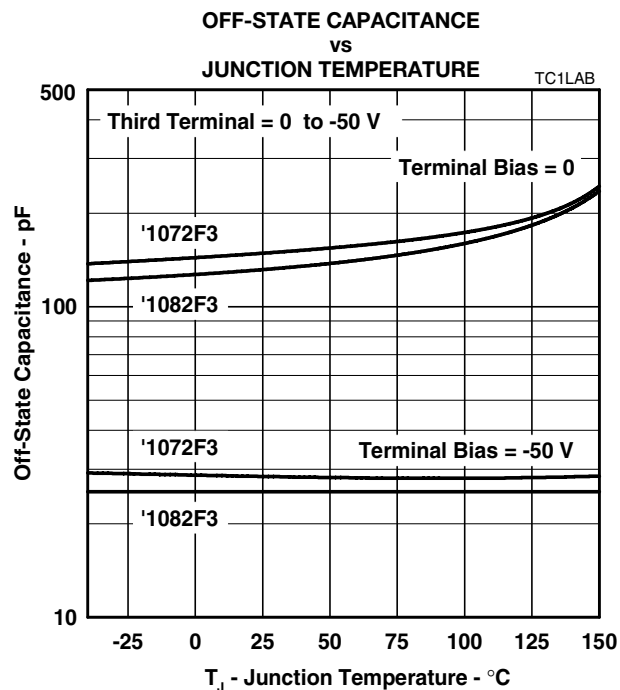

Figure 12.

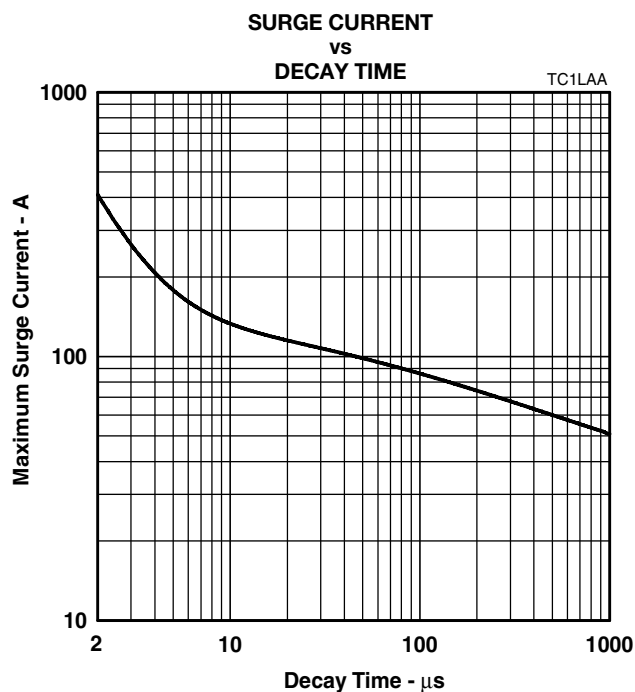

Figure 13.

Typical Characteristics - R and T Terminals

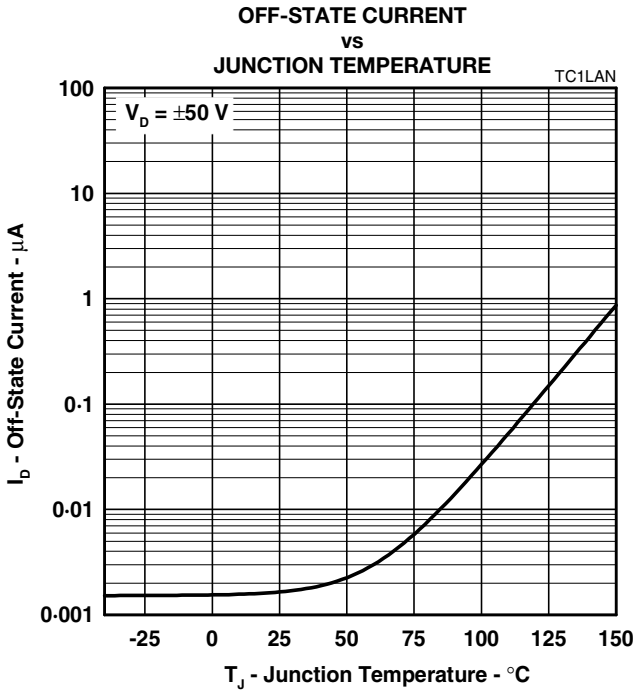

Figure 14.

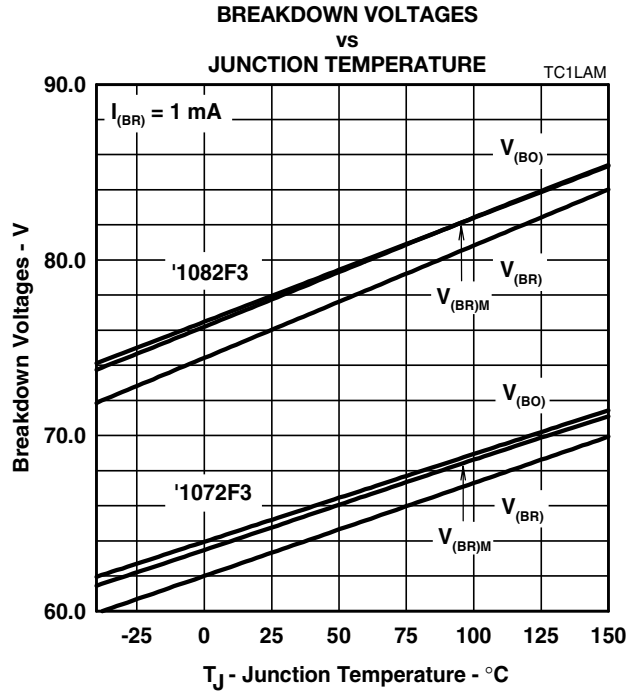

Figure 15.

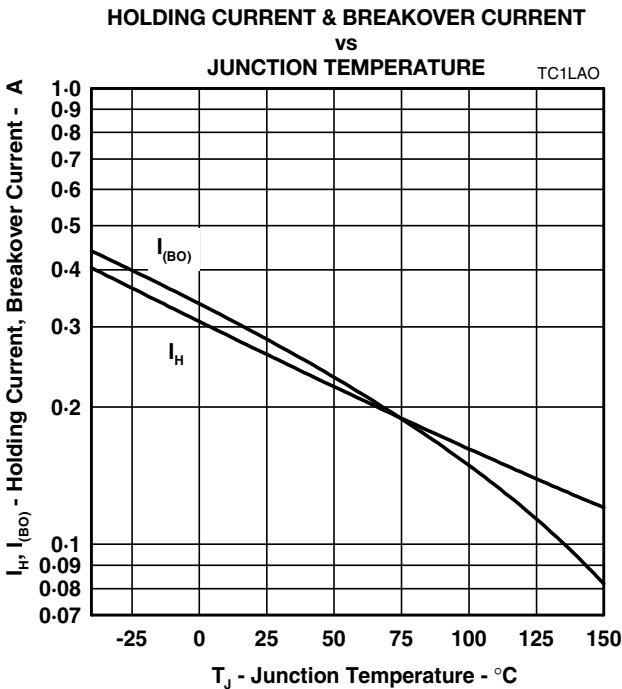

Figure 16.

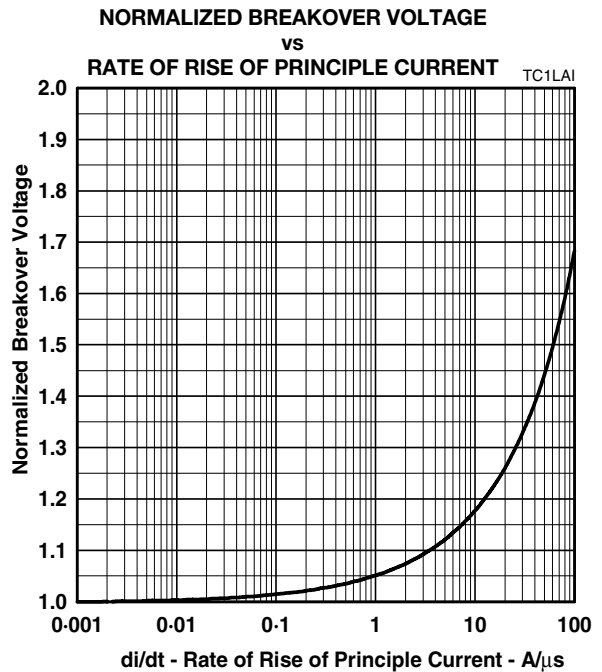
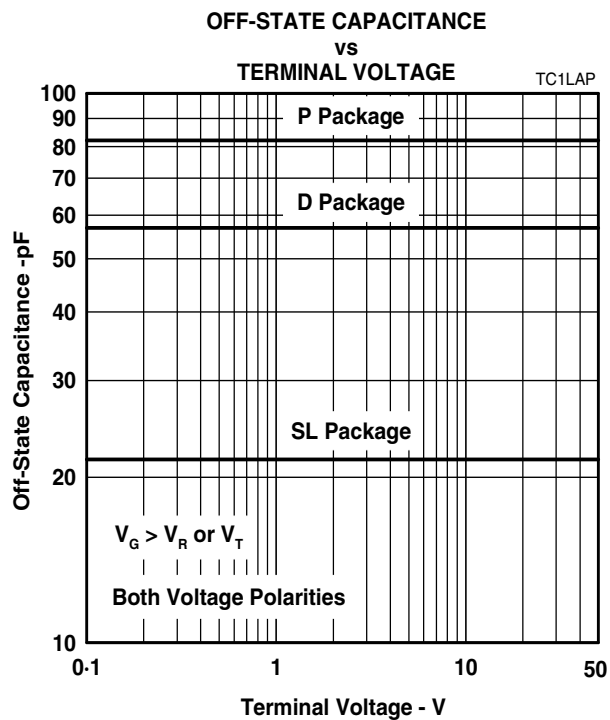
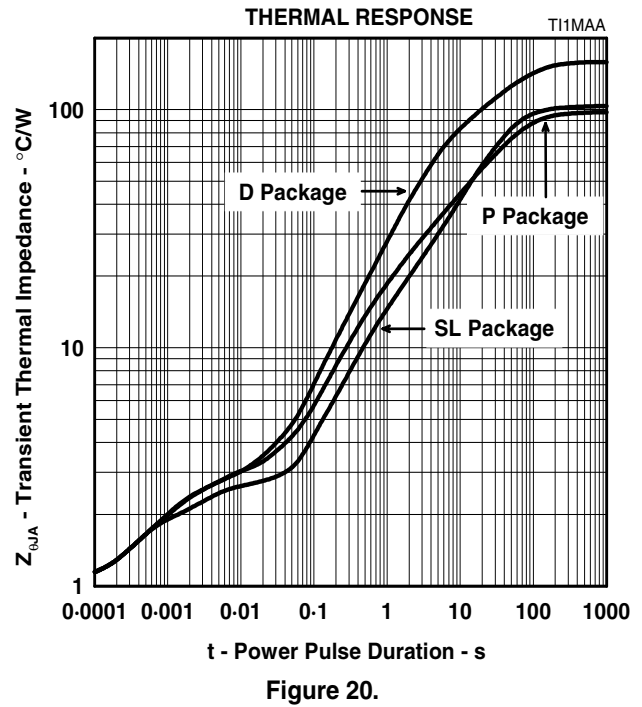
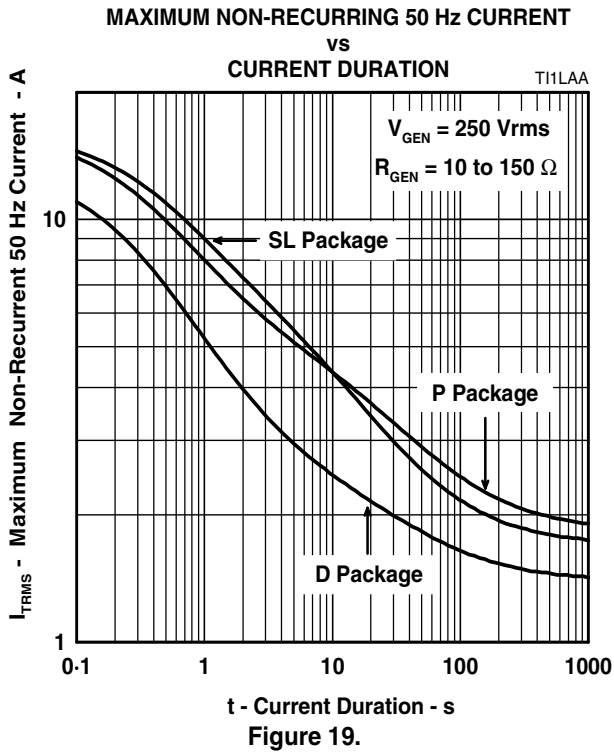

Figure 17.

Typical Characteristics - R and T Terminals



Thermal Information



APPLICATIONS INFORMATION

Electrical Characteristics

The electrical characteristics of a TISP[®] device are strongly dependent on junction temperature, T_J . Hence, a characteristic value will depend on the junction temperature at the instant of measurement. The values given in this data sheet were measured on commercial testers, which generally minimize the temperature rise caused by testing. Application values may be calculated from the parameters' temperature coefficient, the power dissipated and the thermal response curve, Z_{θ} (see M. J. Maytum, "Transient Suppressor Dynamic Parameters." TI Technical Journal, vol. 6, No. 4, pp.63-70, July-August 1989).

Lightning Surge

Wave Shape Notation

Most lightning tests, used for equipment verification, specify a unidirectional sawtooth waveform which has an exponential rise and an exponential decay. Wave shapes are classified in terms of peak amplitude (voltage or current), rise time and a decay time to 50% of the maximum amplitude. The notation used for the wave shape is *amplitude, rise time/decay time*. A 50 A, 5/310 μ s wave shape would have a peak current value of 50 A, a rise time of 5 μ s and a decay time of 310 μ s. The TISP[®] surge current graph comprehends the wave shapes of commonly used surges.

Generators

There are three categories of surge generator types, single wave shape, combination wave shape and circuit defined. Single wave shape generators have essentially the same wave shape for the open circuit voltage and short circuit current (e.g. 10/1000 μ s open circuit voltage and short circuit current). Combination generators have two wave shapes, one for the open circuit voltage and the other for the short circuit current (e.g. 1.2/50 μ s open circuit voltage and 8/20 μ s short circuit current). Circuit specified generators usually equate to a combination generator, although typically only the open circuit voltage waveshape is referenced (e.g. a 10/700 μ s open circuit voltage generator typically produces a 5/310 μ s short circuit current). If the combination or circuit defined generators operate into a finite resistance, the wave shape produced is intermediate between the open circuit and short circuit values.

Current Rating

When the TISP[®] device switches into the on-state it has a very low impedance. As a result, although the surge wave shape may be defined in terms of open circuit voltage, it is the current wave shape that must be used to assess the required TISP[®] surge capability. As an example, the ITU-T K.21 1.5 kV, 10/700 μ s open circuit voltage surge is changed to a 38 A, 5/310 μ s current waveshape when driving into a short circuit. Thus, the TISP[®] surge current capability, when directly connected to the generator, will be found for the ITU-T K.21 waveform at 310 μ s on the surge graph and not 700 μ s. Some common short circuit equivalents are tabulated below:

Standard	Open Circuit Voltage	Short Circuit Current
ITU-T K.21	1.5 kV, 10/700 μ s	37.5 A, 5/310 μ s
ITU-T K.20	1 kV, 10/700 μ s	25 A, 5/310 μ s
IEC 61000-4-5, combination wave generator	1.0 kV, 1.2/50 μ s	500 A, 8/20 μ s
Telcordia GR-1089-CORE	1.0 kV, 10/1000 μ s	100 A, 10/1000 μ s
Telcordia GR-1089-CORE	2.5 kV, 2/10 μ s	500 A, 2/10 μ s
FCC Part 68, Type A	1.5 kV, <10/>160 μ s	200 A, <10/>160 μ s
FCC Part 68, Type A	800 V, <10/>560 μ s	100 A, <10/>160 μ s
FCC Part 68, Type B	1.5 kV, 9/720 μ s	37.5 A, 5/320 μ s

Any series resistance in the protected equipment will reduce the peak circuit current to less than the generators' short circuit value. A 1 kV open circuit voltage, 100 A short circuit current generator has an effective output impedance of 10 Ω (1000/100). If the equipment has a series resistance of 25 Ω then the surge current requirement of the TISP[®] device becomes 29 A (1000/35) and not 100 A.

APPLICATIONS INFORMATION

Protection Voltage

The protection voltage, ($V_{(BO)}$), increases under lightning surge conditions due to thyristor regeneration. This increase is dependent on the rate of current rise, di/dt , when the TISP[®] device is clamping the voltage in its breakdown region. The $V_{(BO)}$ value under surge conditions can be estimated by multiplying the 50 Hz rate $V_{(BO)}$ (250 V/ms) value by the normalized increase at the surge's di/dt (Figure 8.). An estimate of the di/dt can be made from the surge generator voltage rate of rise, dv/dt , and the circuit resistance.

As an example, the ITU-T K.21 1.5 kV, 10/700 μ s surge has an average dv/dt of 150 V/ μ s, but, as the rise is exponential, the initial dv/dt is higher, being in the region of 450 V/ μ s. The instantaneous generator output resistance is 25 Ω . If the equipment has an additional series resistance of 20 Ω , the total series resistance becomes 45 Ω . The maximum di/dt then can be estimated as $450/45 = 10$ A/ μ s. In practice, the measured di/dt and protection voltage increase will be lower due to inductive effects and the finite slope resistance of the TISP[®] device breakdown region.

Capacitance

Off-state Capacitance

The off-state capacitance of a TISP[®] device is sensitive to junction temperature, T_J , and the bias voltage, comprising of the d.c. voltage, V_D , and the a.c. voltage, V_d . All the capacitance values in this data sheet are measured with an a.c. voltage of 100 mV. The typical 25 $^{\circ}$ C variation of capacitance value with a.c. bias is shown in Figure 21. When $V_D \gg V_d$, the capacitance value is independent on the value of V_d . The capacitance is essentially constant over the range of normal telecommunication frequencies.

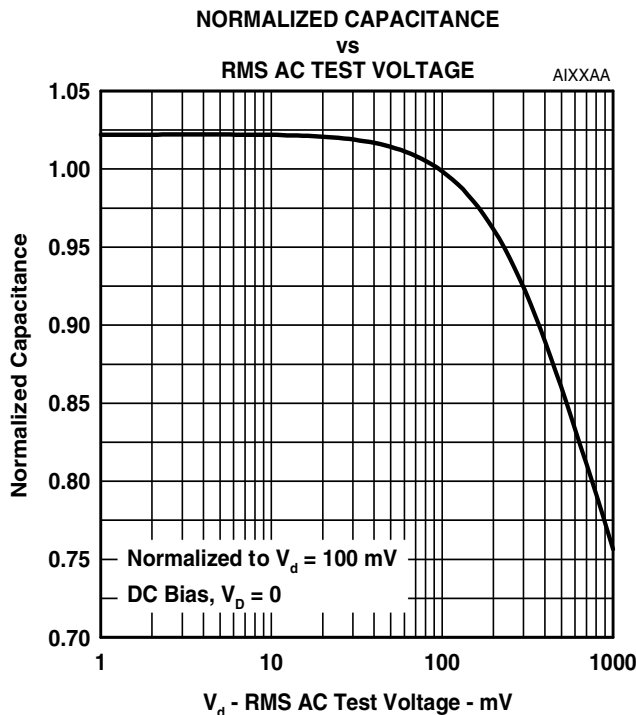

Figure 21.

APPLICATIONS INFORMATION

Longitudinal Balance

Figure 22 shows a three terminal TISP[®] device with its equivalent “delta” capacitance. Each capacitance, C_{TG} , C_{RG} and C_{TR} , is the true terminal pair capacitance measured with a three terminal or guarded capacitance bridge. If wire R is biased at a larger potential than wire T, then $C_{TG} > C_{RG}$. Capacitance C_{TG} is equivalent to a capacitance of C_{RG} in parallel with the capacitive difference of $(C_{TG} - C_{RG})$. The line capacitive unbalance is due to $(C_{TG} - C_{RG})$ and the capacitance shunting the line is $C_{TR} + C_{RG}/2$.

All capacitance measurements in this data sheet are three terminal guarded to allow the designer to accurately assess capacitive unbalance effects. Simple two terminal capacitance meters (unguarded third terminal) give false readings as the shunt capacitance via the third terminal is included.

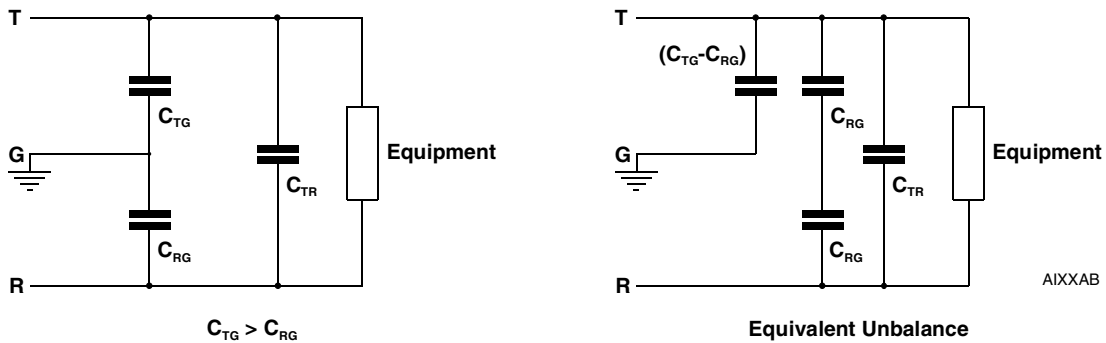
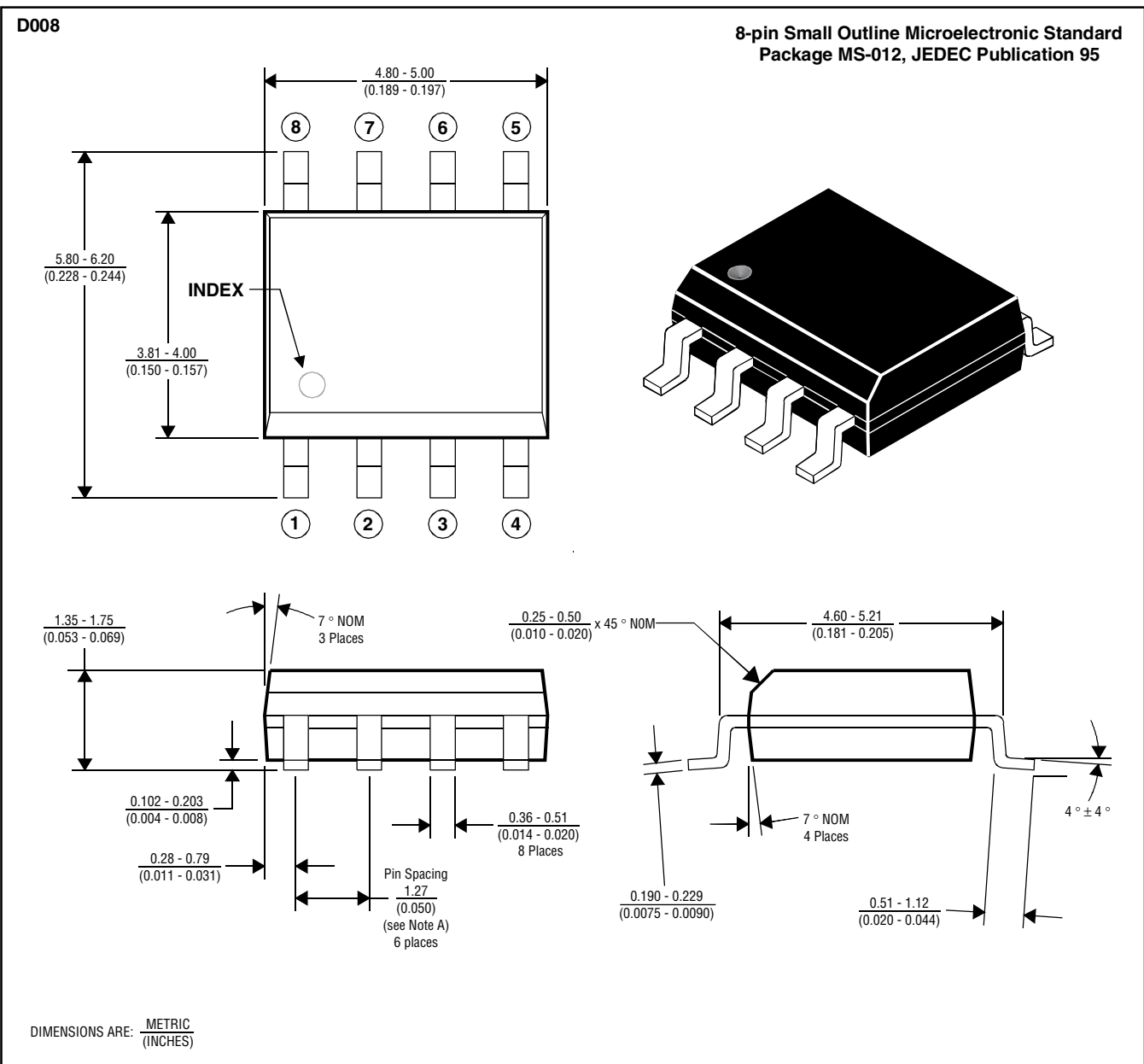

Figure 22.

MECHANICAL DATA

D008 Plastic Small-outline Package

This small-outline package consists of a circuit mounted on a lead frame and encapsulated within a plastic compound. The compound will withstand soldering temperature with no deformation, and circuit performance characteristics will remain stable when operated in high humidity conditions. Leads require no additional cleaning or processing when used in soldered assembly.



- NOTES: A. Leads are within 0.25 (0.010) radius of true position at maximum material condition.
 B. Body dimensions do not include mold flash or protrusion.
 C. Mold flash or protrusion shall not exceed 0.15 (0.006).
 D. Lead tips to be planar within ± 0.051 (0.002).

MDXXAAC

MECHANICAL DATA

D008 Tape Dimensions

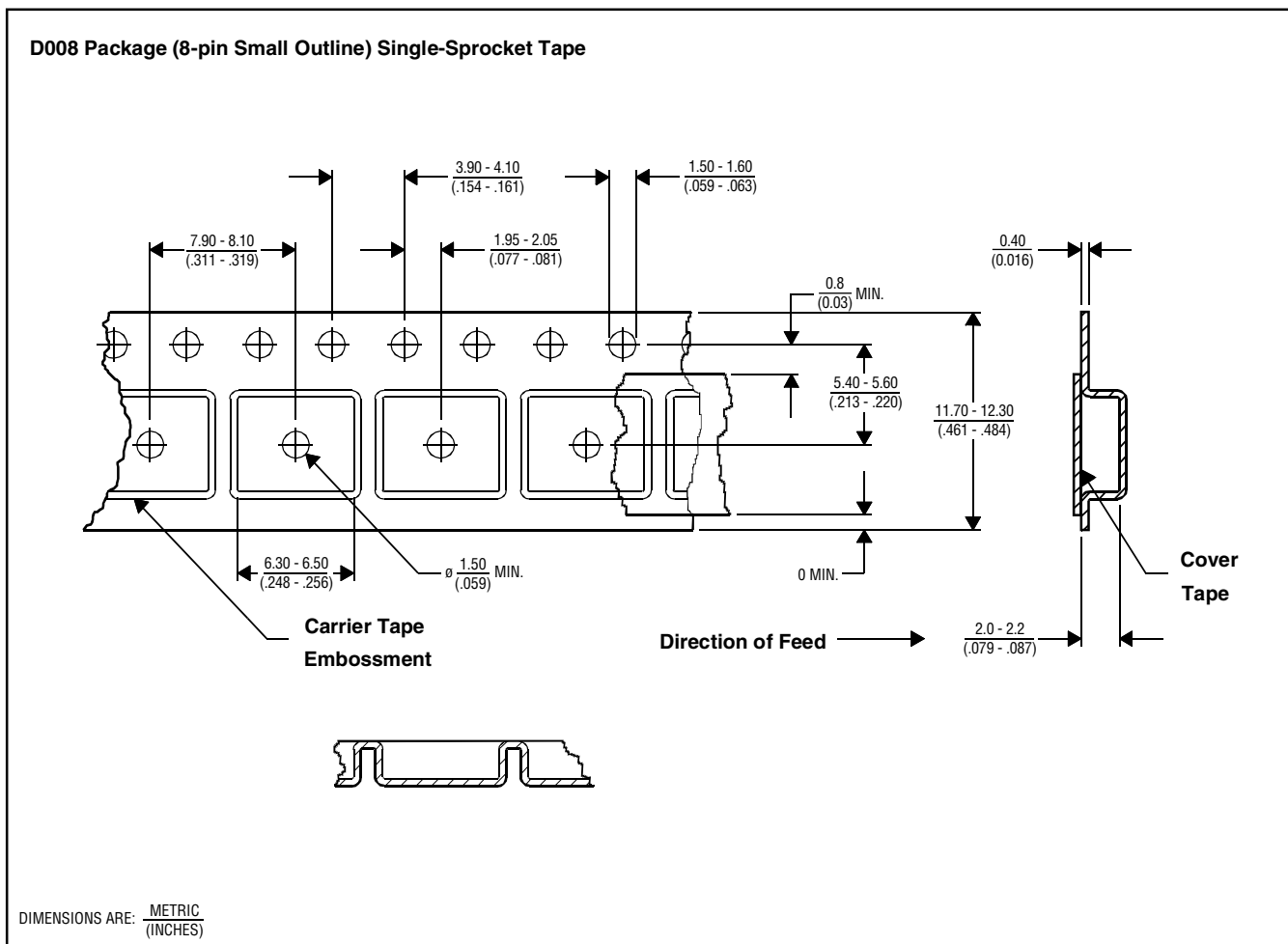

NOTES: A. Taped devices are supplied on a reel of the following dimensions:-

MDXXATB

Reel diameter: $\frac{330 + 0.0/-4.0}{(12.992 + 0.0/-1.57)}$

Reel hub diameter: $\frac{100 \pm 2.0}{(3.937 \pm .079)}$

Reel axial hole: $\frac{13.0 \pm 0.2}{(.512 \pm .008)}$

B. 2500 devices are on a reel.

MECHANICAL DATA

P008 Plastic Dual-in-line Package

This dual-in-line package consists of a circuit mounted on a lead frame and encapsulated within a plastic compound. The compound will withstand soldering temperature with no deformation, and circuit performance characteristics will remain stable when operated in high humidity conditions. The package is intended for insertion in mounting-hole rows on 7.62 (0.300) centers. Once the leads are compressed and inserted, sufficient tension is provided to secure the package in the board during soldering. Leads require no additional cleaning or processing when used in soldered assembly.

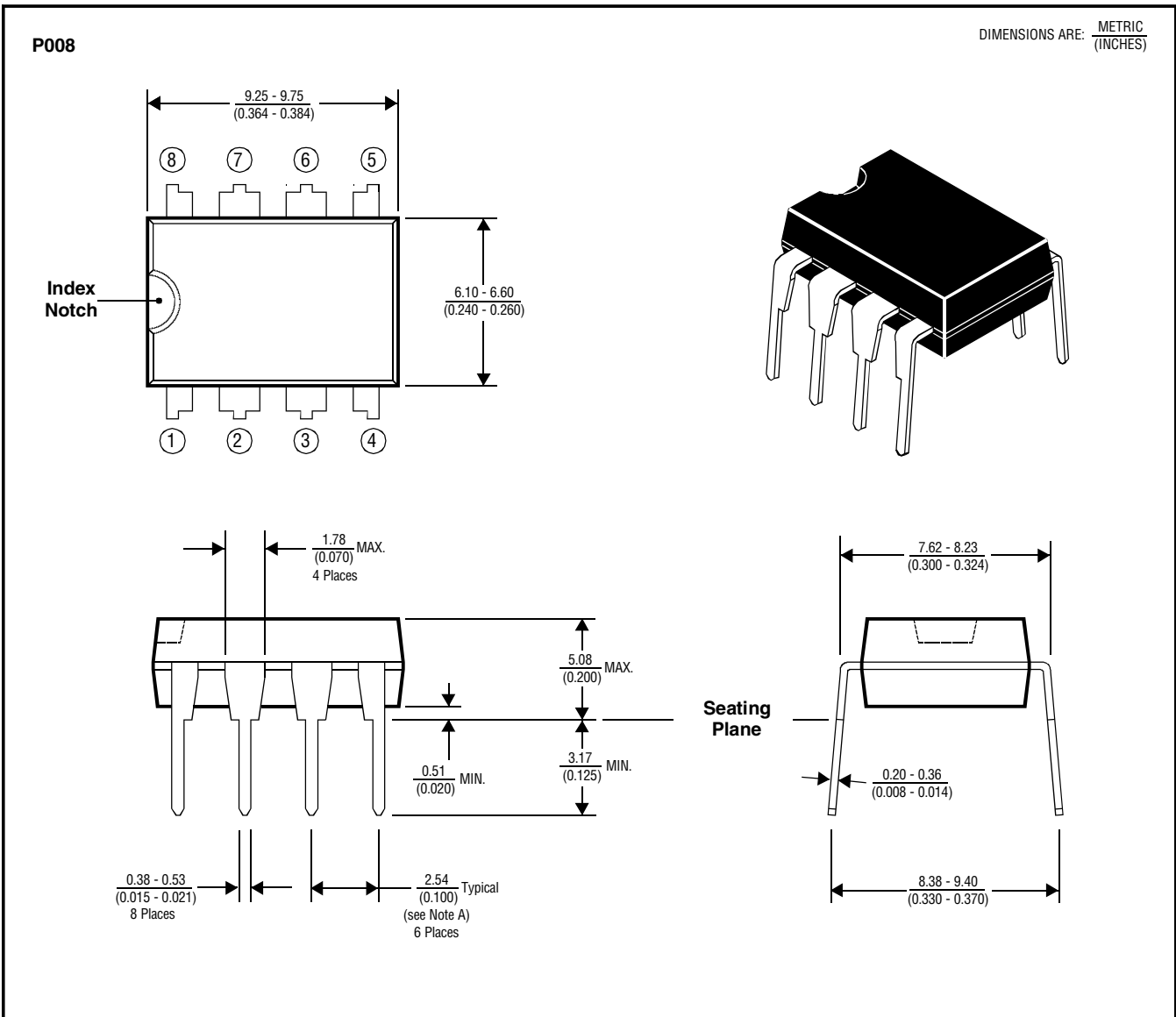

- NOTES: A. Each pin centerline is located within 0.25 (0.010) of its true longitudinal position.
 B. Dimensions fall within JEDEC MS001 - R-PDIP-T, 0.300" Dual-In-Line Plastic Family.

MDXXCF

MECHANICAL DATA

SL003 3-pin Plastic Single-in-line Package

This single-in-line package consists of a circuit mounted on a lead frame and encapsulated within a plastic compound. The compound will withstand soldering temperature with no deformation, and circuit performance characteristics will remain stable when operated in high humidity conditions. Leads require no additional cleaning or processing when used in soldered assembly.

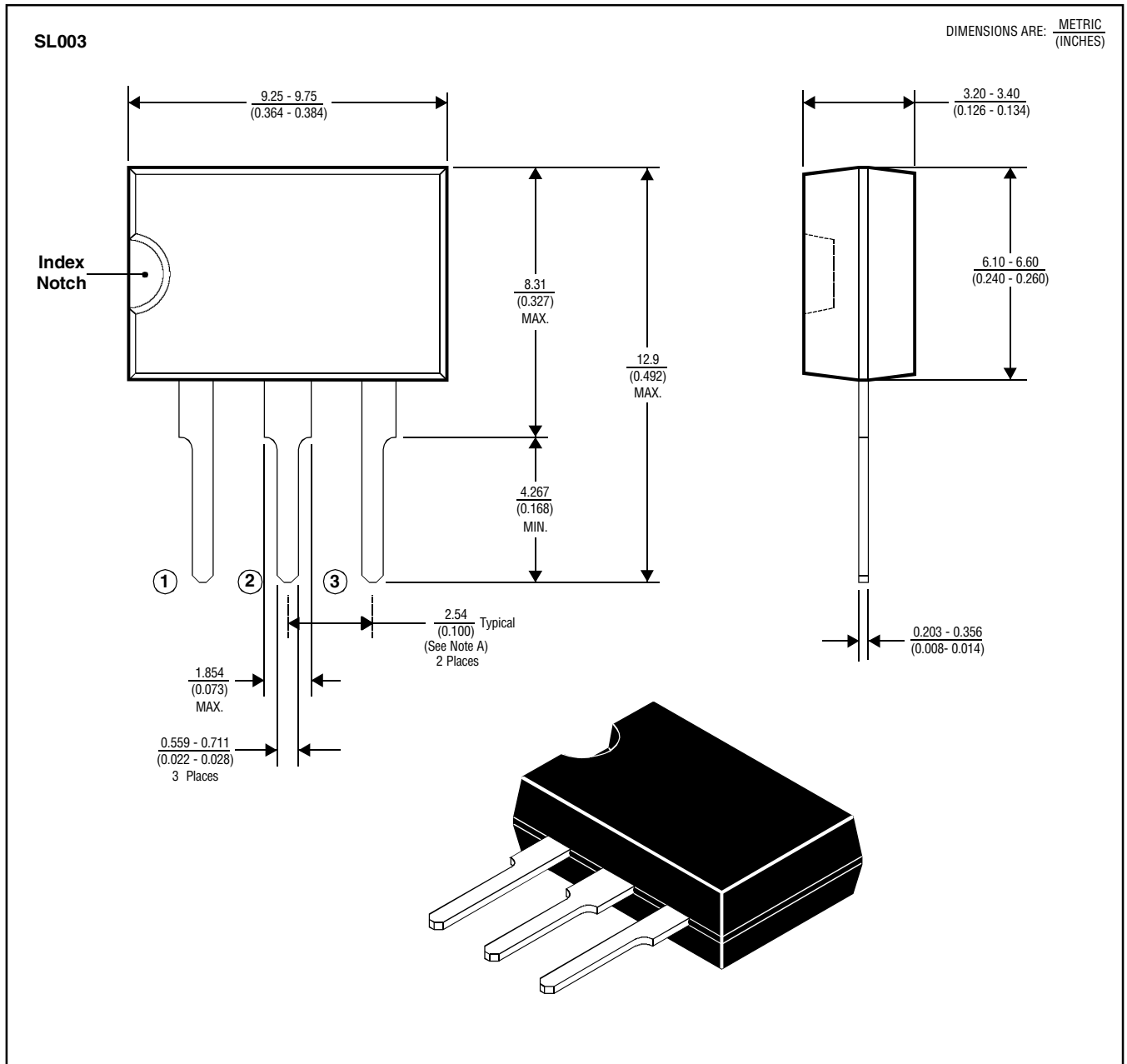



NOTES: A. Each pin centerline is located within 0.25 (0.010) of its true longitudinal position.
 B. Body molding flash of up to 0.15 (0.006) may occur in the package lead plane.





MDXXCE

Looking for pricing, stock, or lifecycle information?

Click below to explore more details on WIN SOURCE:

-  [View TISP1072F3SL on WIN SOURCE](#)
-  [Bourns Inc. Information](#)

Optimize Your Supply Chain with WIN SOURCE Solutions

-  Global Sourcing Solution
-  Obsolete Management
-  Cost Control Management
-  Shortage Management
-  Alternative Solution
-  Excess Inventory Management