



## LOW-NOISE ADSL DUAL DIFFERENTIAL RECEIVER

### FEATURES

- ADSL Differential Receiver
- Low  $1.6 \text{ nV}/\sqrt{\text{Hz}}$  Voltage Noise
- High Speed
  - 100 MHz Bandwidth [–3 dB,  $G = 2 (-1)$ ]
  - 100 V/ $\mu\text{s}$  Slew Rate
- 90 mA Output Drive (Typ)
- Very Low Distortion
  - THD = –72 dBc ( $f = 1 \text{ MHz}$ ,  $R_L = 150 \Omega$ )
  - THD = –90 dBc ( $f = 1 \text{ MHz}$ ,  $R_L = 1 \text{ k}\Omega$ )
- 5 V,  $\pm 5 \text{ V}$  to  $\pm 15 \text{ V}$  Typical Operation
- Available in Standard SOIC or MSOP PowerPAD™ Package

SOIC (D) AND MSOP PowerPAD (DGN) PACKAGE (TOP VIEW)

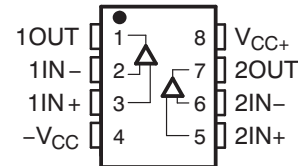

Cross Section View of DGN Package

### DESCRIPTION

The THS6062 is a high-speed differential receiver designed for ADSL data communication systems. Its very low  $1.6 \text{ nV}/\sqrt{\text{Hz}}$  voltage noise provides the high signal-to-noise ratios necessary for the long transmission lengths of ADSL systems over copper telephone lines. In addition, this receiver operates with a very low distortion of –90 dBc ( $f = 1 \text{ MHz}$ ,  $R_L = 1 \text{ k}\Omega$ ), exceeding the distortion requirements of ADSL CODECs. The THS6062 is a voltage feedback amplifier offering a high 100-MHz bandwidth and 100-V/ $\mu\text{s}$  slew rate and is stable at gains of 2(–1) or greater. It operates over a wide range of power supply voltages including 5 V and  $\pm 5 \text{ V}$  to  $\pm 15 \text{ V}$ . This device is available in standard SOIC or MSOP PowerPAD package. The small, surface-mount, thermally-enhanced MSOP PowerPAD package is fully compatible with automated surface-mount assembly procedures.

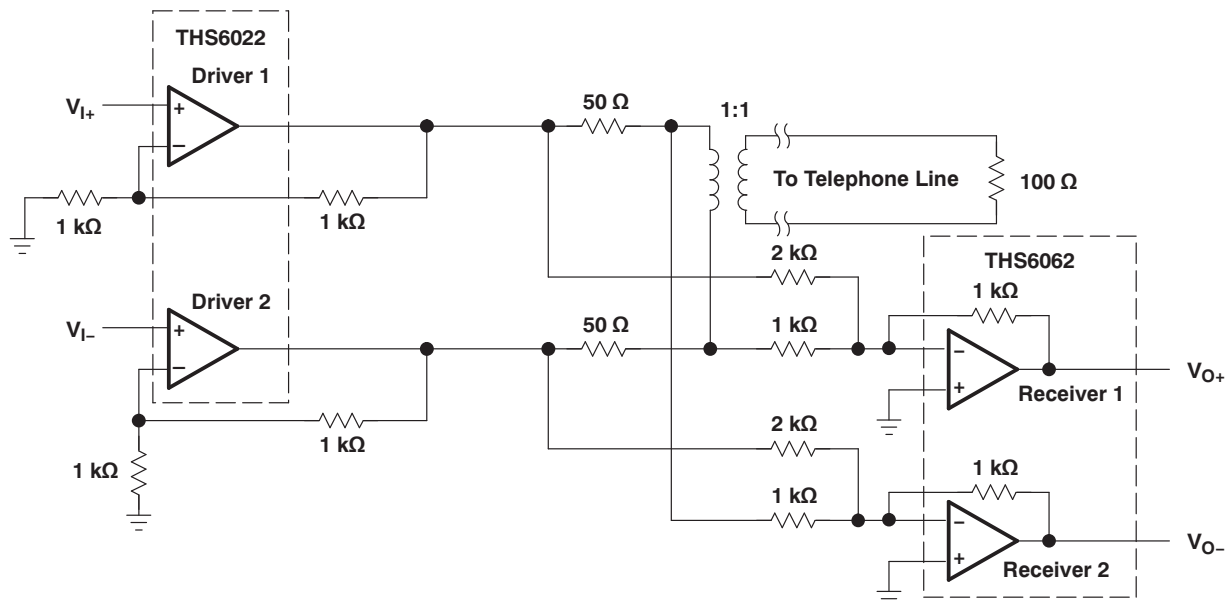

Figure 1. Typical Client-Side ADSL Application



Please be aware that an important notice concerning availability, standard warranty, and use in critical applications of Texas Instruments semiconductor products and disclaimers thereto appears at the end of this data sheet.

PowerPAD is a trademark of Texas Instruments.



These devices have limited built-in ESD protection. The leads should be shorted together or the device placed in conductive foam during storage or handling to prevent electrostatic damage to the MOS gates.

**HIGH-SPEED XDSDL LINE DRIVER/RECEIVER FAMILY**

DEVICE	DRIVER	RECEIVER	5 V	±5 V	±15 V	BW (MHz)	SR (V/μs)	THD f = 1 MHz (dB)	I <sub>o</sub> (mA)	V <sub>n</sub> (nV/√Hz)
THS6002	•	•		•	•	140	1000	–62	500	1.7
THS6012	•			•	•	140	1300	–65	500	1.7
THS6022	•			•	•	210	1900	–66	250	1.7
THS6062		•	•	•	•	100	100	–72	90	1.6
THS7002		•		•	•	70	100	–84	25	2.0

**AVAILABLE OPTIONS**

T <sub>A</sub>	PACKAGED DEVICES			
	PLASTIC SMALL OUTLINE <sup>(1)</sup> (D)	PowerPAD PLASTIC MSOP <sup>(1)</sup> (DGN)	MSOP SYMBOL	EVALUATION MODULE
0°C to 70°C	THS6062CD	THS6062CDGN	TIABE	THS6062EVM
–40°C to 85°C	THS6062ID	THS6062IDGN	TIABH	—

(1) The D and DGN packages are available taped and reeled. Add an R suffix to the device type (i.e., THS6062CDGNR).

**FUNCTIONAL BLOCK DIAGRAM**

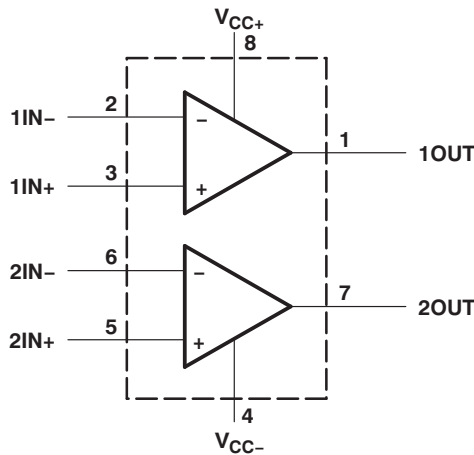

PRODUCT PREVIEW

## ABSOLUTE MAXIMUM RATINGS

over operating free-air temperature range (unless otherwise noted) <sup>(1)</sup>

		VALUE	UNIT
$V_{CC+}$ to $V_{CC-}$	Supply voltage	33	V
$V_I$	Input voltage	$\pm V_{CC}$	
$I_O$	Output current	150	mA
$V_{IO}$	Differential input voltage	$\pm 4$	V
Continuous total power dissipation		See Dissipation Rating Table	
$T_A$	Operating free-air temperature	C-suffix	0C to 70
		I-suffix	-40 to 85
$T_J$	Maximum junction temperature	150	°C
$T_{stg}$	Storage temperature	-65 to 150	°C
Lead temperature 1,6 mm (1/16 inch) from case for 10 seconds		300	°C

- (1) Stresses beyond those listed under *absolute maximum ratings* may cause permanent damage to the device. These are stress ratings only and functional operation of the device at these or any other conditions beyond those indicated under *recommended operating conditions* is not implied. Exposure to absolute-maximum-rated conditions for extended periods may affect device reliability.

## DISSIPATION RATINGS

PACKAGE	$\theta_{JA}$ (°C/W)	$\theta_{JC}$ (°C/W)	$T_A = 25^\circ\text{C}$ POWER RATING
D	167 <sup>(1)</sup>	38.3	740 mW
DGN <sup>(2)</sup>	58.4	4.7	2.14 W

- (1) This data was taken using the JEDEC standard Low-K test PCB. For the JEDEC Proposed High-K test PCB, the  $\theta_{JA}$  is 95°C/W with a power rating at  $T_A = 25^\circ\text{C}$  of 1.32 W.
- (2) This data was taken using 2 oz. trace and copper pad that is soldered directly to a 3 in. × 3 in. PC. For further information, refer to Application Information section of this data sheet.

## RECOMMENDED OPERATING CONDITIONS

		MIN	NOM	MAX	UNIT
$V_{CC+}$ and $V_{CC-}$	Supply voltage	Dual supply	$\pm 2.5$	$\pm 16$	V
		Single supply	5	32	
$T_A$	Operating free-air temperature	C-suffix	0	70	°C
		I-suffix	-40	85	

**ELECTRICAL CHARACTERISTICS**At  $T_A = 25^\circ\text{C}$ ,  $V_{CC} = \pm 15\text{ V}$ ,  $R_L = 150\ \Omega$  (unless otherwise noted)

PARAMETER		TEST CONDITIONS <sup>(1)</sup>		MIN	TYP	MAX	UNIT
$V_{CC}$	Supply voltage operating range	Dual supply		$\pm 2.25$		$\pm 16.5$	V
		Single supply		4.5		33	
$I_{CC}$	Supply current (per amplifier)	$V_{CC} = \pm 15\text{ V}$	$T_A = 25^\circ\text{C}$	8.5		10	mA
			$T_A = \text{full range}$			11	
		$V_{CC} = \pm 5\text{ V}$	$T_A = 25^\circ\text{C}$	7.5		9	mA
			$T_A = \text{full range}$			10.5	
		$V_{CC} = \pm 2.5\text{ V}$	$T_A = 25^\circ\text{C}$	7.3		9	mA
			$T_A = \text{full range}$			10.5	
$V_O$	Output voltage swing	$V_{CC} = \pm 15\text{ V}$	$R_L = 1\ \Omega$	$\pm 13$		$\pm 13.6$	V
				$\pm 3.4$		$\pm 3.8$	
				$\pm 1$		$\pm 1.3$	
		$V_{CC} = \pm 15\text{ V}$	$R_L = 250\ \Omega$	$\pm 12$		$\pm 12.9$	
				$\pm 3$		$\pm 3.5$	
				$\pm 0.9$		$\pm 1.2$	
$I_O$	Output current <sup>(2)</sup>	$V_{CC} = \pm 15\text{ V}$	$R_L = 20\ \Omega$	60		90	mA
				50		70	
				40		55	
$I_{SC}$	Short-circuit current <sup>(2)</sup>	$V_{CC} = \pm 15\text{ V}$			150		mA
$V_{IO}$	Input offset voltage	$V_{CC} = \pm 5\text{ V}$ or $V_{CC} = \pm 15\text{ V}$		$T_A = 25^\circ\text{C}$	1.5	6	mV
				$T_A = \text{full range}$			
	Offset drift	$V_{CC} = \pm 5\text{ V}$ or $V_{CC} = \pm 15\text{ V}$		$T_A = \text{full range}$	20		$\mu\text{V}/^\circ\text{C}$
$I_{IB}$	Input bias current	$V_{CC} = \pm 5\text{ V}$ or $V_{CC} = \pm 15\text{ V}$		$T_A = 25^\circ\text{C}$	3	6	$\mu\text{A}$
				$T_A = \text{full range}$			
$I_{OS}$	Input offset current	$V_{CC} = \pm 5\text{ V}$ or $V_{CC} = \pm 15\text{ V}$		$T_A = 25^\circ\text{C}$	30	250	nA
				$T_A = \text{full range}$			
	Offset current drift	$V_{CC} = \pm 5\text{ V}$ or $V_{CC} = \pm 15\text{ V}$		$T_A = \text{full range}$	0.3		$\text{nA}/^\circ\text{C}$
CMRR	Common mode rejection ratio	$V_{CC} = \pm 15\text{ V}$ , $V_{ICR} = \pm 12\text{ V}$		$T_A = 25^\circ\text{C}$	85	95	dB
				$T_A = \text{full range}$	80		
		$V_{CC} = \pm 5\text{ V}$ , $V_{ICR} = \pm 2.5\text{ V}$		$T_A = 25^\circ\text{C}$	90	100	
				$T_A = \text{full range}$	85		
PSRR	Power supply rejection ratio	$V_{CC} = \pm 5\text{ V}$ or $\pm 15\text{ V}$		$T_A = 25^\circ\text{C}$	85	95	dB
				$T_A = \text{full range}$	80		
$V_{ICR}$	Common-mode input voltage range	$V_{CC} = \pm 15\text{ V}$		$\pm 13.5$		$\pm 14.3$	V
		$V_{CC} = \pm 5\text{ V}$		$\pm 3.8$		$\pm 4.3$	
		$V_{CC} = \pm 2.5\text{ V}$		$\pm 1.4$		$\pm 1.8$	
$R_I$	Input resistance				2		$\text{M}\Omega$
$C_I$	Input capacitance				1.5		pF
$R_O$	Output resistance	Open loop			13		$\Omega$
	Open loop gain	$V_{CC} = \pm 5\text{ V}$ , $V_O = \pm 10\text{ V}$ , $R_L = 1\ \text{k}\Omega$		$T_A = 25^\circ\text{C}$	40	70	V/mV
				$T_A = \text{full range}$	35		
		$V_{CC} = \pm 5\text{ V}$ , $V_O = \pm 2.5\text{ V}$ , $R_L = 1\ \text{k}\Omega$		$T_A = 25^\circ\text{C}$	35	50	V/mV
				$T_A = \text{full range}$	30		

(1) Full range =  $0^\circ\text{C}$  to  $70^\circ\text{C}$  for the THS6062C and  $-40^\circ\text{C}$  to  $85^\circ\text{C}$  for the THS6062I.

(2) Observe power dissipation ratings to keep the junction temperature below absolute maximum ratings when the output is heavily loaded or shorted. See the absolute maximum ratings section for more information.

**OPERATING CHARACTERISTICS**

At  $T_A = 25^\circ\text{C}$ ,  $V_{CC} = \pm 15\text{ V}$ ,  $R_L = 150\ \Omega$  (unless otherwise noted)

PARAMETER		TEST CONDITIONS <sup>(1)</sup>		MIN	TYP	MAX	UNIT
SR	Slew rate <sup>(2)</sup>	$V_{CC} = \pm 15\text{ V}$	GAIN = -1		100		V/ $\mu\text{s}$
		$V_{CC} = \pm 5\text{ V}$			80		
		$V_{CC} = \pm 2.5\text{ V}$			70		
$t_s$	Settling time to 0.1%	$V_{CC} = \pm 15\text{ V}$ , 5-V step	GAIN = -1		60		ns
		$V_{CC} = \pm 5\text{ V}$ , 2.5-V step			45		
		$V_{CC} = \pm 2.5\text{ V}$ , 1-V step			35		
	Settling time to 0.01%	$V_{CC} = \pm 15\text{ V}$ , 5-V step	GAIN = -1		90		ns
		$V_{CC} = \pm 5\text{ V}$ , 2.5-V step			80		
		$V_{CC} = \pm 2.5\text{ V}$ , 1-V step			75		
THD	Total harmonic distortion	$V_{CC} = \pm 5\text{ V}$ or $\pm 15\text{ V}$ , $V_{O(pp)} = 2\text{ V}$ , $f = 1\text{ MHz}$ , Gain = 2)	$R_L = 150\ \Omega$		-72		dBc
			$R_L = 1\text{ k}\Omega$		-90		
$V_n$	Input voltage noise	$V_{CC} = \pm 5\text{ V}$ or $\pm 15\text{ V}$ , $f = 10\text{ kHz}$			1.6		nV/ $\sqrt{\text{Hz}}$
$I_n$	Input current noise	$V_{CC} = \pm 5\text{ V}$ or $\pm 15\text{ V}$ , $f = 10\text{ kHz}$			1.2		pV/ $\sqrt{\text{Hz}}$
BW	Dynamic performance small-signal bandwidth (-3 dB)	$V_{CC} = \pm 15\text{ V}$	$V_{O(pp)} = 0.4\text{ V}$ , Gain = 2, -1		100		MHz
		$V_{CC} = \pm 5\text{ V}$			90		
		$V_{CC} = \pm 2.5\text{ V}$			85		
	Bandwidth for 0.1 dB flatness	$V_{CC} = \pm 15\text{ V}$	$V_{O(pp)} = 0.4\text{ V}$ , Gain = 2, -1		50		MHz
		$V_{CC} = \pm 5\text{ V}$			45		
		$V_{CC} = \pm 2.5\text{ V}$			40		
	Full power bandwidth <sup>(3)</sup>		$V_{O(pp)} = 20\text{ V}$ , $V_{CC} = \pm 15\text{ V}$	$R_L = 1\text{ k}\Omega$		1.6	
$V_{O(pp)} = 5\text{ V}$ , $V_{CC} = \pm 5\text{ V}$					5		
Channel-to-channel crosstalk		$V_{CC} = \pm 5\text{ V}$ or $\pm 15\text{ V}$ , $f = 1\text{ MHz}$ , Gain = 2			-61		dBc

(1) Full range =  $0^\circ\text{C}$  to  $70^\circ\text{C}$  for the THS6062C and  $-40^\circ\text{C}$  to  $85^\circ\text{C}$  for the THS6062I.

(2) Slew rate is measured from an output level range of 25% to 75%.

(3) Full power bandwidth = slew rate /  $2\pi V_{(peak)}$

PARAMETER MEASUREMENT INFORMATION

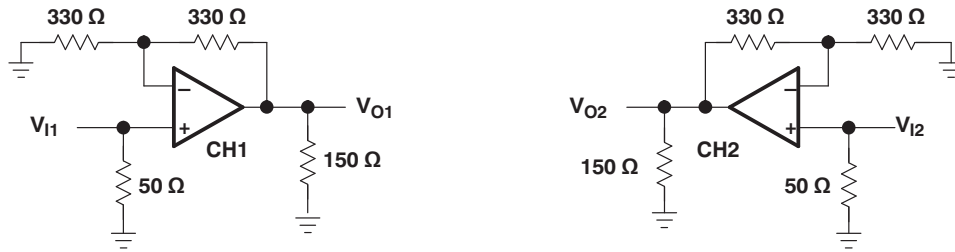

Figure 2. THS6062 Crosstalk Test Circuit

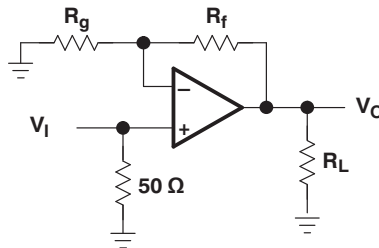

Figure 3. Step Response Test Circuit

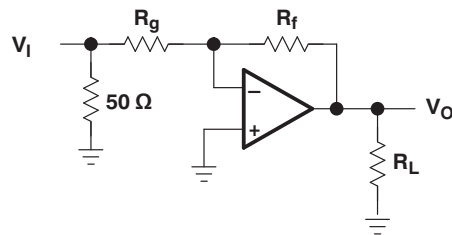

Figure 4. Step Response Test Circuit

PRODUCT PREVIEW

## TYPICAL CHARACTERISTICS

### Table of Graphs

			FIGURE
$V_{IO}$	Input offset voltage	vs Free-air temperature	5
$I_{IB}$	Input bias current	vs Free-air temperature	6
$V_O$	Output voltage	vs Supply voltage	7
	Maximum output voltage swing	vs Free-air temperature	8
$I_O$	Maximum output current	vs Free-air temperature	9
$I_{CC}$	Supply current	vs Free-air temperature	10
$V_{IC}$	Common-mode input voltage	vs Supply voltage	11
$Z_O$	Closed-loop output impedance	vs Frequency	12
	Open-loop gain and Phase Response		13
PSRR	Power-supply rejection ratio	vs Frequency	14
CMRR	Common-mode rejection ratio	vs Frequency	15
	Voltage noise and current noise	vs Frequency	16
	Crosstalk	vs Frequency	17
	Harmonic distortion	vs Frequency	18, 19
	Harmonic distortion	vs Peak-to-peak output voltage	20, 21
SR	Slew rate	vs Free-air temperature	22
	0.1% settling time	vs Output voltage step size	23
	Output amplitude	vs Frequency	24–30
	Small and large frequency response		31–34
	1-V step response		35, 36
	4-V step response		37
	20-V step response		38

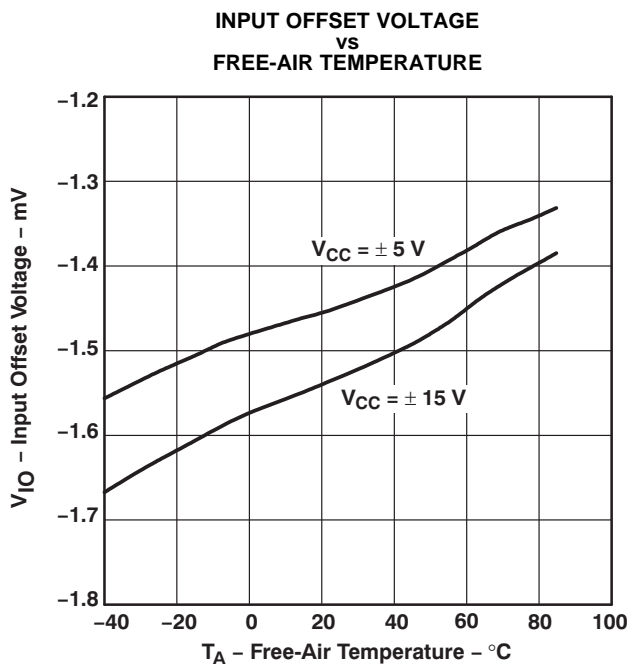

Figure 5.

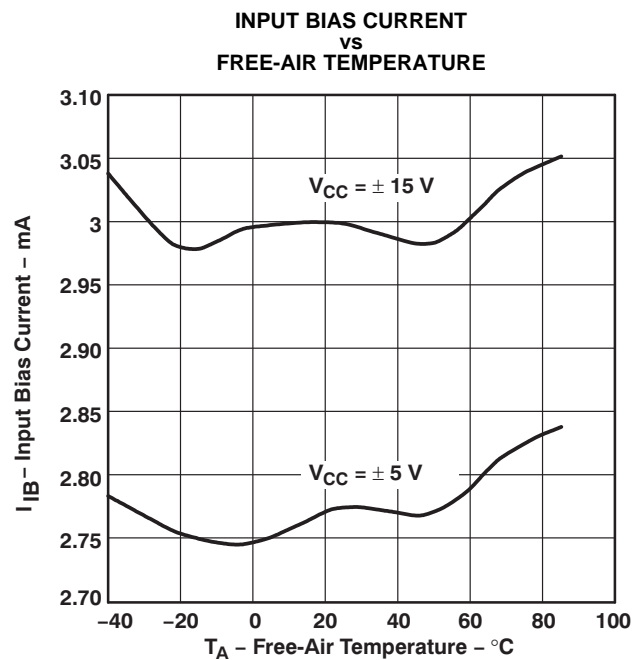

Figure 6.

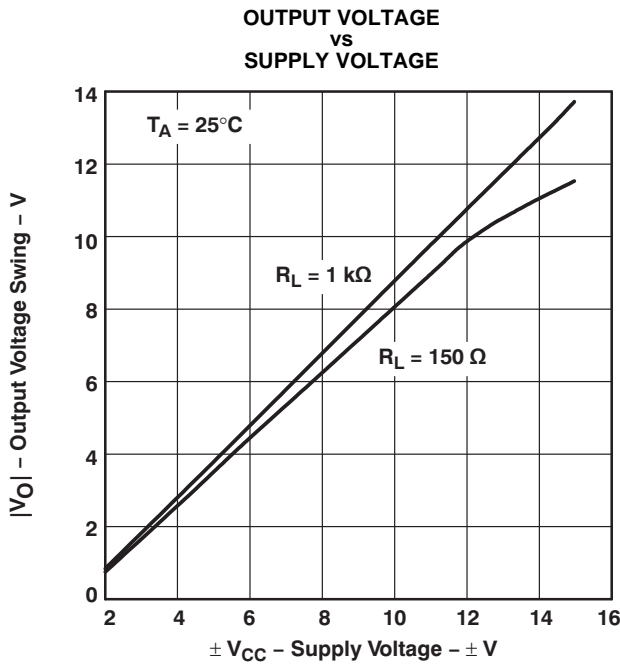

Figure 7.

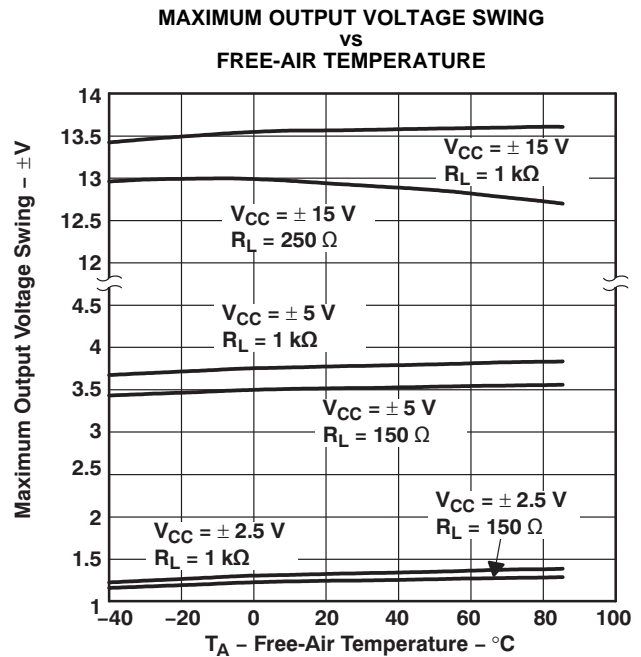

Figure 8.

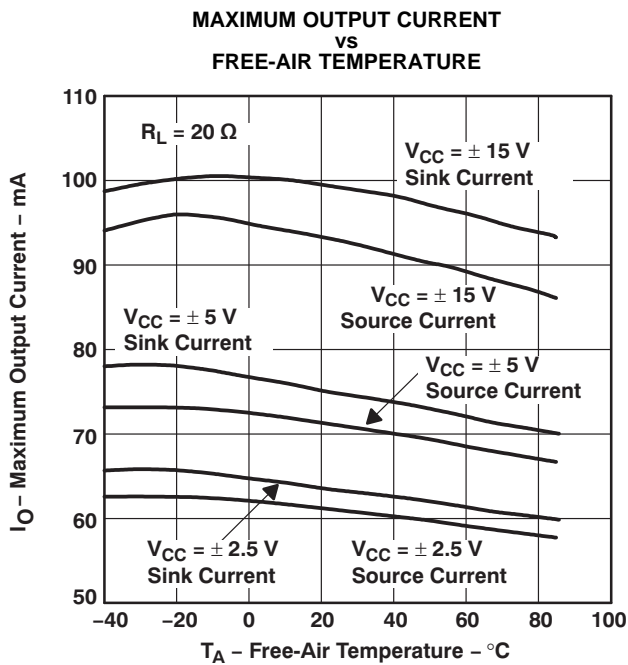

Figure 9.

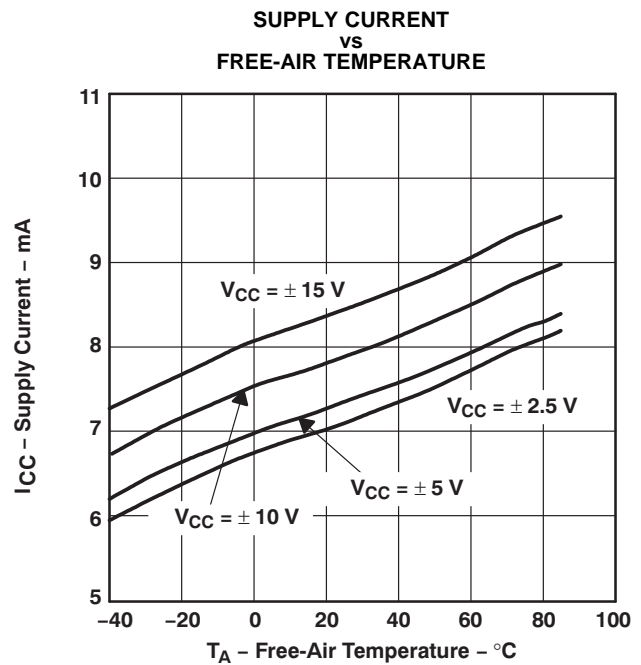

Figure 10.

PRODUCT PREVIEW

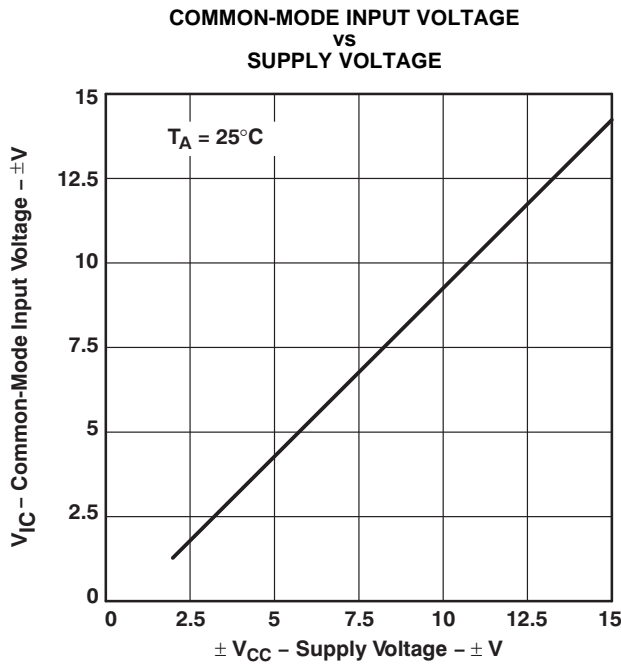

Figure 11.

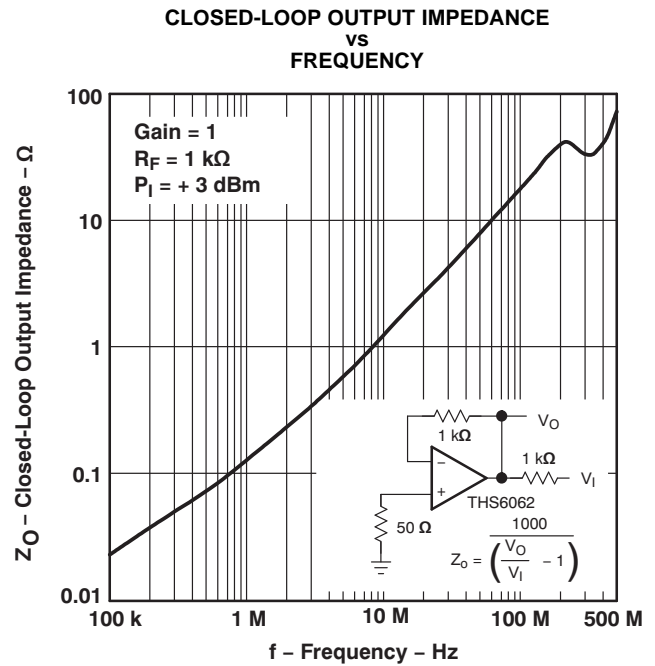

Figure 12.

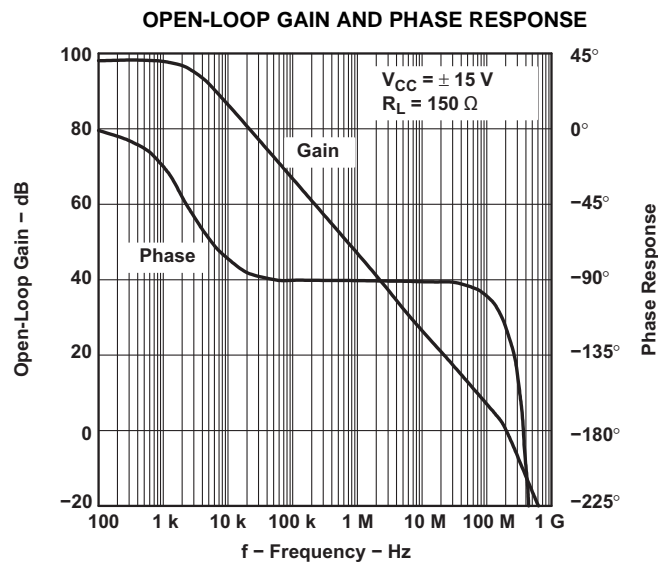

Figure 13.

**PRODUCT PREVIEW**

**POWER-SUPPLY REJECTION RATIO  
VS  
FREQUENCY**

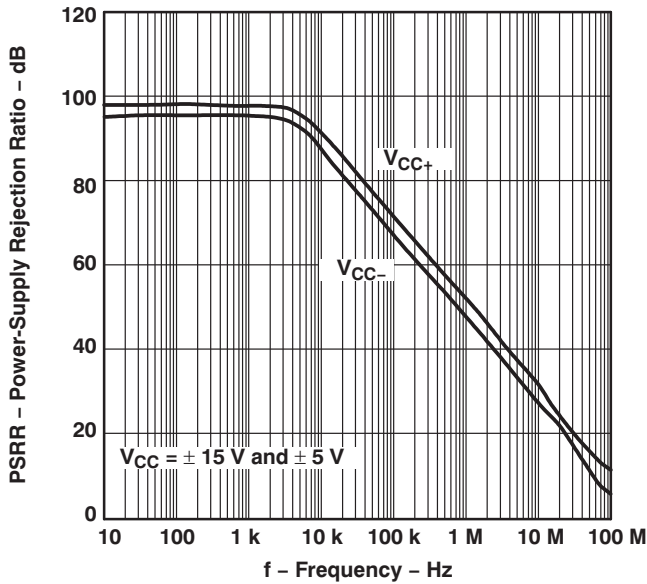

Figure 14.

**COMMON-MODE REJECTION RATIO  
VS  
FREQUENCY**

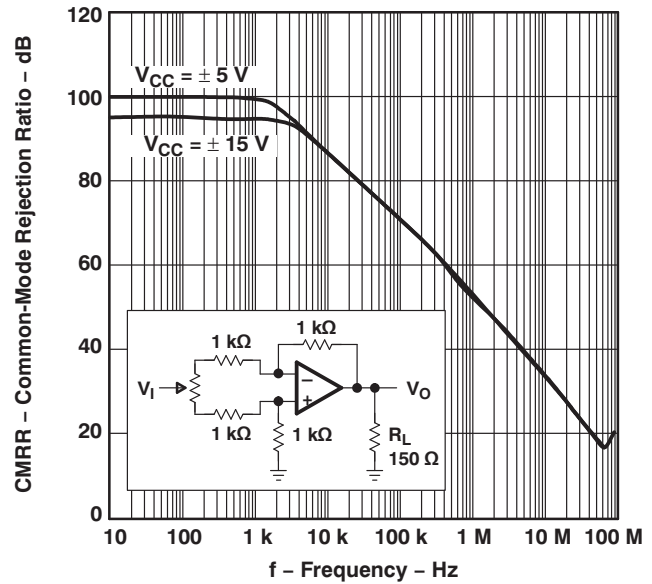

Figure 15.

**VOLTAGE NOISE AND CURRENT NOISE  
VS  
FREQUENCY**

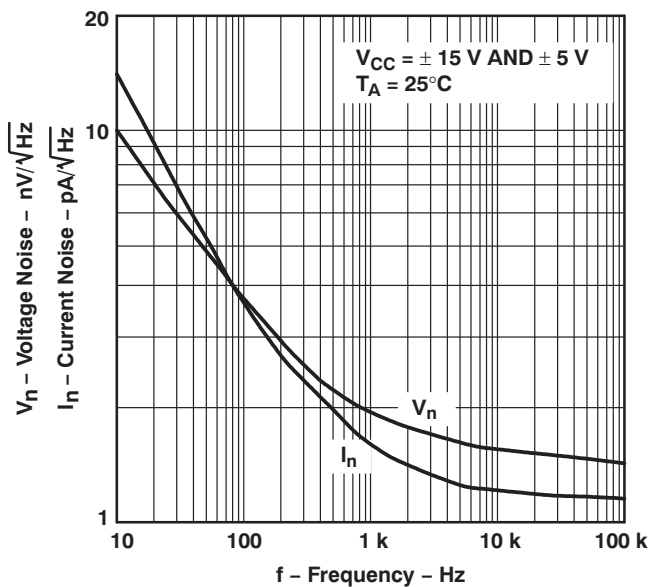

Figure 16.

**CROSTALK  
VS  
FREQUENCY**

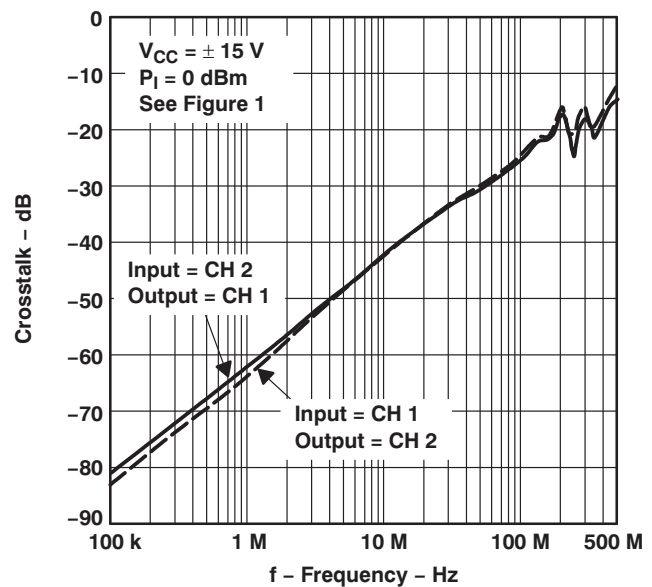

Figure 17.

PRODUCT PREVIEW

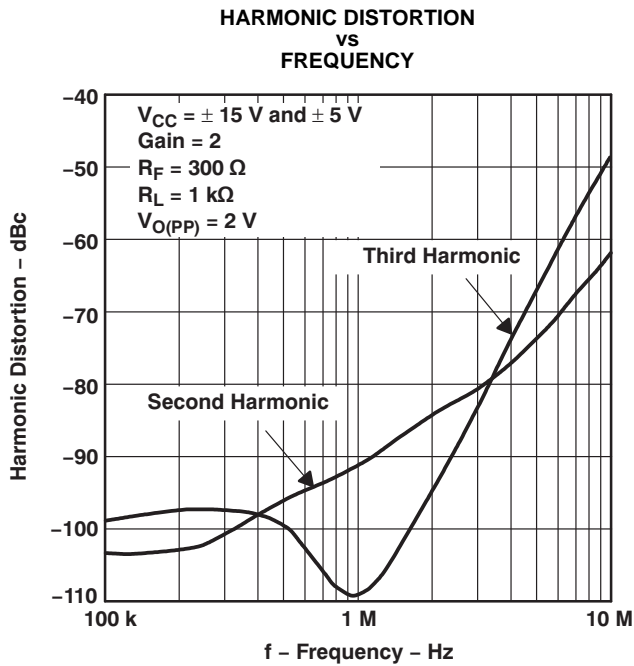

Figure 18.

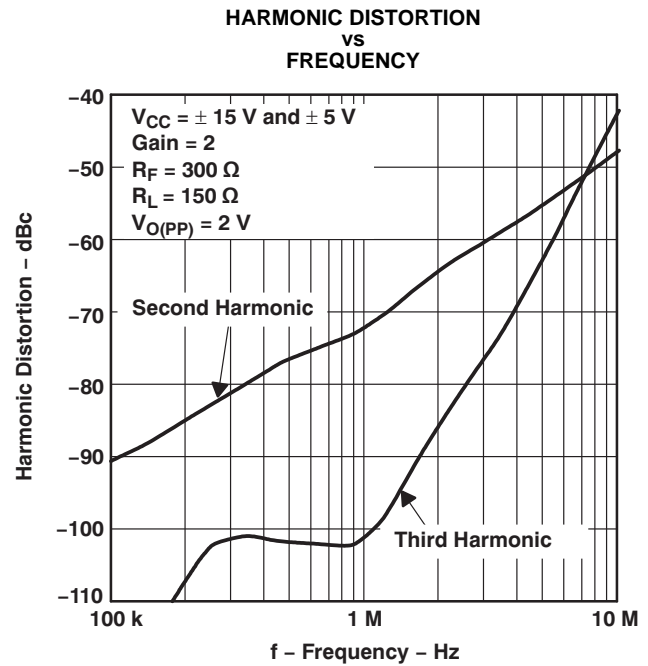

Figure 19.

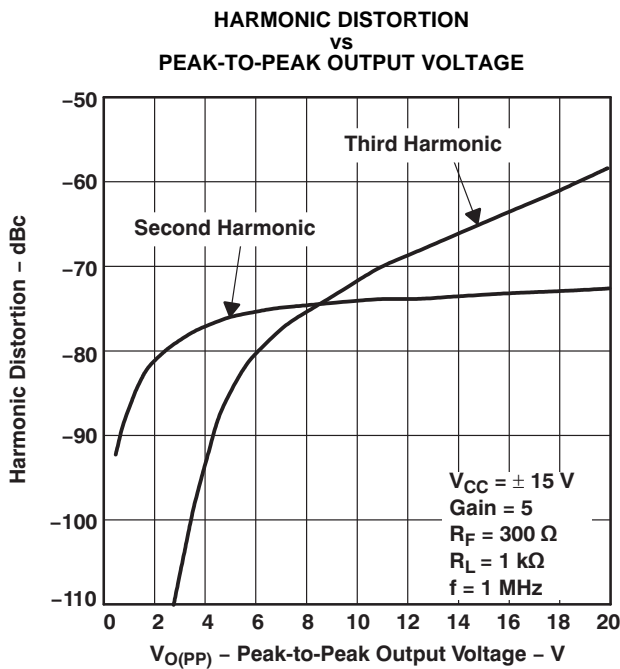

Figure 20.

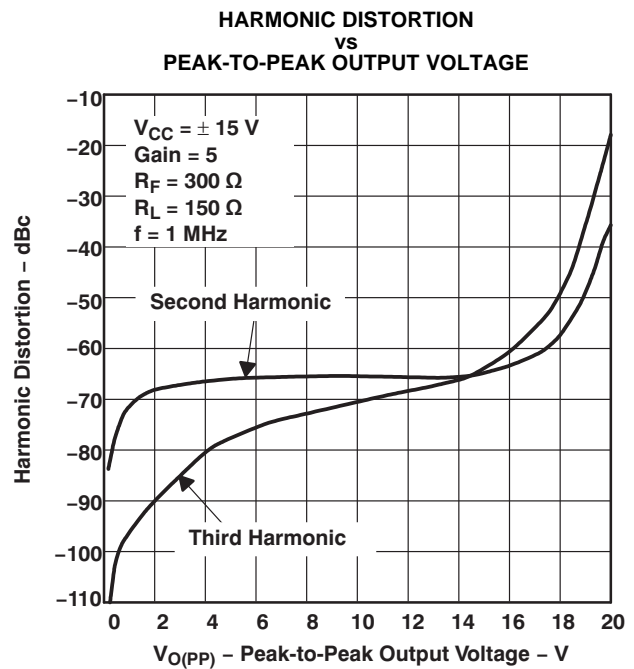

Figure 21.

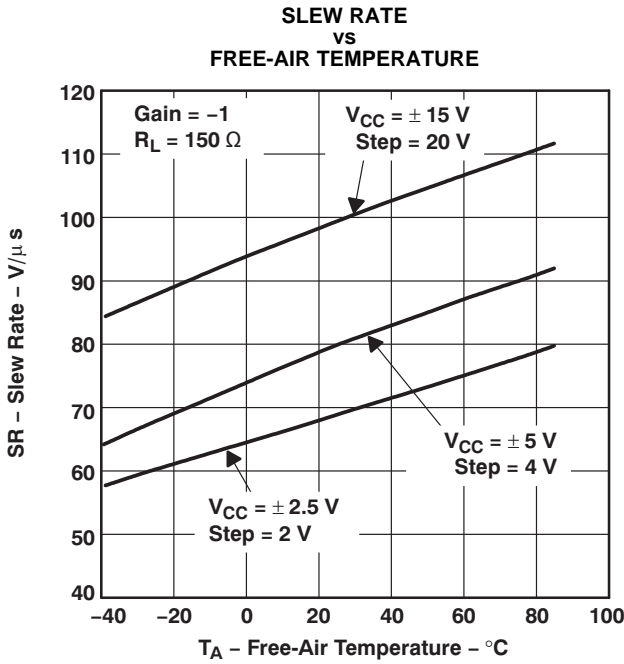

Figure 22.

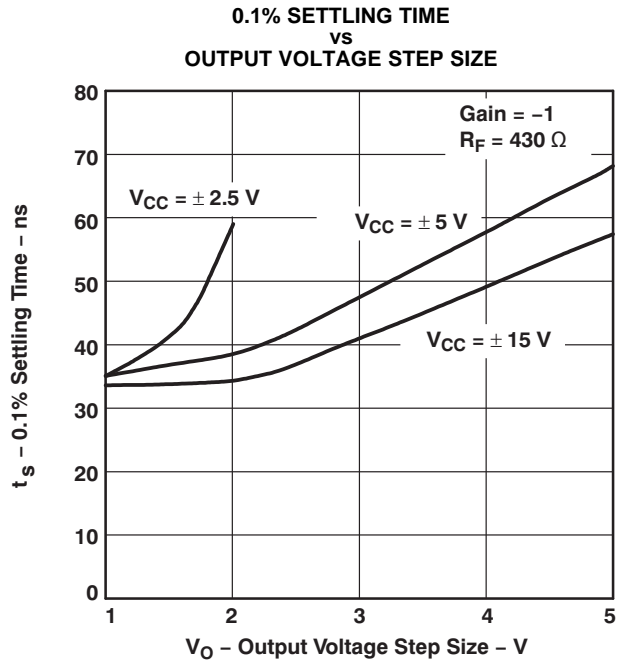

Figure 23.

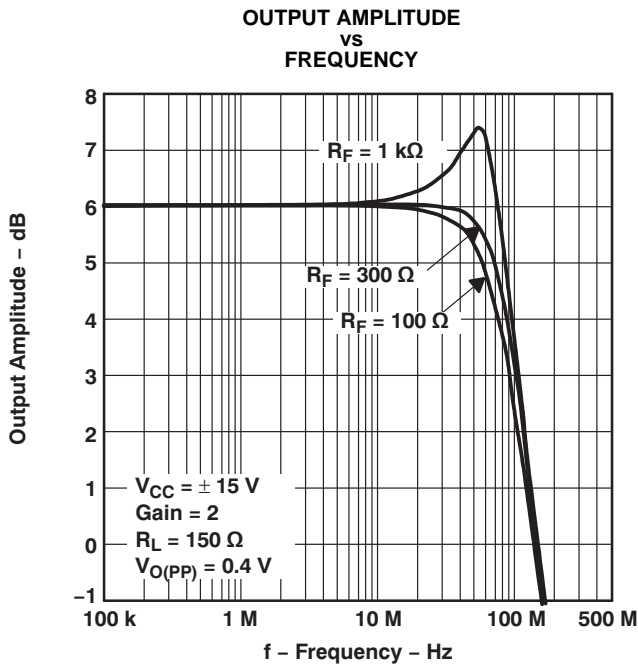

Figure 24.

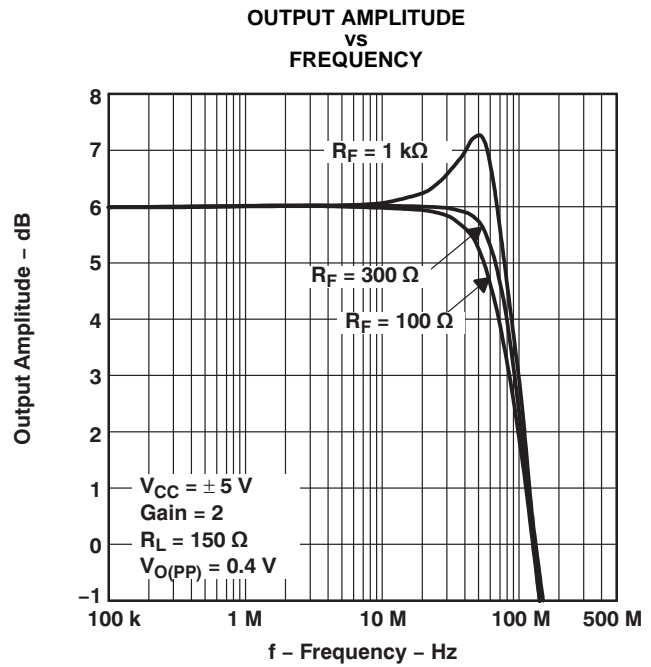

Figure 25.

PRODUCT PREVIEW

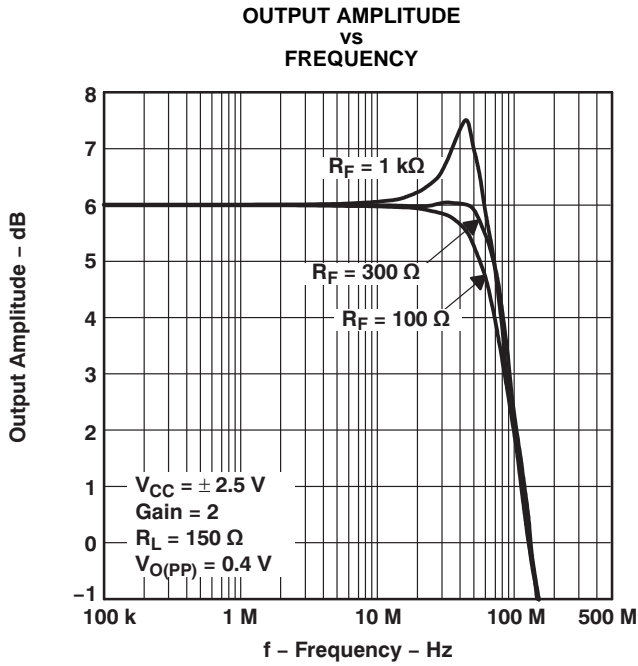

Figure 26.

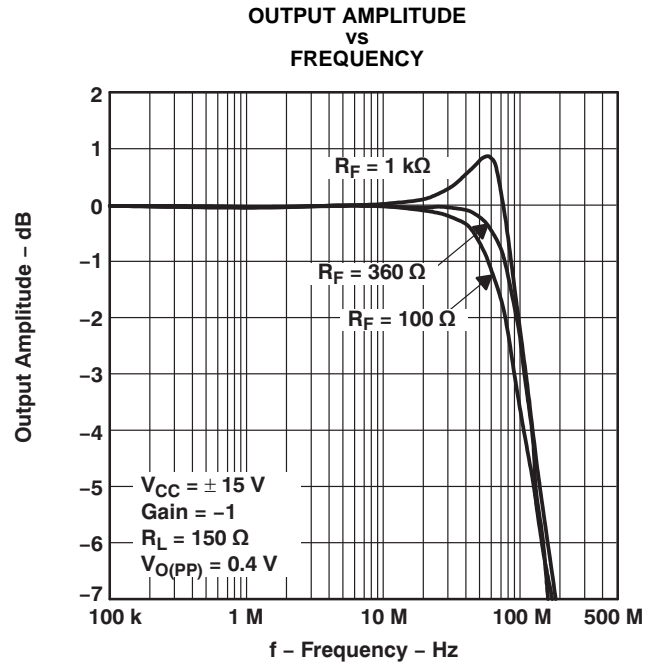

Figure 27.

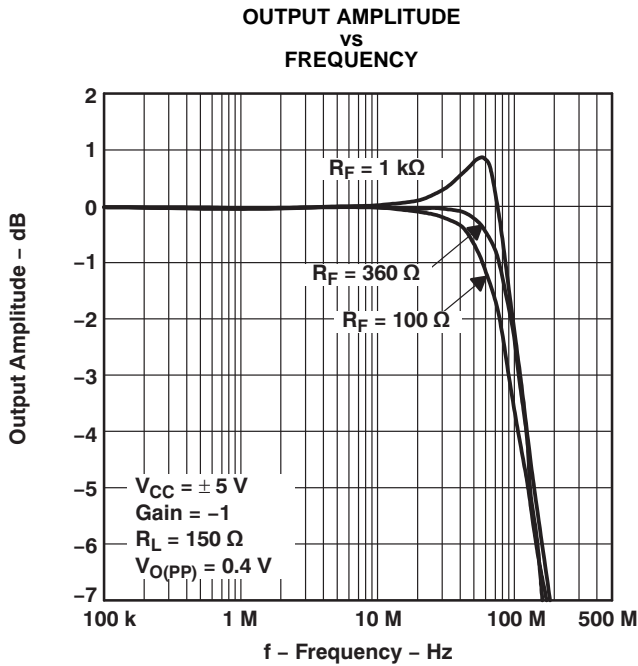

Figure 28.

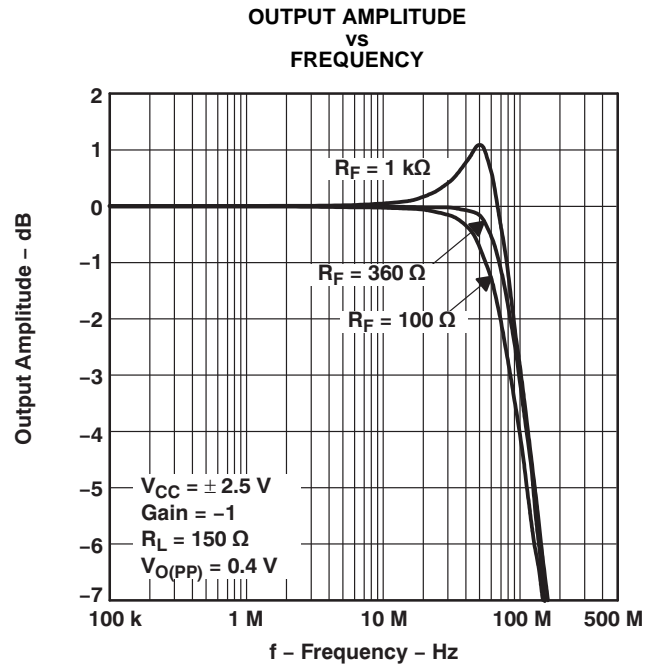

Figure 29.

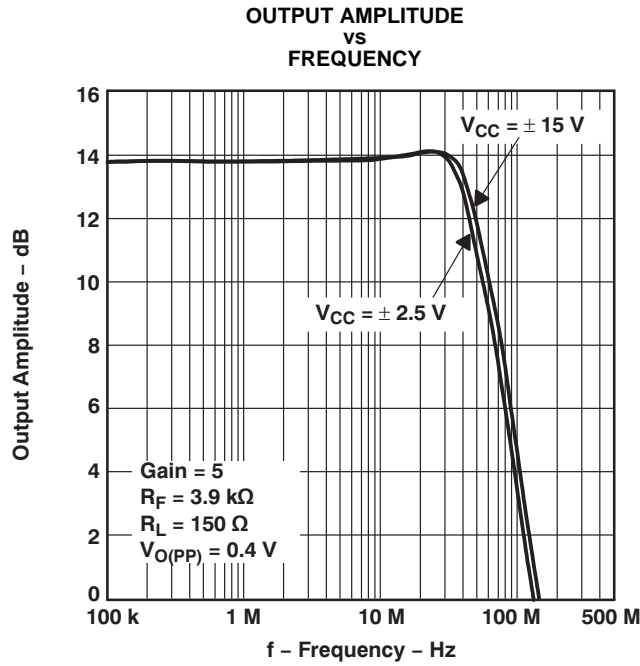

Figure 30.

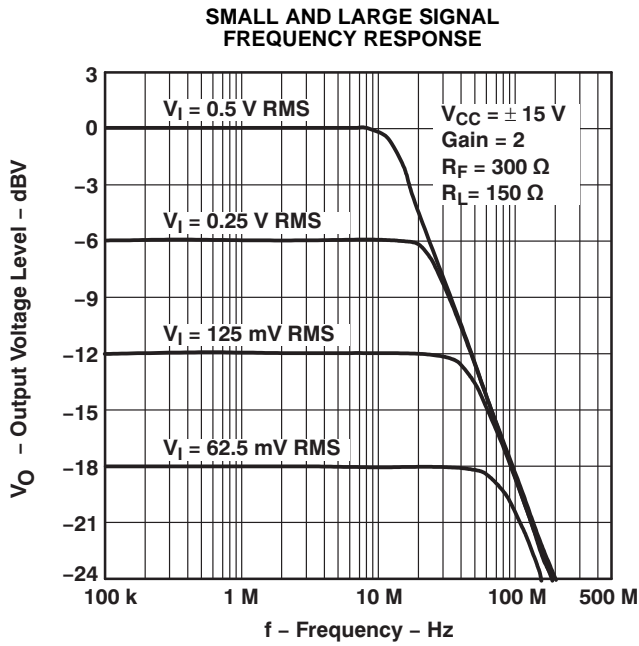

Figure 31.

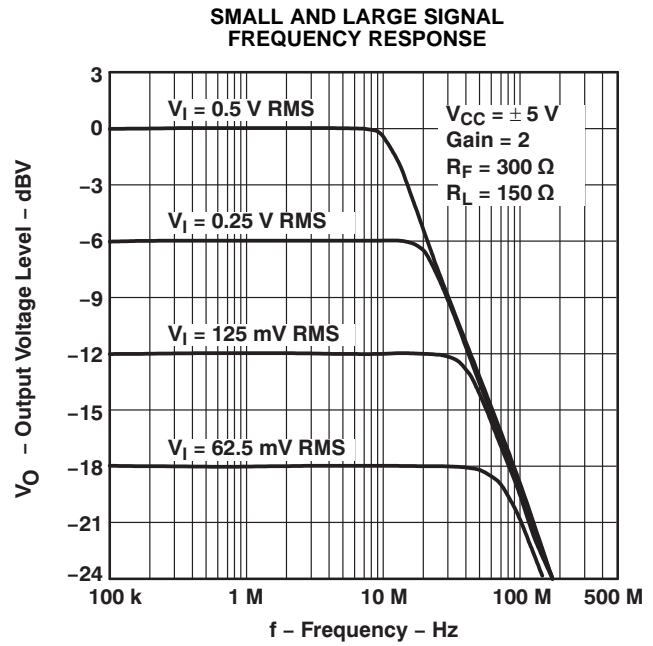

Figure 32.

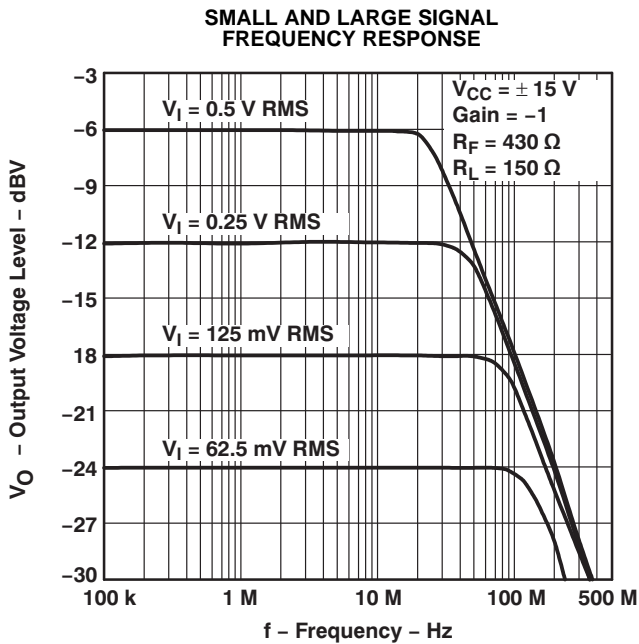

Figure 33.

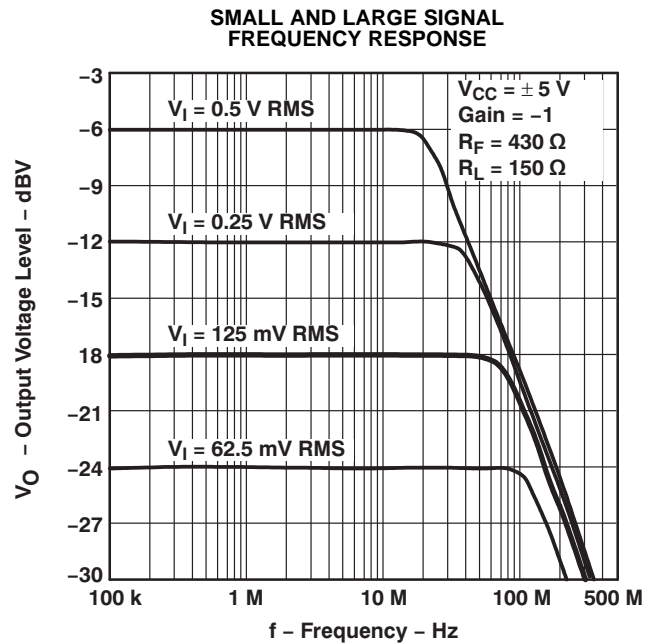

Figure 34.

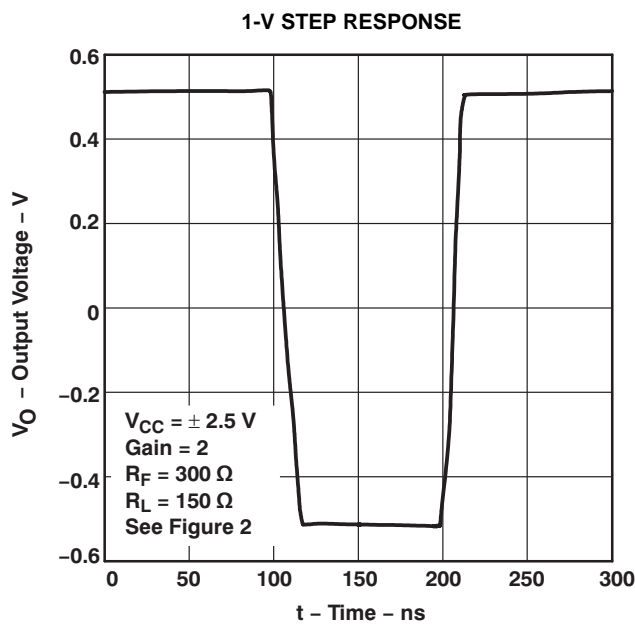

Figure 35.

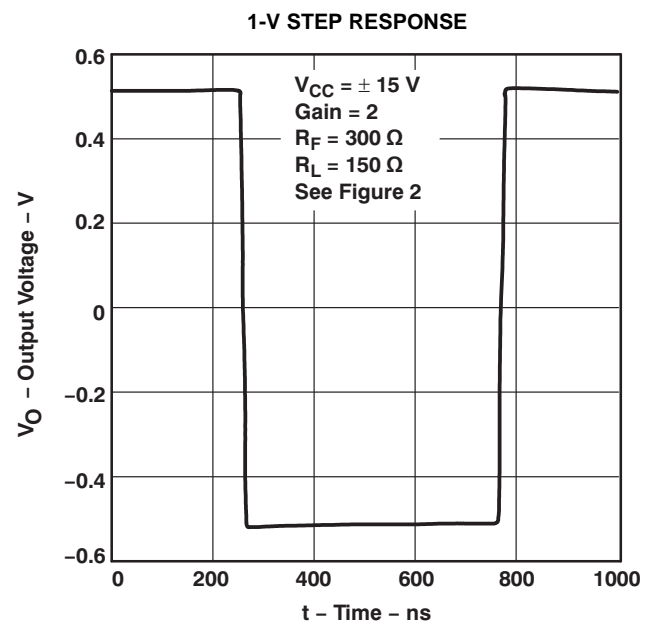

Figure 36.

PRODUCT PREVIEW

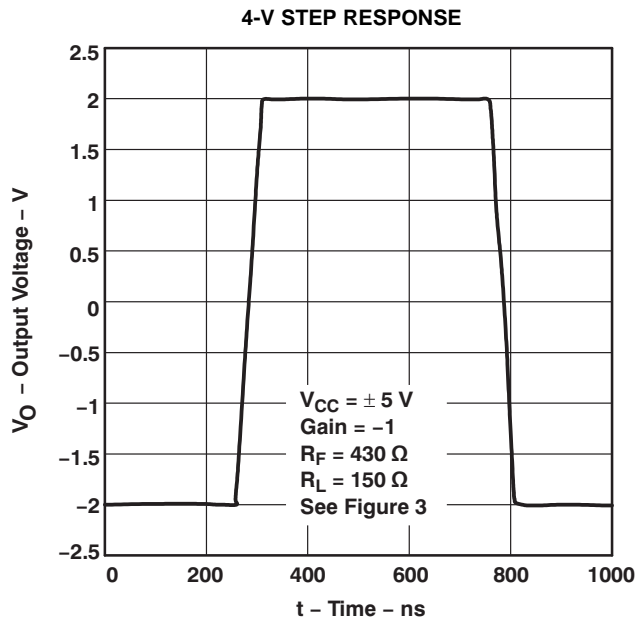

Figure 37.

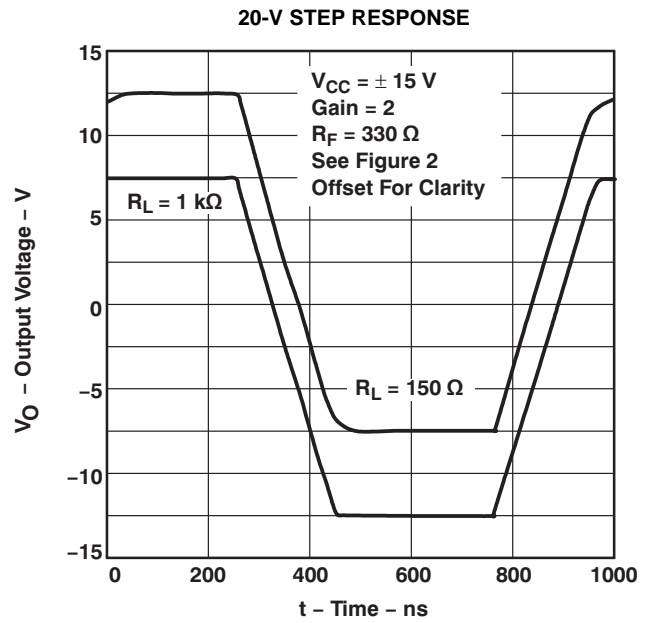

Figure 38.

PRODUCT PREVIEW

## APPLICATION INFORMATION

### THEORY OF OPERATION

The THS6062 is a high-speed, operational amplifier configured in a voltage-feedback architecture. It is built using a 30-V, dielectrically isolated, complementary bipolar process with NPN and PNP transistors possessing  $f_T$ s of several GHz. This results in an exceptionally high-performance amplifier that has a wide bandwidth, high slew rate, fast settling time, and low distortion. A simplified schematic is shown in [Figure 39](#).

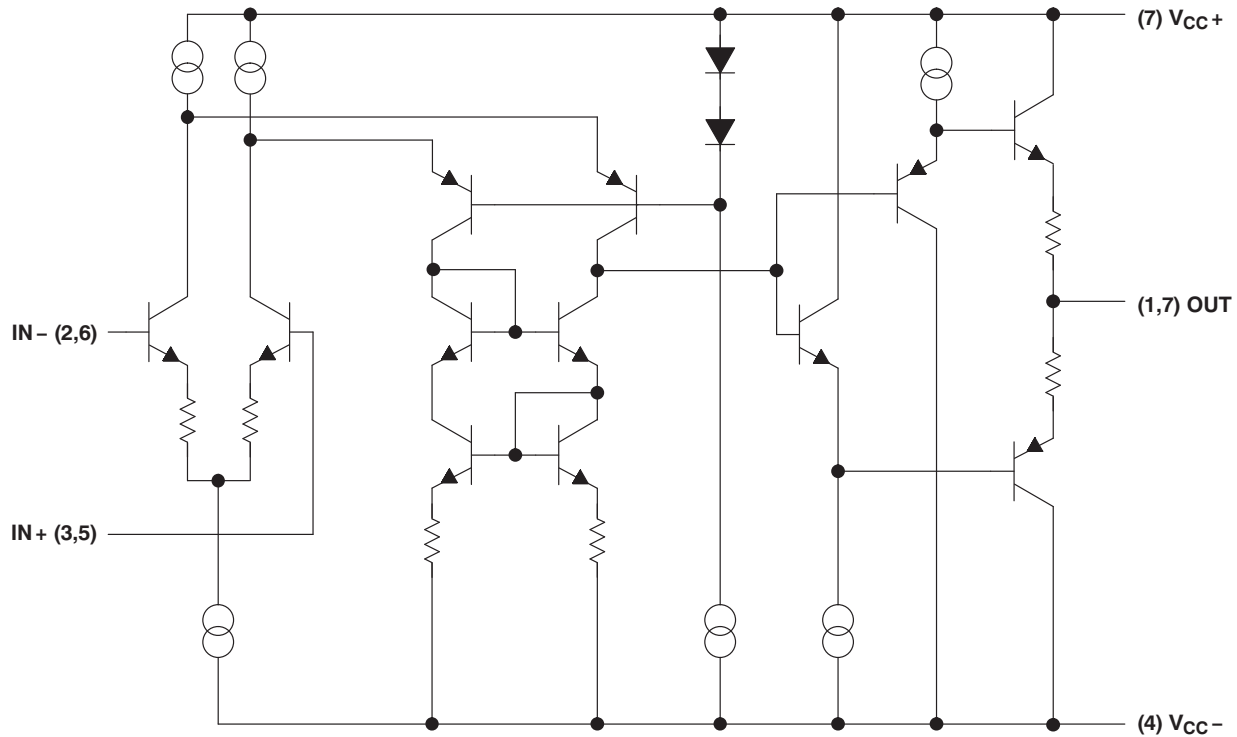

**Figure 39. THS6062 Simplified Schematic**

The ADSL remote terminal receive band consists of 255 separate carrier frequencies each with its own modulation and amplitude level. With such an implementation, it is imperative that signals received off the telephone line have as high a signal-to-noise ratio (SNR) as possible. This is because of the numerous sources of interference on the line. The best way to accomplish this high SNR is to have a low-noise receiver on the front-end. It is also important to have the lowest distortion possible to help minimize against interference within the ADSL carriers. The THS6062 was designed with these two priorities in mind.

By taking advantage of the superb characteristics of the complimentary bipolar process (BICOM), the THS6062 offers extremely low noise and distortion while maintaining a high bandwidth. There are some aspects that help minimize distortion in any amplifier. The first is to extend the bandwidth of the amplifier as high as possible without peaking. This allows the amplifier to eliminate any nonlinearities in the output signal. Another thing that helps to minimize distortion is to increase the load impedance seen by the amplifier, thereby reducing the currents in the output stage. This will help keep the output transistors in their linear amplification range and will also reduce the heating effects. This can be seen in [Figure 18](#) to [Figure 21](#), which show a 1-k $\Omega$  load distortion is much better than a 150- $\Omega$  load.

One client-side terminal circuit implementation, shown in Figure 40, uses a 1:2 transformer ratio. While creating a power and output voltage advantage for the line drivers, the 1:2 transformer ratio reduces the SNR for the received signals. The ADSL standard, ANSI T1.413, stipulates a noise power spectral density of  $-140$  dBm/Hz, which is equivalent to  $31.6$  nV/ $\sqrt{\text{Hz}}$  for a  $100\text{-}\Omega$  system. Although many amplifiers can reach this level of performance, actual ADSL system testing has indicated that the noise power spectral density may typically be  $\leq -150$  dBm/Hz, or  $\leq 10$  nV/ $\sqrt{\text{Hz}}$ . With a transformer ratio of 1:2, this number reduces to less than  $5$  nV/ $\sqrt{\text{Hz}}$ . The THS6062, with an equivalent input noise of  $1.6$  nV/ $\sqrt{\text{Hz}}$ , is an excellent choice for this application. Coupled with a very low  $1.2$  pA/ $\sqrt{\text{Hz}}$  equivalent input current noise and low value resistors, the THS6062 will ensure that the received signal SNR will be as high as possible.

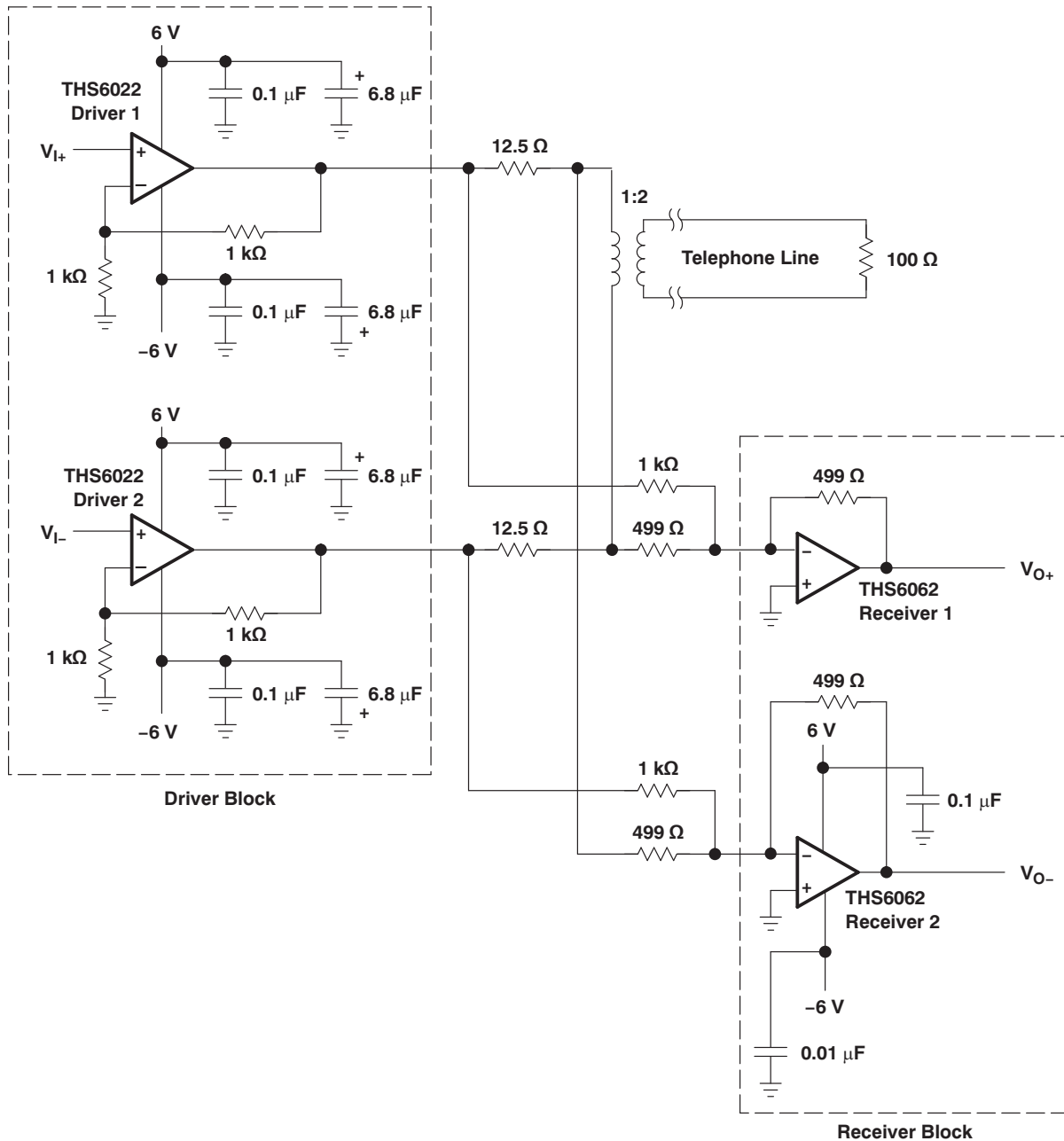

Figure 40. THS6062 Client-Side ADSL Application

PRODUCT PREVIEW

## NOISE CALCULATIONS AND NOISE FIGURE

Noise can cause errors on very small signals. This is especially true for the amplifying small signals. The noise model for current-feedback amplifiers (CFB) is the same as voltage-feedback amplifiers (VFB). The only difference between the two is that the CFB amplifiers generally specify different noise-current parameters for each input, while VFB amplifiers usually only specify one noise-current parameter. The noise model is shown in Figure 41. This model includes all of the noise sources as follows:

- $e_n$  = Amplifier internal voltage noise ( $\text{nV}/\sqrt{\text{Hz}}$ )
- $\text{IN}+$  = Noninverting current noise ( $\text{pA}/\sqrt{\text{Hz}}$ )
- $\text{IN}-$  = Inverting current noise ( $\text{pA}/\sqrt{\text{Hz}}$ )
- $e_{R_x}$  = Thermal voltage noise associated with each resistor ( $e_{R_x} = 4 kTR_x$ )

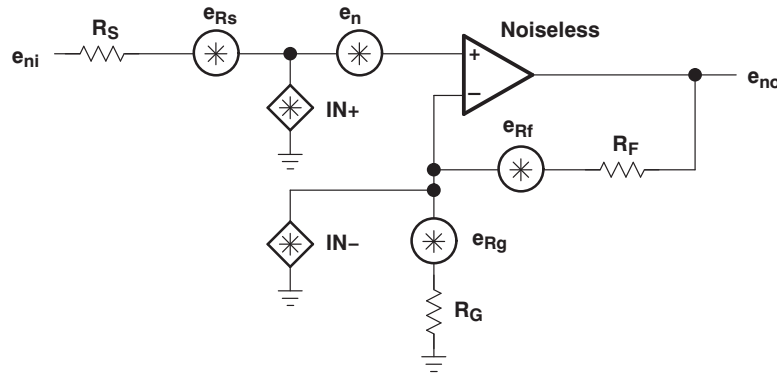

Figure 41. Noise Model

The total equivalent input noise density ( $e_{ni}$ ) is calculated by using the following equation:

$$e_{ni} = \sqrt{(e_n)^2 + (\text{IN}+ \times R_S)^2 + (\text{IN}- \times (R_F \parallel R_G))^2 + 4 kTR_S + 4 kT(R_F \parallel R_G)} \quad (1)$$

Where:

- $k$  = Boltzmann's constant =  $1.380658 \times 10^{-23}$
- $T$  = Temperature in degrees Kelvin ( $273 + ^\circ\text{C}$ )
- $R_F \parallel R_G$  = Parallel resistance of  $R_F$  and  $R_G$

To get the equivalent output noise of the amplifier, just multiply the equivalent input noise density ( $e_{ni}$ ) by the overall amplifier gain ( $A_V$ ).

$$e_{no} = e_{ni} A_V = e_{ni} \left( 1 + \frac{R_F}{R_G} \right) \text{ (Noninverting Case)} \quad (2)$$

As the previous equations show, to keep noise at a minimum, small-value resistors should be used. As the closed-loop gain is increased (by reducing  $R_G$ ), the input noise is reduced considerably because of the parallel resistance term. This leads to the general conclusion that the most dominant noise sources are the source resistor ( $R_S$ ) and the internal amplifier noise voltage ( $e_n$ ). Because noise is summed in a root-mean-squares method, noise sources smaller than 25% of the largest noise source can be effectively ignored. This can greatly simplify the formula and make noise calculations much easier to calculate.

For more information on noise analysis, refer to the *Noise Analysis* section in *Operational Amplifier Circuits Applications Report (SLVA043)*.

This brings up another noise measurement usually preferred in RF applications, the noise figure (NF). Noise figure is a measure of noise degradation caused by the amplifier. The value of the source resistance must be defined and is typically  $50 \Omega$  in RF applications.

$$NF = 10\log \left[ \frac{e_{ni}^2}{(e_{Rs})^2} \right] \tag{3}$$

Because the dominant noise components are generally the source resistance and the internal amplifier noise voltage, we can approximate the noise figure as:

$$NF = 10\log \left[ 1 + \frac{\left[ (e_n)^2 + (IN + \times R_S)^2 \right]}{4 kTR_S} \right] \tag{4}$$

Figure 42 shows the noise figure graph for the THS6062.

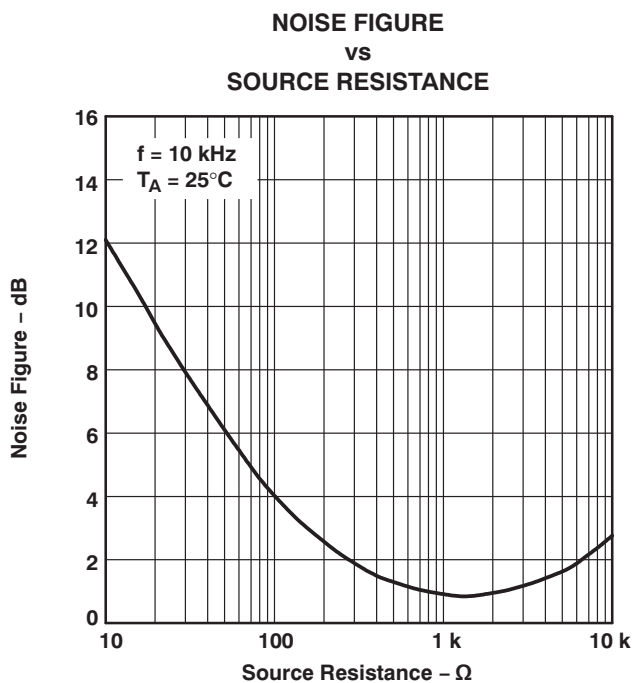

Figure 42. Noise Figure vs Source Resistance

## OPTIMIZING FREQUENCY RESPONSE

Internal frequency compensation of the THS6062 was selected to provide very wide bandwidth performance and still maintain a very low noise floor. In order to meet these performance requirements, the THS6062 must have a minimum gain of 2 (–1). Because everything is referred to the noninverting terminal of an operational amplifier, the noise gain in a  $G = -1$  configuration is the same as in a  $G = 2$  configuration.

One of the keys to maintaining a smooth frequency response, and hence, a stable pulse response, is to pay particular attention to the inverting terminal. Any stray capacitance at this node causes peaking in the frequency response (see Figure 43 and Figure 44). There are two things that can be done to help minimize this effect. The first is to simply remove any ground planes under the inverting terminal of the amplifier. This also includes the trace that connects to this terminal. Additionally, the length of this trace should be minimized. The capacitance at this node causes a lag in the voltage being fed back due to the charging and discharging of the stray capacitance. If this lag becomes too long, the amplifier will not be able to correctly keep the noninverting terminal voltage at the same potential as the inverting terminal's voltage. Peaking and possibly oscillations will then occur.

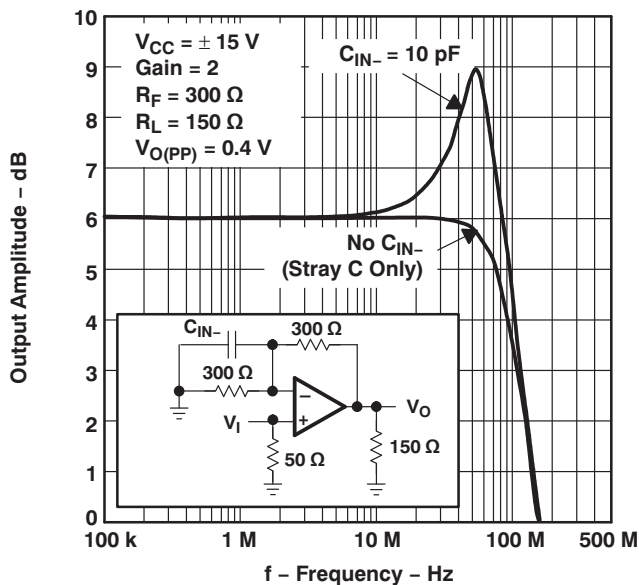

Figure 43.

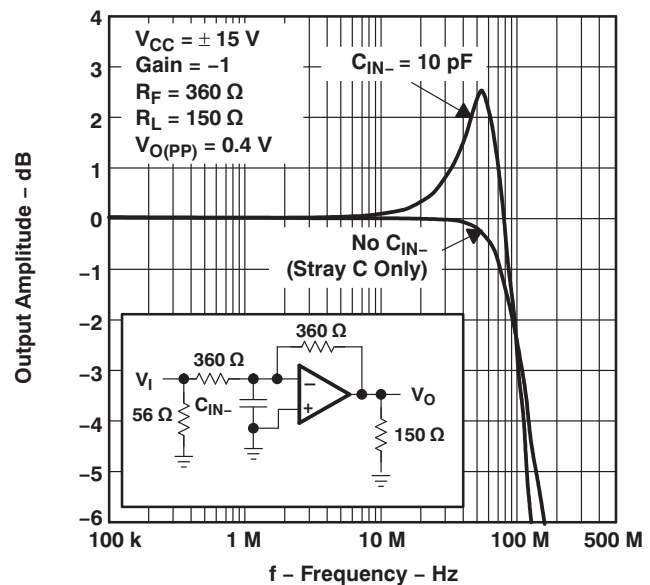

Figure 44.

The next thing that helps to maintain a smooth frequency response is to keep the feedback resistor ( $r_f$ ) and the gain resistor ( $r_g$ ) values fairly low. These two resistors are effectively in parallel when looking at the ac small-signal response. This is why in Figure 30, a feedback resistor of 3.9 k $\Omega$  with a gain resistor of 1 k $\Omega$  only shows a small peaking in the frequency response. The parallel resistance is only 800  $\Omega$ . This value, in conjunction with a very small stray capacitance test PCB, forms a zero on the edge of the amplifier's natural frequency response. To eliminate this peaking, all that needs to be done is to reduce the feedback and gain resistances. One other way to compensate for this stray capacitance is to add a small capacitor in parallel with the feedback resistor. This helps to neutralize the effects of the stray capacitance. To keep this zero out of the operating range, the stray capacitance and resistor value's time constant must be kept low. But, as can be seen in Figure 23 to Figure 28, a value too low starts to reduce the bandwidth of the amplifier. Table 1 shows some recommended feedback resistors to be used with the THS6062.

Table 1. Recommended Feedback Resistors

GAIN	$R_f$ for $V_{CC} = \pm 15\text{ V}, \pm 5\text{ V}, 5\text{ V}$
2	300 $\Omega$
-1	360 $\Omega$
5	3.3 k $\Omega$ (low stray-c PCB only)

### DRIVING A CAPACITIVE LOAD

Driving capacitive loads with high performance amplifiers is not a problem as long as certain precautions are taken. The first is to realize that the THS6062 has been internally compensated to maximize its bandwidth and slew rate performance. When the amplifier is compensated in this manner, capacitive loading directly on the output will decrease the device's phase margin leading to high frequency ringing or oscillations. Therefore, for capacitive loads of greater than 10 pF, it is recommended that a resistor be placed in series with the output of the amplifier, as shown in Figure 45. A minimum value of 20 Ω should work well for most applications. For example, in 75-Ω transmission systems, setting the series resistor value to 75 Ω both isolates any capacitance loading and provides the proper line impedance matching at the source end.

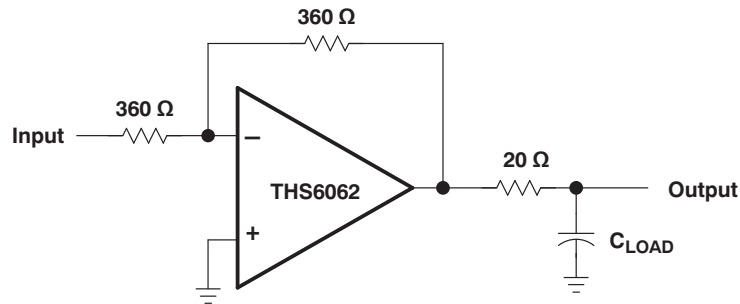
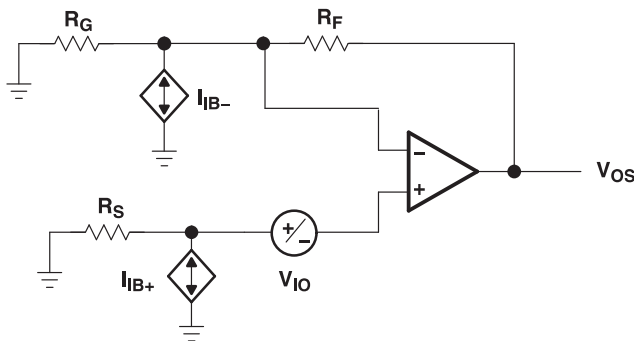

Figure 45. Driving a Capacitive Load

### OFFSET VOLTAGE

The output offset voltage, ( $V_{OS}$ ) is the sum of the input offset voltage ( $V_{IO}$ ) and both input bias currents ( $I_{IB}$ ) times the corresponding gains. The following schematic and formula are used to calculate the output offset voltage:



$$V_{OS} = (\pm V_{IO} \pm I_{IB+} R_S) \left( 1 + \frac{R_F}{R_G} \right) \pm I_{IB-} R_F$$

Figure 46. Output Offset Voltage Model

## CIRCUIT LAYOUT CONSIDERATIONS

In order to achieve the high-frequency performance of the THS6062, it is essential that proper printed-circuit board high frequency design techniques be followed. A general set of guidelines is given below. In addition, a THS6062 evaluation board is available to use as a guide for layout or for evaluating the device performance.

- **Ground planes**—It is highly recommended that a ground plane be used on the board to provide all components with a low inductive ground connection. However, in the areas of the amplifier inputs and output, the ground plane can be removed to minimize the stray capacitance.
- **Proper power supply decoupling**—Use a 6.8- $\mu$ F tantalum capacitor in parallel with a 0.1- $\mu$ F ceramic capacitor on each supply terminal. It may be possible to share the tantalum capacitor among several amplifiers depending on the application, but a 0.1- $\mu$ F ceramic capacitor should always be used on the supply terminal of every amplifier. In addition, the 0.1- $\mu$ F capacitor should be placed as close as possible to the supply terminal. As this distance increases, the inductance in the connecting trace makes the capacitor less effective. The designer should strive for distances of less than 0.1 inches between the device power terminals and the ceramic capacitors.
- **Sockets**—Sockets are not recommended for high-speed operational amplifiers. The additional lead inductance in the socket pins will often lead to stability problems. Surface-mount packages soldered directly to the printed-circuit board is the best implementation.
- **Short trace runs/compact part placements**—Optimum high frequency performance is achieved when stray series inductance has been minimized. To realize this, the circuit layout should be made as compact as possible, thereby minimizing the length of all trace runs. Particular attention should be paid to the inverting input of the amplifier. Its length should be kept as short as possible. This will help to minimize stray capacitance at the input of the amplifier.
- **Surface-mount passive components**—Using surface-mount passive components is recommended for high frequency amplifier circuits for several reasons. First, because of the extremely low lead inductance of surface-mount components, the problem with stray series inductance is greatly reduced. Second, the small size of surface-mount components naturally leads to a more compact layout, thereby minimizing both stray inductance and capacitance. If leaded components are used, it is recommended that the lead lengths be kept as short as possible.

## GENERAL PowerPAD DESIGN CONSIDERATIONS

The THS6062 is available packaged in a thermally-enhanced DGN package, which is a member of the PowerPAD family of packages. This package is constructed using a downset leadframe upon which the die is mounted [see [Figure 47\(a\)](#) and [Figure 47\(b\)](#)]. This arrangement results in the lead frame being exposed as a thermal pad on the underside of the package [see [Figure 47\(c\)](#)]. Because this thermal pad has direct thermal contact with the die, excellent thermal performance can be achieved by providing a good thermal path away from the thermal pad.

The PowerPAD package allows for both assembly and thermal management in one manufacturing operation. During the surface-mount solder operation (when the leads are being soldered), the thermal pad can also be soldered to a copper area underneath the package. Through the use of thermal paths within this copper area, heat can be conducted away from the package into either a ground plane or other heat dissipating device.

The PowerPAD package represents a breakthrough in combining the small area and ease of assembly of surface mount with the, heretofore, awkward mechanical methods of heat sinking.

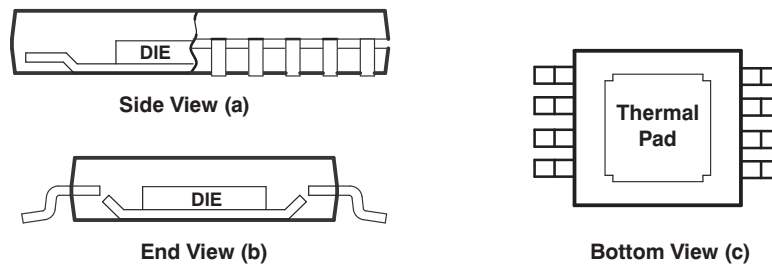

**Figure 47. Views of Thermally Enhanced DGN Package**

Although there are many ways to properly heat sink this device, the following steps illustrate the recommended approach.

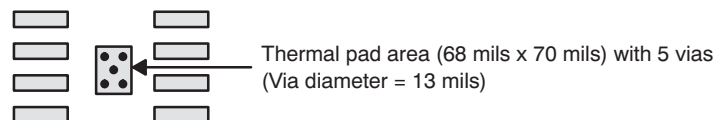

**Figure 48. PowerPAD PCB Etch and Via Pattern**

1. Prepare the PCB with a top side etch pattern as shown in [Figure 48](#). There should be etch for the leads as well as etch for the thermal pad.
2. Place five holes in the area of the thermal pad. These holes should be 13 mils in diameter. They are kept small so that solder wicking through the holes is not a problem during reflow.
3. Additional vias may be placed anywhere along the thermal plane outside of the thermal pad area. This helps dissipate the heat generated by the THS6062DGN IC. These additional vias may be larger than the 13-mil diameter vias directly under the thermal pad. They can be larger because they are not in the thermal pad area to be soldered so that wicking is not a problem.
4. Connect all holes to the internal ground plane.
5. When connecting these holes to the ground plane, do not use the typical web or spoke via connection methodology. Web connections have a high thermal resistance connection that is useful for slowing the heat transfer during soldering operations. This makes the soldering of vias that have plane connections easier. In this application, however, low thermal resistance is desired for the most efficient heat transfer. Therefore, the holes under the THS6062DGN package should make their connection to the internal ground plane with a complete connection around the entire circumference of the plated-through hole.
6. The top-side solder mask should leave the terminals of the package and the thermal pad area with its five holes exposed. The bottom-side solder mask should cover the five holes of the thermal pad area. This prevents solder from being pulled away from the thermal pad area during the reflow process.
7. Apply solder paste to the exposed thermal pad area and all of the IC terminals.
8. With these preparatory steps in place, the THS6062DGN IC is simply placed in position and run through the solder reflow operation as any standard surface-mount component. This results in a part that is properly

installed.

The actual thermal performance achieved with the THS6062DGN in its PowerPAD package depends on the application. In the example above, if the size of the internal ground plane is approximately 3 inches × 3 inches, then the expected thermal coefficient,  $\theta_{JA}$ , is about 58.4°C/W. For comparison, the non-PowerPAD version of the THS6062 IC (SOIC) is shown. For a given  $\theta_{JA}$ , the maximum power dissipation is shown in Figure 49 and is calculated by the following formula:

$$P_D = \left( \frac{T_{MAX} - T_A}{\theta_{JA}} \right) \quad (5)$$

Where:

$P_D$  = Maximum power dissipation of THS6062 IC (watts)

$T_{MAX}$  = Absolute maximum junction temperature (150°C)

$T_A$  = Free-ambient air temperature (°C)

$\theta_{JA} = \theta_{JC} + \theta_{CA}$

$\theta_{JC}$  = Thermal coefficient from junction to case

$\theta_{CA}$  = Thermal coefficient from case to ambient air (°C/W)

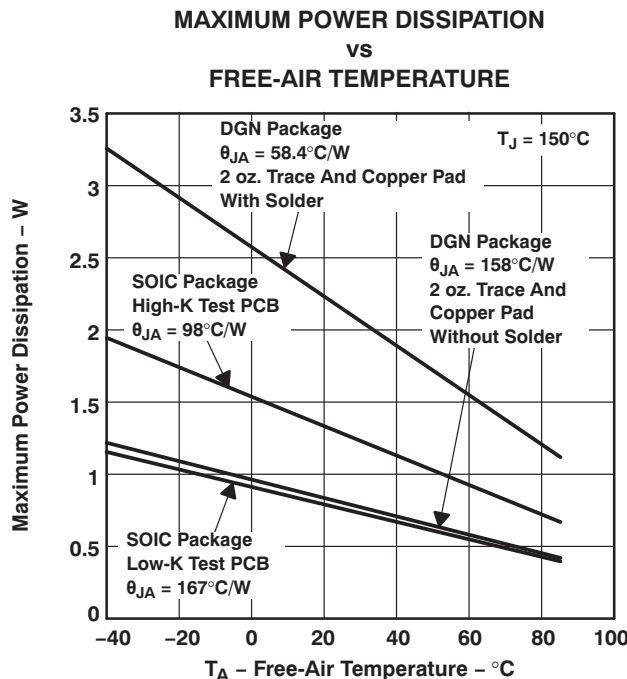

NOTE: Results are with no air flow and PCB size = 3"× 3"

Figure 49. Maximum Power Dissipation vs Free-Air Temperature

More complete details of the PowerPAD installation process and thermal management techniques can be found in the Texas Instruments Technical Brief, PowerPAD Thermally Enhanced Package. This document can be found at the TI web site ([www.ti.com](http://www.ti.com)) by searching on the key word PowerPAD. The document can also be ordered through your local TI sales office. Refer to literature number [SLMA002](#) when ordering.

The next thing that should be considered is the package constraints. The two sources of heat within an amplifier are quiescent power and output power. The designer should never forget about the quiescent heat generated within the device, especially a multi-amplifier device. Because these devices have linear output stages (Class A-B), most of the heat dissipation is at low output voltages with high output currents. Figure 50 and Figure 51 show this effect, along with the quiescent heat, with an ambient air temperature of 50°C. When using  $V_{CC} = 5$  V or  $\pm 5$  V, there is generally not a heat problem, even with SOIC packages. But, when using  $V_{CC} = \pm 15$  V, the SOIC package is severely limited in the amount of heat it can dissipate. The other key factor when looking at these graphs is how the devices are mounted on the PCB. The PowerPAD devices are extremely useful for heat

dissipation. But the device should always be soldered to a copper plane to fully use the heat dissipation properties of the PowerPAD. The SOIC package, on the other hand, is highly dependent on how it is mounted on the PCB. As more trace and copper area is placed around the device,  $\theta_{JA}$  decreases and the heat dissipation capability increases. The currents and voltages shown in these graphs are for the total package. Because the THS6062 is a dual amplifier, the sum of the RMS output currents and voltages should be used to choose the proper package.

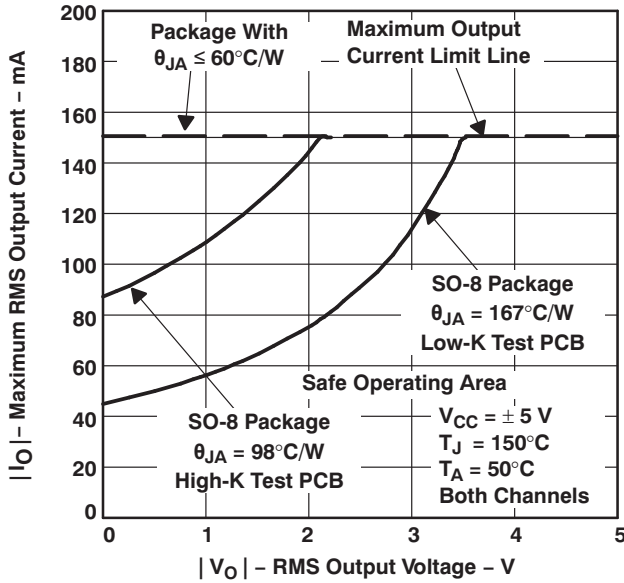

Figure 50.

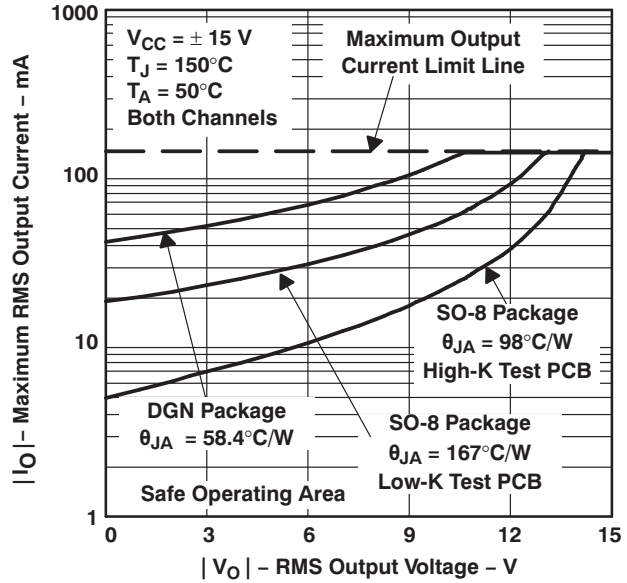

Figure 51.

### EVALUATION BOARD

An evaluation board is available for the THS6062 ([SLOP221](#)). This board has been configured for very low parasitic capacitance in order to realize the full performance of the amplifier. For more information, refer to the *THS6062 EVM User's Guide* ([SLOU036](#)) To order the evaluation board contact your local TI sales office or distributor.

**PACKAGING INFORMATION**

Orderable Device	Status (1)	Package Type	Package Drawing	Pins	Package Qty	Eco Plan (2)	Lead finish/ Ball material (6)	MSL Peak Temp (3)	Op Temp (°C)	Device Marking (4/5)	Samples
THS6062CD	ACTIVE	SOIC	D	8	75	RoHS & Green	NIPDAU	Level-1-260C-UNLIM	0 to 70	6062C	<a href="#">Samples</a>
THS6062CDGNR	ACTIVE	HVSSOP	DGN	8	2500	RoHS & Green	NIPDAU	Level-1-260C-UNLIM	0 to 70	ABE	<a href="#">Samples</a>
THS6062ID	ACTIVE	SOIC	D	8	75	RoHS & Green	NIPDAU	Level-1-260C-UNLIM	-40 to 85	6062I	<a href="#">Samples</a>
THS6062IDGNR	ACTIVE	HVSSOP	DGN	8	2500	RoHS & Green	NIPDAU	Level-1-260C-UNLIM		ABH	<a href="#">Samples</a>

(1) The marketing status values are defined as follows:

**ACTIVE:** Product device recommended for new designs.

**LIFEBUY:** TI has announced that the device will be discontinued, and a lifetime-buy period is in effect.

**NRND:** Not recommended for new designs. Device is in production to support existing customers, but TI does not recommend using this part in a new design.

**PREVIEW:** Device has been announced but is not in production. Samples may or may not be available.

**OBSELETE:** TI has discontinued the production of the device.

(2) **RoHS:** TI defines "RoHS" to mean semiconductor products that are compliant with the current EU RoHS requirements for all 10 RoHS substances, including the requirement that RoHS substance do not exceed 0.1% by weight in homogeneous materials. Where designed to be soldered at high temperatures, "RoHS" products are suitable for use in specified lead-free processes. TI may reference these types of products as "Pb-Free".

**RoHS Exempt:** TI defines "RoHS Exempt" to mean products that contain lead but are compliant with EU RoHS pursuant to a specific EU RoHS exemption.

**Green:** TI defines "Green" to mean the content of Chlorine (Cl) and Bromine (Br) based flame retardants meet JS709B low halogen requirements of <=1000ppm threshold. Antimony trioxide based flame retardants must also meet the <=1000ppm threshold requirement.

(3) MSL, Peak Temp. - The Moisture Sensitivity Level rating according to the JEDEC industry standard classifications, and peak solder temperature.

(4) There may be additional marking, which relates to the logo, the lot trace code information, or the environmental category on the device.

(5) Multiple Device Markings will be inside parentheses. Only one Device Marking contained in parentheses and separated by a "-" will appear on a device. If a line is indented then it is a continuation of the previous line and the two combined represent the entire Device Marking for that device.

(6) Lead finish/Ball material - Orderable Devices may have multiple material finish options. Finish options are separated by a vertical ruled line. Lead finish/Ball material values may wrap to two lines if the finish value exceeds the maximum column width.

**Important Information and Disclaimer:**The information provided on this page represents TI's knowledge and belief as of the date that it is provided. TI bases its knowledge and belief on information provided by third parties, and makes no representation or warranty as to the accuracy of such information. Efforts are underway to better integrate information from third parties. TI has taken and

continues to take reasonable steps to provide representative and accurate information but may not have conducted destructive testing or chemical analysis on incoming materials and chemicals. TI and TI suppliers consider certain information to be proprietary, and thus CAS numbers and other limited information may not be available for release.

In no event shall TI's liability arising out of such information exceed the total purchase price of the TI part(s) at issue in this document sold by TI to Customer on an annual basis.

**TAPE AND REEL INFORMATION**

**QUADRANT ASSIGNMENTS FOR PIN 1 ORIENTATION IN TAPE**



\*All dimensions are nominal

Device	Package Type	Package Drawing	Pins	SPQ	Reel Diameter (mm)	Reel Width W1 (mm)	A0 (mm)	B0 (mm)	K0 (mm)	P1 (mm)	W (mm)	Pin1 Quadrant
THS6062CDGNR	HVSSOP	DGN	8	2500	330.0	12.4	5.3	3.4	1.4	8.0	12.0	Q1
THS6062IDGNR	HVSSOP	DGN	8	2500	330.0	12.4	5.3	3.4	1.4	8.0	12.0	Q1

**TAPE AND REEL BOX DIMENSIONS**

\*All dimensions are nominal

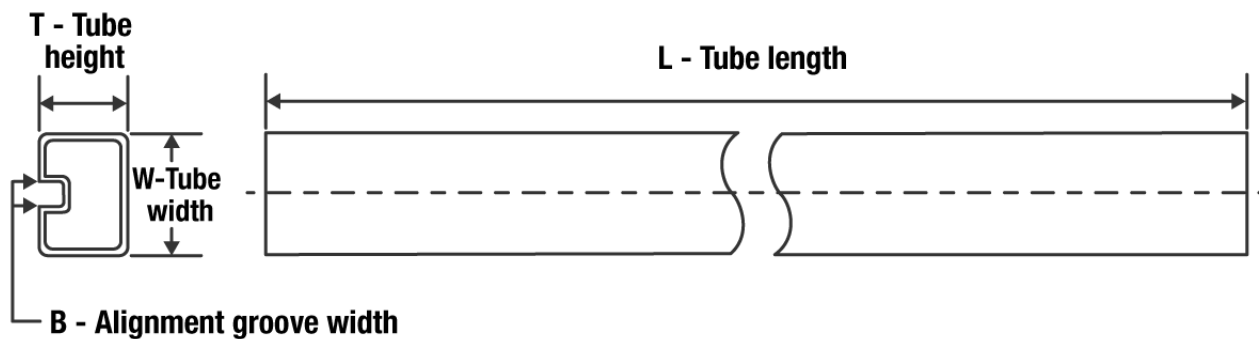
Device	Package Type	Package Drawing	Pins	SPQ	Length (mm)	Width (mm)	Height (mm)
THS6062CDGNR	HVSSOP	DGN	8	2500	358.0	335.0	35.0
THS6062IDGNR	HVSSOP	DGN	8	2500	358.0	335.0	35.0

**TUBE**

\*All dimensions are nominal

Device	Package Name	Package Type	Pins	SPQ	L (mm)	W (mm)	T (μm)	B (mm)
THS6062CD	D	SOIC	8	75	505.46	6.76	3810	4
THS6062ID	D	SOIC	8	75	505.46	6.76	3810	4

## GENERIC PACKAGE VIEW

**DGN 8**

**PowerPAD VSSOP - 1.1 mm max height**

3 x 3, 0.65 mm pitch

SMALL OUTLINE PACKAGE

This image is a representation of the package family, actual package may vary.  
Refer to the product data sheet for package details.

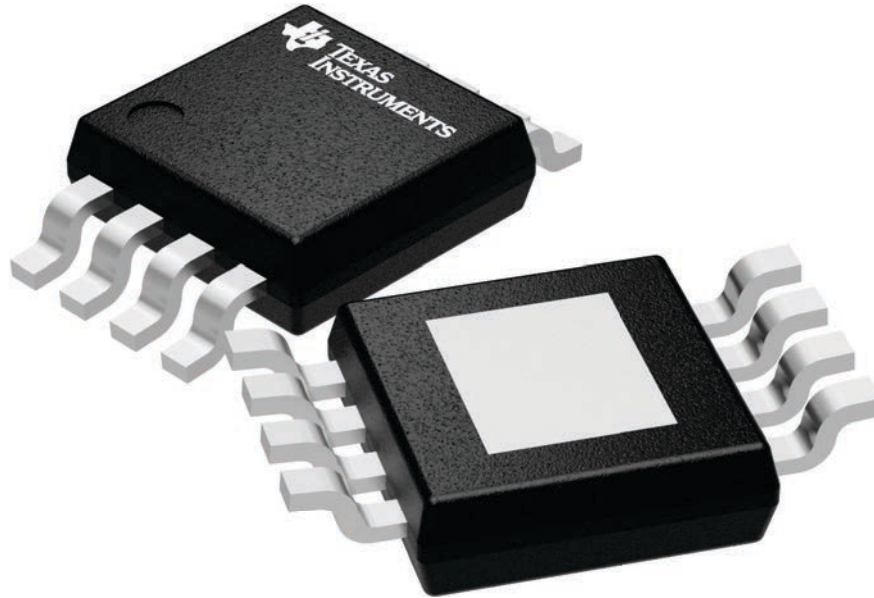

4225482/A



# EXAMPLE BOARD LAYOUT

DGN0008D

PowerPAD™ VSSOP - 1.1 mm max height

SMALL OUTLINE PACKAGE

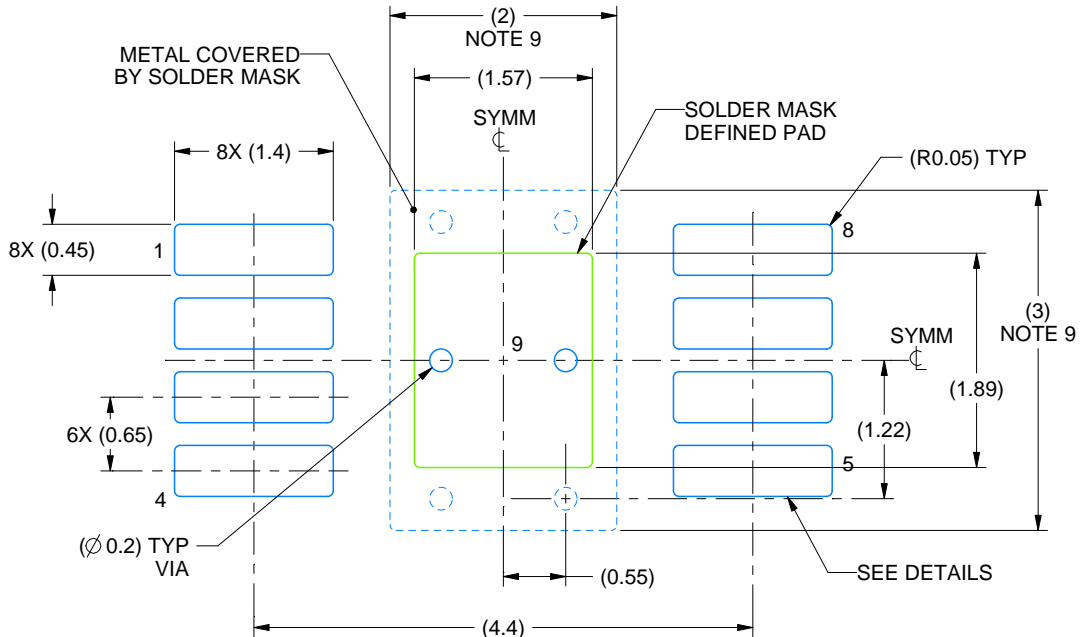

LAND PATTERN EXAMPLE  
EXPOSED METAL SHOWN  
SCALE: 15X

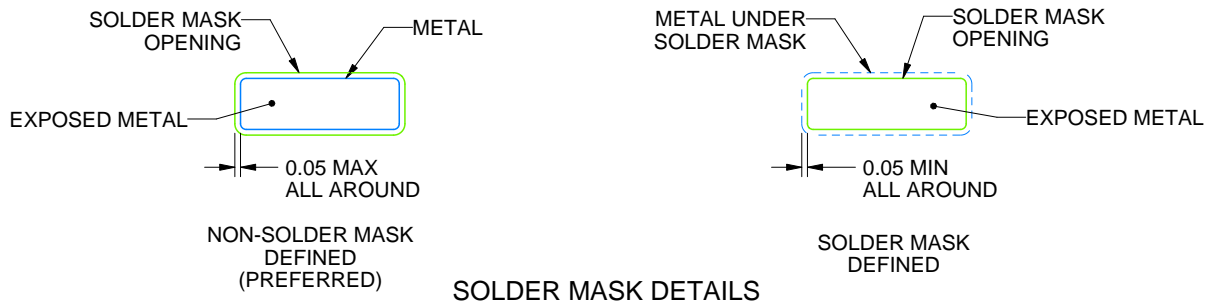

4225481/A 11/2019

NOTES: (continued)

6. Publication IPC-7351 may have alternate designs.
7. Solder mask tolerances between and around signal pads can vary based on board fabrication site.
8. Vias are optional depending on application, refer to device data sheet. If any vias are implemented, refer to their locations shown on this view. It is recommended that vias under paste be filled, plugged or tented.
9. Size of metal pad may vary due to creepage requirement.

# EXAMPLE STENCIL DESIGN

DGN0008D

PowerPAD™ VSSOP - 1.1 mm max height

SMALL OUTLINE PACKAGE

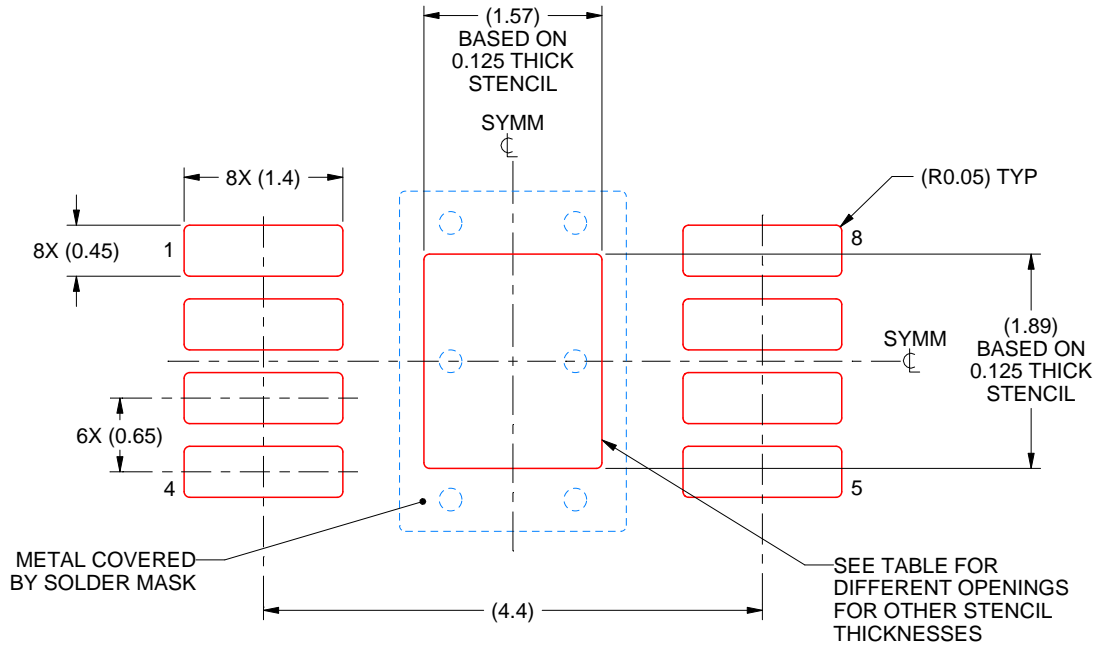

**SOLDER PASTE EXAMPLE**  
EXPOSED PAD 9:  
100% PRINTED SOLDER COVERAGE BY AREA  
SCALE: 15X

STENCIL THICKNESS	SOLDER STENCIL OPENING
0.1	1.76 X 2.11
0.125	1.57 X 1.89 (SHOWN)
0.15	1.43 X 1.73
0.175	1.33 X 1.60

4225481/A 11/2019

NOTES: (continued)

10. Laser cutting apertures with trapezoidal walls and rounded corners may offer better paste release. IPC-7525 may have alternate design recommendations.
11. Board assembly site may have different recommendations for stencil design.



D0008A

# PACKAGE OUTLINE

SOIC - 1.75 mm max height

SMALL OUTLINE INTEGRATED CIRCUIT



4214825/C 02/2019

### NOTES:

- Linear dimensions are in inches [millimeters]. Dimensions in parenthesis are for reference only. Controlling dimensions are in inches. Dimensioning and tolerancing per ASME Y14.5M.
- This drawing is subject to change without notice.
- This dimension does not include mold flash, protrusions, or gate burrs. Mold flash, protrusions, or gate burrs shall not exceed .006 [0.15] per side.
- This dimension does not include interlead flash.
- Reference JEDEC registration MS-012, variation AA.

# EXAMPLE BOARD LAYOUT

D0008A

SOIC - 1.75 mm max height

SMALL OUTLINE INTEGRATED CIRCUIT



LAND PATTERN EXAMPLE  
 EXPOSED METAL SHOWN  
 SCALE:8X

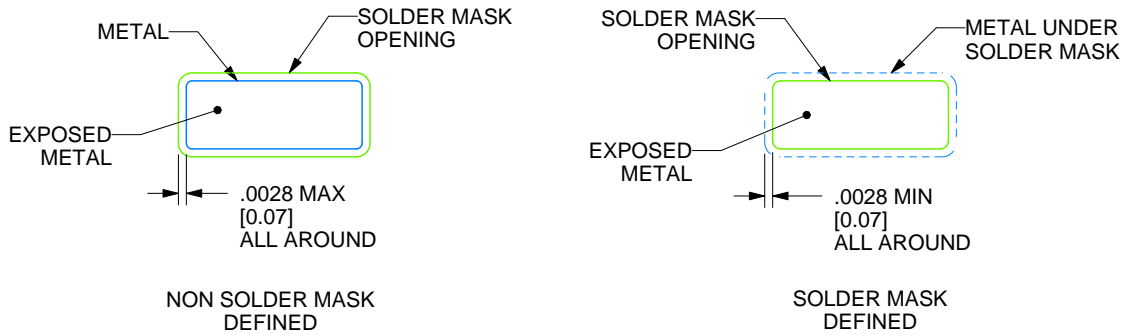

SOLDER MASK DETAILS

4214825/C 02/2019

NOTES: (continued)

- 6. Publication IPC-7351 may have alternate designs.
- 7. Solder mask tolerances between and around signal pads can vary based on board fabrication site.

# EXAMPLE STENCIL DESIGN

D0008A

SOIC - 1.75 mm max height

SMALL OUTLINE INTEGRATED CIRCUIT



SOLDER PASTE EXAMPLE  
BASED ON .005 INCH [0.125 MM] THICK STENCIL  
SCALE:8X

4214825/C 02/2019

NOTES: (continued)

8. Laser cutting apertures with trapezoidal walls and rounded corners may offer better paste release. IPC-7525 may have alternate design recommendations.
9. Board assembly site may have different recommendations for stencil design.

## IMPORTANT NOTICE AND DISCLAIMER

TI PROVIDES TECHNICAL AND RELIABILITY DATA (INCLUDING DATA SHEETS), DESIGN RESOURCES (INCLUDING REFERENCE DESIGNS), APPLICATION OR OTHER DESIGN ADVICE, WEB TOOLS, SAFETY INFORMATION, AND OTHER RESOURCES "AS IS" AND WITH ALL FAULTS, AND DISCLAIMS ALL WARRANTIES, EXPRESS AND IMPLIED, INCLUDING WITHOUT LIMITATION ANY IMPLIED WARRANTIES OF MERCHANTABILITY, FITNESS FOR A PARTICULAR PURPOSE OR NON-INFRINGEMENT OF THIRD PARTY INTELLECTUAL PROPERTY RIGHTS.

These resources are intended for skilled developers designing with TI products. You are solely responsible for (1) selecting the appropriate TI products for your application, (2) designing, validating and testing your application, and (3) ensuring your application meets applicable standards, and any other safety, security, regulatory or other requirements.

These resources are subject to change without notice. TI grants you permission to use these resources only for development of an application that uses the TI products described in the resource. Other reproduction and display of these resources is prohibited. No license is granted to any other TI intellectual property right or to any third party intellectual property right. TI disclaims responsibility for, and you will fully indemnify TI and its representatives against, any claims, damages, costs, losses, and liabilities arising out of your use of these resources.

TI's products are provided subject to [TI's Terms of Sale](#) or other applicable terms available either on [ti.com](https://www.ti.com) or provided in conjunction with such TI products. TI's provision of these resources does not expand or otherwise alter TI's applicable warranties or warranty disclaimers for TI products.

TI objects to and rejects any additional or different terms you may have proposed.

Mailing Address: Texas Instruments, Post Office Box 655303, Dallas, Texas 75265  
Copyright © 2024, Texas Instruments Incorporated

## Looking for pricing, stock, or lifecycle information?

Click below to explore more details on WIN SOURCE:

 [View THS6062IDRG4](#) on WIN SOURCE

 [Texas Instruments](#) Information

## Optimize Your Supply Chain with WIN SOURCE Solutions

-  Global Sourcing Solution
-  Obsolete Management
-  Cost Control Management
-  Shortage Management
-  Alternative Solution
-  Excess Inventory Management