



**THE DATASHEET OF
BCM7312TKPB16G**





SINGLE-CHIP SATELLITE SET-TOP DECODER

FEATURES

- **Integrated RF Tuner**
 - Low-cost external fixed LNA chip
 - 950 - 2150 MHz RF input
 - All on-chip clocks generated from a single crystal
- **All-Digital Satellite Receiver**
 - 15 - 30 Mbaud variable rate receiver
 - Integrated 7-bit A/D converters
 - DVB/DIRECTV®/DigiCipher® II compliant FEC decoder
- **Data Transport Processor**
 - Support for DIRECTV and MPEG transport streams
 - DES/DVB descrambler
 - NDS XTV/ICAM support
 - Integrated DIRECTV AV security chip
- **MPEG-ATSC Compliant Audio/Video Decoders**
 - MP@ML MPEG2 video decoder
 - Decode of MPEG Layer 1 and Layer 2 audio
 - Support for Dolby® AC-3 and Compressed PCM
- **Broadcom® Graphics Engine (BGE)**
 - Supports multiple graphic layers
 - 2D video-scaling support
 - Integrated PAL/NTSC/SECAM encoder
- **MIPS32™ CPU Core at 266 MHz**
 - MIPS16e™ ASE code-compression support
 - MMU support
 - EJTAG debug support

SUMMARY OF BENEFITS

- Provides a very cost-effective solution for Direct Broadcast Satellite (DBS) applications.
- Ideally targeted at the low-cost, high-volume DBS boxes for cost-sensitive opportunities and emerging markets.
- Fully Integrated Tuner, QPSK Receiver, MPEG2 A/V decoder, MIPS CPU and peripherals for complete set-top box system.
 - Low-cost solution for next-generation set-top boxes.
- Advanced 2D graphics system allows applications such as Internet browsers and electronic program guides to deliver studio-quality text and graphics on television monitors.
- Subsystems are based on Broadcom's field-proven production-available technologies.
- Broadcom developed device drivers enable rapid software development cycle with support of industry-standard operation systems.
- Industry-leading third-party operating systems, tool chains and middleware supported, including OpenTV, NDS's XTV system.

BCM7312 Single-Chip System Block Diagram

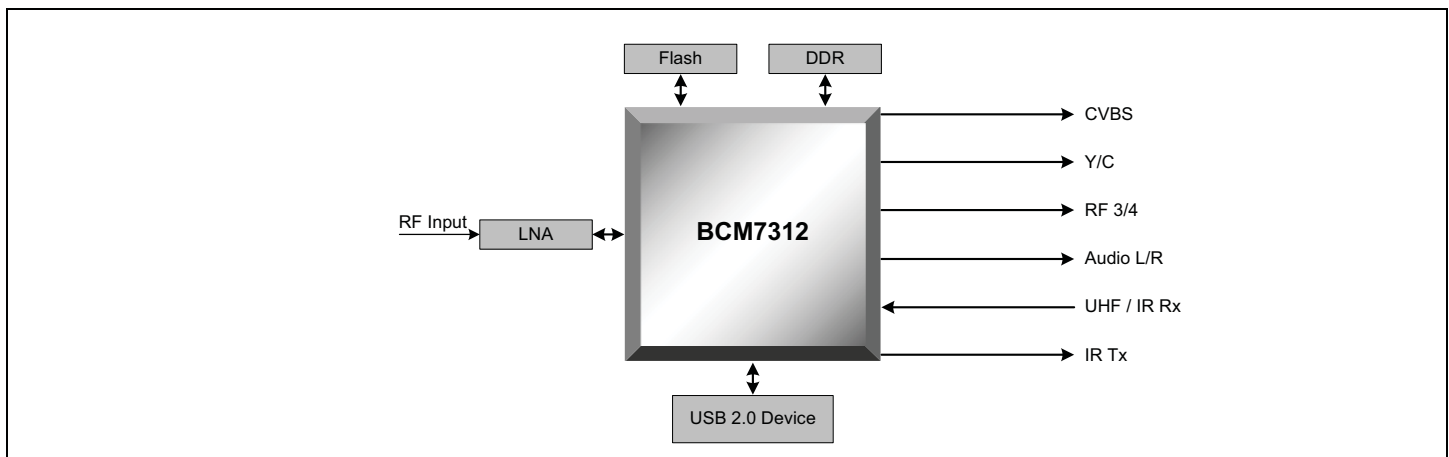

OVERVIEW

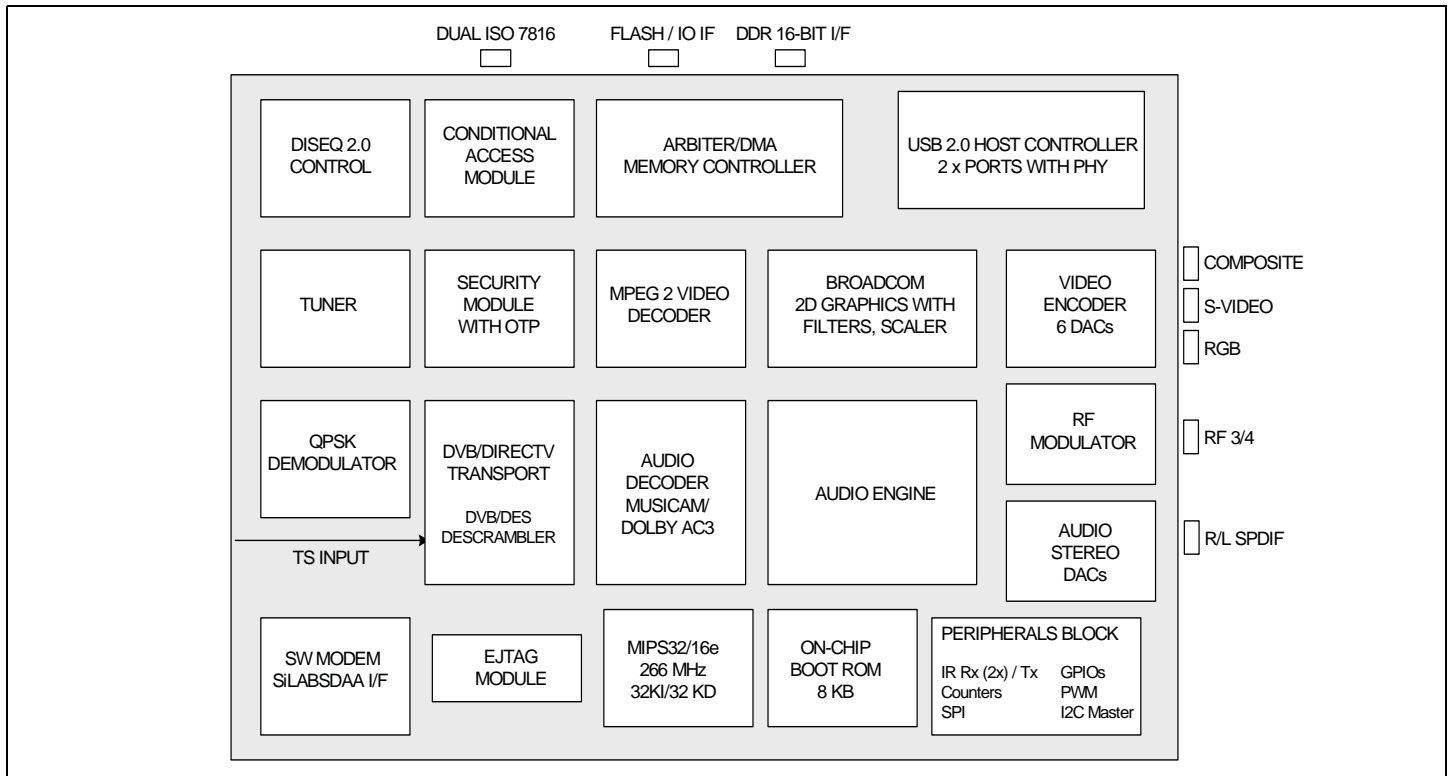

The BCM7312 is Broadcom's third-generation satellite set-top box system on a chip design, but it is the first to fully integrate the DBS Tuner. This is the first truly integrated single chip for DBS applications.

The BCM7312 integrates existing volume production technologies from Broadcom's cable, satellite, and digital TV market expertise.

The BCM7312 design is based on a unified memory architecture (UMA), utilizing a 150 MHz, 16-bit wide Double Data Rate (DDR) memory interface for added performance.

The BCM7312 offers very high levels of integration for reduced system BOM, including RF 3/4 Modulator, USB 2.0 Host + Physical I/F, Stereo Audio DACs, Video Line Drivers, VCXOs and an internal 1.3V voltage

regulator. For further cost saving, the BCM7312 integrates Silicon Labs' Si305x SSD device for SW Modem applications.

The on-chip video encoder supports NTSC, PAL, and SECAM with optional Macrovision 7.1 support.

The BCM7312 includes a complete industry standard MIPS32 microprocessor subsystem, including 32 Kbytes instruction and data caches. The CPU operates at 266 MHz, offering over 340-DMIPS rating. The architecture also includes the MIPS16e Application-Specific Extension for code compaction.

A full range of peripheral features are supported, including UARTs, dual ISO 7816 smart cards I/F, GPIO, counters/timers, IR Tx/Rx, I2C and SPI controllers.

Broadcom[®], the pulse logo, and **Connecting everything**[®] are trademarks of Broadcom Corporation and/or its subsidiaries in the United States and certain other countries. All other trademarks mentioned are the property of their respective owners.

Connecting
everything[®]



BROADCOM CORPORATION
16215 Alton Parkway, P.O. Box 57013
Irvine, California 92619-7013

© 2004 by BROADCOM CORPORATION. All rights reserved.

7312-PB03-R 12/06/04

Phone: 949-450-8700
Fax: 949-450-8710
E-mail: info@broadcom.com
Web: www.broadcom.com

Looking for pricing, stock, or lifecycle information?

Click below to explore more details on WIN SOURCE:

 [View BCM7312TKPB16G on WIN SOURCE](#)

 [Broadcom Limited](#) Information

Optimize Your Supply Chain with WIN SOURCE Solutions

-  Global Sourcing Solution
-  Obsolete Management
-  Cost Control Management
-  Shortage Management
-  Alternative Solution
-  Excess Inventory Management