

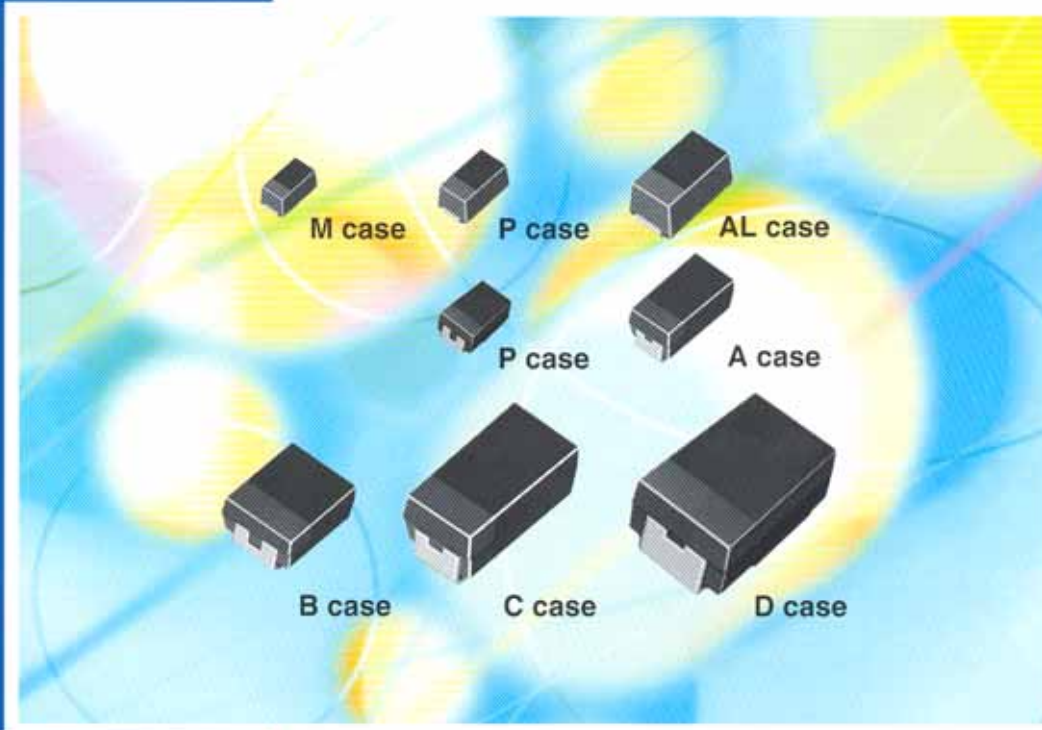

**THE DATASHEET OF
TCFGD1E476MCR**



Tantalum Capacitors



CONTENTS

TC Series P case / A case

- Standard Type

TC Series M case

TCT Series P case / AL case

- Face-down Terminal Type

TCFG Series P case / A case / B case C case / D case

- Open Function Built-in Type

TCO Series A case

- Conductive Polymer Type



Selection Guide

1 Standard Type

Conventional Line-up

TC Series P case (2012)

TC Series A case (3216)

Applications

- General electric equipment
- Mobile phone

2 Face-down Terminal Type

Only M case is supplied as TC Series.

Large capacitance
in small case · Low ESR

TC Series M case (1608)

TCT Series P case (2012)

TCT Series AL case (3216L)
t=1.2mm

Applications

- Mobile phone
- DSC
- DVC
- Applications require small and low-profile capacitors

3 Open Function Built-in Type

For safety requirement

TCFG Series P case (2012)

TCFG Series A case (3216)

TCFG Series B case (3528)

TCFG Series C case (6032)

TCFG Series D case (7343)

Applications

- PC and PC peripheral equipment
- VCR, DSC
- ITS applications for automotive
- General Business Machine (Printer, Facsimile, copy)

4 Conductive Polyer Type

Ultra low ESR

TCO Series A case

Applications

- PC and PC peripheral equipment
- Mobile phone
- DSC
- DVC

[Typ.] TC Series P case (6.3V, 10 μ F)

1 Frequency characteristics

The electric characteristics of tantalum capacitors response to the frequency of the circuits. Generally, capacitance and dissipation factor are measured at 120Hz, impedance and ESR are measured at 100kHz.

Please consider with the frequency characteristic curves when you start to design.

Frequency characteristics : dissipation factor

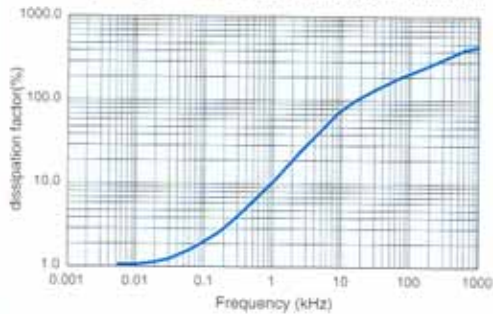

Frequency characteristics : Capacitance

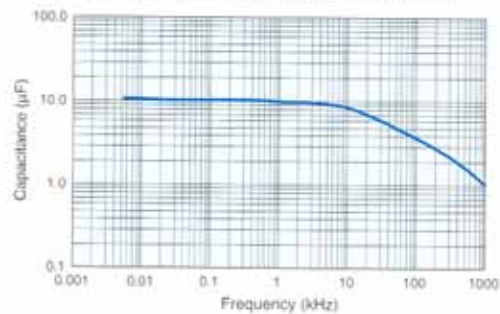

Frequency characteristics : ESR

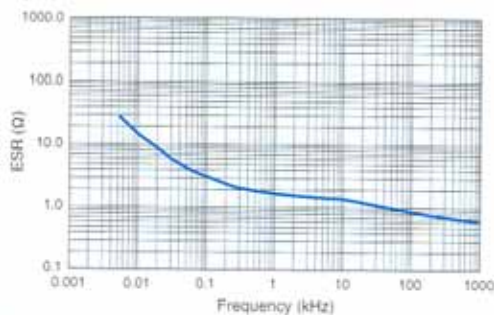

Frequency characteristics : Impedance

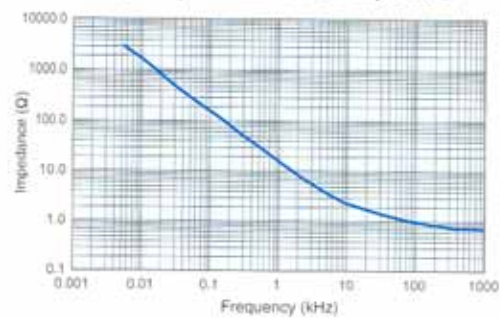

2 Temperature characteristics and DC bias characteristics

Capacitance value of tantalum capacitor is stable for the ambient temperature, and it is stable for DC bias of the circuits.

Temperature characteristics : Capacitance

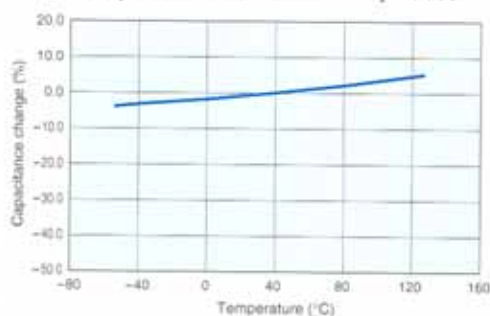

DC Bias characteristics : Capacitance

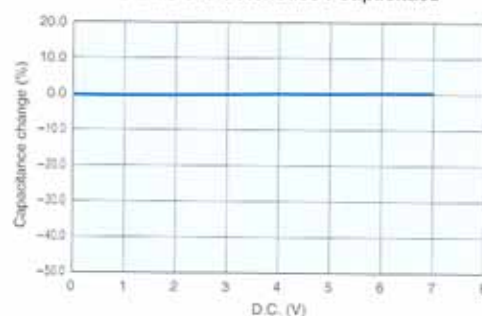

TC Series P case/A case (2012·3216)

Features

- 1) Vital for all hybrid integrated circuits board application.
- 2) Wide capacitance range.
- 3) Screening by thermal shock.

Dimensions

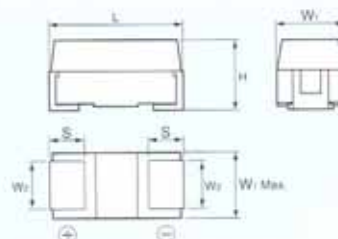

Case code	L	W ₁	W ₂	H	S
P(2012)	2.0±0.2	1.25±0.2	0.9±0.2	Max.1.20	0.45±0.3
A(3216)	3.2±0.2	1.6±0.2	1.2±0.2	1.6±0.2	0.8±0.3

(Unit:mm)

Rated Table·Marking

μF	Rated voltage (V. DC)						
	4 0G	6.3 0J	10 1A	16 1C	20 1D	25 1E	35 1V
1.0			P	P, A	P, A	P, A	A
1.5		P	P, A	P, A	A	A	
2.2	P	P	P, A	P, A	A	A	
3.3	P	P, A	P, A	P, A	A	A	
4.7	P, A	P, A	P, A	A	A		
6.8	P, A	P, A	P, A	A			
10	P, A	P, A	P, A	A			
15	P, A	P, A	A				
22	P, A	P, A	A				
33	A	A					
47	A	A					
68	A						
100	A						

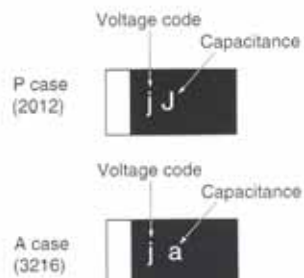

Face-down Terminal Type

TC Series M case, TCT Series P case/AL case (1608-2012-3216L)

Features

Newly designed ROHM original package structure (face-down terminal) provides,

- 1) Achieve the double capacitance value as compare with the current product.
- 2) Excellent adhesion.
- 3) Easy visual recognition of fillets.

Dimensions

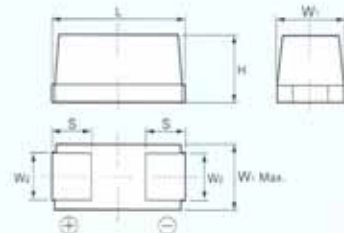

Case code	L	W ₁	W ₂	H	S
M(1608)	1.6±0.1	0.85±0.1	0.55±0.1	0.8±0.1	0.5±0.1
P(2012)	2.0±0.2	1.25±0.2	0.85±0.2	Max.1.20	0.5±0.1
AL(3216)	3.2±0.2	1.6±0.2	1.2±0.2	1.1±0.1	0.8±0.2

(Unit:mm)

Rated Table·Marking

μF	Rated voltage (V. DC)				
	4 0G	6.3 0J	10 1A	16 1C	20 1D
1			M	M	
1.5					
2.2			M		
3.3					
4.7		M	M		AL
6.8		M			
10	M	M			
15			P	AL	
22	M	P	P		
33	P	P	AL		
47	P	AL	AL		
68	AL	AL			
100	AL				

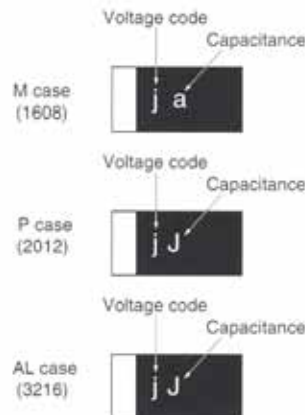

Impedance characteristics

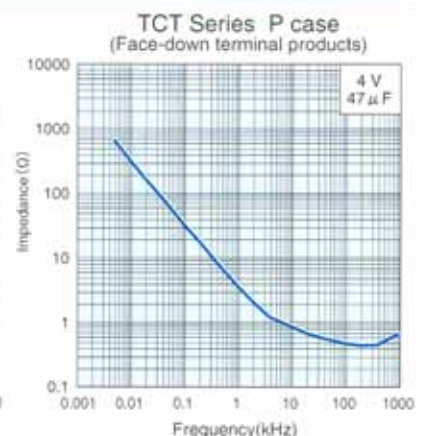
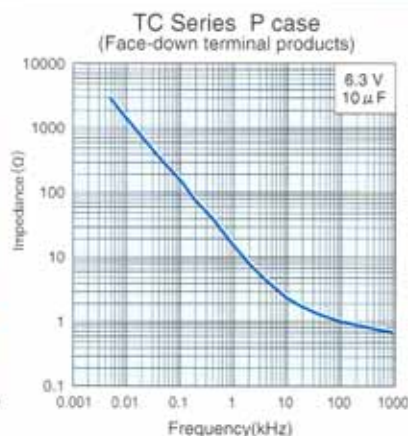
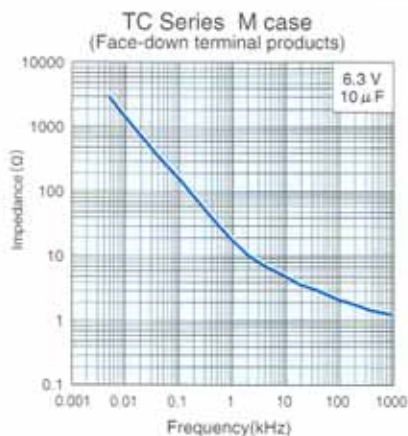



Open Function Built-in Type

TCFG Series P case/A case/B case (2012·3216·3528)

Features

- 1) Safety design by open function built-in
- 2) Wide capacitance range
- 3) Screening by thermal shock

Dimensions

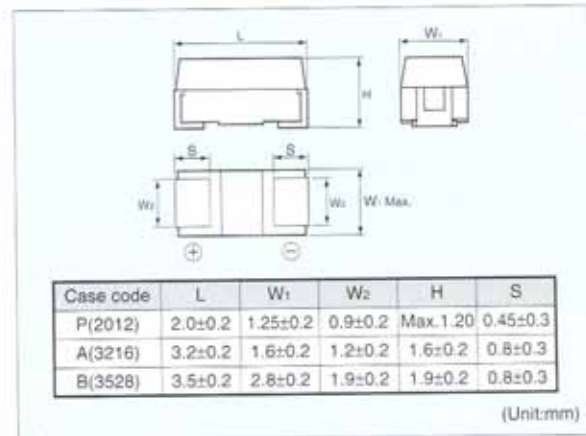

Rated Table·Marking

μF	Rated voltage (V. DC)						
	2.5 0E	4 0G	6.3 0J	10 1A	16 1C	20 1D	25 1E
1.0				P	P, A	P, A	A
1.5			P	P, A	P, A		
2.2		P	P	P, A	P, A		
3.3		P	P, A	P, A	P, A, B	B	B
4.7		P, A	P, A	P, A, B	A, B	B	
6.8		P, A	P, A	A, B	A, B	B	
10		P, A	P, A, B	A, B	A	B	
15		P, A, B	P, A, B	A, B	B		
22		P, A, B	A, B	A, B	B		
33		A, B	A, B	B			
47		A, B	A, B	B			
68		A, B	B	B			
100		B	B				
150		B					
220	B	B					

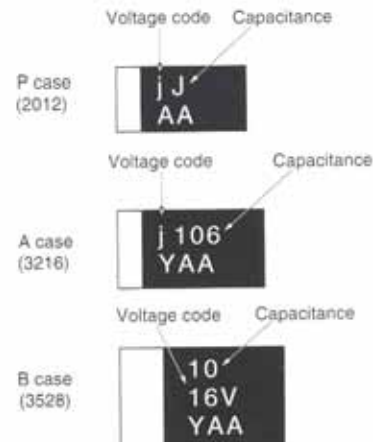

Open-function characteristic by temperature

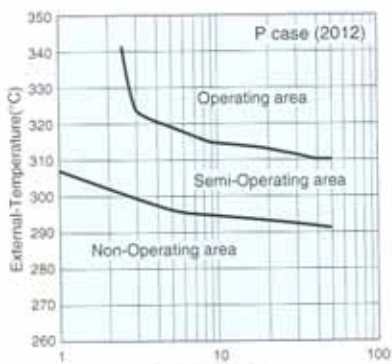

(Semi operating area: possible from open-function to operate)

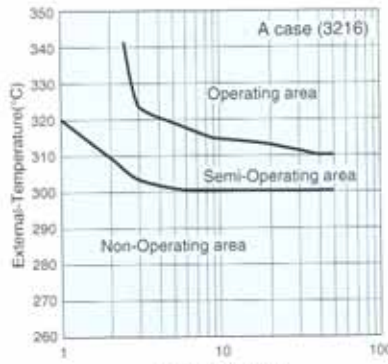

(Semi operating area: possible from open-function to operate)

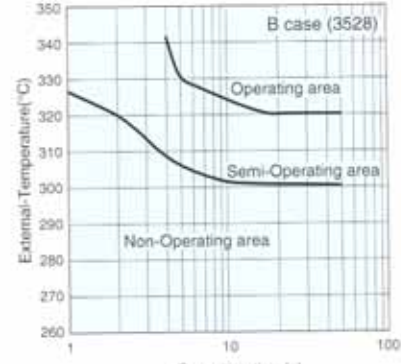

(Semi operating area: possible from open-function to operate)

TCFG Series C case/D case (6032-7347) **NEW**

Features

- 1) Safety design by open function built-in
- 2) Wide capacitance range
- 3) Screening by thermal shock

Dimensions

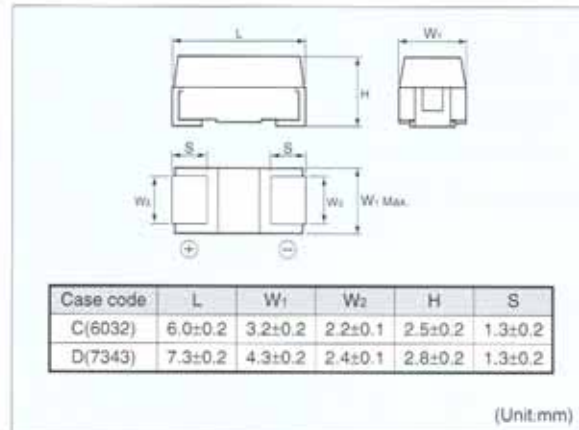

Rated Table·Marking

μF	Rated voltage (V. DC)			
	4 0G	6.3 0J	10 1A	16 1C
22				
33				C
47				C
68			C	D
100		C	C, D	D
150	C	C, D	D	
220	C, D	D		
330	D			
470				
680				

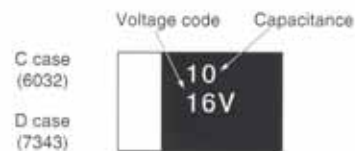

Open-function characteristic by temperature

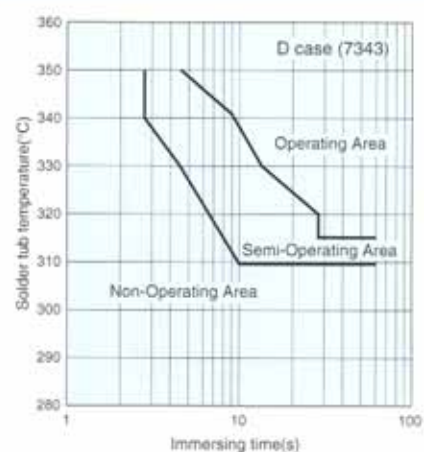
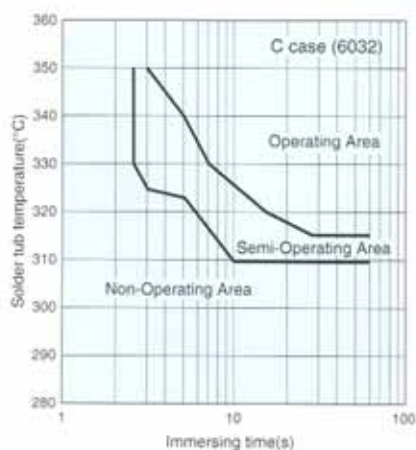



Conductive Polymer Type

TCO Series A case (3216·Low ESR)

NEW

Features

- 1) The cathode material is conductive polymer
- 2) Ultra low ESR
(1/10 : compare with the conventional product)
- 3) Screening by thermal shock

Dimensions

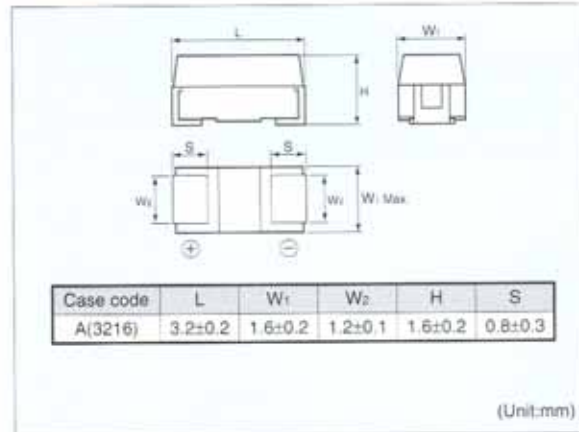

Rated Table·Marking

μF	Rated voltage (V. DC)			
	2.5 0E	4 0G	6.3 0J	10 1A
3.3				
4.7				A
6.8			A	A
10		A	A	A
15	A	A	A	
22	A	A	A	
33	A	A		
47	A			
68				

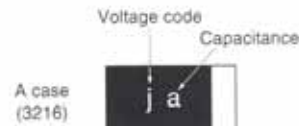

Electrical characteristics data

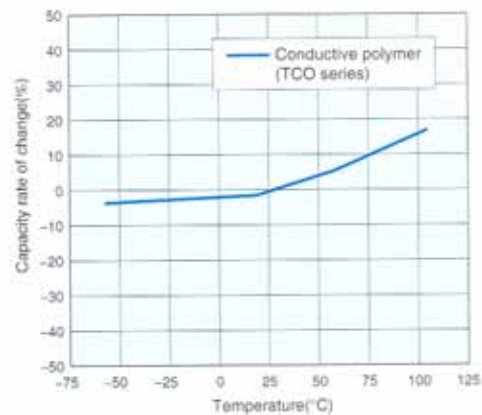
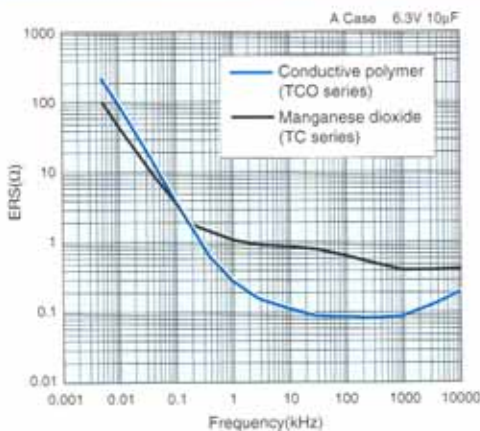

Specification

	TC/TCT/TCFG Series	TCO Series
Operating Temperature Range	-55°C through + 125°C Operation (125°C with voltage derating)	-55°C through + 105°C Operation (105°C with voltage derating)
Capacitance Tolerance	±20%(M) , ±10%(K)	±20%(M)
Dissipation Factor	Refer to the individual spec.	Refer to the individual spec.
Leakage Current	0.5μA(25°C 1min) or 0.01CV whichever is greater	5μA(25°C 5min) or 0.1CV whichever is greater
Temperature Cycle	-55°C to + 125°C 5cycle	-55°C to + 105°C 5cycle
Resistance to Soldering Heat	260°C 5s dipped	240°C 10s dipped
Surge Voltage	As follows JIS spec.	As follows JIS spec.

Model name configuration

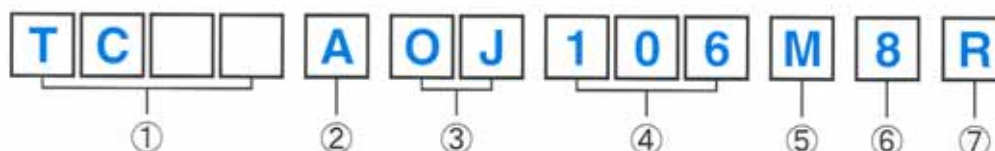

① Series name

TC/TCT/TCFG/TCO

② Case code

TCM, P, A
 TCTP, AL
 TCFGP, A, B, C, D
 TCOA

③ Rated voltage

Rated voltage(V)	2.5	4	6.3	10	16	20	25
CODE	0E	0G	0J	1A	1C	1D	1E

④ Capacitance

pF Code : 1st two digits represent significant figures, 3rd digit represent multiplier
(number of zeros to follow)

$$155 = 15 \times 10^5 \text{pF} = 1.5 \times 10^6 \text{pF} = 1.5 \mu\text{F}$$

⑤ Capacitance Tolerance

M : ±20% K : ±10%

⑥ Tape Width

B : Tape width (8mm) M, P, A, AL, B
 C : Tape width (12mm) C, D

⑦ Taping Direction

R : Anode is on the opposite side of the sprocket hole

Precautions

- 1 Verifications and confirmation of performance characteristics of products, after on-board mounting, is advised.
- 2 In particular, if a transient load (a large amount of load applied in a short period of time, such as pulse) is applied, confirmation of performance characteristics after on-board mounting is strongly recommended. Avoid applying power exceeding normal rated power; exceeding the power rating under steady-state loading condition may negatively affect product performance and reliability.
- 3 Allowable ripple voltage
 The sum of the peak values of DC and AC voltage should not exceed the rated voltage.
 The ripple voltage, if applied, should be the values in the figure below. However, the allowable ripple voltage at a high temperature should be calculated using the equation below.

$$E = \text{Allowable ripple voltage}$$

$$E \text{ Max. (at } 50^{\circ}\text{C)} = 0.7 \times E \text{ Max. (at } 25^{\circ}\text{C)}$$

$$E \text{ Max. (at } 85^{\circ}\text{C)} = 0.5 \times E \text{ Max. (at } 25^{\circ}\text{C)}$$

$$E \text{ Max. (at } 125^{\circ}\text{C)} = 0.7 \times E \text{ Max. (at } 25^{\circ}\text{C)}$$

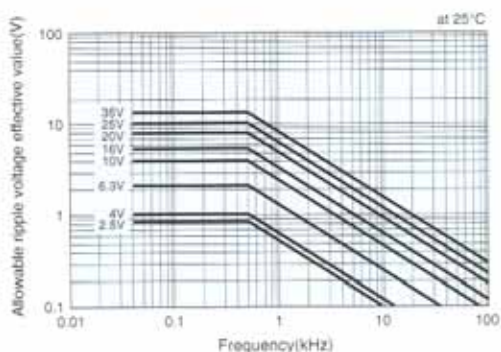

- 4 The voltage reduction should be as large as possible. Especially, a voltage lower than 1/3 of the rated voltage is recommended when used in low impedance circuit.
- 5 Tester must not be contacted with a capacitor. If it is done, an excessive or reverse voltage may be applied to the capacitor.
- 6 +85 to +125°C: with voltage derating.
- 7 Apply the series-resistor 3Ω per 1V.
- 8 When a highly active halogenous (chlorine, bromine, etc.) flux is used, the remainder of flux may negatively affect product performance and reliability. Use the flux with no halogenous.
- 9 In principle, the reflow soldering method must be used; if flow soldering method is preferred, please consult with the Company in advance.
 And in case of ultrasonic cleaning, please consult with the Company.

For basic guidelines on using chip tantalum capacitors, see the technical reports issued by Japan Electronic and Information Technology Industries Association.

JEITA RCR-2368B :Guideline of notabilia for fixed tantalum electrolytic capacitors with solid electrolyte for use in electronic equipment (Safety Application Guide for fixed tantalum electrolytic capacitors with solid electrolyte for use in electronic equipment)

Packaging Specifications

Taping Reel and Packaging Quantity

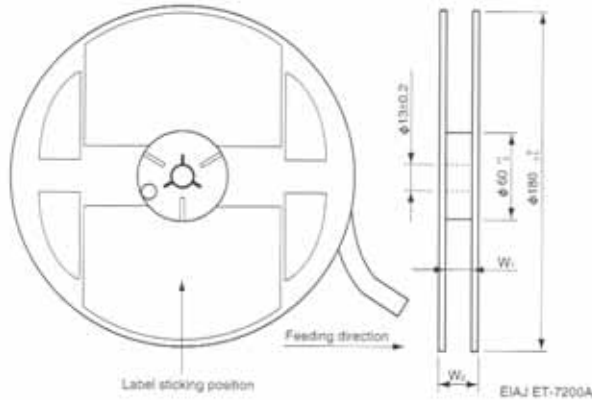

Case size	Quantity (pcs)	Tape width ±0.3 (mm)	Reel ϕ $_{-1.0}^0$ (mm)	W_1 $_{+1.0}^0$ (mm)	W_2 $_{\pm 1.0}$ (mm)
M	4000	8.0	$\phi 180$	9.0	11.4
P	3000				
AL	2000				
A	2000	12.0	$\phi 180$	13.0	15.4
B					
C	500				
D					

Embossed Carrier Tape

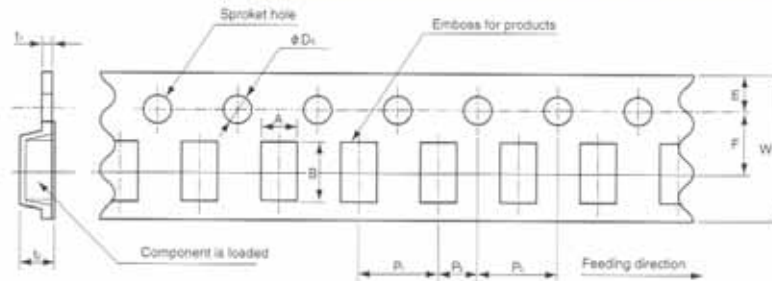

(Unit:mm)

Case size	$A \pm 0.2$	$B \pm 0.2$	$W \pm 0.3$	$E \pm 0.1$	$F \pm 0.1$	$P_1 \pm 0.1$	$P_2 \pm 0.1$	$P_3 \pm 0.1$	$D_1 \pm 0.1$	$t_1 \pm 0.1$	$t_2 \pm 0.2$
M	1.0	1.85	8.0	1.75	3.5	4.0	2.0	4.0	$\phi 1.5$	0.20	1.0
P	1.55	2.3									1.5
AL	1.9	3.5									1.3
A	3.3	3.8	12.0	5.5	8.0	0.25	1.9	2.2	3.0	3.3	
B											
C	3.7	6.4									
D	4.8	7.7									

Design example of Land patten

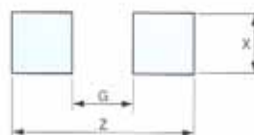

(Unit:mm)

Series	Case size	X	G	Z
TC TCFG TCO	M	0.65	0.65	2.2
	P	1.1	0.8	3.4
	A	1.4	1.2	5.2
	B	2.7	1.4	5.6
	C	2.7	2.9	6.9
TCT	D	2.9	4.1	8.2
	P	0.95	1.1	2.9
	AL	1.25	1.7	4.1

●The contents described herein are correct as of Oct, 2004.

●ROHM assumes no responsibility for the use of any circuits described herein, conveys no license under any patent or other right, and makes no representations that the circuits are free from patent infringement. Specifications subject to change without notice for the purpose of improvement.

The products listed in this catalog are designed to be used with ordinary electronic equipment or devices (such as audio visual equipment, office-automation equipment, communications devices, electrical appliances and electronic toys). Should you intend to use these products with equipment or devices which require an extremely high level of reliability and the malfunction of which would directly endanger human life (such as medical instruments, transportation equipment, aerospace machinery, nuclear-reactor controllers, fuel controllers and other safety devices), please be sure to consult with our sales representative in advance.

Excellence in Electronics

ROHM

ROHM CO., LTD.

21, Saini Mizosaki-cho, Ukyo-ku, Kyoto
615-8585, Japan
TEL: (075)311-2121 FAX: (075)315-0172
URL: <http://www.rohm.com>

Contact us for further information about the products.

Atlanta U.S.A. / ROHM ELECTRONICS ATLANTA SALES OFFICE
(DIVISION OF ROHM ELE.U.S.A.,LLC)
TEL: +1(770)754-8972 FAX: +1(770)754-0991

Dallas U.S.A. / ROHM ELECTRONICS DALLAS SALES OFFICE
(DIVISION OF ROHM ELE.U.S.A.,LLC)
TEL: +1(972)312-8819 FAX: +1(972)312-0330

San Diego U.S.A. / ROHM ELECTRONICS SAN DIEGO SALES OFFICE
(DIVISION OF ROHM ELE.U.S.A.,LLC)
TEL: +1(619)625-3630 FAX: +1(619)625-3670

Germany / ROHM ELECTRONICS GMBH (GERMANY)
TEL: +49(2154)9210 FAX: +49(2154)921400

United Kingdom / ROHM ELECTRONICS GMBH (UK)
TEL: +44(0)1908-306700 FAX: +44(0)1908-235788

France / ROHM ELECTRONICS GMBH (FRANCE)
TEL: +33(1)41 23 14 00 FAX: +33(1)41 23 14 30

Hong Kong China / ROHM ELECTRONICS (H.K.) CO., LTD.
TEL: +852(2740)6292 FAX: +852(2740)6871

Shanghai China / ROHM ELECTRONICS (SHANGHAI) CO., LTD.
TEL: +86(21)6279-2727 FAX: +86(21)6247-2096

Dalian China / ROHM ELECTRONICS TRADING (DALIAN) CO., LTD.
TEL: +86(411)8230-8549 FAX: +86(411)8230-8537

Beijing China / BEIJING REPRESENTATIVE OFFICE
TEL: +86(10)8525-2483 FAX: +86(10)8525-2489

Taiwan / ROHM ELECTRONICS TAIWAN CO., LTD.
TEL: +886(2)2520-6956 FAX: +886(2)2520-2889

Korea / ROHM ELECTRONICS KOREA CORPORATION
TEL: +82(2)6182-7000 FAX: +82(2)6182-7115

Singapore / ROHM ELECTRONICS ASIA PTE.LTD. (RES/RE)
TEL: +65-6332-2522 FAX: +65-6332-6662



Malaysia / ROHM ELECTRONICS (MALAYSIA) SDN. BHD.
TEL: +603(7958-8395 FAX: +603(7958-8377

Philippines / ROHM ELECTRONICS (PHILIPPINES) SALES CORPORATION
TEL: +63(2)807-4872 FAX: +63(2)809-1422

Thailand / ROHM ELECTRONICS (THAILAND) CO., LTD.
TEL: +66(2)254-4890 FAX: +66(2)256-6304

Looking for pricing, stock, or lifecycle information?

Click below to explore more details on WIN SOURCE:

-  [View TCFGD1E476MCR on WIN SOURCE](#)
-  [Rohm Semiconductor Information](#)

Optimize Your Supply Chain with WIN SOURCE Solutions

-  Global Sourcing Solution
-  Obsolete Management
-  Cost Control Management
-  Shortage Management
-  Alternative Solution
-  Excess Inventory Management