



**THE DATASHEET OF  
TCD-17-282X+**





# Directional Coupler

## TCD-17-282X+

50Ω

5 to 2850 MHz

### THE BIG DEAL

- Wideband, 5 to 2850 MHz
- Low mainline loss, 1.9 dB typ. up to 2850 MHz
- Aqueous washable
- Leads for excellent solderability
- Protected by US Patent 6,140,887

### APPLICATIONS

- VHF/UHF
- PCS
- ISM
- PCN
- Cellular
- UMTS
- GPS



Generic photo used for illustration purposes only

CASE STYLE: DB1627

### +RoHS Compliant

The +Suffix identifies RoHS Compliance. See our website for methodologies and qualifications

### PRODUCT OVERVIEW

Mini-Circuits' TCD-17-282X+ surface mount directional coupler provides 17 dB nominal coupling with excellent flatness from 5 to 2850 MHz, supporting a wide variety of applications including VHF/UHF, CATV, cellular, SatCom and more. This model provides low mainline loss, high directivity and excellent return loss. The coupler is built with core and wire construction mounted on a 6-lead plastic base (0.16 x 0.15 x 0.16") and includes Mini-Circuits' TopHat® feature for faster, more accurate pick-and-place assembly.

### KEY FEATURES

Feature	Advantages
Low mainline loss • 0.7 dB to 950 MHz • 1.9 dB to 2850 MHz	Provides good through-path signal power transmission.
High directivity, 10 – 25 dB	High directivity allows accurate signal sampling through the coupled port with minimal measurement error.
Excellent return loss, 14 – 22 dB (input/output/coupling)	Provides excellent matching for 50Ω systems and minimal signal reflection.
Good power handling • 1W, 100 to 2850 MHz • 0.5W, 5 to 100 MHz	Usable in systems with a variety of high-power requirements.
Top Hat® feature	Improves speed and accuracy of pick and place assembly and provides clear device marking for visual inspection.



### ELECTRICAL SPECIFICATIONS AT 25°C

Parameter	Frequency (MHz)	Min.	Typ.	Max.	Unit
Frequency Range	—	5	—	2850	MHz
Mainline Loss <sup>1</sup> (above theoretical 0.1 dB)	5	—	0.7	1.3	dB
	950	—	0.7	1.1	
	2850	—	1.9	2.4	
Coupling	5-2850	—	17±1	—	dB
Coupling Flatness (±)	5-950	—	0.3	0.6	dB
	950-2850	—	1.2	1.5	
Directivity	5-100	18	25	—	dB
	100-950	13	20	—	
	2950-850	6	10	—	
Return Loss (Input)	5	—	20	—	dB
	950	—	17	—	
	2850	—	14	—	
Return Loss (Output)	5	—	22	—	dB
	950	—	18	—	
	2850	—	14	—	
Return Loss (Coupling)	5	—	20	—	dB
	950	—	16	—	
	2850	—	15	—	
Input Power	5-100	—	—	0.5	W
	100-2850	—	—	1.0	

1. Mainline loss includes theoretical power loss at coupled port.

### MAXIMUM RATINGS

Parameter	Ratings
Operating Temperature	-40°C to 85°C*
Storage Temperature	-55°C to 100°C

Permanent damage may occur if any of these limits are exceeded.

\* Case temperature is defined as temperature on ground leads.

### ELECTRICAL SCHEMATIC

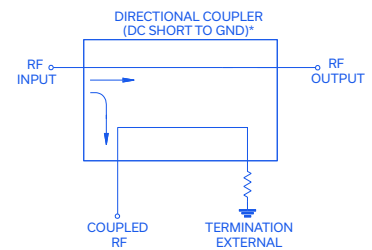

\*Electrical schematic is for Directional coupler with internal transformer(s) and external termination



# Directional Coupler

**TCD-17-282X+**

**PIN CONNECTIONS**

INPUT	3
OUTPUT	4
COUPLED	1
GROUND	2
50Ω TERM EXTERNAL	6
NOT USED	5

**PRODUCT MARKING:** DF

**DEMO BOARD MCL P/N:** TB-71  
**SUGGESTED PCB LAYOUT (PL-009)**

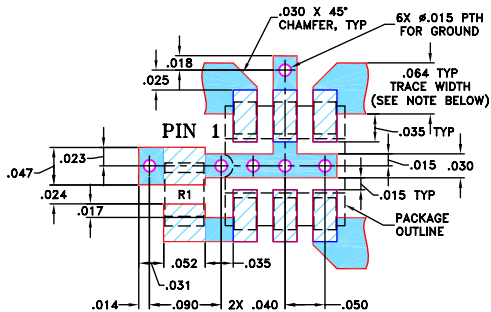

RESISTOR R1: 49.9 ± 1% Ohm, 0805 SIZE

**NOTES:** 1. TRACE WIDTH IS SHOWN FOR ROGERS RO4350B WITH DIELECTRIC THICKNESS 0.030" ± 0.002"; COPPER: 1/2 OZ. EACH SIDE. FOR OTHER MATERIALS TRACE WIDTH MAY NEED TO BE MODIFIED.  
 2. BOTTOM SIDE OF THE PCB IS CONTINUOUS GROUND PLANE.

- DENOTES PCB COPPER LAYOUT WITH SMOBC (SOLDER MASK OVER BARE COPPER)
- DENOTES COPPER LAND PATTERN FREE OF SOLDER MASK

**OUTLINE DRAWING**

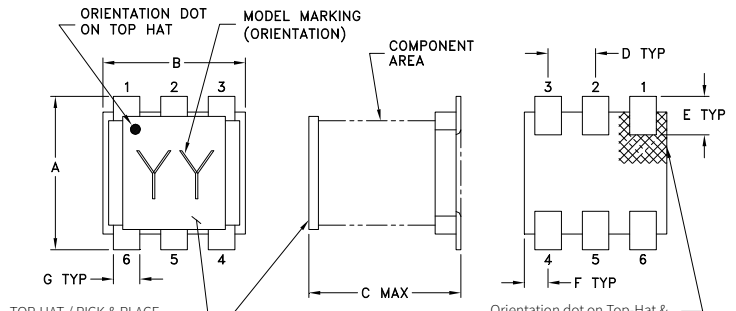

TOP-HAT / PICK & PLACE SURFACE AREA (10X10) MIN  
 TOP-HAT TOTAL THICKNESS: .013 inches MAX.

Orientation dot on Top-Hat & orientation feature on substrate corresponds to pin #1.

**PCB Land Pattern**

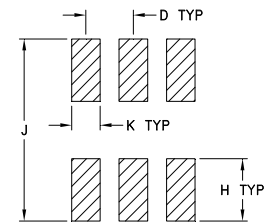

**SUGGESTED LAYOUT**  
 TOLERANCE TO BE WITHIN ±.002

**OUTLINE DIMENSIONS (Inches mm)**

A	B	C	D	E	F
.160	.150	.160	.050	.040	.025
4.06	3.81	4.06	1.27	1.02	0.64
G	H	J	K		wt
.028	.065	.190	.030		grams
0.71	1.65	4.83	0.76		0.15

**TAPE & REEL INFORMATION: F47**



# Directional Coupler

**TCD-17-282X+**

**TYPICAL PERFORMANCE DATA**

Frequency (MHz)	Mainline Loss (dB)		Coupling (dB)	Directivity (dB)	Return Loss (dB)		
	In-Out	In-Cpl			In	Out	Cpl
5	0.62	17.63	32.71	22.72	25.10	22.92	
50	0.60	17.61	38.38	24.47	27.28	24.42	
350	0.66	17.71	30.67	21.79	22.63	21.28	
650	0.77	17.79	22.79	18.79	19.05	18.33	
950	0.90	17.87	17.87	16.99	17.11	16.63	
1250	1.03	17.77	14.58	15.90	16.01	15.81	
1650	1.20	17.28	11.83	15.31	15.14	15.57	
2050	1.40	16.52	10.09	15.38	14.70	16.04	
2450	1.63	15.79	8.93	16.19	14.74	17.16	
2850	1.93	15.27	8.21	17.12	14.89	18.94	

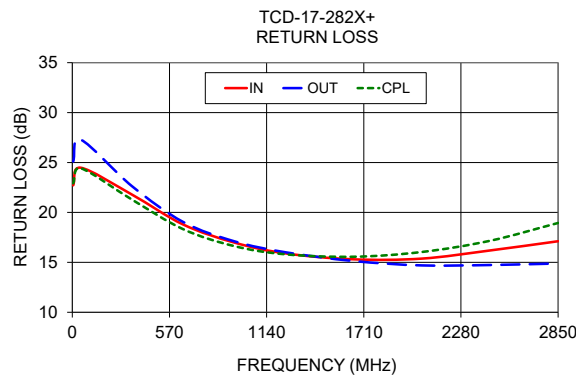
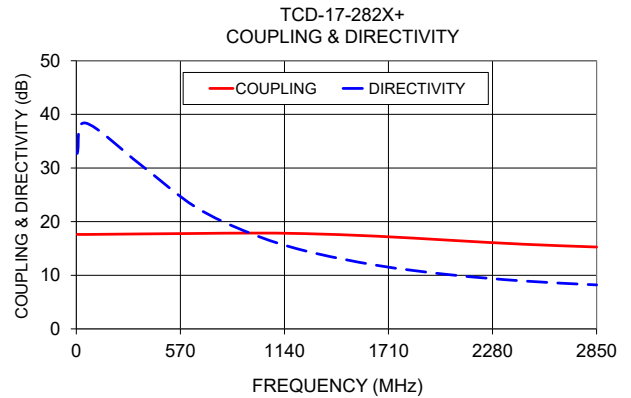
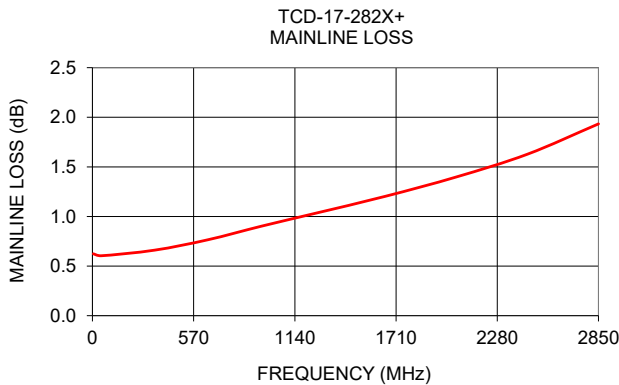

- NOTES**
- A. Performance and quality attributes and conditions not expressly stated in this specification document are intended to be excluded and do not form a part of this specification document.
  - B. Electrical specifications and performance data contained in this specification document are based on Mini-Circuit's applicable established test performance criteria and measurement instructions.
  - C. The parts covered by this specification document are subject to Mini-Circuits standard limited warranty and terms and conditions (collectively, "Standard Terms"); Purchasers of this part are entitled to the rights and benefits contained therein. For a full statement of the standard. Terms and the exclusive rights and remedies thereunder, please visit Mini-Circuits' website at [www.minicircuits.com/terms/viewterm.html](http://www.minicircuits.com/terms/viewterm.html)

## Looking for pricing, stock, or lifecycle information?

Click below to explore more details on WIN SOURCE:

 [View TCD-17-282X+ on WIN SOURCE](#)

 [Mini-Circuits Information](#)

## Optimize Your Supply Chain with WIN SOURCE Solutions

-  Global Sourcing Solution
-  Obsolete Management
-  Cost Control Management
-  Shortage Management
-  Alternative Solution
-  Excess Inventory Management