

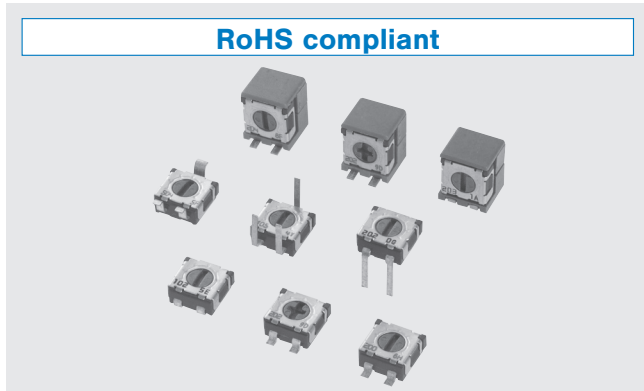

THE DATASHEET OF ST4ETA504



SURFACE MOUNT CERMET TRIMMERS (SINGLE TURN) **ST-4**



FEATURES

- RoHS compliant
- Wide variety (7 types) to choose from
- Automatic mounting is possible (Taping)
- Flow/reflow soldering is possible
- Sealed construction (Washable: Refer to page 628.)
- Stopper structure prevents terminal pin from being open
- Cross slot rotor suitable for automatic adjustment
- Resin materials are UL Recognized 94V-0 or 94V-1 equivalent

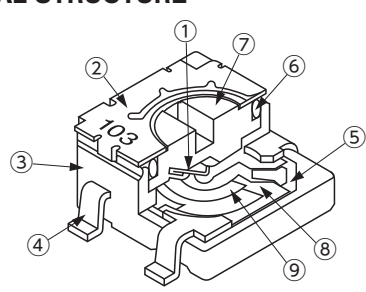
INTERNAL STRUCTURE	
	
Part name	Material
① Wiper	Multi metal alloy
② Cover	Stainless steel (SUS 304)
③ Housing	Epoxy
④ Terminal pin	Copper alloy, Sn-Cu-plated
⑤ Base element	Ceramic
⑥ "O" ring	Silicone rubber
⑦ Rotor	PPS (Polyphenylenesulphide)
⑧ Electrode	Ag-Pd cermet
⑨ Resistive element	RuO ₂ cermet

PART NUMBER DESIGNATION

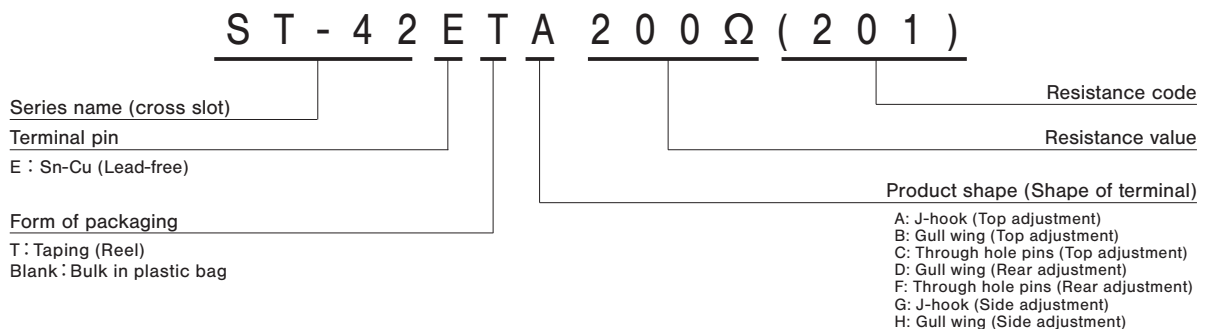
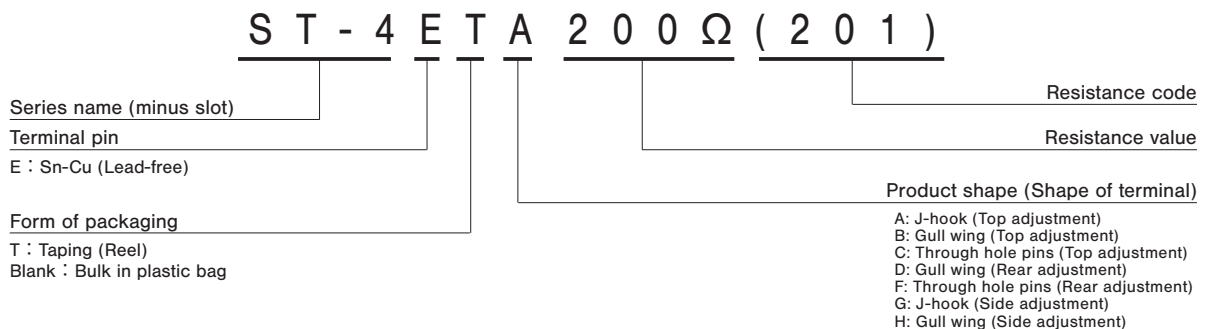

※ Please refer to the LIST OF PART NUMBERS when placing orders.

ST-4

SURFACE MOUNT TRIMMERS

LIST OF PART NUMBERS

Adjustment position	Shape of terminal	Form of packaging	
		Taping (reel)	Plastic bag
Top adjustment	A (J-hook)	ST-4/42ETA	ST-4/42EA
	B (Gull wing)	ST-4/42ETB	ST-4/42EB
	C (Through hole pins)		ST-4/42EC
Rear adjustment	D (Gull wing)	⊖ ST-4/42ETD	⊖ ST-4/42ED
	F (Through hole pins)		⊖ ST-4/42EF
Side adjustment	G (J-hook)	ST-4/42ETG	ST-4/42EG
	H (Gull wing)	ST-4/42ETH	ST-4/42EH
Pieces in package		500 pcs./reel	100 pcs./pack

The products indicated by ⊖ mark are manufactured upon receipt of order basis.

※ ⊖ slot : ST-4E□, ⊕ slot : ST-42E□

ELECTRICAL CHARACTERISTICS

Nominal resistance range	10 Ω ~ 2 MΩ
Resistance tolerance	± 20 %
Power ratings	0.25 W (70 °C) 0 W (125 °C)
Resistance law	Linear law (B)
Maximum input voltage	DC200 V or power rating, whichever is smaller
Maximum wiper current	100 mA or power rating, whichever is smaller
Effective electrical angle	210° (1 turn)
End resistance	1 % or 2 Ω, whichever is greater
C.R.V.	1 % or 3 Ω, whichever is greater
Operating temp. range	- 55 ~ 125 °C
Temp. coefficient	10 Ω ~ 50 Ω : ± 250 10 ⁻⁶ /°C maximum 100 Ω ~ 2 MΩ : ± 100 10 ⁻⁶ /°C maximum
Insulation resistance	1000 MΩ minimum (DC500 V)
Dielectric strength	AC500 V, 60 s
Net weight	Approx. 0.12 g (ST-4EA, EB, EC, ED, EF) Approx. 0.22 g (ST-4EG, EH)

Reflow profile for soldering heat evaluation

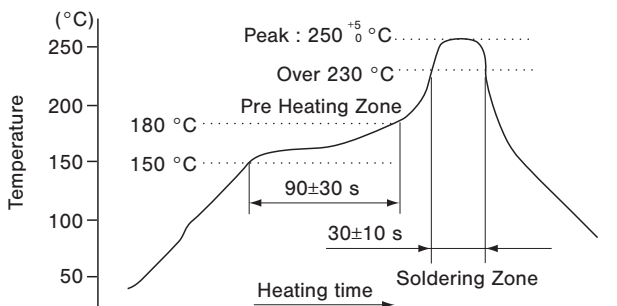

Reflow : two times maximum

Nominal resistance values

⊖10 Ω	⊖20 Ω	50 Ω	100 Ω	200 Ω	500 Ω	1 kΩ	2 kΩ	5 kΩ
10 kΩ	20 kΩ	50kΩ	100 kΩ	200 kΩ	500 kΩ	1 MΩ	2 MΩ	

Fig. 1

☐ : Not manufactured

※ The above part numbers are all available with the respective combination of <Nominal resistance values> (Fig. 1).

※ Verify the above part numbers when placing orders.

※ Taping specification is not sold separately and must be purchased in reel units.

※ Cross slot available : ST-42E □

MECHANICAL CHARACTERISTICS

Mechanical angle	240° (1 turn)
Operating torque	10 mN-m {102 gf-cm} maximum
Stop strength	30 mN-m {306 gf-cm} minimum
Rotational life	100 cycles [Δ R/R ≤ ± (2 Ω + 3 %)]
Thrust to rotor	5 N {0.51 kgf} minimum
Solderability	245 ± 3 °C, 2 ~ 3 s
Shear (Adhesion)	5 N {0.51 kgf} 10 s
Substrate bending	Width 90 mm, bend 3 mm, 5 s, 1 time
Pull-off strength	5 N {0.51 kgf} 10 s

{ } : Reference only

ENVIRONMENTAL CHARACTERISTICS

Test item	Test conditions	Specifications
Thermal shock	- 65 ~ 125 °C (0.5 h), 5 cycles	[Δ R/R ≤ 2 %] [S.S. ≤ 1 %]
Humidity	- 10 ~ 65 °C (Relative humidity 80 ~ 98 %), 10 cycles, 240 h	[Δ R/R ≤ 2 %]
Shock	981 m/s ² , 6 ms 6 directions for 3 times each	[Δ R/R ≤ 1 %] [S.S. ≤ 1 %]
Vibration	Amplitude 1.52 mm or Acceleration 196 m/s ² , 10 ~ 2000 Hz, 3 directions, 12 times each	[Δ R/R ≤ 1 %] [S.S. ≤ 1 %]
Load life	70 °C, 0.25 W 1000 h	[Δ R/R ≤ 3 %] [S.S. ≤ 1 %]
Low temp. operation	- 55 °C, 2 h	[Δ R/R ≤ 2 %] [S.S. ≤ 2 %]
High temp. exposure	125 °C, 250 h	[Δ R/R ≤ 3 %] [S.S. ≤ 2 %]
Immersion seal	85 °C, 60 s	No leaks (No continuous bubbles)
Soldering heat	Flow: 260±3°C as the temperature in a pot of molten solder, immersion from head of terminal to backside of board, 5~6 s, two times maximum Reflow : Peak temperature 255 °C (Please refer to the profile below.) Manual soldering: 350 ± 10 °C, 3 ~ 4 s	[Δ R/R ≤ 1 %]

Δ R/R : Change in total resistance
S.S. : Setting stability

ST-4

SURFACE MOUNT TRIMMERS

MAXIMUM INPUT RATINGS

Nominal resistance values (Ω)	Resistance code	Maximum input voltage (V)	Maximum wiper current (mA)
⊕ 10	100	1.00	100
⊕ 20	200	2.00	100
50	500	3.53	70.7
100	101	5.00	50.0
200	201	7.07	35.4
500	501	11.2	22.4
1 k	102	15.8	15.8
2 k	202	22.4	11.2
5 k	502	35.4	7.07
10 k	103	50.0	5.00
20 k	203	70.7	3.54
50 k	503	112	2.24
100 k	104	158	1.58
200 k	204	200	1.00
500 k	504	200	0.40
1 M	105	200	0.20
2 M	205	200	0.10

The products indicated by ⊕ mark are manufactured upon receipt of order basis.

RECOMMENDED P.C.B. PAD OUTLINE DIMENSIONS

(Unit: mm)

ST-4EA

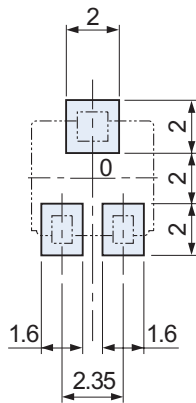

ST-4EB

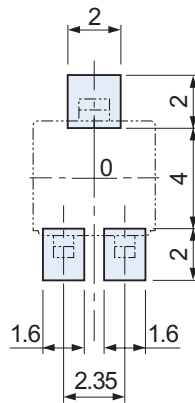

ST-4ED

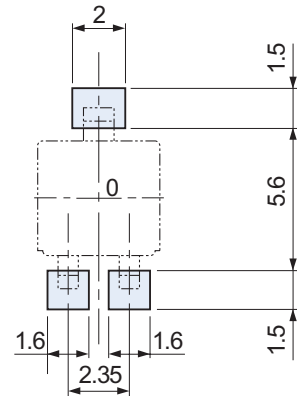

ST-4EG

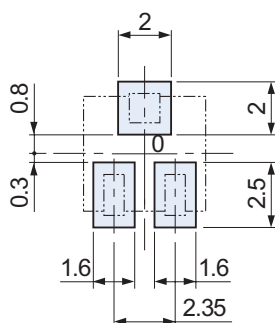

ST-4EH

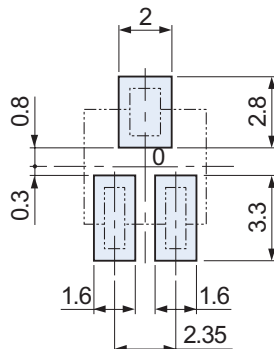

(Note) The zero point is the center of mounting.

ST-4

SURFACE MOUNT TRIMMERS

OUTLINE DIMENSIONS

Unless otherwise specified, tolerance : ± 0.3 (Unit: mm)

ST-4EA Top adjustment

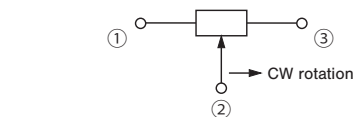
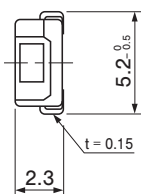
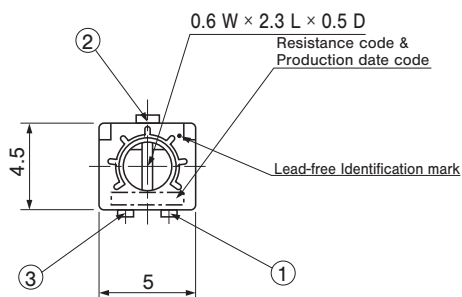

※ Note the terminal position.

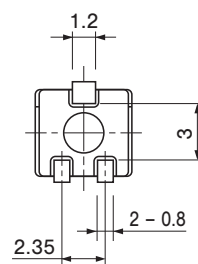

ST-4EB Top adjustment

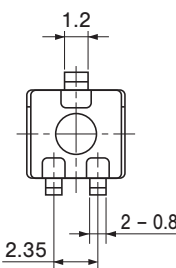
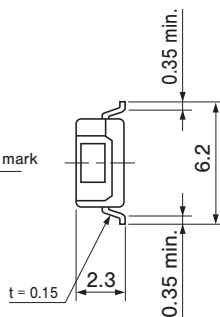
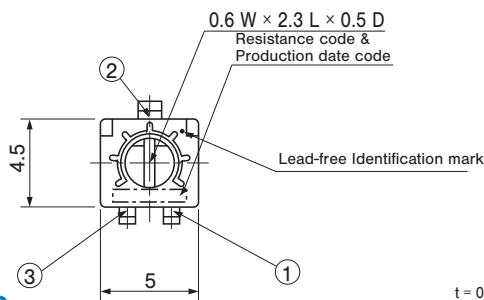

ST-4EC Top adjustment

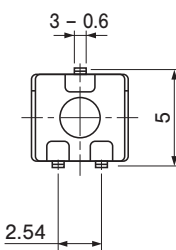
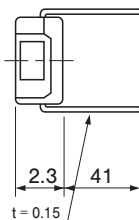
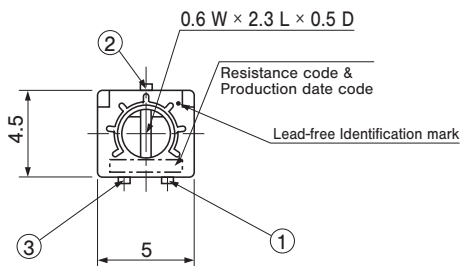

ST-4EG Side adjustment

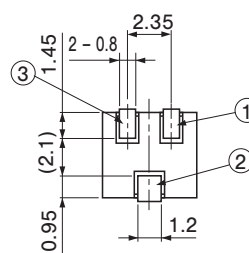
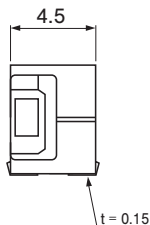
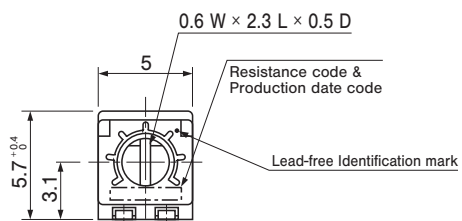

ST-4

SURFACE MOUNT TRIMMERS

OUTLINE DIMENSIONS

Unless otherwise specified, tolerance : ± 0.3 (Unit: mm)

ST-4EH Side adjustment

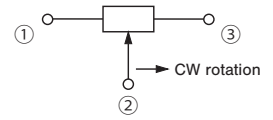

※ Note the terminal position.

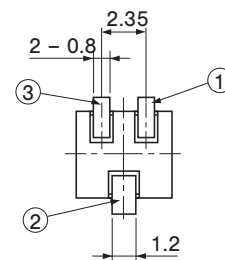
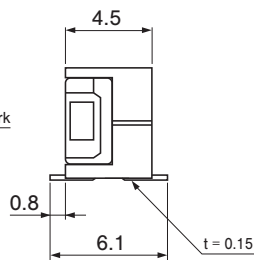
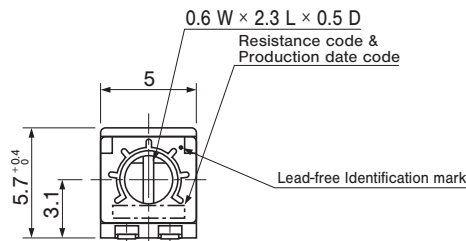

< Semi-standard products >

ST-4ED Rear adjustment

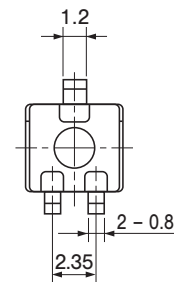
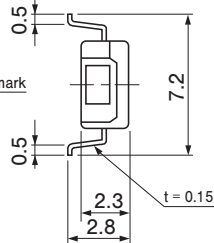
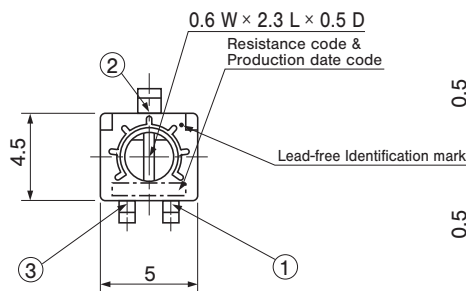

< Semi-standard products >

ST-4EF Rear adjustment

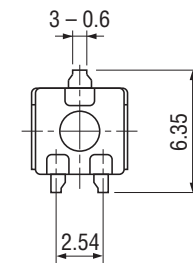
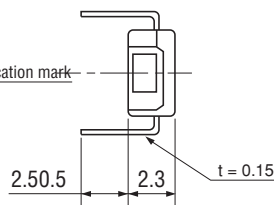
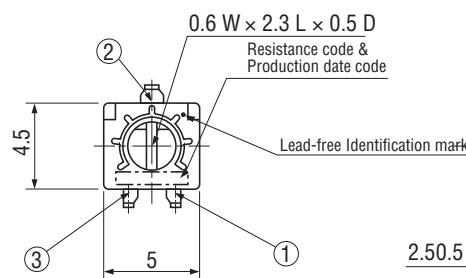

ST-42E ⊕ CROSS SLOT DIMENSION

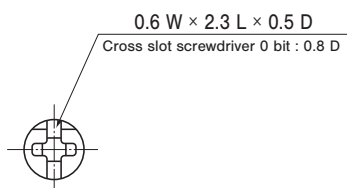

ST-4

SURFACE MOUNT TRIMMERS

PACKAGING SPECIFICATIONS

<Taping packaging specifications>

- Taping version is packaged in 500 pcs. per reel.
Orders will be accepted for units of 500 pcs., i.e., 500, 1000, 1500 pcs., etc.
- ST-4ETA, ETB and ETD versions are boxed with 4 reels (2000 pcs.).
ST-4ETG and ETH versions are boxed with one reel (500 pcs.).

Maximum number of consecutive missing pieces = 2
Leader length and reel dimension are shown in the diagrams below.

EMBOSSED TAPE DIMENSIONS

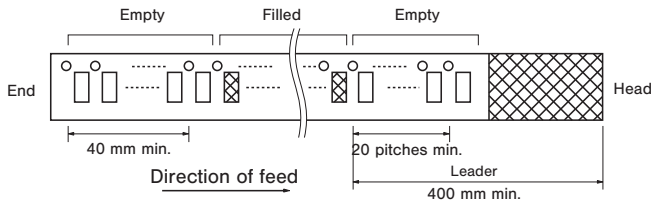

REEL DIMENSIONS

(Conforms to JIS C 0806-3)

(In accordance with EIAJ ET-7200A)

(Unit: mm)

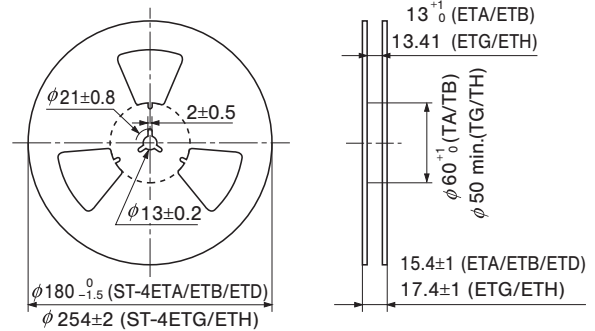

ST-4ETA/ETB/ETD

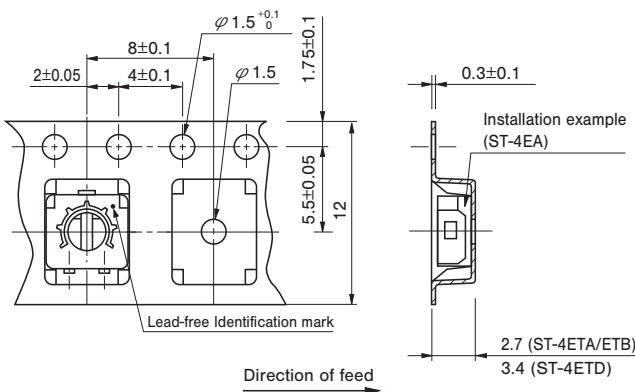

ST-4ETG/ETH

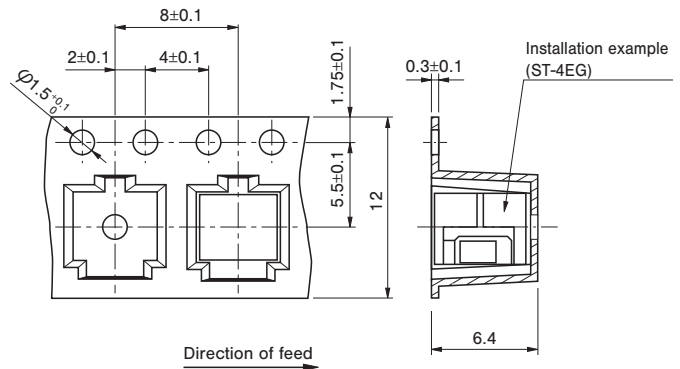



<Bulk pack specifications>

- Unit of bulk in a plastic bag is 100 pcs. per pack.
- Boxing of bulk in a plastic bag is performed with 500 pcs. per box.

Looking for pricing, stock, or lifecycle information?

Click below to explore more details on WIN SOURCE:

-  [View ST4ETA504 on WIN SOURCE](#)
-  [Nidec Copal Electronics Information](#)

Optimize Your Supply Chain with WIN SOURCE Solutions

-  Global Sourcing Solution
-  Obsolete Management
-  Cost Control Management
-  Shortage Management
-  Alternative Solution
-  Excess Inventory Management