



**THE DATASHEET OF
SPC5742PK1AMLQ9**



MPC574xP Microcontroller

Power Architecture®-based MCU
for Automotive and Industrial Applications

Product One-Sheet

Data Sheet

Tools

Buy

Performance—2 x e200z4 cores in delayed lockstep operating up to 200 MHz, embedded floating point unit, 32-channel eDMA in delayed lockstep

High Reliability—AEC-Q100, automotive quality, up to 135°C ambient temperature

Abundant Features—FlexCAN, LINFlexD, DSPI, SENT, LFAST SIPI support, Dual-channel FlexRay™, Ethernet

Functional Safety—Built to support functional safety (ISO 26262/ASIL D and IEC 61508 SIL3), end-to-end ECC

MPC574xP Specifications

Flash	Up to 2.5 MB	Timer/PWM	2 x FlexPWM w/ 4 x (2+1) ch.
RAM	Up to 384 KB	Other Timer	2 x eTimer w/ 6-ch., 1 x PIT / STM w/ 4-ch., SWT
Core	2 x e200z4 lockstep	Analog	4 x 12 bit ADC w/ 16-ch.
Speed	Up to 200 MHz	Comm	SENT, ADC, FlexCAN, FlexRay, LinFlex, DSPI, FlexPWM and SIPI/LFAST 3G IF
Package	144 LQFP/257 BGA		
Op Range	3.15 V to 5.5 V	Safety	Core/DMA lockstep, e2eECC, duplicate periphery, LBIST/MBIST, ADC self-test, FCCU
Temp	-40°C to up to 135°C		

Orderable Samples

Part Number	Temp. Range	Flash	SRAM	Package
SPC5744P	-40°C to 125°C	2.5 MB	384 KB	144 LQFP/257 BGA
SPC5743P	-40°C to 125°C	2 MB	256 KB	144 LQFP/257 BGA
SPC5742P	-40°C to 125°C	1.5 MB	192 KB	144 LQFP/257 BGA
SPC5741P	-40°C to 125°C	1 MB	128 KB	144 LQFP/257 BGA

MPC574xP Block Diagram

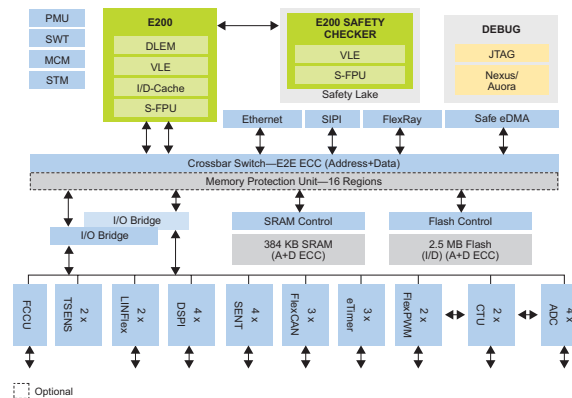

Motor Control Application

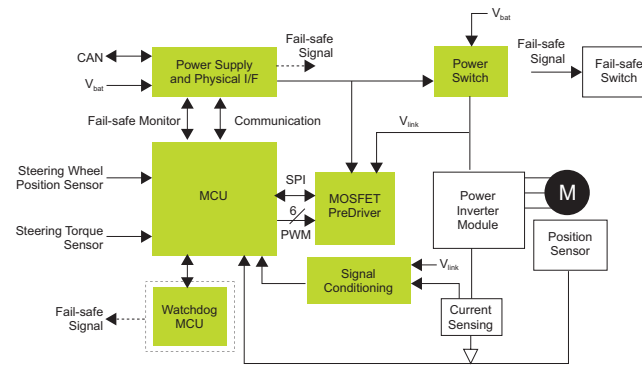

Success Stories

- ▶ Electronic power steering
- ▶ Wireless charging
- ▶ Shock controller
- ▶ DC-DC converter

Target Applications

- ▶ Electric power steering (EPS)
- ▶ Airbag system
- ▶ Safety domain control
- ▶ Safety motor controller
- ▶ Active driver assistance system
- ▶ Adaptive cruise control
- ▶ Braking and stability control
- ▶ Active suspension

Enablement Tools

- ▶ Development hardware:
 - Mother evaluation board
 - Daughter adapter boards
- ▶ Runtime software:
 - Flash and EEPROM driver
- ▶ Compiler: Green Hills, Wind River
- ▶ Debugger: Lauterbach, iSystem, PLS



www.nxp.com/MPC574xP

NXP, the NXP logo, Freescale, the Energy Efficient Solutions logo, SafeAssure and the SafeAssure logo are trademarks of NXP B.V. All other product or service names are the property of their respective owners. The Power Architecture and Power.org word marks and the Power and Power.org logos and related marks are trademarks and service marks licensed by Power.org. © 2014–2016 NXP B.V.

Document Number: MPC574xPFS REV 3



Looking for pricing, stock, or lifecycle information?

Click below to explore more details on WIN SOURCE:

 [View SPC5742PK1AMLQ9 on WIN SOURCE](#)

 [NXP / Nexperia Information](#)

Optimize Your Supply Chain with WIN SOURCE Solutions

-  Global Sourcing Solution
-  Obsolete Management
-  Cost Control Management
-  Shortage Management
-  Alternative Solution
-  Excess Inventory Management