





THE DATASHEET OF SM8S28CA



SPECIFICATION SHEET

SPECIFICATION SHEET NO.	N1115 - DO218ABM8S28CA
DATE	Nov. 15, 2021
REVISION	A0
DESCRIPTION	<p>SMD Transient Voltage Suppressor (TVS) Diodes, DO-218AB series, High Temperature Stability and High Reliability Conditions SM8S28CA Type, 2 Pads, Bi-directional Stand-off Voltage 28V. Reverse Surge Current. 145A Max. Operating Temp. Range -55°C ~+175°C Package in Tape/Reel, 750pcs/13" Reel RoHS/RoHS III compliant</p>
CUSTOMER	
CUSTOMER PART NUMBER	
CROSS REF. PART NUMBER	
ORIGINAL PART NUMBER	MDD SM8S28CA
PART CODE	DO218ABM8S28CA

VENDOR APPROVE			
Issued/Checked/Approved			
DATE: Nov. 15, 2021			

CUSTOMER APPROVE	
DATE:	

SMD TRANSIENT VOLTAGE SUPPRESSORS DO-218AB SERIES



MAIN FEATURE

- Round Chip Produced By Chemical Method
- Junction Passivated By Polyimide
- T J – 175 °C Capability Suitable For High Reliability And Automotive Requirement
- Available In both Uni-directional and Bi-directional Polarity
- Low Leakage Current
- Low Forward Voltage Drop
- High Surge Capability
- Meet ISO7637-2 Surge Specification (Varied By Test Condition)
- Meet MSL Level 1, Per J-STD_020, LF Max. Peak Of 245 °C
- AEC – Q101 Quality

APPLICATION

- Use In Sensitive Electronics Protection Against Voltage Transients Included By Inductive Load Switching And Lighting, Especially For Automotive Load Dump Protection Application

RFQ

[Request For Quotation](#)

PART CODE GUIDE

DO218AB	M8S28CA
1	2

1) **DO218AB**: SMD Transient Voltage Suppressor (TVs) Diodes, DO218AB series

2) **M8S28CA**: Type code for original part number SM8S28CA

SMD TRANSIENT VOLTAGE SUPPRESSORS DO-218AB SERIES

DIMENSION (Unit: mm)

Image for reference

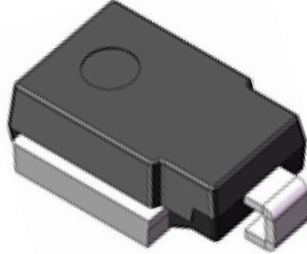

Marking: SM8S28CA

DO-218AB

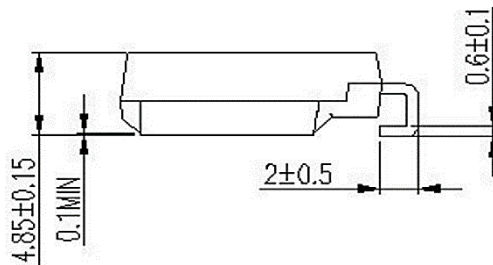
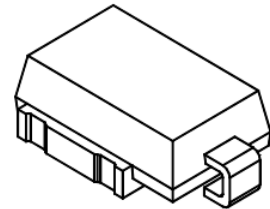
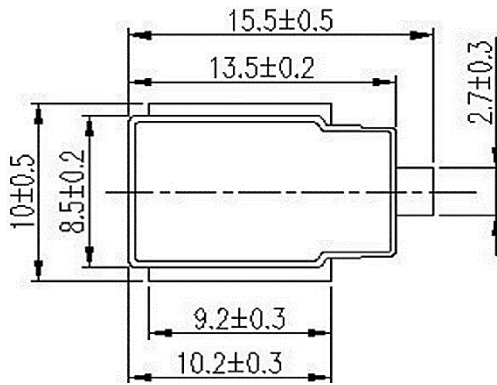

Recommend Pad Layout

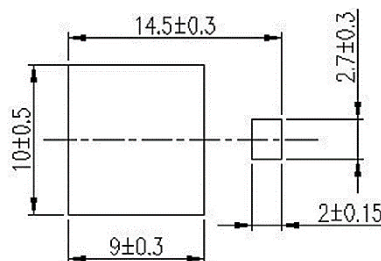

SMD TRANSIENT VOLTAGE SUPPRESSORS DO-218AB SERIES
MECHANICAL DATA

Case	Terminals	Polarity	Mounting Position	Unit Weight
JEDEC DO-218AB molded plastic	Matte tin plated leads, solderable per J-STD-002 & JESD22-B102	Heatsink is Anode	Meets UL 94 V-0 flammability rating base P/NHE3_X – RoHS Compliant & AEC – Q101 qualified (X: denotes revision code e. g A, B...)	2.60 g/pc

MAX. RATING & CHARACTERISTICS - Ratings at 25°C ambient temperature unless otherwise specified.

Parameter	SYMBOLS	VALUE			UNITS
		Min.	Typical	Max.	
Peak Pulse Power Dissipation @10/1000µs Waveform	P _{ppm}		6600		W
Peak Pulse Power Dissipation @10/1000µs Waveform	P _{ppm}		5200		W
Power Dissipation On Infinite Heatsink @ T _c = 25 °C (Fig. 1)	P _D		8.0		W
Peak Pulse Current On 10/1000µs Waveform (Note 1)	I _{ppm}			145	A
Peak Forward Surge Current 8.3 Ms Single Half Sine- Wave	I _{FSM}		700		A
Thermal Resistance Junction To Case	R _{θJA}		0.90		°C/W
Operating Junction Temperature Range	T _J	-55		+175	°C
Storage Temperature Range	T _{STG}	-55		+175	°C

Note

1. Non-repetitive current pulse derated above TA=25 °C

SMD TRANSIENT VOLTAGE SUPPRESSORS DO-218AB SERIES

ELECTRICAL CHARACTERISTICS - Ratings at 25°C

Parameter	SYMBOLS	VALUE			UNITS
		Min.	Typical	Max.	
Breakdown Voltage	V BR	31.1	32.8	34.4	V
Test Current	I T		5.0		mA
Reverse Stand-Off	V WM		28.0		V
Reverse Leakage @ V WM	I D			10.0	µA
Reverse Leakage @ V WM, T J = 175 °C	I D			150	µA
Peak Pulse Current @ 10/1000 µs Wave-form	I PPM			145	A
Clamping Voltage @ I PPM	V C			45.4	V
Temp. Coefficient of V BR (Note 1)	αT		0.089		%/ °C

Note

1. To calculate V BR vs Junction temperature, use the following formula: V BR at T J = V BR at 25 °C x 1+ αT x (T J -25)
2. For all type Max. V F = 1.8V at I F = 100 A measured on 8.3ms single half Sine-wave or equivalent square wave, duty cycle = 4 pulses per minute Max.

SMD TRANSIENT VOLTAGE SUPPRESSORS DO-218AB SERIES
RELIABILITY

Number	Experiment Items	Experiment Method And Conditions	Reference Documents
1	Solder Resistance Test	Test 260°C± 5°C for 10 ± 2 sec. Immerse body into solder 1/16" ± 1/32"	MIL-STD-750D METHOD-2031.2
2	Solderability Test	230°C ±5°C for 5 sec.	MIL-STD-750D METHOD-2026.1 0
3	Pull Test	1 kg in axial lead direction for 10 sec.	MIL-STD-750D METHOD-2036.4
4	Bend Test	0.5Kg Weight Applied To Each Lead, Bending Arcs 90 °C ± 5 °C For 3 Times	MIL-STD-750D METHOD-2036.4
5	High Temperature Reverse Bias Test	TA=100°C for 1000 Hours at VR=80% Rated VR	MIL-STD-750D METHOD-1038.4
6	Forward Operation Life Test	TA=25°C Rated Average Rectified Current	MIL-STD-750D METHOD-1027.3
7	Intermittent Operation Life Test	On state: 5 min with rated IRMS Power Off state: 5 min with Cool Forced Air. On and off for 1000 cycles.	MIL-STD-750D METHOD-1036.3
8	Pressure Cooker Test	15 PSIG, TA=121°C, 4 hours	MIL-S-19500 APPENOIXC
9	Temperature Cycling Test	-55°C~+125°C; 30 Minutes For Dwelled Time 5 minutes for transferred time. Total: 10 cycles.	MIL-STD-750D METHOD-1051.7
10	Thermal Shock Test	0°C for 5 minutes., 100°C for 5minutes, Total: 10 cycles	MIL-STD-750D METHOD-1056.7
11	Forward Surge Test	8.3ms Single Sale Sine-wave One Surge.	MIL-STD-750D METHOD-4066.4
12	Humidity Test	TA=65°C, RH=98% for 1000 hours.	MIL-STD-750D METHOD-1021.3
13	High Temperature Storage life Test	150°C for 1000 Hours	MIL-STD-750D METHOD-1031.5

SMD TRANSIENT VOLTAGE SUPPRESSORS DO-218AB SERIES

SUGGESTED REFLOW PROFILE (For Reference Only)

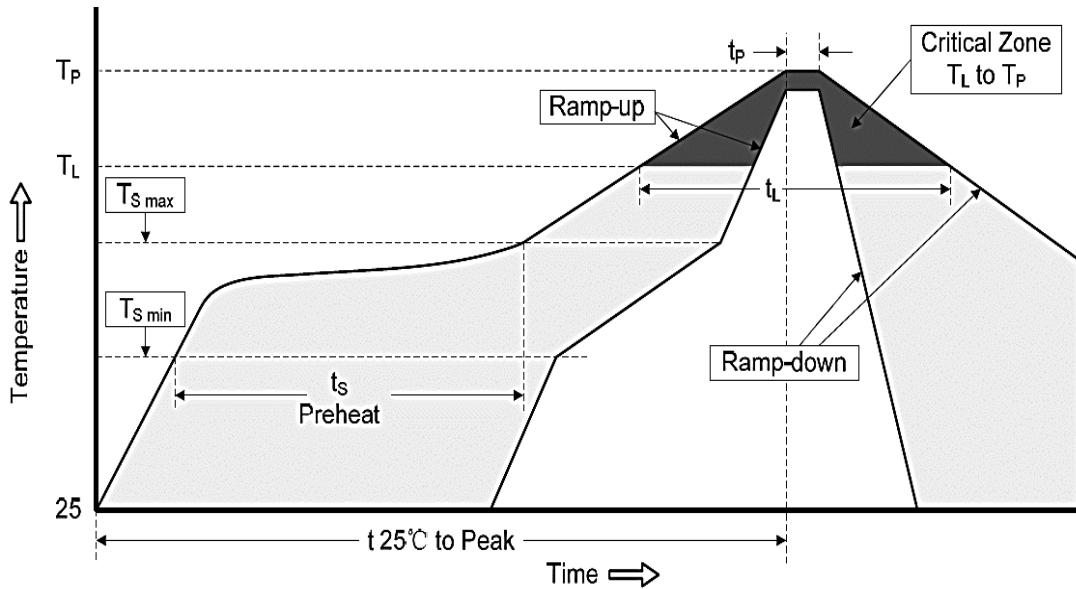

Profile Feature		Pb-Free Assembly
Average Ramp-up Rate (Ts Max to Tp)		3°C/second Max
Preheat	Temperature Min (Ts Min.)	150°C
	Temperature Max (Ts Max.)	200°C
	Time (ts Min. to ts Max.)	60 ~ 180 seconds
Time maintained above	Temperature (Tl)	217°C
	Time (tl)	60 ~ 150 seconds
Peak/Classification Temperature (Tp)		260 °C
Time within 5°C of actual Peak Temperature (tp)		20 ~ 40 seconds
Ramp-down rate		6 °C /Second Max.
Time 25 °C to Peak Temperature		6 minutes Max.
Suggest reflow times		3 Times Max.

SMD TRANSIENT VOLTAGE SUPPRESSORS DO-218AB SERIES

RATINGS AND CHARACTERISTIC CURVES (For Reference Only)

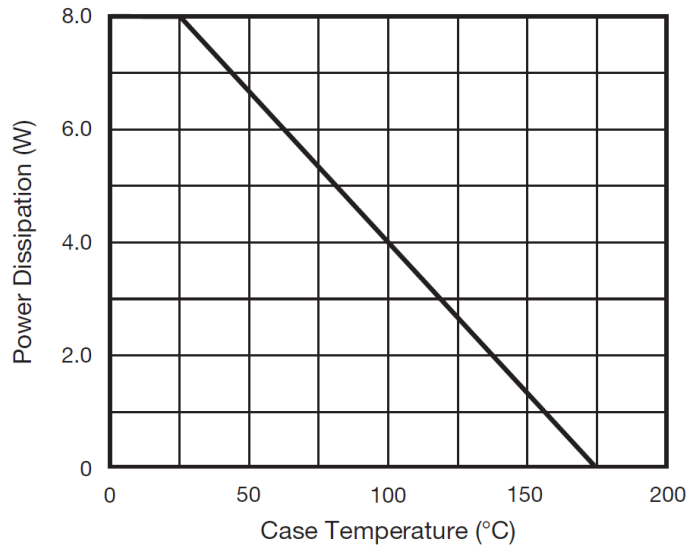

Fig. 1 - Power Derating Curve

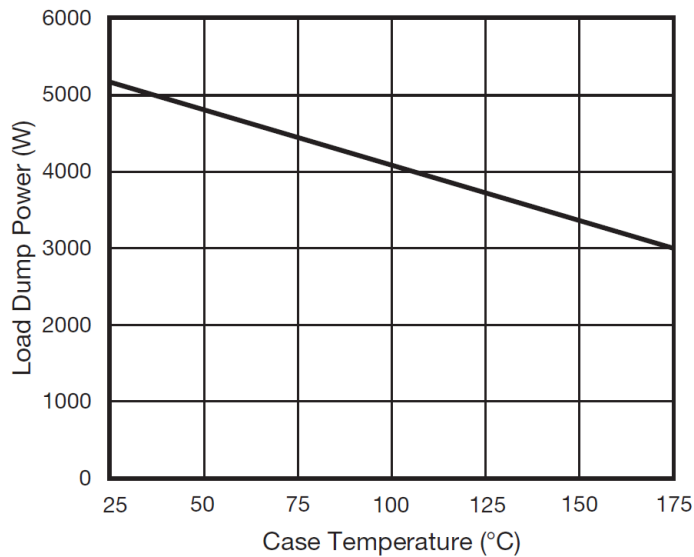

Fig. 2 - Load Dump Power Characteristics (10 ms Exponential Waveform)

SMD TRANSIENT VOLTAGE SUPPRESSORS DO-218AB SERIES

RATINGS AND CHARACTERISTIC CURVES (For Reference Only)

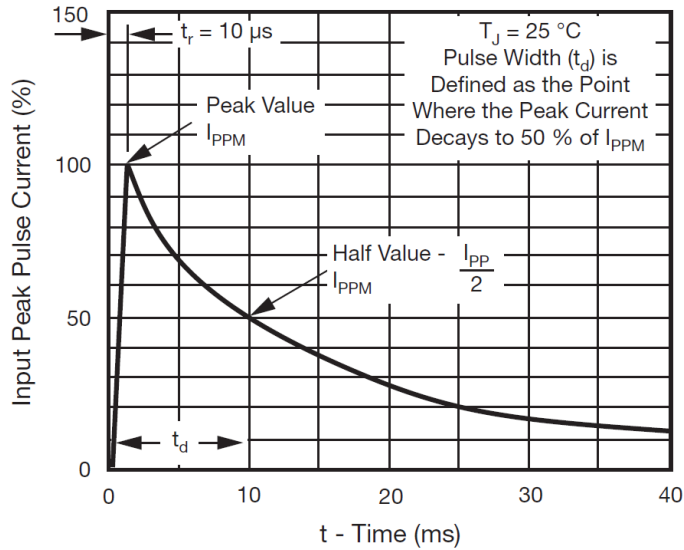

Fig. 3 - Pulse Waveform

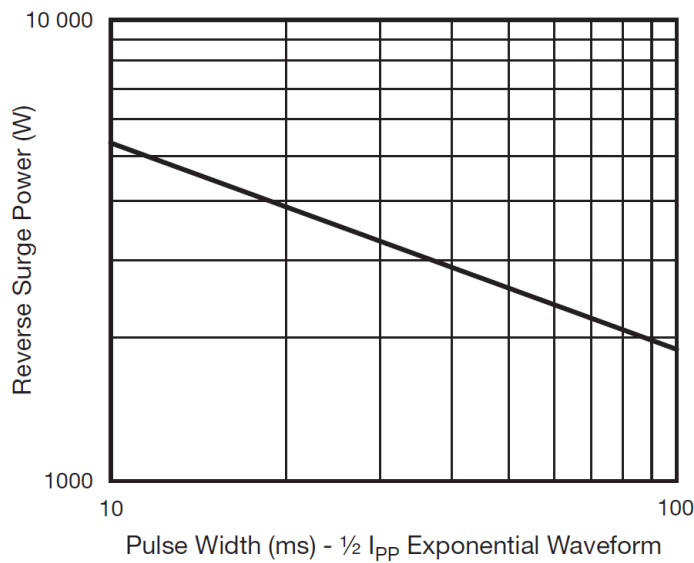

Fig. 4 - Reverse Power Capability

SMD TRANSIENT VOLTAGE SUPPRESSORS DO-218AB SERIES

RATINGS AND CHARACTERISTIC CURVES (For Reference Only)

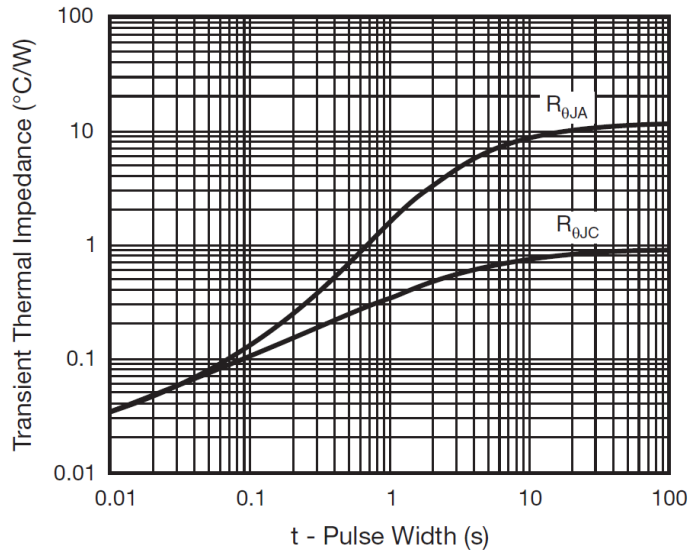

Fig. 5 - Typical Transient Thermal Impedance

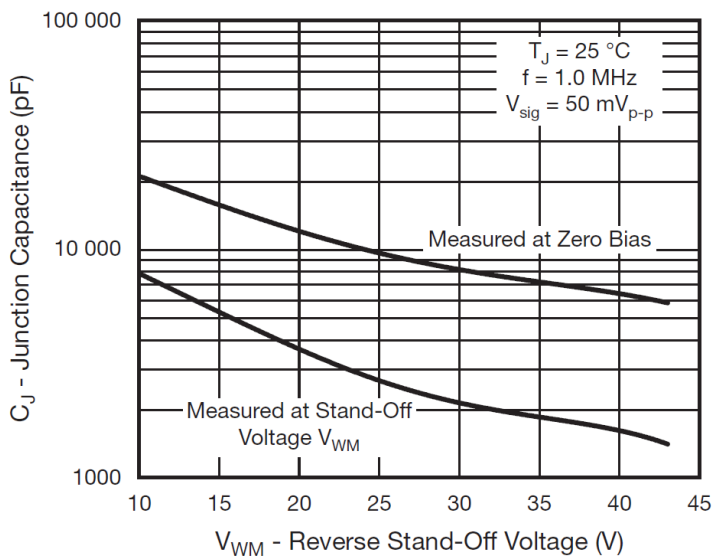
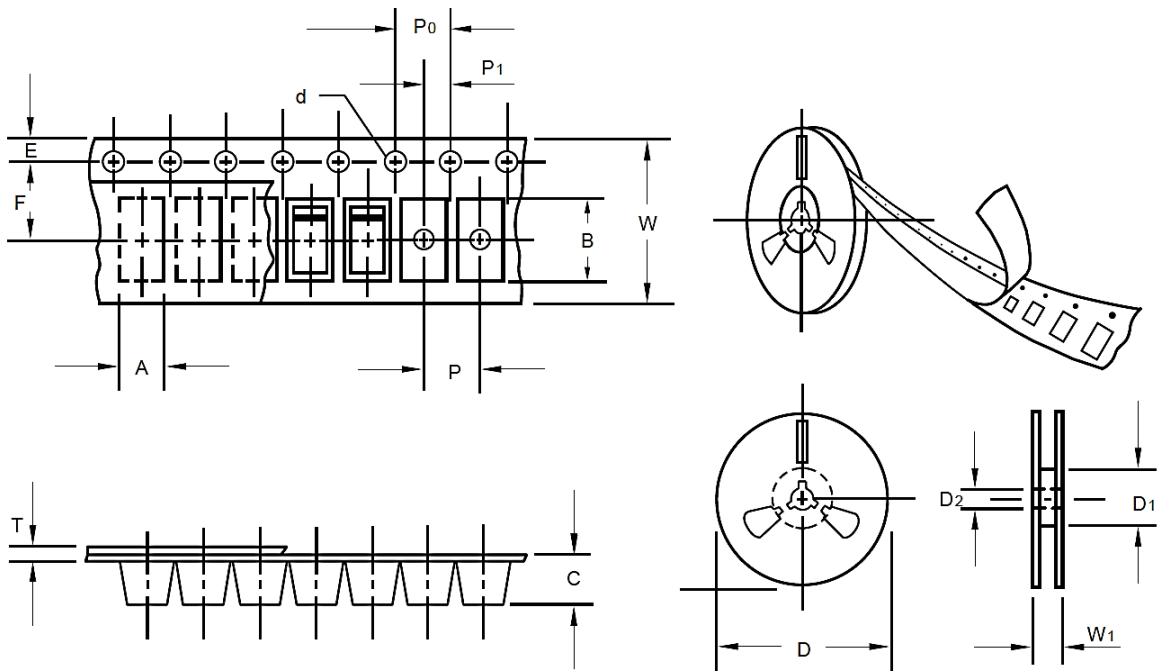

Fig. 6 - Typical Junction Capacitance

SMD TRANSIENT VOLTAGE SUPPRESSORS DO-218AB SERIES

TAPE/REEL (Unit: mm)

All Devices are packed in accordance with EIA standard RS-481-A and specifications. 750pcs/Reel



Item	Symbol	Tolerance	DO-218AB
Carrier width	A	+/-0.30	10.80
Carrier Length	B	+/-0.30	16.13
Carrier Depth	C	+/-0.20	6.00
Sprocket hole	d	+/-0.20	1.55
13"Reel outside diameter	D	+/-0.30	330.00
13"Reel inner diameter	D1	-	50.0 Min.
Feed hole diameter	D2	-	20.2 Min.
Sprocket hole position	E	+/-0.2	1.75
Punch hole position	F	+/-0.20	11.50
Punch hole pitch	P	+/-0.20	16.0
Sprocket hole pitch	P0	+/-0.20	4.00
Embossment center	P1	+/-0.20	2.00
Overall tape thickness	T	-	-
Tape width	W	+/-0.20	24.00
Reel width	W1	-	30.40 Max.

SMD TRANSIENT VOLTAGE SUPPRESSORS DO-218AB SERIES

PACKAGE for reference

Case Code	DO- 218AB
Reel Size	13"
Reel Size	330 mm
MPQ/Reel	750 pcs
Qty. /Box	1500 pcs
G.W/Box	5.5 kgs

DISCLAIMER

NextGen Component, Inc. reserves the right to make changes to the product(s) and or information contained herein without notice. No liability is assumed as a result of their use or application. No rights under any patent accompany the sale of any such product(s) or information

Looking for pricing, stock, or lifecycle information?

Click below to explore more details on WIN SOURCE:

 [View SM8S28CA on WIN SOURCE](#)

 [MDD Information](#)

Optimize Your Supply Chain with WIN SOURCE Solutions

-  Global Sourcing Solution
-  Obsolete Management
-  Cost Control Management
-  Shortage Management
-  Alternative Solution
-  Excess Inventory Management