

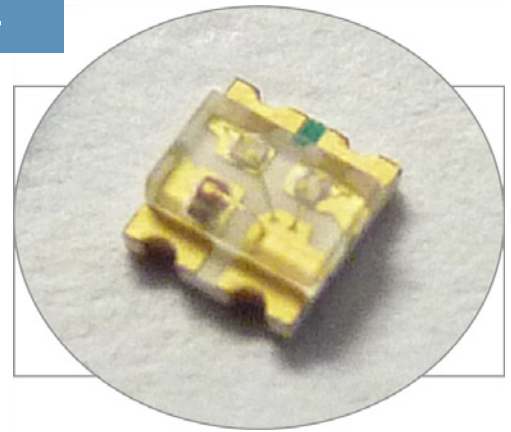

# THE DATASHEET OF SM0605RGB



# SURFACE MOUNT LED RED/GREEN/BLUE, 0605 PACKAGE



## SM0605RGB

- ◆ Industry Standard 0605 Package
- ◆ RoHS Compliant
- ◆ 3 Chips in One Small Package and Footprint
- ◆ Water Clear Lens
- ◆ Wide Viewing Angle
- ◆ Ideal for Status Indication, Display, and Backlighting

Bivar now offers its smallest Tri-Color Surface Mount LED to date which gives designers the edge they need for smaller board designs that require multiple color outputs. Its miniature size makes it ideal for almost any application where board space is a priority without compromise to quality, and it's long life and low power consumption are more than suitable for battery powered hand held devices and other portable products. This SM0605 LED is packaged in standard tape and reels for auto pick and place assemblies.

Part Number	Material	Emitted Color	Peak Wavelength $\lambda_p$ (nm) TYP.	Lens Appearance	Luminous Intensity (mcd) TYP.	Viewing Angle
SM0605RGB	AlGaInP	RED	630	Water Clear	120	120°
	InGaN	GREEN	523		700	
	InGaN	BLUE	468		145	

## Outline Dimensions

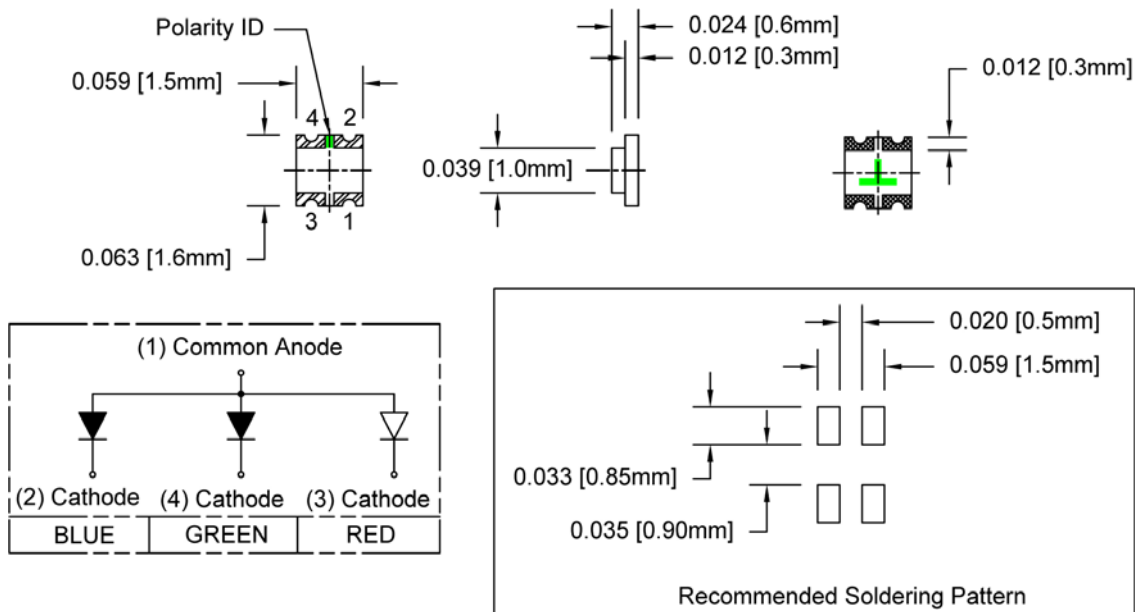

### Outline Drawings Notes:

1. All dimensions are in inches [millimeters].
2. Standard tolerance:  $\pm 0.10^\circ$  unless otherwise noted.



Bivar reserves the right to make changes at any time without notice.

# SURFACE MOUNT LED RED/GREEN/BLUE, 0605 PACKAGE



## Absolute Maximum Ratings

$T_A = 25^\circ\text{C}$  unless otherwise noted

Power Dissipation	Red - 78 mW Green - 108 mW Blue - 108 mW
Continuous Forward Current	Red - 30 mA Green - 25 mA Blue - 25 mA
Peak Forward Current <sup>1</sup>	100 mA
Reverse Voltage	5 V
Derating Linear From 25°C	0.4 mA/°C
Electrostatic Discharge (HBM)	2000 V
Operating Temperature Range	-30 ~ +80°C
Storage Temperature Range	-40 ~ +85°C
Lead Soldering Temperature <sup>2</sup>	260°C

Notes: 1.  $\leq 10\%$  Duty Cycle, Pulse Width  $\leq 0.1$  msec. 2. Solder time less than 5 seconds at temperature extreme.

## Electrical / Optical Characteristics

$T_A = 25^\circ\text{C}$  &  $I_F = 20$  mA unless otherwise noted

Part Number	Emitted Color	Forward Voltage (V)			Recommend Forward Current (mA)			Dominant Wavelength (nm)			Luminous Intensity $I_v$ (mcd)			Viewing Angle $2\theta_{1/2}$ (deg)
		MIN	TYP	MAX	MIN	TYP	MAX	MIN	TYP	MAX	MIN	TYP	MAX	TYP
SM0605RGB	Red	/	2.0	2.4	/	20	/	/	625	/	72	120	/	120
	Green	/	3.1	4.2	/	20	/	/	525	/	450	700	/	
	Blue	/	2.9	4.2	/	20	/	/	470	/	90	145	/	

## Typical Electrical / Optical Characteristics

$T_A = 25^\circ\text{C}$  &  $I_F = 20$  mA unless otherwise noted

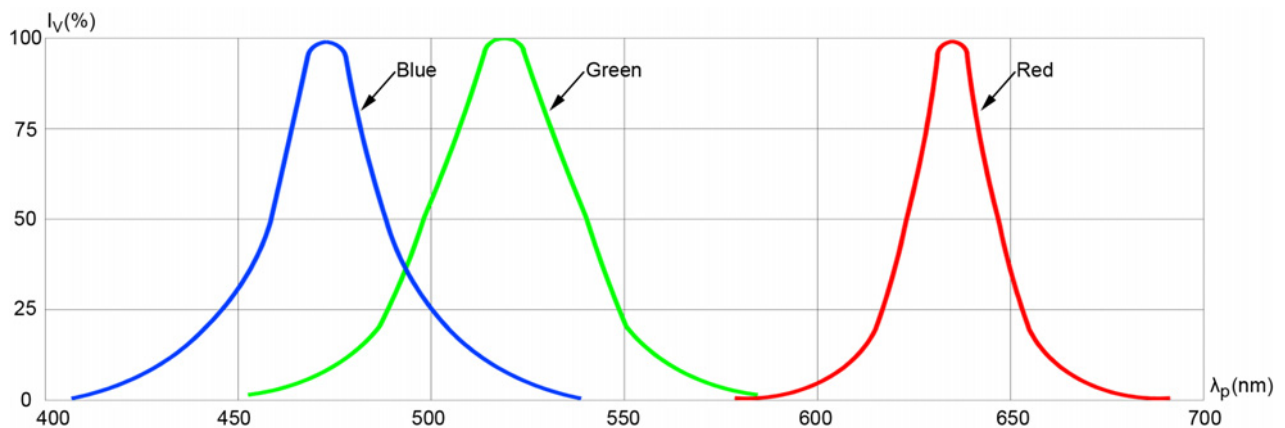

Fig. 1 Relative Luminous Intensity vs. Peak Wavelength

Bivar reserves the right to make changes at any time without notice.

## Typical Electrical / Optical Characteristics (Continued)

$T_A = 25^\circ\text{C}$  unless otherwise noted

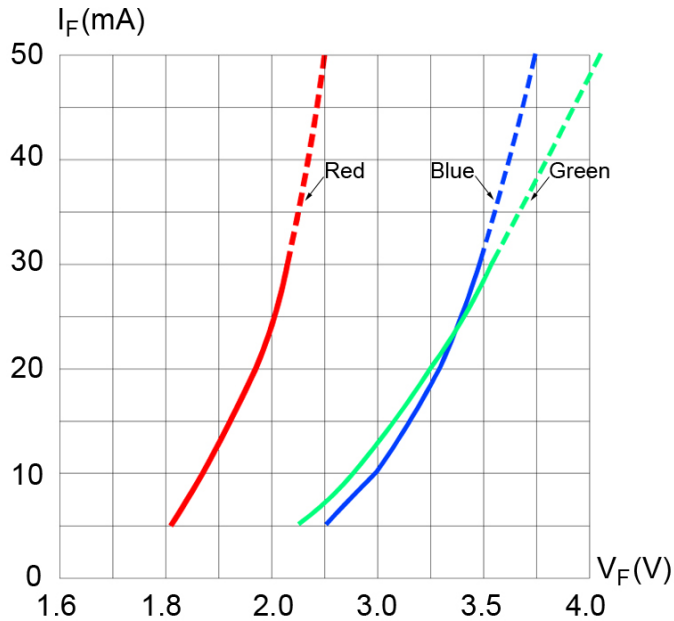

Fig. 2 Forward Current vs. Forward Voltage

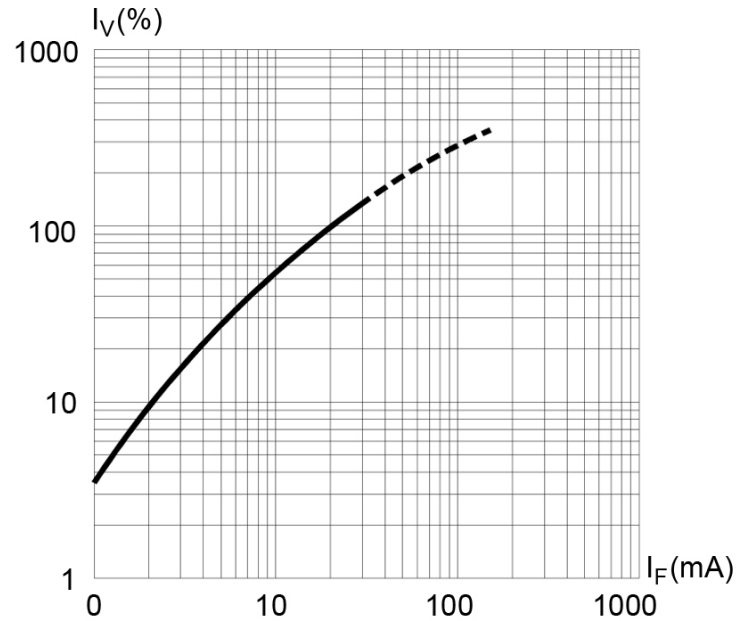

Fig. 3 Relative Luminous Intensity vs. Forward Current

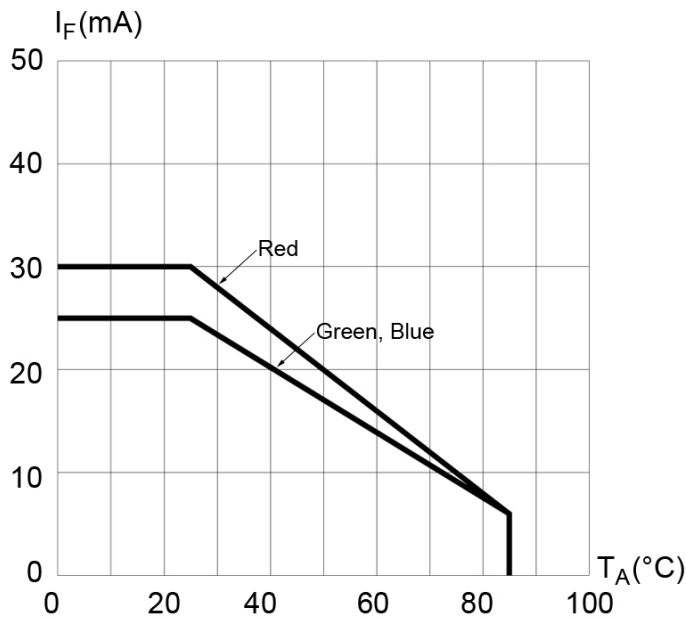

Fig. 4 Forward Current vs. Ambient Temperature

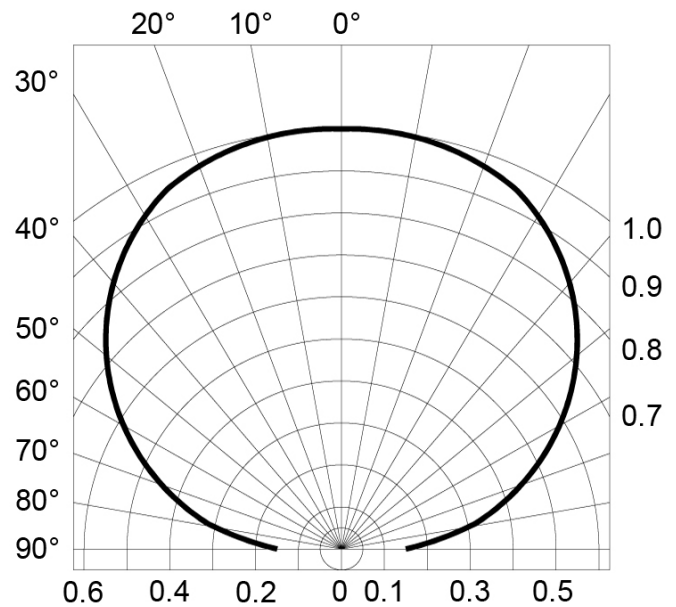

Fig. 5 Directivity Radiation Diagram

Bivar reserves the right to make changes at any time without notice.

# SURFACE MOUNT LED RED/GREEN/BLUE, 0605 PACKAGE



## Tape and Reel Dimensions

Note: 4000 pcs / Reel

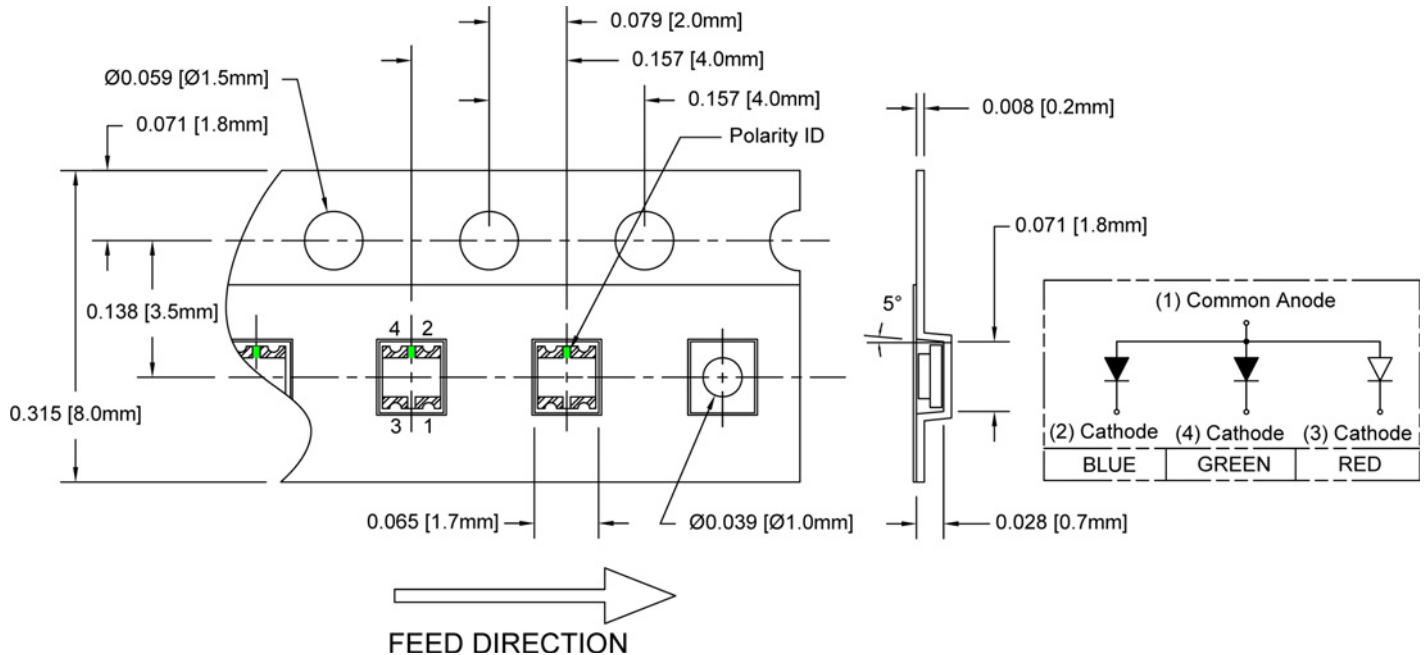

### Outline Drawings Notes:

1. All dimensions are in inches [millimeters].
2. Standard tolerance:  $\pm 0.10^\circ$  unless otherwise noted.

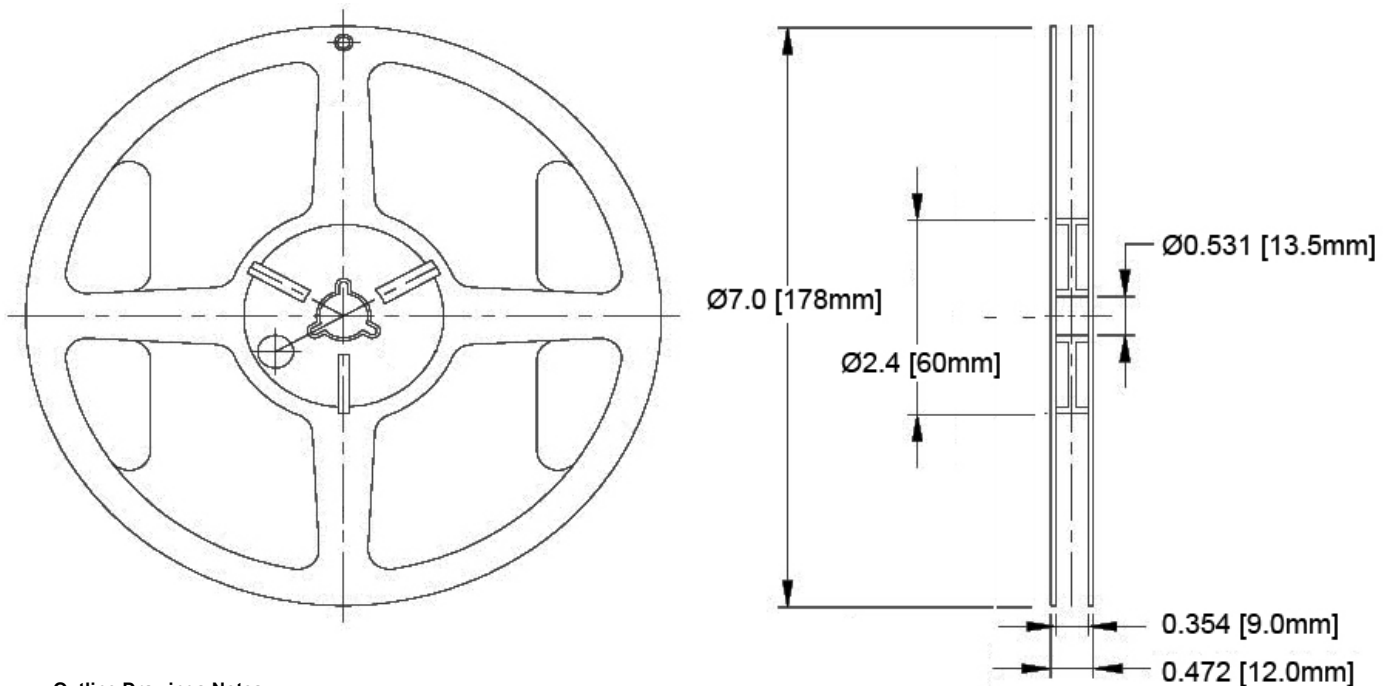

### Outline Drawings Notes:

1. All dimensions are in inches [millimeters].
2. Standard tolerance:  $.xxx \pm 0.10^\circ$ ,  $.x \pm 1^\circ$  unless otherwise noted.

Bivar reserves the right to make changes at any time without notice.

# SURFACE MOUNT LED RED/GREEN/BLUE, 0605 PACKAGE



## Packaging and Labeling Plan

Note: 1 Reel / Bag

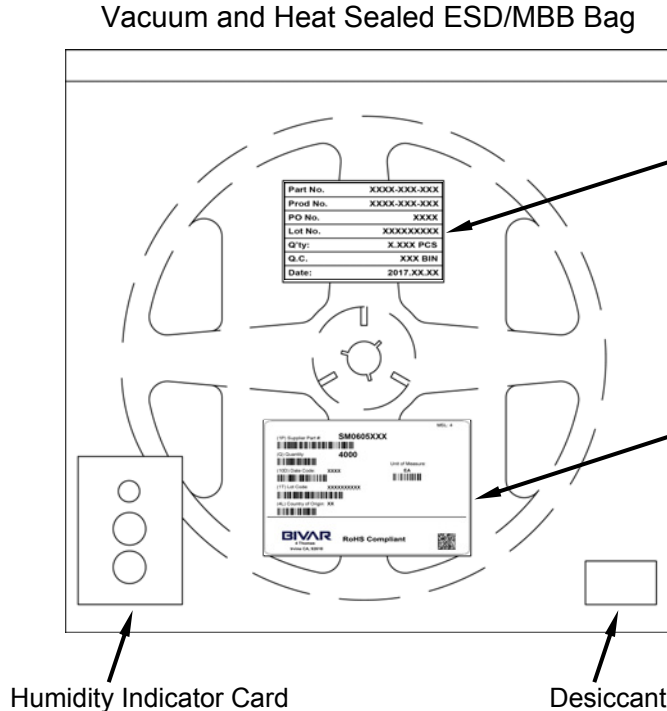

Part No.	XXXX-XXX-XXX
Prod No.	XXXX-XXX-XXX
PO No.	XXXX
Lot No.	XXXXXXXXXX
Q'ty:	X.XXX PCS
Q.C.	XXX BIN
Date:	2017.XX.XX

Internal Quality Control Label

MSL: 4

(1P) Supplier Part #: **SM0605XXX**

(Q) Quantity: **4000**

(10D) Date Code: **XXXX**

(1T) Lot Code: **XXXXXXXXXX**

(4L) Country of Origin: **XX**

Unit of Measure: **EA**

**BIVAR** RoHS Compliant

4 Thomas  
Irvine CA, 92618

Bivar Standard Packaging Label

## Recommended Soldering Conditions

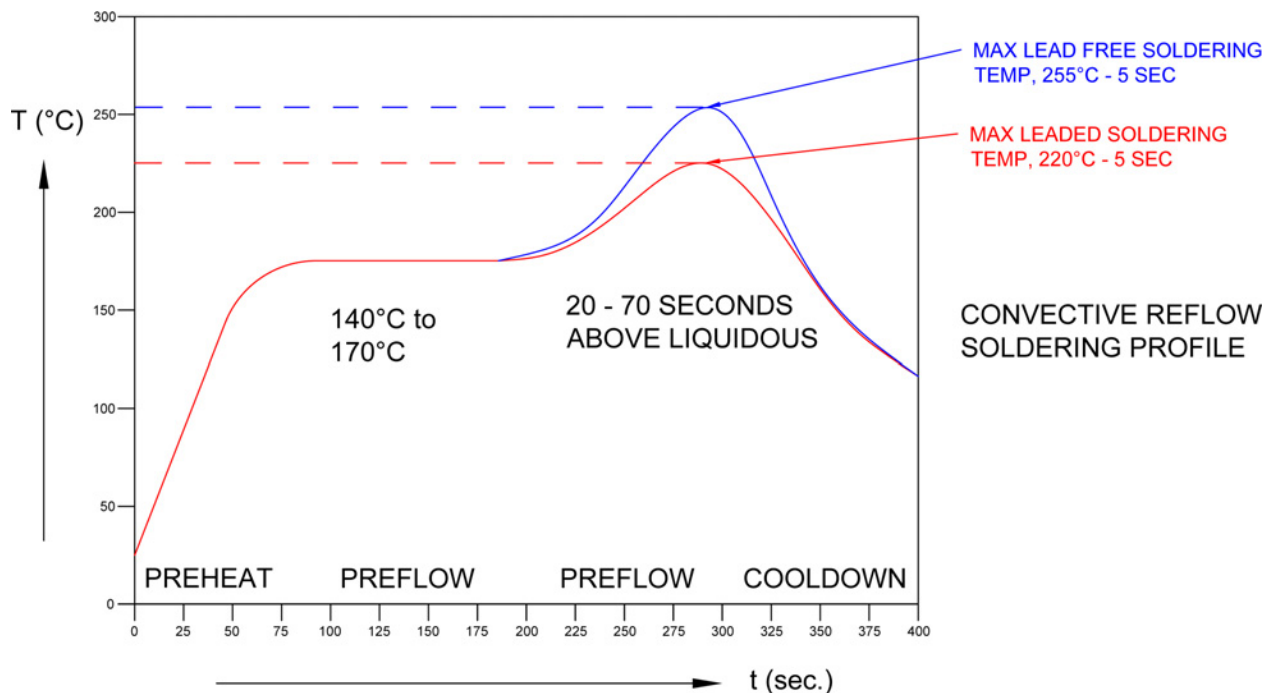

Bivar reserves the right to make changes at any time without notice.

## Looking for pricing, stock, or lifecycle information?

Click below to explore more details on WIN SOURCE:

 [View SM0605RGB on WIN SOURCE](#)

 [Bivar Inc. Information](#)

## Optimize Your Supply Chain with WIN SOURCE Solutions

-  Global Sourcing Solution
-  Obsolete Management
-  Cost Control Management
-  Shortage Management
-  Alternative Solution
-  Excess Inventory Management