



**THE DATASHEET OF
SKY13411-374LF**



DATA SHEET

SKY13411-374LF: 0.1 to 6.0 GHz DPDT Switch

Applications

- Dual-band wireless LANs (802.11 a/b/g/n)
- Diversity antenna switching

Features

- Broadband frequency range: 0.1 to 6.0 GHz
- Positive control voltage range: 1.8 to 5.0 V
- Low insertion loss: 0.6 dB typical @ 2.5 GHz
- High isolation: 23.5 dB typical @ 2.5 GHz
- P1dB: +31 dBm typical @ 3 V
- Small, MLPD (6-pin, 1.5 x 1.5 mm) Pb-free package (MSL1, 260 °C per JEDEC J-STD-020)



Skyworks Green™ products are compliant with all applicable legislation and are halogen-free. For additional information, refer to *Skyworks Definition of Green™*, document number SQ04-0074.

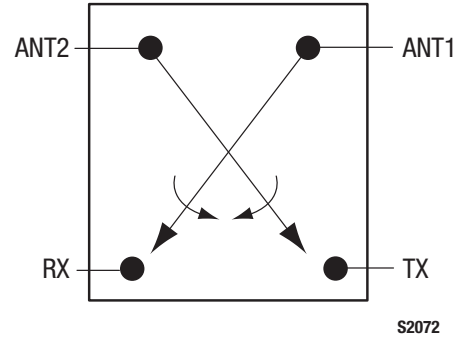

Figure 1. SKY13411-374LF Block Diagram

Description

The SKY13411-374LF is a pHEMT GaAs double-pole, double-throw (DPDT) switch designed for dual-band wireless LAN applications. The switch provides high linearity performance, low insertion loss, and high isolation.

Switching is controlled by two voltage inputs (V1 and V2). Depending on the logic voltage level applied to the control pins, the ANT1 and ANT2 pins connect to one of two switched RF outputs (RX or TX) through a low insertion loss path while maintaining a high isolation path to the alternate port.

The switch is manufactured in a compact, 1.5 x 1.5 mm, 6-pin exposed pad plastic Micro Leadframe Package Dual (MLPD) package.

A functional block diagram is shown in Figure 1. The pin configuration and package are shown in Figure 2. Signal pin assignments and functional pin descriptions are provided in Table 1.

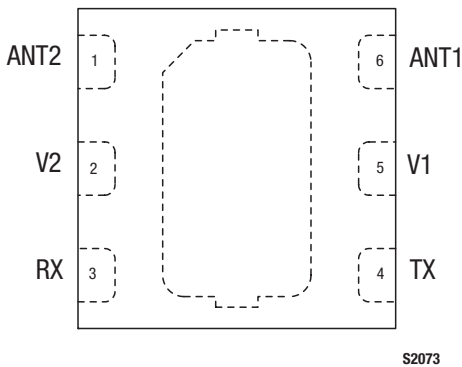

Figure 2. SKY13411-374LF Pinout – 6-Pin MLPD (Top View)

Table 1. SKY13411-374LF Signal Descriptions

Pin	Name	Description	Pin	Name	Description
1	ANT2	Antenna 2 RF port. Must be DC-blocked for proper operation.	4	TX	Transmit RF port. Must be DC-blocked for proper operation.
2	V2	DC control voltage 2	5	V1	DC control voltage 1
3	RX	Receive RF port. Must be DC-blocked for proper operation.	6	ANT1	Antenna 1 RF port. Must be DC-blocked for proper operation.

Note: Exposed backside ground pad must be properly grounded through a low impedance path.

Electrical and Mechanical Specifications

The absolute maximum ratings of the SKY13411-374LF are provided in Table 2. The recommended operating conditions are specified in Table 3 and electrical specifications are provided in Table 4.

Typical performance characteristics of the SKY13411-374LF are illustrated in Figures 3 through 8.

The state of the SKY13411-374LF is determined by the logic provided in Table 5.

Table 2. SKY13411-374LF Absolute Maximum Ratings

Parameter	Symbol	Minimum	Maximum	Units
Control voltage	V1, V2		6	V
RF input power	P _{IN}		+32	dBm
Storage temperature	T _{STG}	-40	+125	°C
Operating temperature	T _{OP}	-40	+85	°C

Note: Exposure to maximum rating conditions for extended periods may reduce device reliability. There is no damage to device with only one parameter set at the limit and all other parameters set at or below their nominal value. Exceeding any of the limits listed here may result in permanent damage to the device.

CAUTION: Although this device is designed to be as robust as possible, electrostatic discharge (ESD) can damage this device. This device must be protected at all times from ESD. Static charges may easily produce potentials of several kilovolts on the human body or equipment, which can discharge without detection. Industry-standard ESD precautions should be used at all times.

Table 3. SKY13411-374LF Recommended Operating Conditions

Parameter	Symbol	Minimum	Typical	Maximum	Units
Frequency	f	0.1		6.0	GHz
Control voltage	V1, V2	1.8	3.0	5.0	V

Table 4. SKY13411-374LF Electrical Specifications (Note 1)**($V_{CTL} = 0\text{ V}$ and $+3.0\text{ V}$, $T_{OP} = +25\text{ }^{\circ}\text{C}$, $P_{IN} = 0\text{ dBm}$, Characteristic Impedance [Z_0] = $50\text{ }\Omega$, Unless Otherwise Noted)**

Parameter	Symbol	Test Condition	Min	Typical	Max	Units
RF Specifications						
Insertion loss	IL	ANT1/ANT2 to RX/TX				
		0.1 to 1.0 GHz		0.50	0.65	dB
		1.0 to 2.5 GHz		0.60	0.75	dB
		2.5 to 4.0 GHz		0.80	0.90	dB
		4.0 to 6.0 GHz		0.90	1.20	dB
Isolation	Iso	ANT1/ANT2 to RX/TX, ANT1 to ANT2, TX to RX				
		0.1 to 1.0 GHz	23	26	dB	
		1.0 to 2.5 GHz	22	26	dB	
		2.5 to 4.0 GHz	15	19	dB	
		4.0 to 6.0 GHz	12	14	dB	
Return loss (Note 2)	IS111	ANT1/ANT2 to RX/TX, 0.1 to 4.0 GHz		15		dB
		4.0 to 6.0 GHz		15		dB
1 dB Input Compression Point	IP1dB	0.1 to 4.0 GHz		+31		dBm
		4.0 to 6.0 GHz		+30		dBm
0.1 dB Input Compression Point	IP0.1dB	0.1 to 4.0 GHz		+27		dBm
		4.0 to 6.0 GHz		+26		dBm
3 rd Order Input Intercept Point	IIP3	$P_{IN} = +20\text{ dBm/}$ tone, $\Delta f = 1\text{ MHz}$, 0.1 to 6.0 GHz		+50		dBm
2 nd harmonic	2fo	$P_{IN} = +20\text{ dBm}$, 0.1 to 6.0 GHz		-70		dBc
3 rd harmonic	3fo	$P_{IN} = +20\text{ dBm}$, 0.1 to 6.0 GHz		-70		dBc
Switching speed		50% V1/V2 to 90/10% RF		70		ns
		90/10% RF or 10/90% RF		35		ns
DC Specifications						
Control voltage: high low	V1, V2		1.8	3.0	5.0	V
			-0.2	0	0.2	V
Control current	I _{cc}			5		μA

Note 1: Performance is guaranteed only under the conditions listed in this table.**Note 2:** Lower frequency return loss is dependent on the DC blocking capacitor value.

Typical Performance Characteristics

($V_{CTL} = 0\text{ V}$ and $+3.0\text{ V}$, $T_{OP} = +25\text{ }^\circ\text{C}$, $P_{IN} = 0\text{ dBm}$, Characteristic Impedance $[Z_0] = 50\ \Omega$, Unless Otherwise Noted)

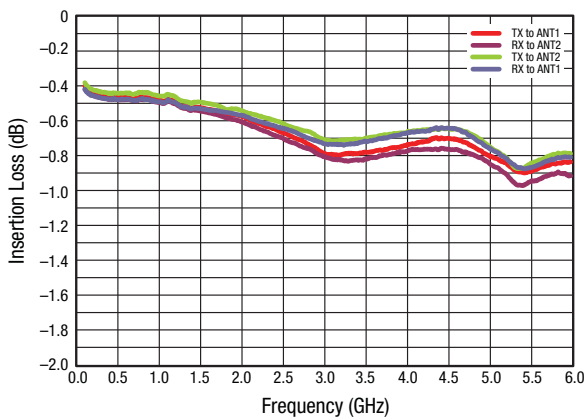

Figure 3. Insertion Loss vs Frequency

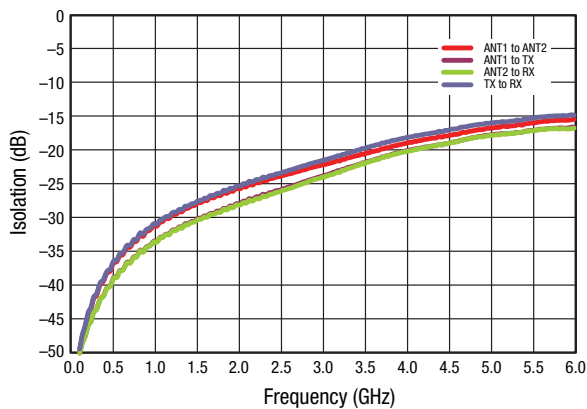

Figure 4. Isolation vs Frequency, ANT2-TX/ANT1-RX Insertion Loss Mode

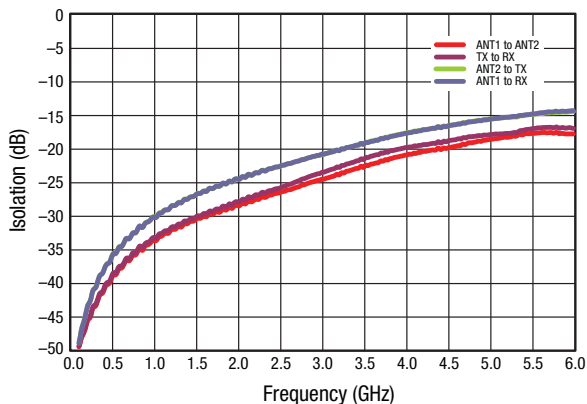

Figure 5. Isolation vs Frequency, ANT2-RX/ANT1-TX Insertion Loss Mode

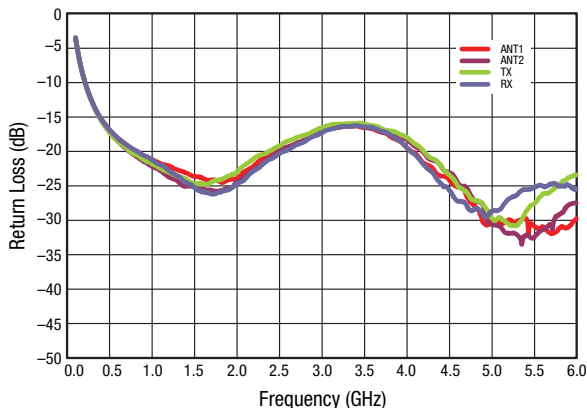

Figure 6. Return Loss vs Frequency,

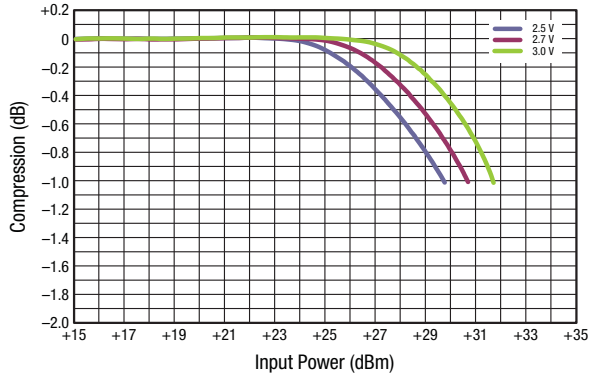

Figure 7. Compression vs Input Power @ 2.4 to 2.5 GHz

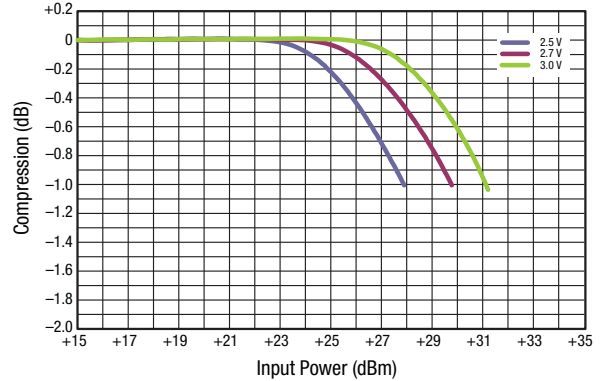

Figure 8. Compression vs Input Power @ 5 to 6 GHz

Table 5. SKY13411-374LF Truth Table

V1 (Pin 5)	V2 (Pin 2)	ANT1 (Pin 6) to TX (Pin 4)	ANT1 (Pin 6) to RX (Pin 3)	ANT2 (Pin 1) to TX (Pin 4)	ANT2 (Pin 1) to RX (Pin 3)
High	Low	Isolation state	Insertion loss state	Insertion loss state	Isolation state
Low	High	Insertion loss state	Isolation state	Isolation state	Insertion loss state

Note: High = +1.8 V to +5 V. Low = -0.2 V to +0.2 V.

Evaluation Board Description

The SKY13411-374LF Evaluation Board is used to test the performance of the SKY13411-374LF SPDT Switch. An Evaluation Board schematic diagram is provided in Figure 9. An assembly drawing for the Evaluation Board is shown in Figure 10.

Package Dimensions

The PCB layout footprint for the SKY13411-374LF is provided in Figure 11. Typical case markings are shown in Figure 12. Package dimensions for the 6-pin MLPD are shown in Figure 13, and tape and reel dimensions are provided in Figure 14.

Package and Handling Information

Instructions on the shipping container label regarding exposure to moisture after the container seal is broken must be followed. Otherwise, problems related to moisture absorption may occur when the part is subjected to high temperature during solder assembly.

The SKY13411-374LF is rated to Moisture Sensitivity Level 1 (MSL1) at 260 °C. It can be used for lead or lead-free soldering. For additional information, refer to the Skyworks Application Note, *Solder Reflow Information*, document number 200164.

Care must be taken when attaching this product, whether it is done manually or in a production solder reflow environment. Production quantities of this product are shipped in a standard tape and reel format.

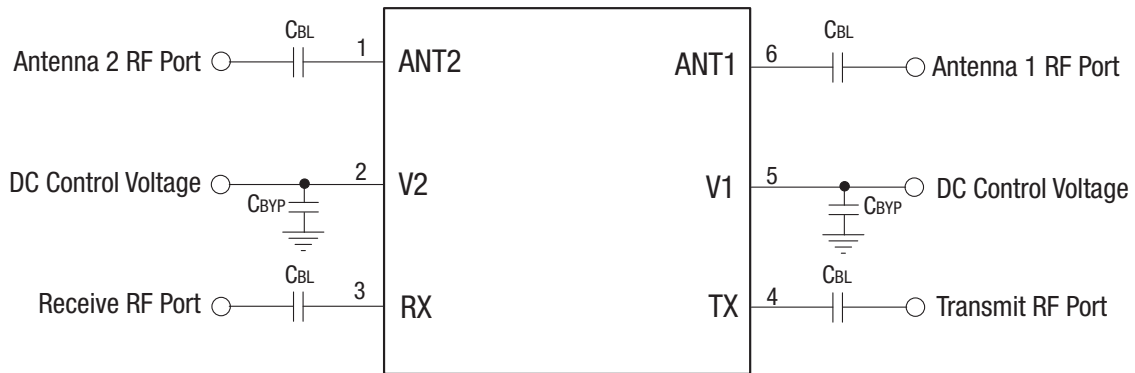

S2074

Figure 9. SKY13411-374LF Evaluation Board Schematic

Table 6. SKY13411-374LF Evaluation Board Bill of Materials

Component	Value	Size	Manufacturer	Characteristic
CBL	47 pF	0402	Murata GRM Series	DC blocking capacitor
CBYP	10 pF	0402	Murata GRM Series	Decoupling capacitor

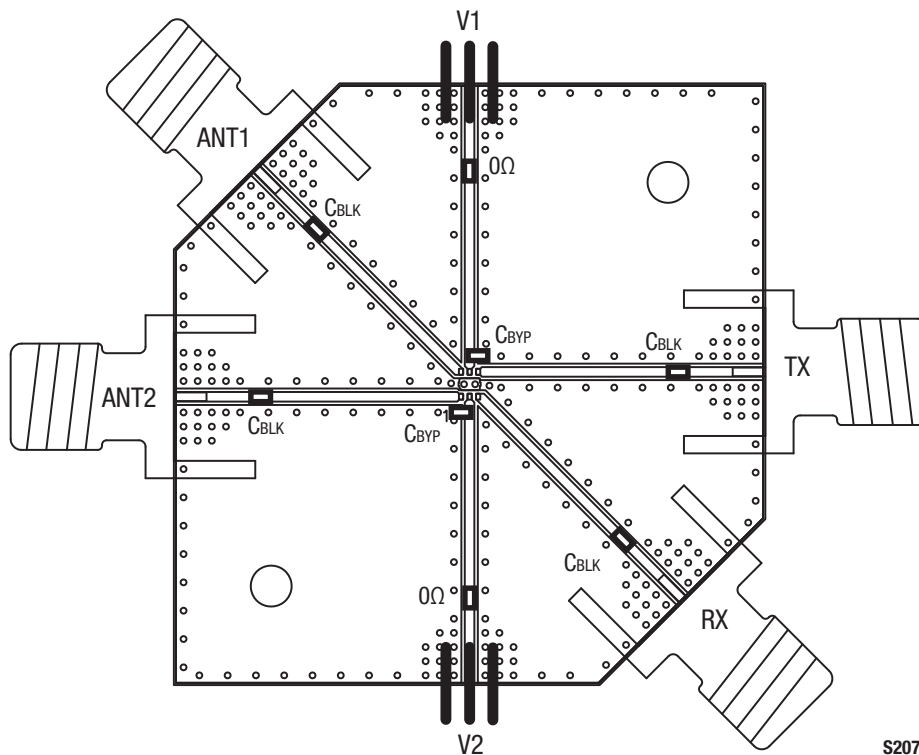

S2075

Figure 10. SKY13411-374LF Evaluation Board Assembly Diagram

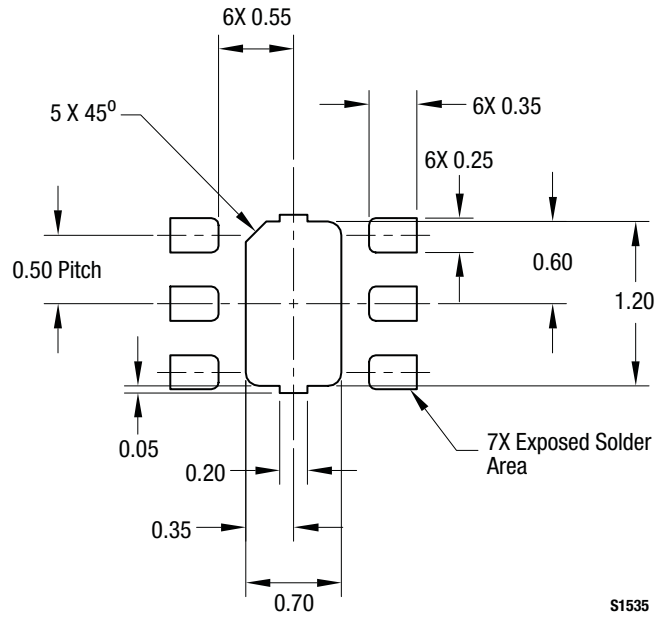

Figure 11. SKY13411-374LF PCB Layout Footprint (Top View)

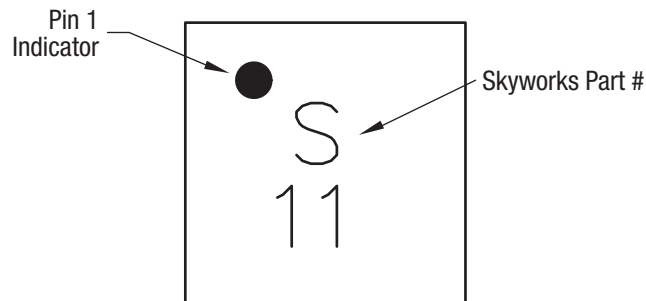
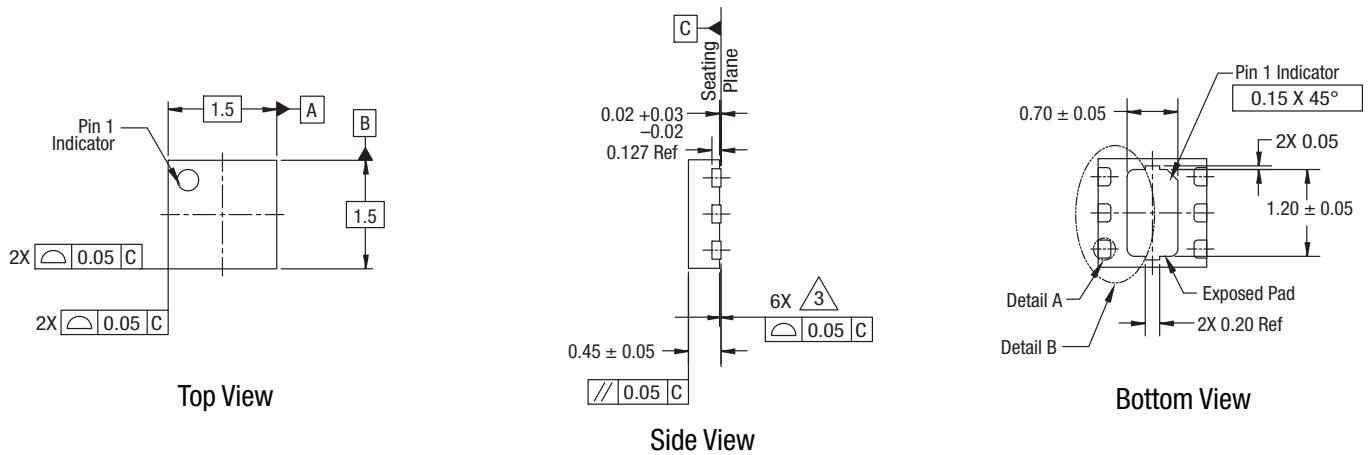

Figure 12. Typical Part Markings (Top View)



Notes:

1. Dimensions and tolerances according to ASME Y14.5M-1994.
2. Dimensions are in millimeters.
3. Coplanarity applies to the exposed heat sink slug as well as the terminals.
4. Plating requirement per source control drawing (SCD) 2504.
5. Dimension applies to metallized terminal, not measured in the radius area.

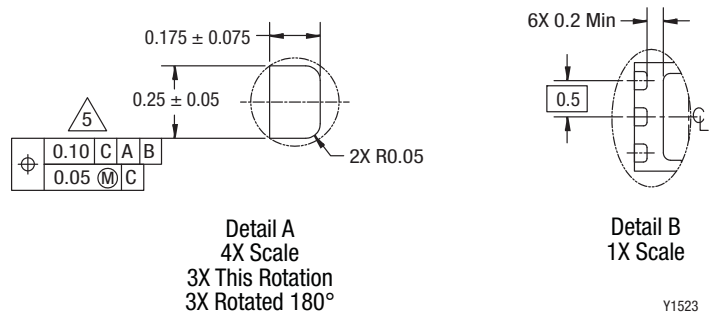
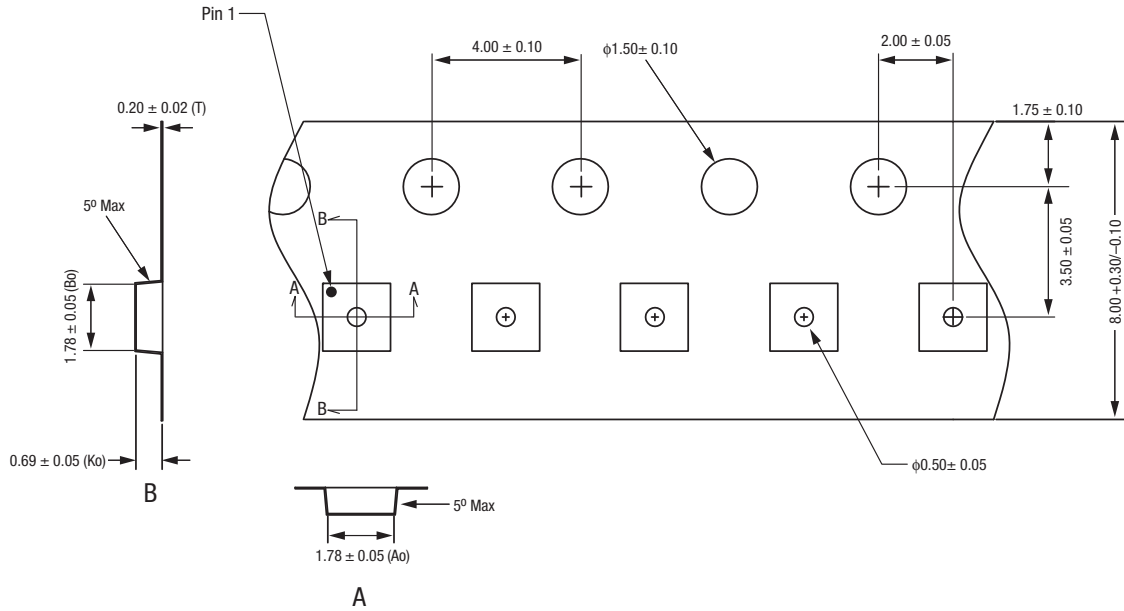

Figure 13. SKY13411-374LF 6-Pin QFN Package Dimensions

Y1523



- Notes:
1. Carrier tape: black conductive polycarbonate or polystyrene.
 2. Cover tape material: transparent conductive PSA.
 3. Cover tape size: 5.4 mm width.
 4. All measurements are in millimeters.

S1382a

Figure 14. SKY13411-374LF Tape and Reel Dimensions

Ordering Information

Model Name	Manufacturing Part Number	Evaluation Board Part Number
SKY13411-374LF: 0.1 to 6.0 GHz DPDT Switch	SKY13411-374LF	SKY13411-374LF-EVB

Copyright © 2011-2012, 2014 Skyworks Solutions, Inc. All Rights Reserved.

Information in this document is provided in connection with Skyworks Solutions, Inc. ("Skyworks") products or services. These materials, including the information contained herein, are provided by Skyworks as a service to its customers and may be used for informational purposes only by the customer. Skyworks assumes no responsibility for errors or omissions in these materials or the information contained herein. Skyworks may change its documentation, products, services, specifications or product descriptions at any time, without notice. Skyworks makes no commitment to update the materials or information and shall have no responsibility whatsoever for conflicts, incompatibilities, or other difficulties arising from any future changes.

No license, whether express, implied, by estoppel or otherwise, is granted to any intellectual property rights by this document. Skyworks assumes no liability for any materials, products or information provided hereunder, including the sale, distribution, reproduction or use of Skyworks products, information or materials, except as may be provided in Skyworks Terms and Conditions of Sale.

THE MATERIALS, PRODUCTS AND INFORMATION ARE PROVIDED "AS IS" WITHOUT WARRANTY OF ANY KIND, WHETHER EXPRESS, IMPLIED, STATUTORY, OR OTHERWISE, INCLUDING FITNESS FOR A PARTICULAR PURPOSE OR USE, MERCHANTABILITY, PERFORMANCE, QUALITY OR NON-INFRINGEMENT OF ANY INTELLECTUAL PROPERTY RIGHT; ALL SUCH WARRANTIES ARE HEREBY EXPRESSLY DISCLAIMED. SKYWORKS DOES NOT WARRANT THE ACCURACY OR COMPLETENESS OF THE INFORMATION, TEXT, GRAPHICS OR OTHER ITEMS CONTAINED WITHIN THESE MATERIALS. SKYWORKS SHALL NOT BE LIABLE FOR ANY DAMAGES, INCLUDING BUT NOT LIMITED TO ANY SPECIAL, INDIRECT, INCIDENTAL, STATUTORY, OR CONSEQUENTIAL DAMAGES, INCLUDING WITHOUT LIMITATION, LOST REVENUES OR LOST PROFITS THAT MAY RESULT FROM THE USE OF THE MATERIALS OR INFORMATION, WHETHER OR NOT THE RECIPIENT OF MATERIALS HAS BEEN ADVISED OF THE POSSIBILITY OF SUCH DAMAGE.

Skyworks products are not intended for use in medical, lifesaving or life-sustaining applications, or other equipment in which the failure of the Skyworks products could lead to personal injury, death, physical or environmental damage. Skyworks customers using or selling Skyworks products for use in such applications do so at their own risk and agree to fully indemnify Skyworks for any damages resulting from such improper use or sale.

Customers are responsible for their products and applications using Skyworks products, which may deviate from published specifications as a result of design defects, errors, or operation of products outside of published parameters or design specifications. Customers should include design and operating safeguards to minimize these and other risks. Skyworks assumes no liability for applications assistance, customer product design, or damage to any equipment resulting from the use of Skyworks products outside of stated published specifications or parameters.

Skyworks and the Skyworks symbol are trademarks or registered trademarks of Skyworks Solutions, Inc., in the United States and other countries. Third-party brands and names are for identification purposes only, and are the property of their respective owners. Additional information, including relevant terms and conditions, posted at www.skyworksinc.com, are incorporated by reference.

Looking for pricing, stock, or lifecycle information?

Click below to explore more details on WIN SOURCE:

 [View SKY13411-374LF on WIN SOURCE](#)

 [Skyworks Solutions Inc. Information](#)

Optimize Your Supply Chain with WIN SOURCE Solutions

-  Global Sourcing Solution
-  Obsolete Management
-  Cost Control Management
-  Shortage Management
-  Alternative Solution
-  Excess Inventory Management