



**THE DATASHEET OF  
SIT9121AC-1D3-33E187.500000**



### Features

- Any frequency between 1 MHz and 220 MHz accurate to 6 decimal places
- LVPECL and LVDS output signaling types
- 0.6ps RMS phase jitter (random) over 12 kHz to 20 MHz bandwidth
- Frequency stability as low as  $\pm 10$  ppm
- Industrial and extended commercial temperature ranges
- Industry-standard packages: 3.2 x 2.5, 5.0 x 3.2 and 7.0 x 5.0 mm x mm
- For other frequencies, refer to [SiT9120](#) and [SiT9122](#) datasheets

### Applications

- 10 GB Ethernet, SONET, SATA, SAS, Fibre Channel, PCI-Express
- Telecom, networking, instrumentation, storage, server



### Electrical Characteristics

Table 1. Electrical Characteristics

Parameters	Symbol	Min.	Typ.	Max.	Unit	Condition
<b>LVPECL and LVDS, Common Electrical Characteristics</b>						
Supply Voltage	V <sub>dd</sub>	2.97	3.3	3.63	V	
		2.25	2.5	2.75	V	
		2.25	–	3.63	V	Termination schemes in <a href="#">Figures 1 and 2</a> - XX ordering code
Output Frequency Range	f	1	–	220	MHz	
Frequency Stability	F <sub>stab</sub>	-10	–	+10	ppm	Inclusive of initial tolerance, operating temperature, rated power supply voltage, and load variations
		-20	–	+20	ppm	
		-25	–	+25	ppm	
		-50	–	+50	ppm	
First Year Aging	F <sub>aging1</sub>	-2	–	+2	ppm	25°C
10-year Aging	F <sub>aging10</sub>	-5	–	+5	ppm	25°C
Operating Temperature Range	T <sub>use</sub>	-40	–	+85	°C	Industrial
		-20	–	+70	°C	Extended Commercial
Input Voltage High	V <sub>IH</sub>	70%	–	–	V <sub>dd</sub>	Pin 1, OE or $\overline{ST}$
Input Voltage Low	V <sub>IL</sub>	–	–	30%	V <sub>dd</sub>	Pin 1, OE or $\overline{ST}$
Input Pull-up Impedance	Z <sub>in</sub>	–	100	250	k $\Omega$	Pin 1, OE logic high or logic low, or $\overline{ST}$ logic high
		2	–	–	M $\Omega$	Pin 1, $\overline{ST}$ logic low
Start-up Time	T <sub>start</sub>	–	6	10	ms	Measured from the time V <sub>dd</sub> reaches its rated minimum value.
Resume Time	T <sub>resume</sub>	–	6	10	ms	In Standby mode, measured from the time $\overline{ST}$ pin crosses 50% threshold.
Duty Cycle	DC	45	–	55	%	<a href="#">Contact SiTime</a> for tighter duty cycle
<b>LVPECL, DC and AC Characteristics</b>						
Current Consumption	I <sub>dd</sub>	–	61	69	mA	Excluding Load Termination Current, V <sub>dd</sub> = 3.3V or 2.5V
OE Disable Supply Current	I <sub>OE</sub>	–	–	35	mA	OE = Low
Output Disable Leakage Current	I <sub>leak</sub>	–	–	1	$\mu$ A	OE = Low
Standby Current	I <sub>std</sub>	–	–	100	$\mu$ A	$\overline{ST}$ = Low, for all V <sub>dds</sub>
Maximum Output Current	I <sub>driver</sub>	–	–	30	mA	Maximum average current drawn from OUT+ or OUT-
Output High Voltage	V <sub>OH</sub>	V <sub>dd</sub> -1.1	–	V <sub>dd</sub> -0.7	V	See <a href="#">Figure 1(a)</a>
Output Low Voltage	V <sub>OL</sub>	V <sub>dd</sub> -1.9	–	V <sub>dd</sub> -1.5	V	See <a href="#">Figure 1(a)</a>
Output Differential Voltage Swing	V <sub>Swing</sub>	1.2	1.6	2.0	V	See <a href="#">Figure 1(b)</a>
Rise/Fall Time	T <sub>r</sub> , T <sub>f</sub>	–	300	700	ps	20% to 80%, see <a href="#">Figure 1(a)</a>
OE Enable/Disable Time	T <sub>oe</sub>	–	–	115	ns	f = 212.5 MHz - For other frequencies, T <sub>oe</sub> = 100ns + 3 period
RMS Period Jitter	T <sub>jitt</sub>	–	1.2	1.7	ps	f = 100 MHz, V <sub>DD</sub> = 3.3V or 2.5V
		–	1.2	1.7	ps	f = 156.25 MHz, V <sub>DD</sub> = 3.3V or 2.5V
		–	1.2	1.7	ps	f = 212.5 MHz, V <sub>DD</sub> = 3.3V or 2.5V
RMS Phase Jitter (random)	T <sub>phj</sub>	–	0.6	0.85	ps	f = 156.25 MHz, Integration bandwidth = 12 kHz to 20 MHz, all V <sub>dds</sub>

**Table 1. Electrical Characteristics (continued)**

Parameter	Symbol	Min.	Typ.	Max.	Unit	Condition
<b>LVDS, DC and AC Characteristics</b>						
<b>Current Consumption</b>	I <sub>dd</sub>	–	47	55	mA	Excluding Load Termination Current, V <sub>dd</sub> = 3.3V or 2.5V
<b>OE Disable Supply Current</b>	I <sub>OE</sub>	–	–	35	mA	OE = Low
<b>Differential Output Voltage</b>	VOD	250	350	450	mV	See <a href="#">Figure 2</a>
<b>Output Disable Leakage Current</b>	I <sub>leak</sub>	–	–	1	μA	OE = Low
<b>Standby Current</b>	I <sub>std</sub>	–	–	100	μA	$\overline{ST}$ = Low, for all V <sub>dds</sub>
<b>Delta VOD</b>	ΔVOD	–	–	50	mV	See <a href="#">Figure 2</a>
<b>Offset Voltage</b>	VOS	1.125	1.2	1.375	V	See <a href="#">Figure 2</a>
<b>Delta VOS</b>	ΔVOS	–	–	50	mV	See <a href="#">Figure 2</a>
<b>Rise/Fall Time</b>	T <sub>r</sub> , T <sub>f</sub>	–	495	700	ps	20% to 80%, see <a href="#">Figure 2</a>
<b>OE Enable/Disable Time</b>	T <sub>oe</sub>	–	–	115	ns	f = 212.5 MHz - For other frequencies, T <sub>oe</sub> = 100ns + 3 period
<b>RMS Period Jitter</b>	T <sub>jitt</sub>	–	1.2	1.7	ps	f = 100 MHz, VDD = 3.3V or 2.5V
		–	1.2	1.7	ps	f = 156.25 MHz, VDD = 3.3V or 2.5V
		–	1.2	1.7	ps	f = 212.5 MHz, VDD = 3.3V or 2.5V
<b>RMS Phase Jitter (random)</b>	T <sub>phj</sub>	–	0.6	0.85	ps	f = 156.25 MHz, Integration bandwidth = 12 kHz to 20 MHz, all V <sub>dds</sub>

**Table 2. Pin Description**

Pin	Map		Functionality
1	NC	NA	No Connect; Leave it floating or connect to GND for better heat dissipation
	OE	Input	H or Open: specified frequency output L: output is high impedance
	$\overline{ST}$	Input	H or Open: specified frequency output L: Device goes to sleep mode. Supply current reduces to I <sub>std</sub> .
2	NC	NA	No Connect; Leave it floating or connect to GND for better heat dissipation
3	GND	Power	VDD Power Supply Ground
4	OUT+	Output	Oscillator output
5	OUT-	Output	Complementary oscillator output
6	VDD	Power	Power supply voltage

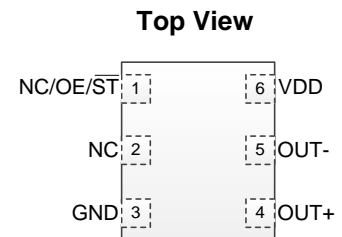

**Figure 1. Pin Assignments**

**Table 3. Absolute Maximum Limits**

Attempted operation outside the absolute maximum ratings of the part may cause permanent damage to the part. Actual performance of the IC is only guaranteed within the operational specifications, not at absolute maximum ratings.

Parameter	Min.	Max.	Unit
Storage Temperature	-65	150	°C
VDD	-0.5	4	V
Electrostatic Discharge (HBM)	–	2000	V
Soldering Temperature (follow standard Pb free soldering guidelines)	–	260	°C

**Table 4. Thermal Consideration<sup>[1]</sup>**

Package	$\theta_{JA}$ , 4 Layer Board (°C/W)	$\theta_{JC}$ , Bottom (°C/W)
7050, 6-pin	142	27
5032, 6-pin	97	20
3225, 6-pin	109	20

Note:

1. Refer to JESD51-7 for  $\theta_{JA}$  and  $\theta_{JC}$  definitions, and reference layout used to determine the  $\theta_{JA}$  and  $\theta_{JC}$  values in the above table.

**Table 5. Maximum Operating Junction Temperature<sup>[2]</sup>**

Max Operating Temperature (ambient)	Maximum Operating Junction Temperature
70°C	90°C
85°C	105°C

Note:

2. Datasheet specifications are not guaranteed if junction temperature exceeds the maximum operating junction temperature.

**Table 6. Environmental Compliance**

Parameter	Condition/Test Method
Mechanical Shock	MIL-STD-883F, Method 2002
Mechanical Vibration	MIL-STD-883F, Method 2007
Temperature Cycle	JESD22, Method A104
Solderability	MIL-STD-883F, Method 2003
Moisture Sensitivity Level	MSL1 @ 260°C

## Waveform Diagrams

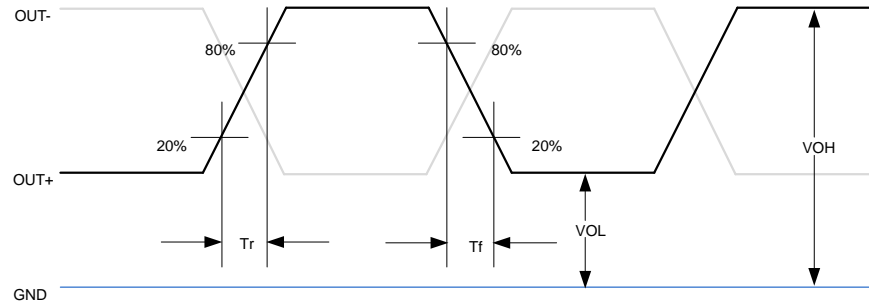

**Figure 1(a). LVPECL Voltage Levels per Differential Pin (i.e. OUT+, or OUT-)**

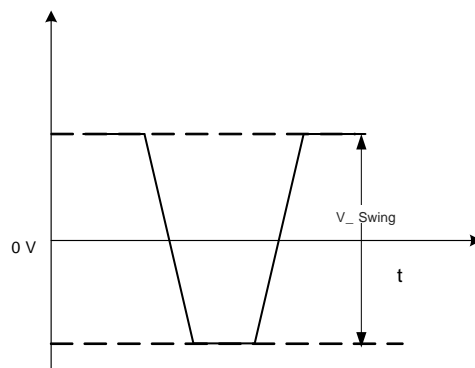

**Figure 1(b). LVPECL Voltage Levels Across Differential Pair (i.e. OUT+ minus OUT-)**

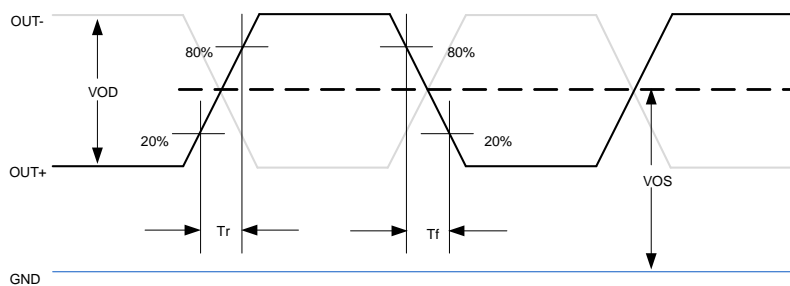

**Figure 2. LVDS Voltage Levels per Differential Pin (i.e. OUT+, or OUT-)**

## Termination Diagrams

### LVPECL



**Figure 3. LVPECL Typical Termination**

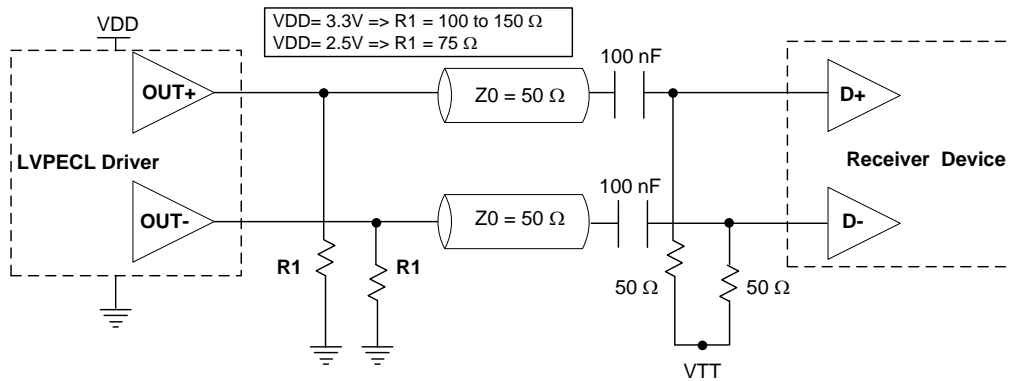

**Figure 4. LVPECL AC Coupled Termination**

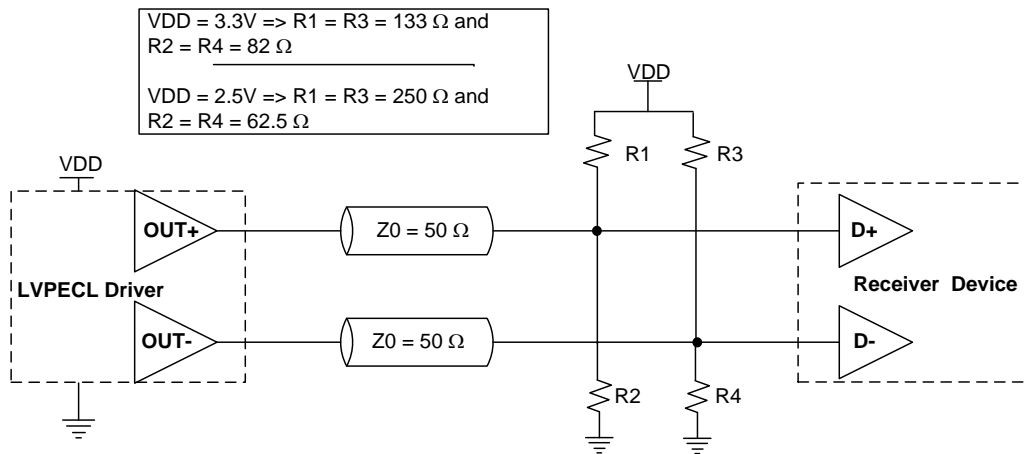

**Figure 5. LVPECL with Thevenin Typical Termination**

### Termination Diagrams (continued)

#### LVDS

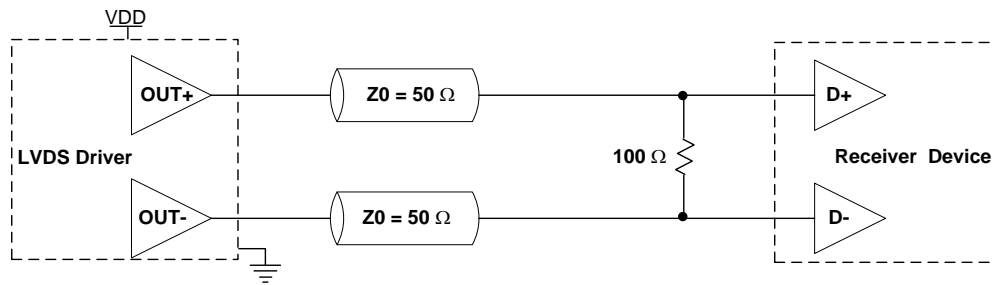

**Figure 6. LVDS Single Termination (Load Terminated)**

### Dimensions and Patterns

Package Size – Dimensions (Unit: mm) <sup>(3)</sup>	Recommended Land Pattern (Unit: mm) <sup>(4)</sup>
<p><b>3.2 x 2.5 x 0.75 mm</b></p>	
<p><b>5.0 x 3.2 x 0.75 mm</b></p>	
<p><b>7.0 x 5.0 x 0.90 mm</b></p>	

**Notes:**

3. Top Marking: Y denotes manufacturing origin and XXXX denotes manufacturing lot number. The value of “Y” will depend on the assembly location of the device.
4. A capacitor of value 0.1  $\mu$ F between VDD and GND is recommended.

### Ordering Information

**SiT9121AC-1 C2-33E 125.000000T**

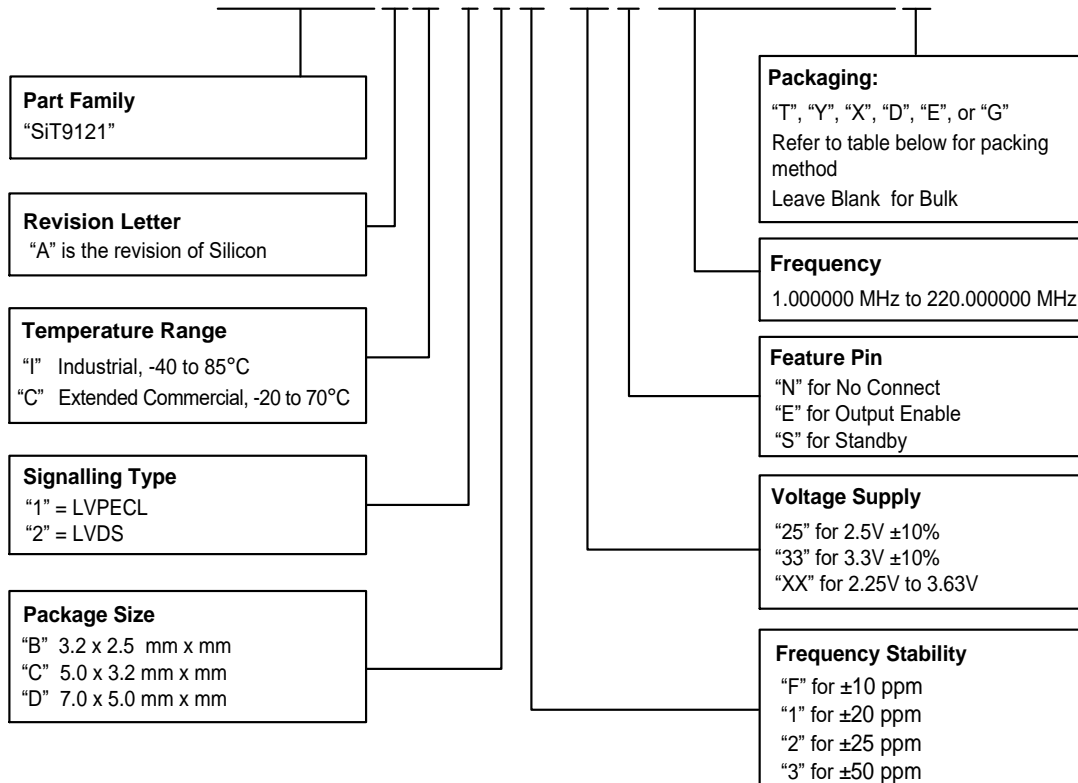

**Table 7. Frequencies Not Supported**

Frequency Range	
Min.	Max.
209.000001 MHz	210.999999 MHz

**Table 8. Ordering Codes for Supported Tape & Reel Packing Method**

Device Size	8 mm T&R (3ku)	8 mm T&R (1ku)	8 mm T&R (250u)	12 mm T&R (3ku)	12 mm T&R (1ku)	12 mm T&R (250u)	16 mm T&R (3ku)	16 mm T&R (1ku)	16 mm T&R (250u)
7.0 x 5.0 mm	-	-	-	-	-	-	T	Y	X
5.0 x 3.2 mm	-	-	-	T	Y	X	-	-	-
3.2 x 2.5 mm	D	E	G	T	Y	X	-	-	-

Table 9. Revision History

Revisions	Release Date	Change Summary
1.01	02/20/2013	Original
1.02	12/03/2013	Added input specifications, LVPECL/LVDS waveforms, packaging T&R options
1.03	02/06/2014	Added 8mm T&R option and $\pm 10$ ppm
1.04	04/08/2014	Included 1.8V option for LVDS output only
1.05	07/30/2014	Included Thermal Consideration table
1.06	10/20/2014	Modified Thermal Consideration values. Preliminary removed from the title
1.07	04/03/2017	Removed 1.8V option
1.08	08/17/2019	Added No Connect feature to Pin 1 Added Table 5: Maximum Operating Junction Temperature Updated logo and company address, other page layout changes

**SiTime Corporation, 5451 Patrick Henry Drive, Santa Clara, CA 95054, USA | Phone: +1-408-328-4400 | Fax: +1-408-328-4439**

© SiTime Corporation 2013-2019. The information contained herein is subject to change at any time without notice. SiTime assumes no responsibility or liability for any loss, damage or defect of a Product which is caused in whole or in part by (i) use of any circuitry other than circuitry embodied in a SiTime product, (ii) misuse or abuse including static discharge, neglect or accident, (iii) unauthorized modification or repairs which have been soldered or altered during assembly and are not capable of being tested by SiTime under its normal test conditions, or (iv) improper installation, storage, handling, warehousing or transportation, or (v) being subjected to unusual physical, thermal, or electrical stress.

**Disclaimer:** SiTime makes no warranty of any kind, express or implied, with regard to this material, and specifically disclaims any and all express or implied warranties, either in fact or by operation of law, statutory or otherwise, including the implied warranties of merchantability and fitness for use or a particular purpose, and any implied warranty arising from course of dealing or usage of trade, as well as any common-law duties relating to accuracy or lack of negligence, with respect to this material, any SiTime product and any product documentation. Products sold by SiTime are not suitable or intended to be used in a life support application or component, to operate nuclear facilities, or in other mission critical applications where human life may be involved or at stake. All sales are made conditioned upon compliance with the critical uses policy set forth below.

#### CRITICAL USE EXCLUSION POLICY

BUYER AGREES NOT TO USE SITIME'S PRODUCTS FOR ANY APPLICATION OR IN ANY COMPONENTS USED IN LIFE SUPPORT DEVICES OR TO OPERATE NUCLEAR FACILITIES OR FOR USE IN OTHER MISSION-CRITICAL APPLICATIONS OR COMPONENTS WHERE HUMAN LIFE OR PROPERTY MAY BE AT STAKE.

SiTime owns all rights, title and interest to the intellectual property related to SiTime's products, including any software, firmware, copyright, patent, or trademark. The sale of SiTime products does not convey or imply any license under patent or other rights. SiTime retains the copyright and trademark rights in all documents, catalogs and plans supplied pursuant to or ancillary to the sale of products or services by SiTime. Unless otherwise agreed to in writing by SiTime, any reproduction, modification, translation, compilation, or representation of this material shall be strictly prohibited.

# Supplemental Information

The Supplemental Information section is not part of the datasheet and is for informational purposes only.

## Best Reliability

Silicon is inherently more reliable than quartz. Unlike quartz suppliers, SiTime has in-house MEMS and analog CMOS expertise, which allows SiTime to develop the most reliable products. Figure 1 shows a comparison with quartz technology.

### Why is SiTime Best in Class:

- SiTime's MEMS resonators are vacuum sealed using an advanced EpiSeal™ process, which eliminates foreign particles and improves long term aging and reliability
- World-class MEMS and CMOS design expertise

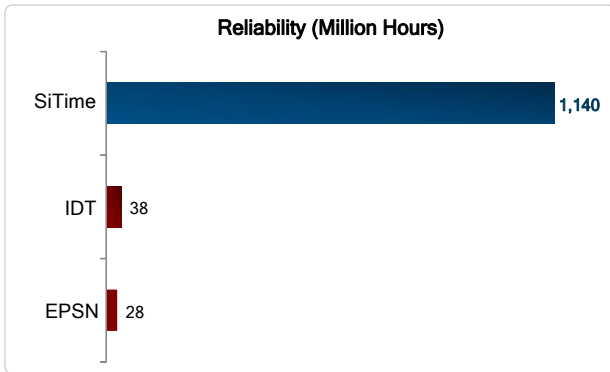

Figure 1. Reliability Comparison<sup>[1]</sup>

## Best Aging

Unlike quartz, MEMS oscillators have excellent long term aging performance which is why every new SiTime product specifies 10-year aging. A comparison is shown in Figure 2.

### Why is SiTime Best in Class:

- SiTime's MEMS resonators are vacuum sealed using an advanced EpiSeal™ process, which eliminates foreign particles and improves long term aging and reliability
- Inherently better immunity of electrostatically driven MEMS resonator

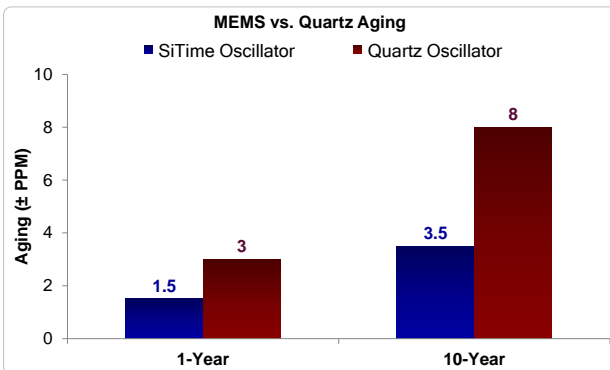

Figure 2. Aging Comparison<sup>[2]</sup>

## Best Electro Magnetic Susceptibility (EMS)

SiTime's oscillators in plastic packages are up to 54 times more immune to external electromagnetic fields than quartz oscillators as shown in Figure 3.

### Why is SiTime Best in Class:

- Internal differential architecture for best common mode noise rejection
- Electrostatically driven MEMS resonator is more immune to EMS

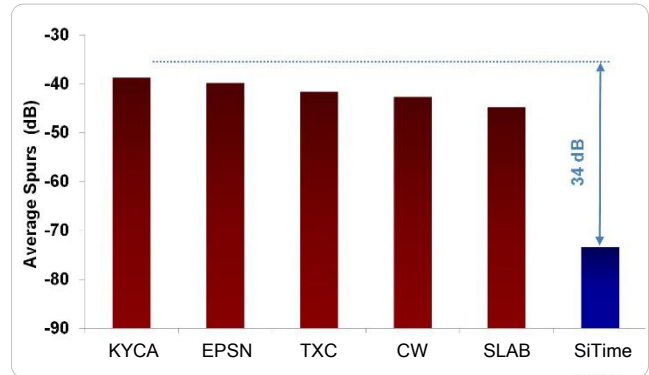

Figure 3. Electro Magnetic Susceptibility (EMS)<sup>[3]</sup>

## Best Power Supply Noise Rejection

SiTime's MEMS oscillators are more resilient against noise on the power supply. A comparison is shown in Figure 4.

### Why is SiTime Best in Class:

- On-chip regulators and internal differential architecture for common mode noise rejection
- MEMS resonator is paired with advanced analog CMOS IC

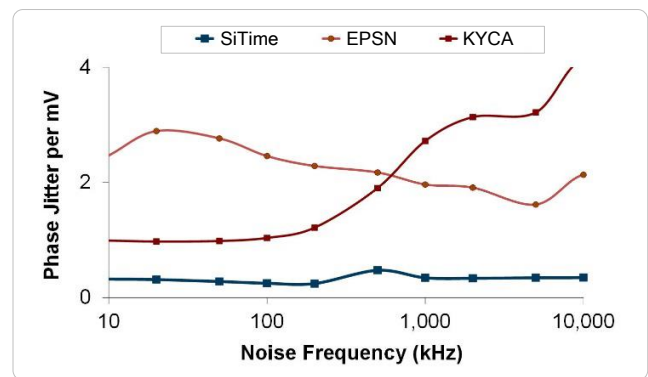

Figure 4. Power Supply Noise Rejection<sup>[4]</sup>

## Best Vibration Robustness

High-vibration environments are all around us. All electronics, from handheld devices to enterprise servers and storage systems are subject to vibration. Figure 5 shows a comparison of vibration robustness.

### Why is SiTime Best in Class:

- The moving mass of SiTime’s MEMS resonators is up to 3000 times smaller than quartz
- Center-anchored MEMS resonator is the most robust design

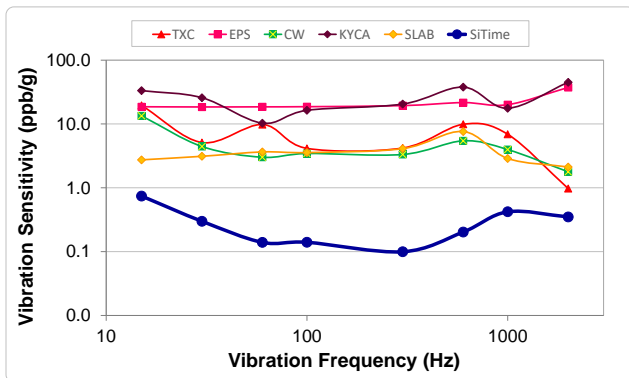

Figure 5. Vibration Robustness<sup>[5]</sup>

### Figure labels:

- TXC = TXC
- Epson = EPSN
- Connor Winfield = CW
- Kyocera = KYCA
- SiLabs = SLAB
- SiTime = EpiSeal MEMS

## Best Shock Robustness

SiTime’s oscillators can withstand at least 50,000 g shock. They all maintain their electrical performance in operation during shock events. A comparison with quartz devices is shown in Figure 6.

### Why is SiTime Best in Class:

- The moving mass of SiTime’s MEMS resonators is up to 3000 times smaller than quartz
- Center-anchored MEMS resonator is the most robust design

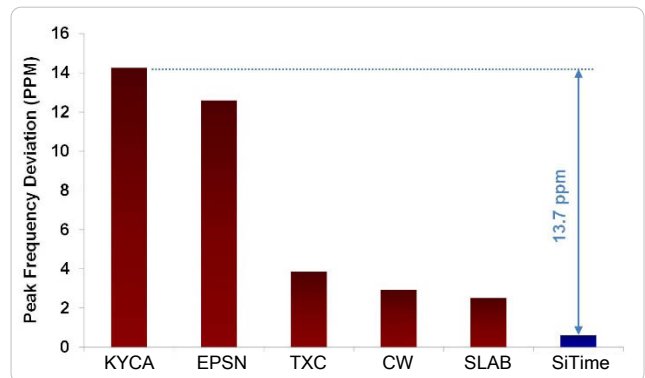

Figure 6. Shock Robustness<sup>[6]</sup>

**Notes:**

1. Data source: Reliability documents of named companies.
2. Data source: SiTime and quartz oscillator devices datasheets.
3. Test conditions for Electro Magnetic Susceptibility (EMS):
  - According to IEC EN61000-4.3 (Electromagnetic compatibility standard)
  - Field strength: 3V/m
  - Radiated signal modulation: AM 1 kHz at 80% depth
  - Carrier frequency scan: 80 MHz – 1 GHz in 1% steps
  - Antenna polarization: Vertical
  - DUT position: Center aligned to antenna

**Devices used in this test:**

Label	Manufacturer	Part Number	Technology
EpiSeal MEMS	SiTime	SiT9120AC-1D2-33E156.250000	MEMS + PLL
EPSN	Epson	EG-2102CA156.2500M-PHPAL3	Quartz, SAW
TXC	TXC	BB-156.250MBE-T	Quartz, 3 <sup>rd</sup> Overtone
CW	Conner Winfield	P123-156.25M	Quartz, 3 <sup>rd</sup> Overtone
KYCA	AVX Kyocera	KC7050T156.250P30E00	Quartz, SAW
SLAB	SiLab	590AB-BDG	Quartz, 3 <sup>rd</sup> Overtone + PLL

4. 50 mV pk-pk Sinusoidal voltage.

**Devices used in this test:**

Label	Manufacturer	Part Number	Technology
EpiSeal MEMS	SiTime	SiT8208AI-33-33E-25.000000	MEMS + PLL
NDK	NDK	NZ2523SB-25.6M	Quartz
KYCA	AVX Kyocera	KC2016B25M0C1GE00	Quartz
EPSN	Epson	SG-310SCF-25M0-MB3	Quartz

5. Devices used in this test:  
same as EMS test stated in Note 3.
6. Test conditions for shock test:
  - MIL-STD-883F Method 2002
  - Condition A: half sine wave shock pulse, 500-g, 1ms
  - Continuous frequency measurement in 100  $\mu$ s gate time for 10 seconds

**Devices used in this test:**

same as EMS test stated in Note 3.

7. Additional data, including setup and detailed results, is available upon request to qualified customer. Please contact [productsupport@sitime.com](mailto:productsupport@sitime.com).

## Looking for pricing, stock, or lifecycle information?

Click below to explore more details on WIN SOURCE:

 [View SIT9121AC-1D3-33E187.500000 on WIN SOURCE](#)

 [SiTIME Information](#)

## Optimize Your Supply Chain with WIN SOURCE Solutions

-  Global Sourcing Solution
-  Obsolete Management
-  Cost Control Management
-  Shortage Management
-  Alternative Solution
-  Excess Inventory Management