



THE DATASHEET OF S6X8ES2



SxX8xSx Series
EV Series 0.8 A Sensitive SCRs



Agency Approvals and Environmental

Environmental Approvals

RoHS **HF**

Product Summary

| Characteristic | Value | Unit |
|---------------------|------------------|---------|
| $I_{T(RMS)}$ | 0.8 | A |
| V_{DRM} / V_{RRM} | 400, 600, or 800 | V |
| I_{GT} | 5 to 200 | μA |

Schematic Symbol

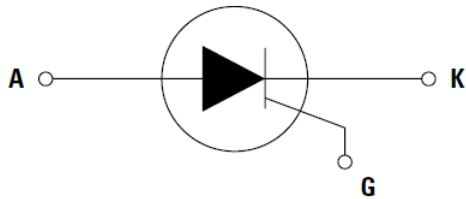

Product Description

This new component series offers high static dv/dt and low turn off time (t_q) sensitive SCR. It is specifically designed for Ground Fault Circuit Interrupter (GFCI) and Gas Ignition applications. All SCRs junctions are glass-passivated to ensure long term reliability and parametric stability.

Features

- Surge capability > 10 A
- Blocking voltage (V_{DRM} / V_{RRM}) capability up to 800 V
- High dv/dt noise immunity
- Improved turn-off time (t_q) < 25 μsec
- Sensitive gate for direct microprocessor interface
- Through-hole and surface-mount packages
- RoHS compliant and Halogen-Free

Applications

The SxX8xSx EV series is specifically designed for Ground Fault Circuit Interrupter (GFCI) and gas ignition applications.

- 1. Maximum Ratings.....3
- 2. Thermal Characteristics3
- 3. Electrical Characteristics ($T_J = 25\text{ }^\circ\text{C}$ unless otherwise specified)3
- 4. Static Characteristics ($T_J = 25\text{ }^\circ\text{C}$ unless otherwise specified).....3
- 5. Performance Curves4
- 6. Soldering Parameters7
- 7. Physical Specifications.....7
- 8. Environmental Specifications.....7
- 9. Design Considerations.....8
- 10. Package Dimensions9
- 11. Part Numbering and Marking.....10
- 12. Product Selector11
- 13. Packing Options.....11
- 14. Packing Specifications11

1. Maximum Ratings

| Symbol | Characteristic | Conditions | | Value | Unit |
|--------------|--|-------------------------------|-----------------------------------|------------|------------------------|
| $I_{T(RMS)}$ | RMS On-state Current (Full Sine Wave) | TO-92 | $T_C = 55\text{ }^\circ\text{C}$ | 0.8 | A |
| | | SOT-89 | $T_C = 60\text{ }^\circ\text{C}$ | | |
| | | SOT-223 | $T_L = 60\text{ }^\circ\text{C}$ | | |
| $I_{T(AV)}$ | Average On-state Current | TO-92 | $T_C = 55\text{ }^\circ\text{C}$ | 0.51 | A |
| | | SOT-89 | $T_C = 60\text{ }^\circ\text{C}$ | | |
| | | SOT-223 | $T_L = 60\text{ }^\circ\text{C}$ | | |
| I_{TSM} | Non-repetitive Surge Peak On-state Current (Single Cycle, $T_{J,Initial} = 25\text{ }^\circ\text{C}$) | TO-92 | $f = 50\text{ Hz}$ | 8 | A |
| | | SOT-89 | $f = 60\text{ Hz}$ | 10 | |
| | | SOT-223 | | | |
| I^2t | I^2t Value for Fusing | $t_p = 10\text{ ms}$ | $f = 50\text{ Hz}$ | 0.32 | A^2s |
| | | $t_p = 8.3\text{ ms}$ | $f = 60\text{ Hz}$ | 0.41 | |
| di/dt | Critical Rate of Rise of On-state Current $I_G = 10\text{ mA}$ | TO-92 SOT-89 SOT-223 | $T_J = 125\text{ }^\circ\text{C}$ | 50 | $\text{A}/\mu\text{s}$ |
| I_{GM} | Peak Gate Current | $t_p = 10\text{ }\mu\text{s}$ | $T_J = 125\text{ }^\circ\text{C}$ | 1.0 | A |
| $P_{G(AV)}$ | Average Gate Power Dissipation | - | $T_J = 125\text{ }^\circ\text{C}$ | 0.1 | W |
| T_{STG} | Storage Junction Temperature Range | - | - | -40 to 150 | $^\circ\text{C}$ |
| T_J | Operating Junction Temperature Range | - | - | -40 to 125 | $^\circ\text{C}$ |

2. Thermal Characteristics

| Symbol | Characteristic | Conditions | Value | Unit | |
|--------------|---|--------------------------------|---------|------|---------------------------|
| $R_{th(JC)}$ | Thermal Resistance, junction-to-case (AC) | $I_T = 0.8\text{ A}_{(RMS)}^1$ | TO-92 | 75 | $^\circ\text{C}/\text{W}$ |
| | | | SOT-223 | 30 | |
| | | | SOT-89 | 50 | |
| $R_{th(JA)}$ | Thermal Resistance, junction-to-ambient | $I_T = 0.8\text{ A}_{(RMS)}^1$ | TO-92 | 150 | $^\circ\text{C}/\text{W}$ |
| | | | SOT-223 | 60 | |
| | | | SOT-89 | 90 | |

Note 1: 60 Hz AC resistive load condition, 100% conduction

3. Electrical Characteristics ($T_J = 25\text{ }^\circ\text{C}$ unless otherwise specified)

| Symbol | Description | Conditions | SxX8yS1 | | | SxX8yS2 | | | SxX8yS | | | Unit |
|-------------|--|--|---------|-----|-----|---------|-----|-----|--------|-----|-----|------------------------|
| | | | Min | Typ | Max | Min | Typ | Max | Min | Typ | Max | |
| I_{GT} | DC Gate Trigger Current | $V_D = 6\text{ V}, R_L = 100\text{ }\Omega$ | 0.5 | - | 5 | 1 | - | 50 | 15 | - | 200 | μA |
| V_{GT} | DC Gate Trigger Voltage | $V_D = 6\text{ V}, R_L = 100\text{ }\Omega$ | - | - | 0.8 | - | - | 0.8 | - | - | 0.8 | V |
| V_{GRM} | Peak Reverse Gate Voltage | $I_{RG} = 10\text{ }\mu\text{A}$ | 5 | - | - | 5 | - | - | 5 | - | - | V |
| I_H | Holding Current | $R_{GK} = 1\text{ k}\Omega$, Initial current = 20 A | - | - | 5 | - | - | 5 | - | - | 5 | mA |
| $(dv/dt)_s$ | Critical Rate-of-rise of Off-stage Voltage | $T_J = 125\text{ }^\circ\text{C}, V_D = V_{DRM}/V_{RRM}$, $R_{GK} = 1\text{ k}\Omega$, Exponential waveform | 75 | - | - | 75 | - | - | 75 | - | - | $\text{V}/\mu\text{s}$ |
| t_q | Turn-off Time | $T_J = 25\text{ }^\circ\text{C} @ 600\text{ V}, R_{GK} = 1\text{ k}\Omega$ | - | - | 30 | - | - | 25 | - | - | 25 | μs |
| t_{gt} | Turn-on Time | $I_G = 10\text{ mA}, P_W = 15\text{ }\mu\text{s}, I_T = 1.6\text{ A}_{PK}$ | - | 2 | - | - | 2 | - | - | 2 | - | μs |
| V_{GD} | Gate Non-trigger Voltage | $V_D = V_{DRM}, R_{GK} = 1\text{ k}\Omega, T_J = 125\text{ }^\circ\text{C}$ | 0.2 | - | - | 0.2 | - | - | 0.2 | - | - | V |

Note: x = voltage /100, y = package

4. Static Characteristics ($T_J = 25\text{ }^\circ\text{C}$ unless otherwise specified)

| Symbol | Description | Conditions | Value | | Unit |
|-----------|------------------------------------|--|-------|------|---------------|
| | | | Min | Max | |
| V_{TM} | Peak On-state Voltage | $I_{TM} = 1.6\text{ A}_{PK}$ | - | 1.70 | V |
| I_{DRM} | Off-state Current, Peak Repetitive | $T_J = 25\text{ }^\circ\text{C} @ V_D = V_{DRM}, R_{GK} = 1\text{ k}\Omega$ | - | 3 | μA |
| | | $T_J = 125\text{ }^\circ\text{C} @ V_D = V_{DRM}, R_{GK} = 1\text{ k}\Omega$ | - | 500 | |

5. Performance Curves

Figure 1. Normalized DC Gate Trigger Current for All Quadrants vs. Junction Temperature

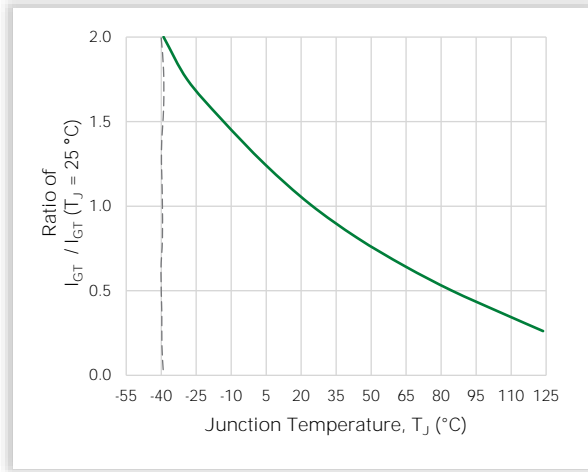

Figure 2. Normalized DC Holding Current vs. Junction Temperature

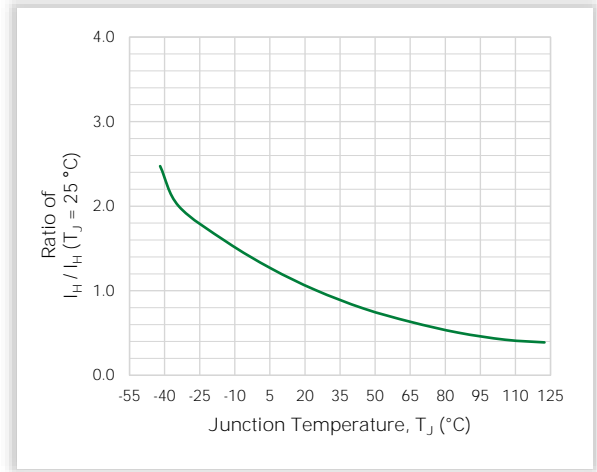

Figure 3. Normalized DC Gate Trigger Voltage vs. Junction Temperature

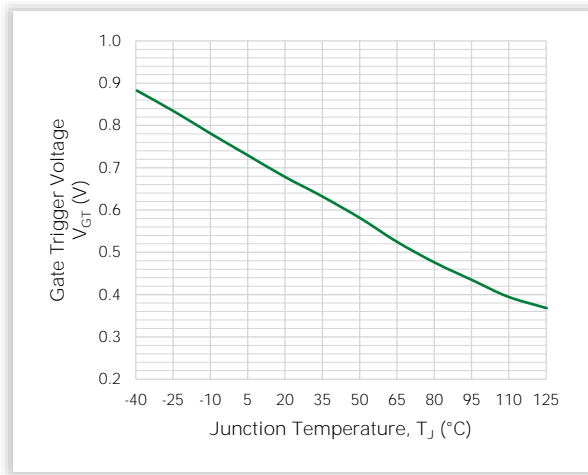

Figure 4. Typical On-state Current vs. On-state Voltage

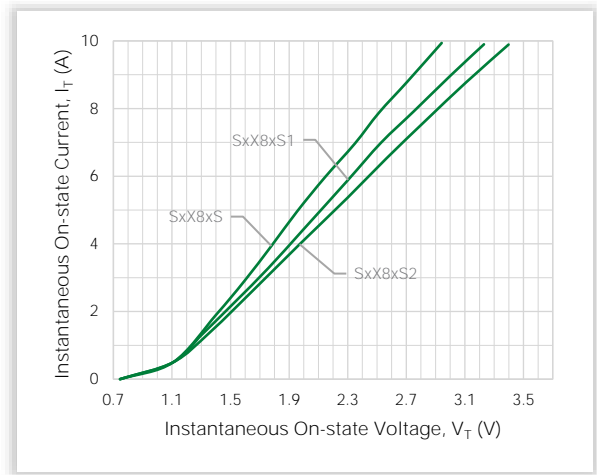

Figure 5. Typical Power Dissipation vs. RMS On-state Current



Figure 6. Maximum Allowable Case Temperature vs. On-state Current



Figure 7. Typical DC Gate Trigger Current with R_{GK} vs. Junction Temperature for S6X8xS



Figure 8. Typical DC Gate Trigger Current with R_{GK} vs. Junction Temperature for S8X8xS



Figure 9. Typical DC Holding Current with R_{GK} vs. Junction Temperature for S6X8xS



Figure 10. Typical DC Holding Current with R_{GK} vs. Junction Temperature for S8X8xS



Figure 11. Typical DC Static dv/dt with R_{GK} vs. Junction Temperature for S6X8xS

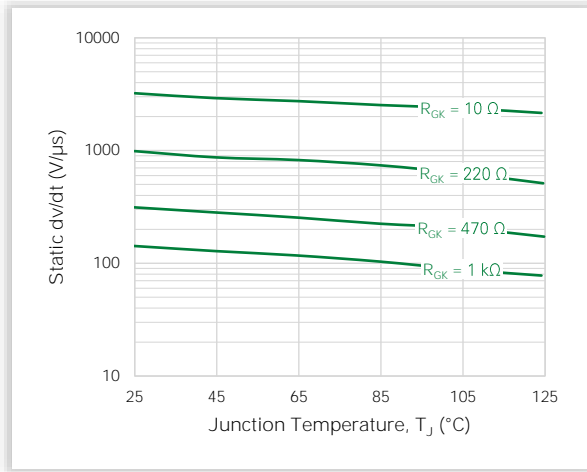

Figure 12. Typical DC Static dv/dt with R_{GK} vs. Junction Temperature for S8X8xS

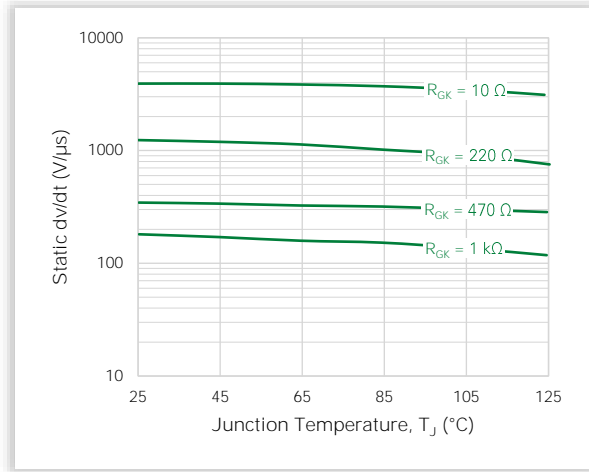

Figure 13. Typical DC Turn-off Time with R_{GK} vs. Junction Temperature for S6X8xS

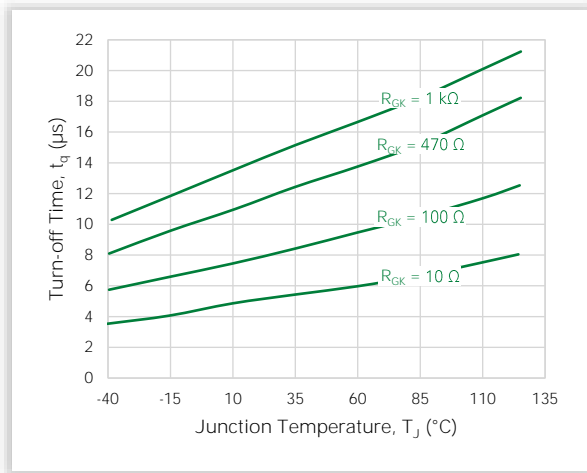

Figure 14. Typical DC Turn-off Time with R_{GK} vs. Junction Temperature for S8X8xS

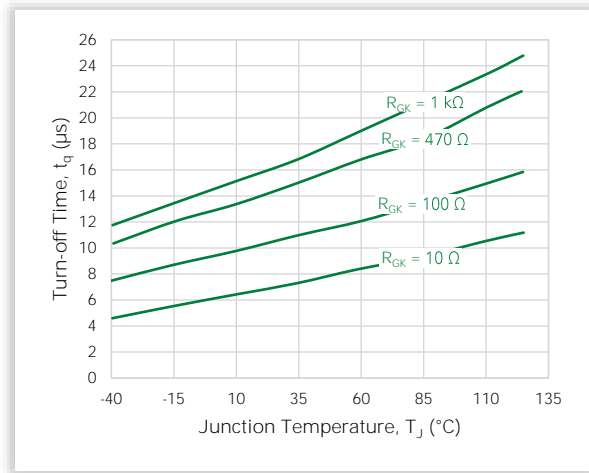

Figure 15. Surge Peak On-state Current vs. Number of Cycles



Notes

1. Gate control may be lost during and immediately following surge current interval.
2. Overload may not be repeated until junction temperature has returned to steady-state rated value.

Figure 16. Peak Repetitive Sinusoidal Pulse Current



6. Soldering Parameters



| Parameter | Value | |
|--|-------------------------------|----------------------|
| Reflow Condition | Pb-free Assembly | |
| Pre-Heat | Temperature Min, $T_{S(Min)}$ | 150 °C |
| | Temperature Max, $T_{S(Max)}$ | 200 °C |
| | Time (Min to Max), t_s | 60 to 180 s |
| Average Ramp-up Rate Liquidus Temp., T_L to peak | | 5 °C/s (Max) |
| $T_{S(Max)}$ to T_L Ramp-up Rate | | 5 °C/s (Max) |
| Reflow | Temperature, T_L Liquidus | 217 °C |
| | Time, t_s | 60 to 150 s |
| Peak Temperature, T_P | | 260 °C (± 5 °C) |
| Time within 5 °C of Actual Peak Temperature, t_P | | 20 to 40 s |
| Ramp-down Rate | | 5 °C/s (Max) |
| Time 25 °C to Peak Temperature, T_P | | 8 minutes (Max) |
| Do Not Exceed | | 280 °C |

7. Physical Specifications

| Device Feature | Detail |
|-----------------|--|
| Terminal Finish | 100% Matte Tin-plated |
| Body Material | UL Recognized Compound meeting Flammability Rating V-0 |
| Lead Material | Copper Alloy |

8. Environmental Specifications

| Test | Specifications and Conditions |
|---------------------------|---|
| AC Blocking | MIL-STD-750, M-1040, Cond A Applied Peak AC voltage @ 110°C for 1008 hours |
| Temperature Cycling | MIL-STD-750, M-1051, 100 cycles: -40°C to +150°C; 15 min dwell time |
| Temperature/Humidity | EIA / JEDEC, JESD22-A101 1008 hours; 320V - DC; 85°C; 85% relative humidity |
| High-temp Storage | MIL-STD-750, M-1031, 1008 hours, 150°C |
| Low-temp Storage | 1008 hours, -40°C |
| Resistance to Solder Heat | MIL-STD-750 Method 2031 |
| Solderability | ANSI/J-STD-002, category 3, Test A |
| Lead Bend | MIL-STD-750, M-2036 Cond E |

9. Design Considerations

Careful selection of the correct component for the application's operating parameters and environment will go a long way toward extending the operating life of the Thyristor. Good design practice should limit the maximum continuous current through the main terminals to 75% of the component rating. Other ways to ensure long life for a power discrete semiconductor are proper heat sinking and selection of voltage ratings for worst case conditions. Overheating, overvoltage (including dv/dt), and surge currents are the main killers of semiconductors. Correct mounting, soldering, and forming of the leads also help protect against component damage.

10. Package Dimensions

TO-92

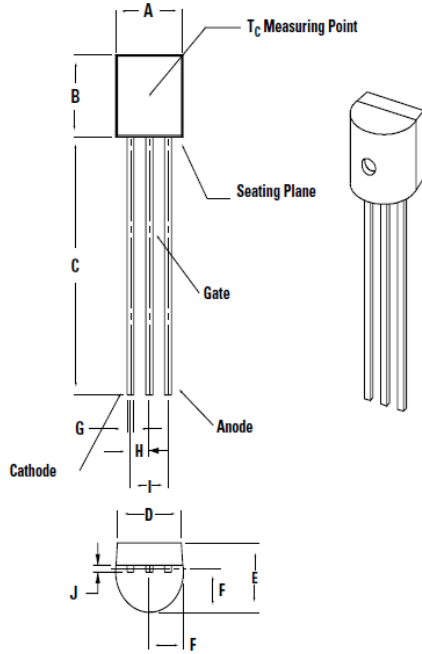

| Dimension | Millimeters | | Inches | |
|-----------|-------------|-------|--------|-------|
| | Min | Max | Min | Max |
| A | 4.450 | 5.200 | 0.175 | 0.205 |
| B | 4.320 | 5.330 | 0.170 | 0.210 |
| C | 12.700 | - | 0.500 | - |
| D | 3.430 | - | 0.135 | - |
| E | 3.180 | 4.190 | 0.125 | 0.165 |
| F | 2.040 | 2.660 | 0.080 | 0.105 |
| G | 0.407 | 0.533 | 0.016 | 0.021 |
| H | 1.150 | 1.390 | 0.045 | 0.055 |
| I | 2.420 | 2.660 | 0.095 | 0.105 |
| J | 0.380 | 0.500 | 0.015 | 0.020 |

SOT-223

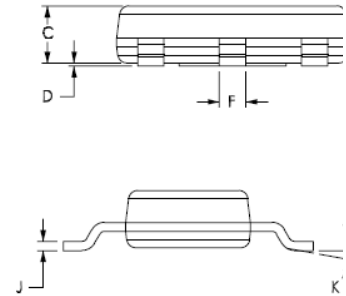

Pad Layout for SOT-223

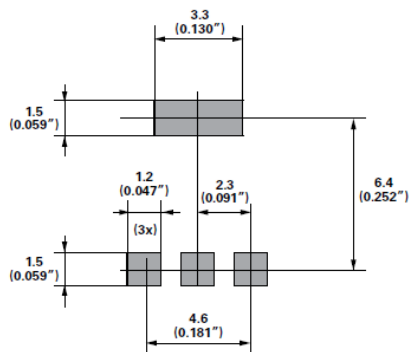

*Dimensions in millimeters (inches)

| Dimension | Millimeters | | | Inches | | |
|-----------|-------------|------|------|--------|-------|-------|
| | Min | Typ | Max | Min | Typ | Max |
| A | 6.30 | 6.50 | 6.70 | 0.248 | 0.256 | 0.264 |
| B | 3.30 | 3.50 | 3.70 | 0.130 | 0.138 | 0.146 |
| C | - | - | 1.80 | - | - | 0.071 |
| D | 0.02 | - | 0.10 | 0.001 | - | 0.004 |
| E | 2.90 | 3.00 | 3.15 | 0.114 | 0.118 | 0.124 |
| F | 0.60 | 0.70 | 0.85 | 0.024 | 0.027 | 0.034 |
| G | - | 2.30 | - | - | 0.090 | - |
| H | - | 4.60 | - | - | 0.181 | - |
| I | 6.70 | 7.00 | 7.30 | 0.264 | 0.276 | 0.287 |
| J | 0.24 | 0.26 | 0.35 | 0.009 | 0.010 | 0.014 |
| K | 10° MAX | | | | | |

SOT-89

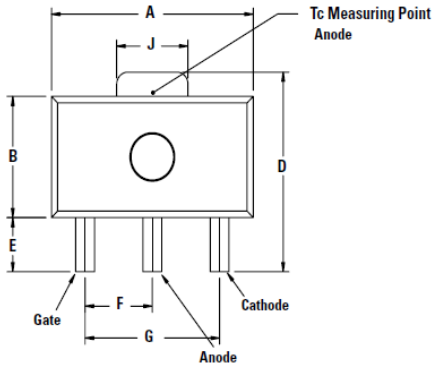

Pad Layout for SOT-89

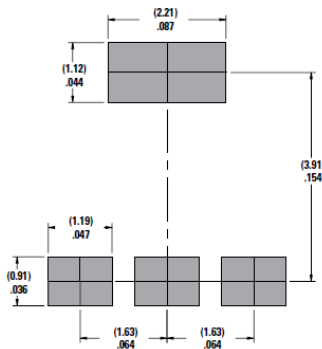

* Dimensions in millimeters (inches)

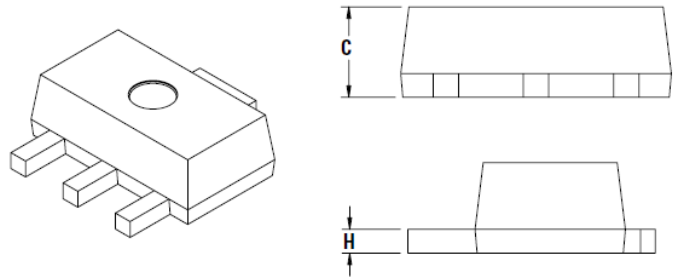

| Dimension | Millimeters | | | Inches | | |
|-----------|-------------|------|------|--------|-------|-------|
| | Min | Typ | Max | Min | Typ | Max |
| A | 4.40 | - | 4.60 | 0.173 | - | 0.181 |
| B | 2.29 | - | 2.60 | 0.090 | - | 0.102 |
| C | 1.40 | - | 1.60 | 0.055 | - | 0.063 |
| D | 3.94 | - | 4.25 | 0.155 | - | 0.167 |
| E | 0.81 | - | 1.20 | 0.032 | - | 0.047 |
| F | - | 1.50 | - | - | 0.059 | - |
| G | - | 3 | - | - | 0.118 | - |
| H | 0.35 | - | 0.44 | 0.014 | - | 0.017 |
| I | 0.36 | - | 0.48 | 0.014 | - | 0.019 |
| J | - | 1.65 | - | - | 0.065 | - |

11. Part Numbering and Marking

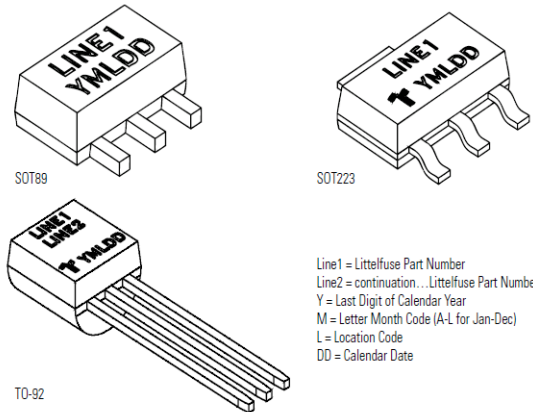
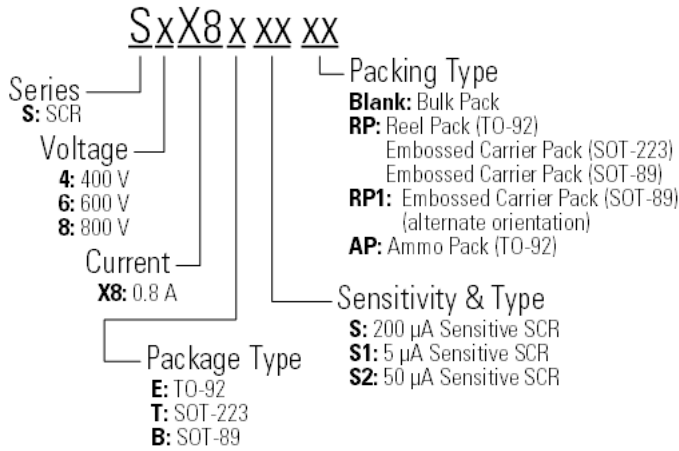

Line 1 = Littelfuse Part Number
Line 2 = continuation... Littelfuse Part Number
Y = Last Digit of Calendar Year
M = Letter Month Code (A-L for Jan-Dec)
L = Location Code
DD = Calendar Date

12. Product Selector

| Part Number | Voltage | | | Gate Sensitivity | Package |
|-------------|---------|-------|-------|------------------|---------|
| | 400 V | 600 V | 800 V | | |
| SxX8BS | X | X | - | 200 μ A | SOT-89 |
| SxX8ES | X | X | X | 200 μ A | TO-92 |
| SxX8TS | X | X | X | 200 μ A | SOT-223 |
| SxX8BS1 | X | X | - | 5 μ A | SOT-89 |
| SxX8ES1 | X | X | X | 5 μ A | TO-92 |
| SxX8TS1 | X | X | X | 5 μ A | SOT-223 |
| SxX8BS2 | X | X | - | 50 μ A | SOT-89 |
| SxX8ES2 | X | X | X | 50 μ A | TO-92 |
| SxX8TS2 | X | X | X | 50 μ A | SOT-223 |

13. Packing Options

| Part Number | Marking | Weight | Packing Mode | Base Quantity |
|-------------|---------|---------|--------------|---------------|
| SxX8ESy | SxX8ESy | 0.217 g | Bulk | 2500 |
| SxX8ESyAP | SxX8ESy | 0.217 g | Ammo Pack | 2000 |
| SxX8ESyRP | SxX8ESy | 0.217 g | Tape & Reel | 2000 |
| SxX8TSyRP | SxX8TSy | 0.120 g | Tape & Reel | 1000 |
| SxX8BSyRP | xX8y | 0.053 g | Tape & Reel | 1000 |
| SxX8BSyRP1 | xX8y | 0.053 g | Tape & Reel | 1000 |

Note: x = voltage/100, y = gate sensitivity

14. Packing Specifications

TO-92 (3-lead) Reel Pack (RP) Radial Leaded Specifications

Meets all EIA-468-C Standards

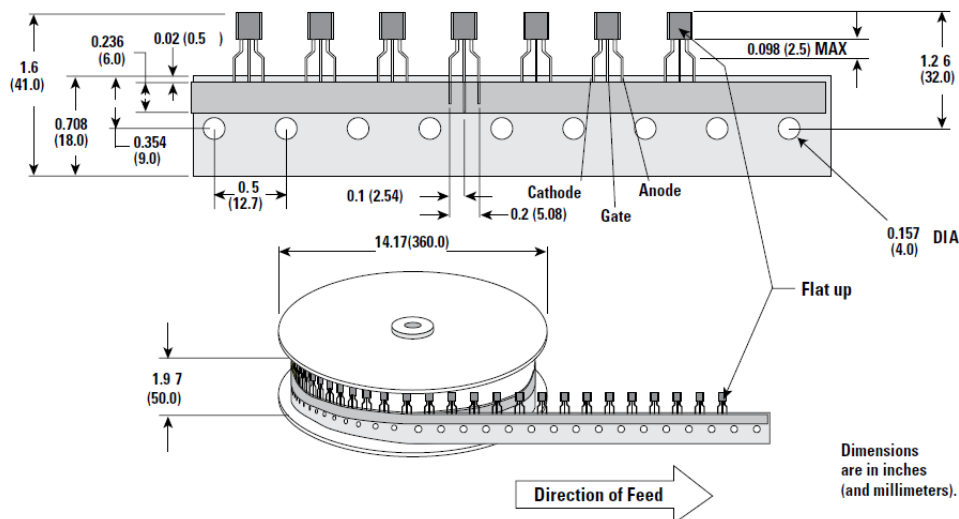

TO-92 (3-lead) Ammo Pack (AP) Radial Leaded Specifications

Meets all EIA-468-C Standards



SOT-89 Reel Pack (RP) Specifications



SOT-89 Reel Pack (RP1) Specifications

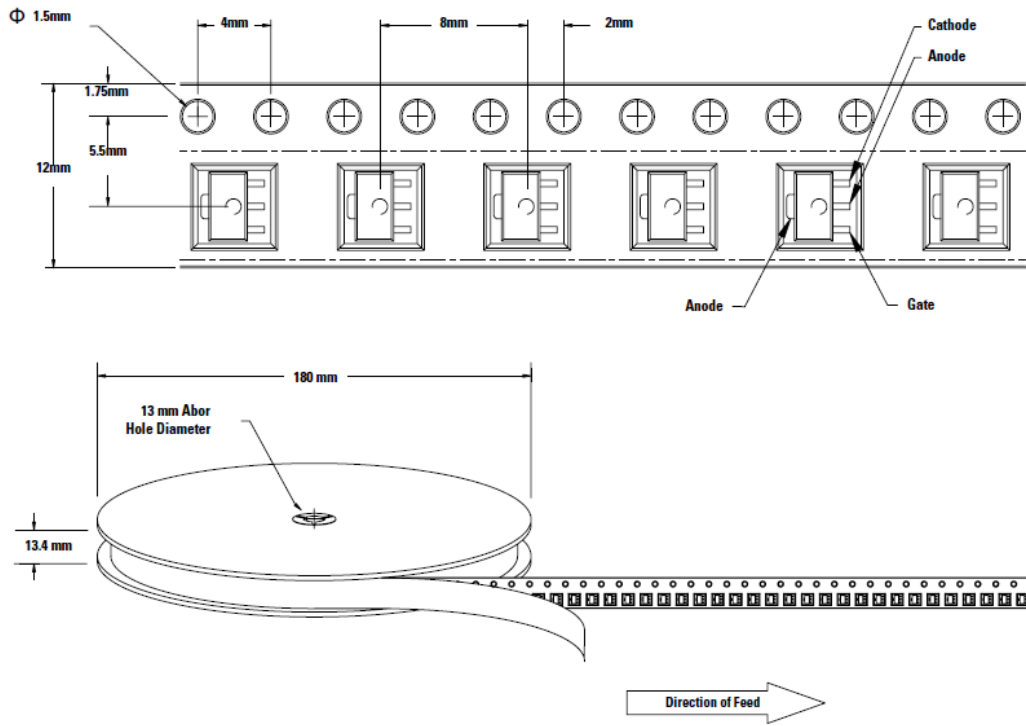

SOT-223 Reel Pack (RP) Specifications





For additional information please visit www.Littelfuse.com/powersemi

Disclaimer Notice - Littelfuse products are not designed for, and shall not be used for, any purpose (including, without limitation, automotive, military, aerospace, medical, life-saving, life-sustaining or nuclear facility applications, devices intended for surgical implant into the body, or any other application in which the failure or lack of desired operation of the product may result in personal injury, death, or property damage) other than those expressly forth in applicable Littelfuse product documentation. Littelfuse shall not be liable for any claims or damages arising out of products used in applications not expressly intended by Littelfuse as set forth in applicable Littelfuse documentation.

Read complete Disclaimer Notice at www.littelfuse.com/disclaimer-electronics

Looking for pricing, stock, or lifecycle information?

Click below to explore more details on WIN SOURCE:

-  [View S6X8ES2 on WIN SOURCE](#)
-  [Littelfuse Inc. Information](#)

Optimize Your Supply Chain with WIN SOURCE Solutions

-  Global Sourcing Solution
-  Obsolete Management
-  Cost Control Management
-  Shortage Management
-  Alternative Solution
-  Excess Inventory Management