



# THE DATASHEET OF S402TSRP



# Sx02xSx EV Series

## EV Series 1.5 Amp Sensitive SCRs

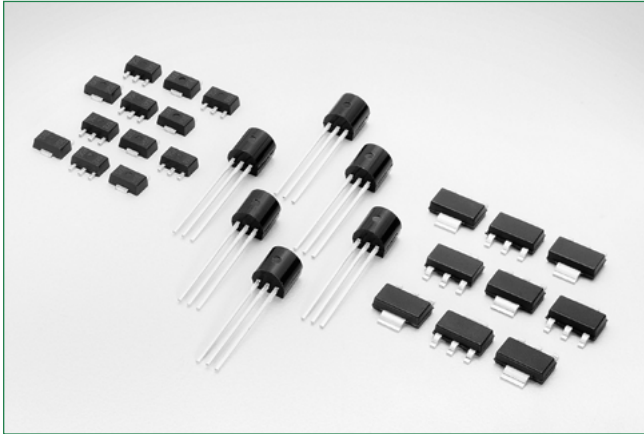
**HF** RoHS

### Additional Information



Resources



Accessories



Samples

### Main Features

Symbol	Value	Unit
$I_{T(RMS)}$	1.5	A
$V_{DRM}/V_{RRM}$	400 or 600	V
$I_{GT}$	200	$\mu$ A

### Description

This new 1.5A sensitive gate SCR component series offers high static dv/dt and low turn-off time (tq) All SCR junctions are glass-passivated to ensure long term reliability and parametric stability.

### Features

- Surge capability > 15Amps
- Blocking voltage (VDRM/VRRM) capability — up to 600V
- High dv/dt noise immunity
- Improved turn-off time (tq) < 35  $\mu$ sec.
- Sensitive gate for direct microprocessor interface
- Thru hole and surface mount packages
- RoHS compliant and Halogen-Free

### Applications

The Sx02xSx EV series is specifically designed for solenoid drive often seen in GFCI and similar safety cut-off devices.

### Schematic Symbol

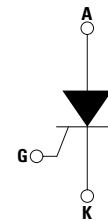

### Absolute Maximum Ratings

Symbol	Parameter	Value	Unit	
$I_{T(RMS)}$	RMS on-state current (full sine wave)	TO-92 $T_c = 65^\circ\text{C}$	1.5	A
		SOT-89 $T_c = 80^\circ\text{C}$		
		SOT-223 $T_c = 95^\circ\text{C}$		
$I_{T(AV)}$	Average on-state current	TO-92 $T_c = 65^\circ\text{C}$	0.95	A
		SOT-89 $T_c = 80^\circ\text{C}$		
		SOT-223 $T_c = 95^\circ\text{C}$		
$I_{TSM}$	Non repetitive surge peak on-state current (Single cycle, $T_j$ initial = $25^\circ\text{C}$ )	TO-92 $F = 50$ Hz	12.5	A
		SOT-89 $F = 60$ Hz	15.0	
		SOT-223		
$I^2t$	$I^2t$ Value for fusing	$t_p = 10$ ms $F = 50$ Hz	0.78	$\text{A}^2\text{s}$
		$t_p = 8.3$ ms $F = 60$ Hz	0.93	
di/dt	Critical rate of rise of on-state current $I_G = 10\text{mA}$	TO-92 $T_j = 125^\circ\text{C}$ SOT-89 $T_j = 125^\circ\text{C}$ SOT-223	50	$\text{A}/\mu\text{s}$
$I_{GM}$	Peak gate current	$t_p = 10$ $\mu\text{s}$ $T_j = 125^\circ\text{C}$	1.0	A
$P_{G(AV)}$	Average gate power dissipation	$T_j = 125^\circ\text{C}$	0.1	W
$T_{stg}$	Storage junction temperature range		-40 to 150	$^\circ\text{C}$
$T_j$	Operating junction temperature range		-40 to 125	$^\circ\text{C}$

# Sx02xSx EV Series

## EV Series 1.5 Amp Sensitive SCRs

### Electrical Characteristics (T<sub>J</sub> = 25°C, unless otherwise specified)

Symbol	Description	Test Conditions	Sx02xS		Sx02xS1		Sx02xS2		Units
			Min	Max	Min	Max	Min	Max	
I <sub>GT</sub>	DC Gate Trigger Current	V <sub>D</sub> = 12V; R <sub>L</sub> = 60 Ω	15	200	15	100	15	50	μA
V <sub>GT</sub>	DC Gate Trigger Voltage	V <sub>D</sub> = 12V; R <sub>L</sub> = 60 Ω	—	0.8	—	0.8	—	0.8	V
V <sub>GRRM</sub>	Peak Reverse Gate Voltage	I <sub>RG</sub> = 10μA	5	—	5	—	5	—	V
I <sub>H</sub>	Holding Current	R <sub>GK</sub> = 1 kΩ	—	5	—	3	—	3	mA
(dv/dt) <sub>s</sub>	"Critical Rate-of-Rise of Off-State Voltage"	"T <sub>J</sub> = 125°C V <sub>D</sub> = V <sub>DRM</sub> / V <sub>RPM</sub> Exponential Waveform R <sub>GK</sub> = 1 kΩ"	25	—	25	—	25	—	V/μs
t <sub>q</sub>	Turn-Off Time	"T <sub>J</sub> = 125°C @ 600 V R <sub>GK</sub> = 1 kΩ"	—	35	—	35	—	35	μs
t <sub>gt</sub>	Turn-On Time	"I <sub>G</sub> = 10mA PW = 15μsec I <sub>T</sub> = 3.0A (pk)"	—	3	—	3	—	3	μs
V <sub>GD</sub>	Gate Non-Trigger Voltage	"V <sub>D</sub> = V <sub>DRM</sub> , T <sub>J</sub> = 125°C, R <sub>L</sub> = 3.3kΩ"	0.2	—	0.2	—	0.2	—	V

x0 = voltage/10

### Static Characteristics (T<sub>J</sub> = 25°C, unless otherwise specified)

Symbol	Description	Test Conditions	Value		Unit
			Min	Max	
V <sub>TM</sub>	Peak On-State Voltage	I <sub>TM</sub> = 3.0A (pk)	—	1.70	V
I <sub>DRM</sub>	Off-State Current, Peak Repetitive	T <sub>J</sub> = 25°C @ V <sub>D</sub> = V <sub>DRM</sub> R <sub>GK</sub> = 1 kΩ	—	5	μA
		T <sub>J</sub> = 125°C @ V <sub>D</sub> = V <sub>DRM</sub> R <sub>GK</sub> = 1 kΩ	—	500	μA

### Thermal Resistances

Symbol	Parameter	Test Conditions	Value	Unit	
R <sub>θ(J-C)</sub>	Junction to case (AC)	I <sub>T</sub> = 1.5A <sub>(RMS)</sub> <sup>1</sup>	TO-92	50	°C/W
			SOT-89	35	
			SOT-223	25	
R <sub>θ(J-A)</sub>	Junction to ambient	I <sub>T</sub> = 1.5A <sub>(RMS)</sub> <sup>1</sup>	TO-92	160	°C/W
			SOT-89	90	
			SOT-223	60	

<sup>1</sup> 60Hz AC resistive load condition, 100% conduction.

# Sx02xSx EV Series

## EV Series 1.5 Amp Sensitive SCRs

**Figure 1: Normalized DC Gate Trigger Current vs. Junction Temperature**

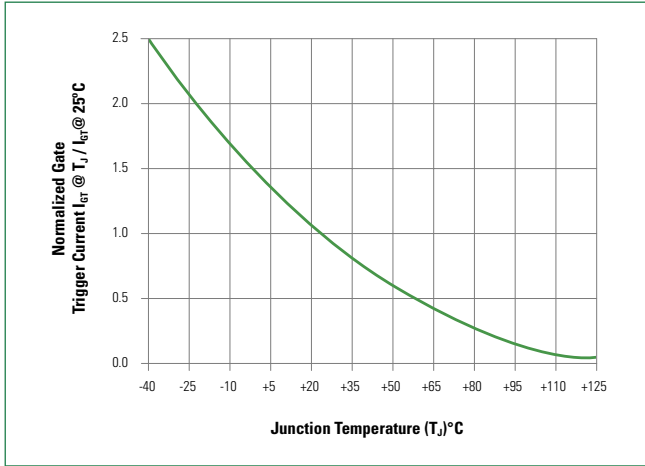

**Figure 2: Normalized DC Holding Current vs. Junction Temperature**

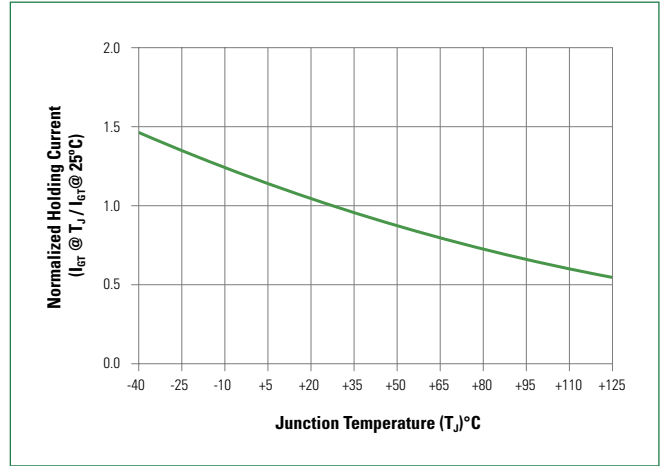

**Figure 3: Normalized DC Gate Trigger Voltage vs. Junction Temperature**

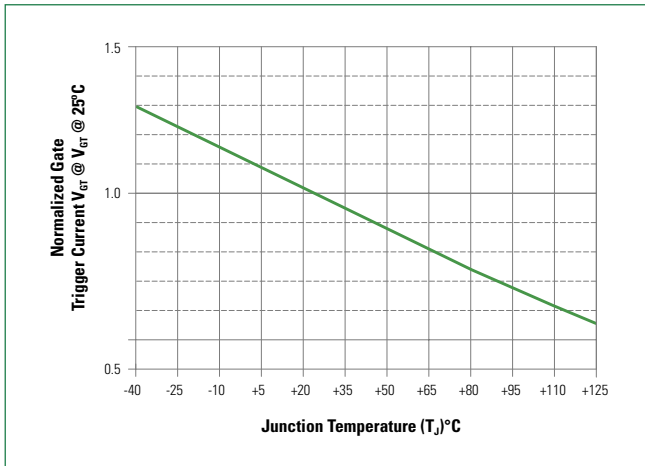

**Figure 4: On-State Current vs. On-State Voltage (Typical)**

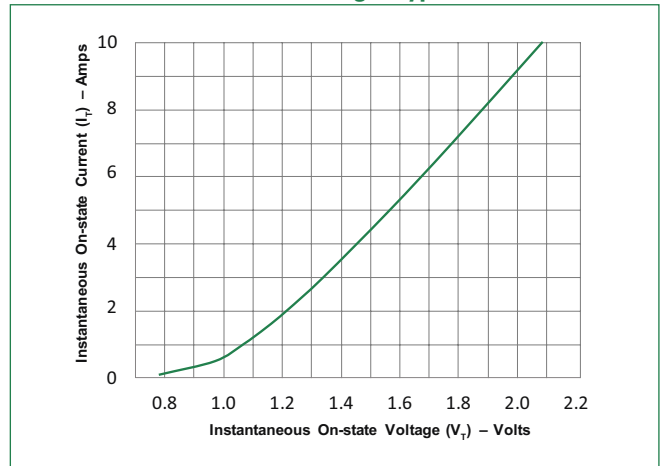

**Figure 5: Power Dissipation (Typical) vs. RMS On-State Current**

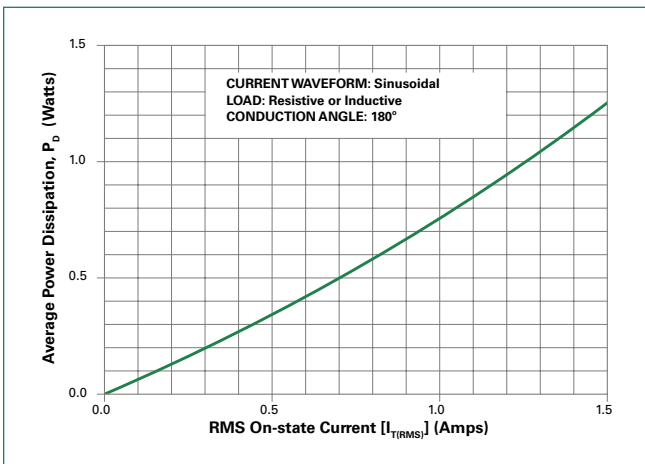

**Figure 6: Maximum Allowable Case Temperature vs. On-State Current**

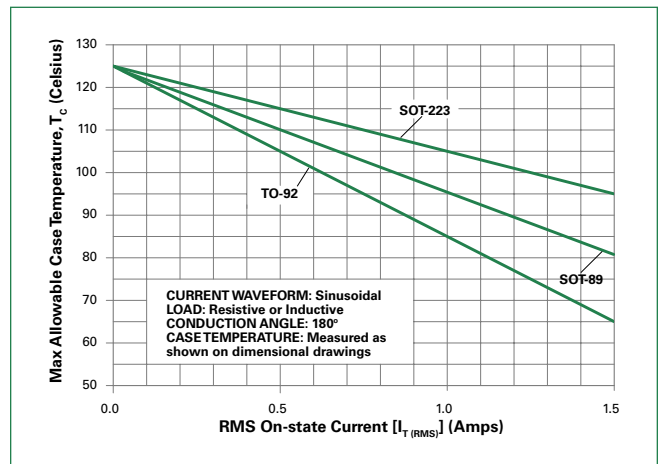

# Sx02xSx EV Series

## EV Series 1.5 Amp Sensitive SCRs

Figure 7: Typical DC Gate Trigger Current with  $R_{GK}$  vs. Junction Temperature for Sx02xS

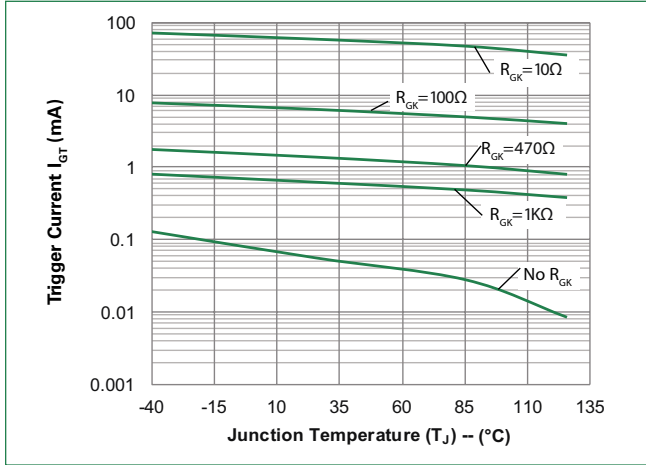

Figure 8: Typical DC Holding Current with  $R_{GK}$  vs. Junction Temperature for Sx02xS

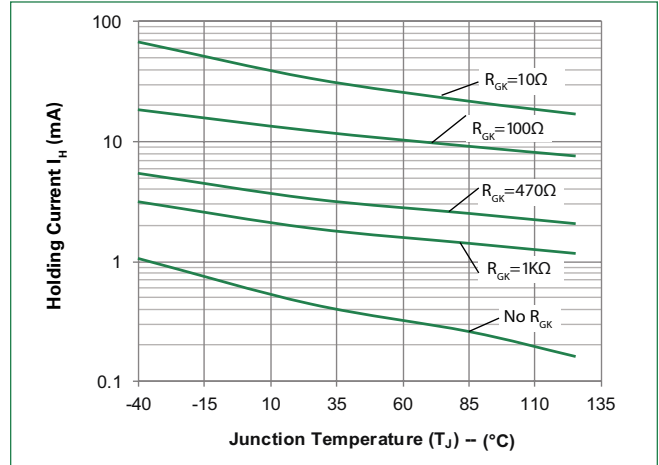

Figure 9: Typical Static dv/dt with  $R_{GK}$  vs. Junction Temperature for Sx02xS

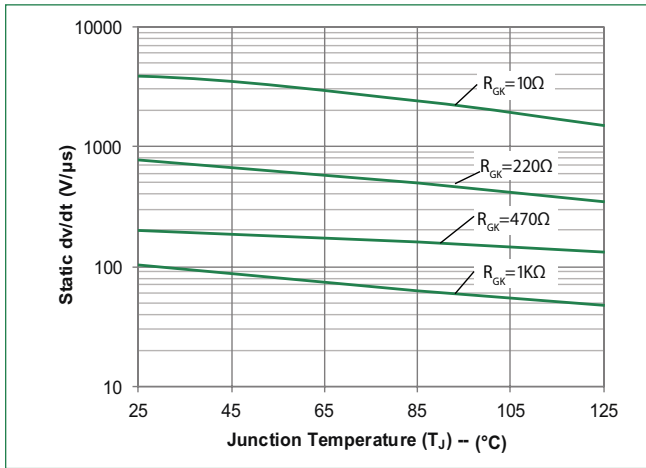

Figure 10: Typical turn off time with  $R_{GK}$  vs. Junction Temperature for Sx02xS

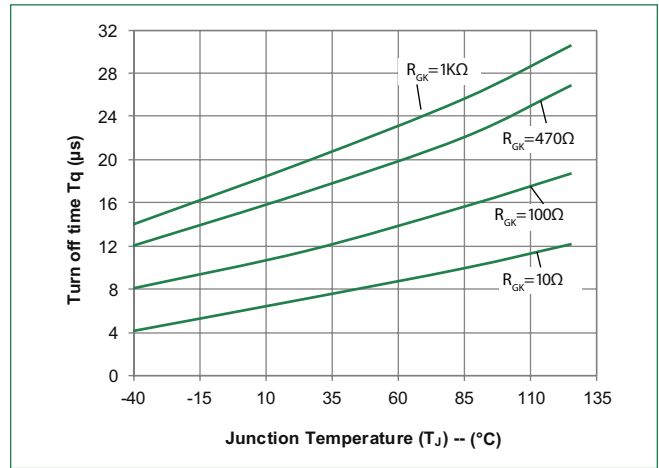
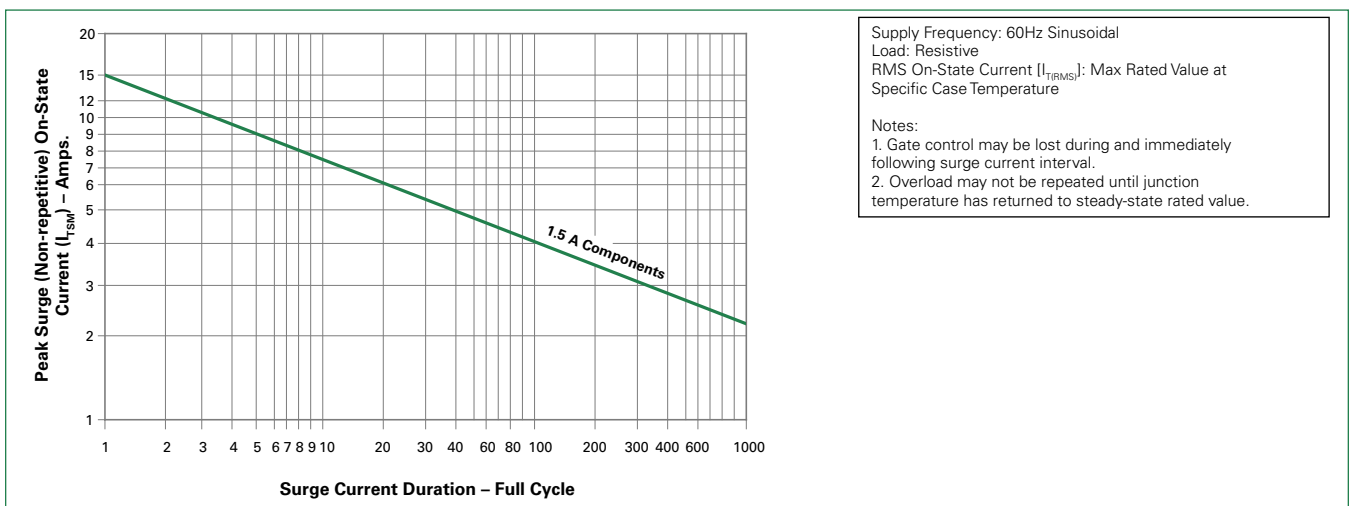

Figure 11: Surge Peak On-State Current vs. Number of Cycles



# Sx02xSx EV Series

## EV Series 1.5 Amp Sensitive SCRs

### Soldering Parameters

<b>Reflow Condition</b>		Pb – Free assembly
<b>Pre Heat</b>	- Temperature Min ( $T_{s(min)}$ )	150°C
	- Temperature Max ( $T_{s(max)}$ )	200°C
	- Time (min to max) ( $t_s$ )	60 – 180 secs
<b>Average ramp up rate (Liquidus Temp) (<math>T_L</math>) to peak</b>		5°C/second max
<b><math>T_{s(max)}</math> to <math>T_L</math> - Ramp-up Rate</b>		5°C/second max
<b>Reflow</b>	- Temperature ( $T_L$ ) (Liquidus)	217°C
	- Time (min to max) ( $t_s$ )	60 – 150 seconds
<b>Peak Temperature (<math>T_p</math>)</b>		260 <sup>+0/-5</sup> °C
<b>Time within 5°C of actual peak Temperature (<math>t_p</math>)</b>		20 – 40 seconds
<b>Ramp-down Rate</b>		5°C/second max
<b>Time 25°C to peak Temperature (<math>T_p</math>)</b>		8 minutes Max.
<b>Do not exceed</b>		280°C

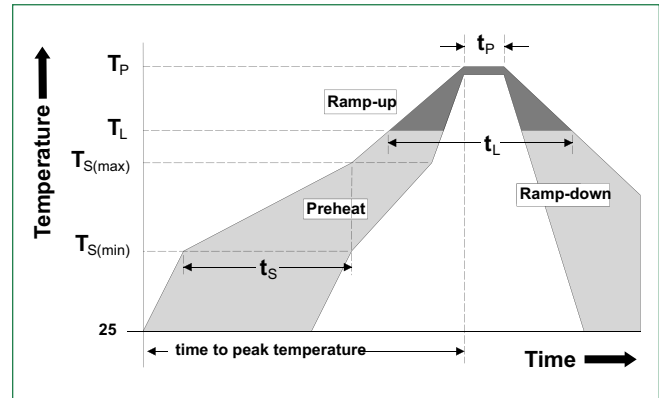

### Physical Specifications

<b>Terminal Finish</b>	100% Matte Tin-plated.
<b>Body Material</b>	UL Recognized compound meeting flammability rating V-0
<b>Lead Material</b>	Copper Alloy

### Design Considerations

Careful selection of the correct component for the application's operating parameters and environment will go a long way toward extending the operating life of the Thyristor. Good design practice should limit the maximum continuous current through the main terminals to 75% of the component rating. Other ways to ensure long life for a power discrete semiconductor are proper heat sinking and selection of voltage ratings for worst case conditions. Overheating, overvoltage (including  $dv/dt$ ), and surge currents are the main killers of semiconductors. Correct mounting, soldering, and forming of the leads also help protect against component damage.

### Environmental Specifications

Test	Specifications and Conditions
<b>AC Blocking</b>	MIL-STD-750, M-1040, Cond A Applied Peak AC voltage @ 125°C for 1008 hours
<b>Temperature Cycling</b>	MIL-STD-750, M-1051, 100 cycles; -40°C to +150°C; 15-min dwell-time
<b>Temperature/Humidity</b>	EIA / JEDEC, JESD22-A101 1008 hours; 160V - DC; 85°C; 85% rel humidity
<b>Resistance to Solder Heat</b>	MIL-STD-750 Method 2031
<b>Solderability</b>	ANSI/J-STD-002, category 3, Test A
<b>Lead Bend</b>	MIL-STD-750, M-2036 Cond E

# Sx02xSx EV Series

## EV Series 1.5 Amp Sensitive SCRs

### Dimensions – TO-92 (E Package)

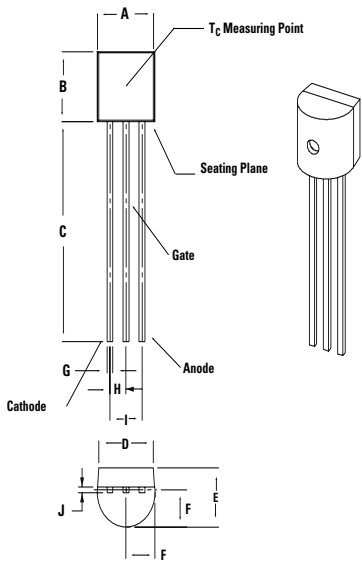

Dimensions	Inches		Millimeters	
	Min	Max	Min	Max
A	0.175	0.205	4.450	5.200
B	0.170	0.210	4.320	5.330
C	0.500	—	12.700	—
D	0.135	—	3.430	—
E	0.125	0.165	3.180	4.190
F	0.080	0.105	2.040	2.660
G	0.016	0.021	0.407	0.533
H	0.045	0.055	1.150	1.390
I	0.095	0.105	2.420	2.660
J	0.015	0.020	0.380	0.500

### Dimensions – SOT-223

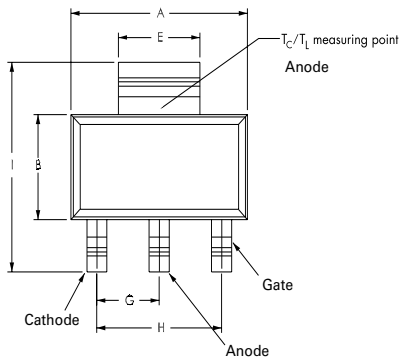

Pad Layout for SOT-223

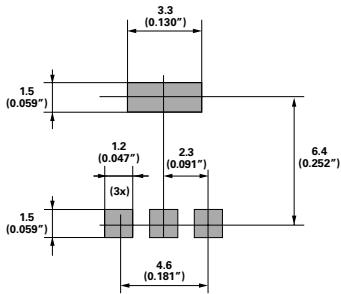

Dimensions in Millimeters (Inches)

Dimensions	Inches			Millimeters		
	Min	Typ	Max	Min	Typ	Max
A	0.248	0.256	0.264	6.30	6.50	6.70
B	0.130	0.138	0.146	3.30	3.50	3.70
C	—	—	0.071	—	—	1.80
D	0.001	—	0.004	0.02	—	0.10
E	0.114	0.118	0.124	2.90	3.00	3.15
F	0.024	0.027	0.034	0.60	0.70	0.85
G	—	0.090	—	—	2.30	—
H	—	0.181	—	—	4.60	—
I	0.264	0.276	0.287	6.70	7.00	7.30
J	0.009	0.010	0.014	0.24	0.26	0.35
K	10° MAX					

# Sx02xSx EV Series

## EV Series 1.5 Amp Sensitive SCRs

### Dimensions – SOT-89

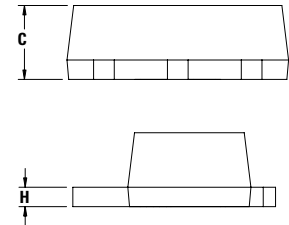
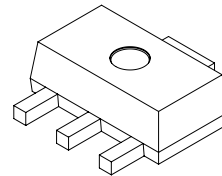
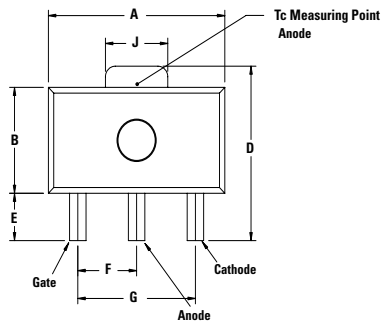

Pad Layout for SOT-89

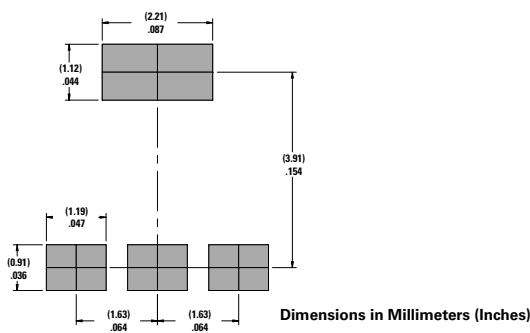

Dimension	Inches			Millimeters		
	Min	Typ	Max	Min	Typ	Max
A	0.173	—	0.181	4.40	—	4.60
B	0.090	—	0.102	2.29	—	2.60
C	0.055	—	0.063	1.40	—	1.60
D	0.155	—	0.167	3.94	—	4.25
E	0.035	—	0.047	0.89	—	1.20
F	0.056	—	0.062	1.42	—	1.57
G	0.115	—	0.121	2.92	—	3.07
H	0.014	—	0.017	0.35	—	0.44
I	0.014	—	0.019	0.36	—	0.48
J	0.064	—	0.072	1.62	—	1.83

### Product Selector

Part Numbr	Voltage		Gate Sensitivity	Package
	400V	600V		
Sx02BS	X	X	200 $\mu$ A	SOT-89
Sx02ES	X	X	200 $\mu$ A	TO-92
Sx02TS	X	X	200 $\mu$ A	SOT-223
Sx02BS1	X	X	100 $\mu$ A	SOT-89
Sx02ES1	X	X	100 $\mu$ A	TO-92
Sx02TS1	X	X	100 $\mu$ A	SOT-223
Sx02BS2	—	X	50 $\mu$ A	SOT-89

Note: x = voltage/100

### Packing Options

Part Number	Marking	Weight	Packing Mode	Base Quantity
Sx02ESy	Sx02ESy	0.217 g	Bulk	2500
Sx02ESyAP	Sx02ESy	0.217 g	Ammo Pack	2000
Sx02ESyRP	Sx02ESy	0.217 g	Tape & Reel	2000
Sx02TSyRP	Sx02TSy	0.120 g	Tape & Reel	1000
Sx02BSyRP	x02y	0.053 g	Tape & Reel	1000
Sx02BSyRP1	x02y	0.053 g	Tape & Reel	1000

# Sx02xSx EV Series

## EV Series 1.5 Amp Sensitive SCRs

### TO-92 (3-lead) Reel Pack (RP) Radial Leaded Specifications

Meets all EIA-468-C Standards

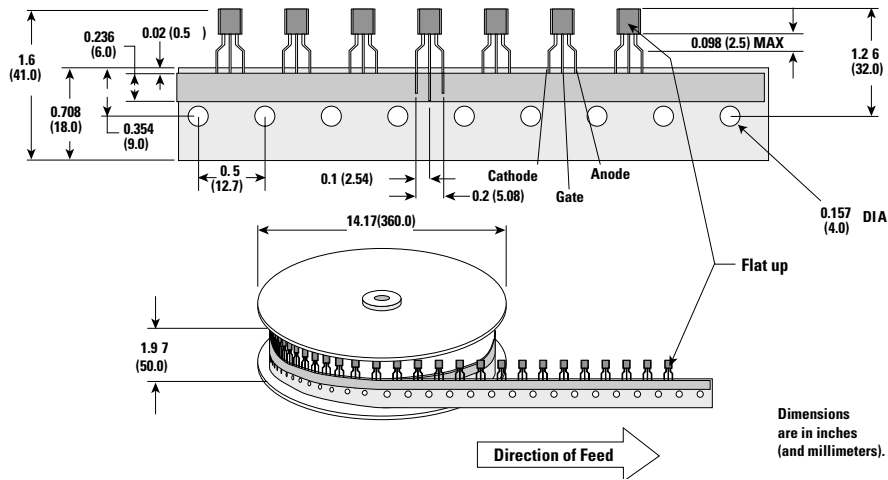

### SOT-89 Reel Pack (RP) Specifications

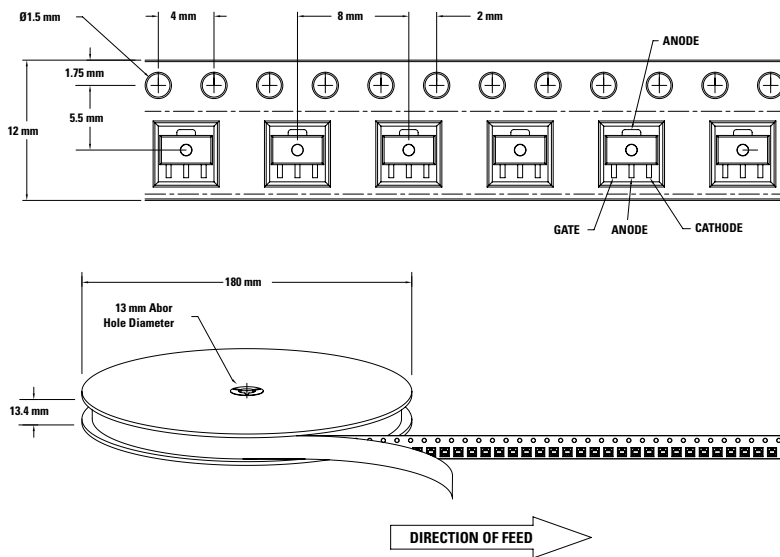

# Sx02xSx EV Series

## EV Series 1.5 Amp Sensitive SCRs

### SOT-89 Reel Pack (RP1) Specifications

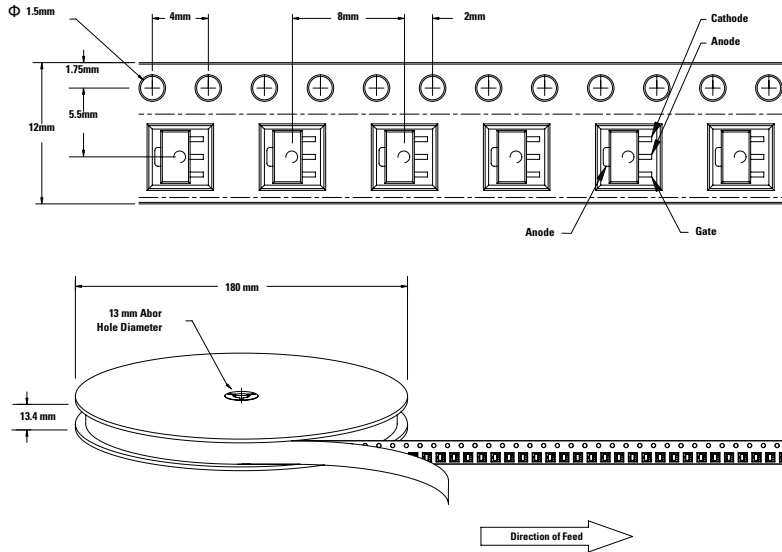

### TO-92 (3-lead) Ammo Pack (AP) Radial Leaded Specifications

Meets all EIA-468-C Standards

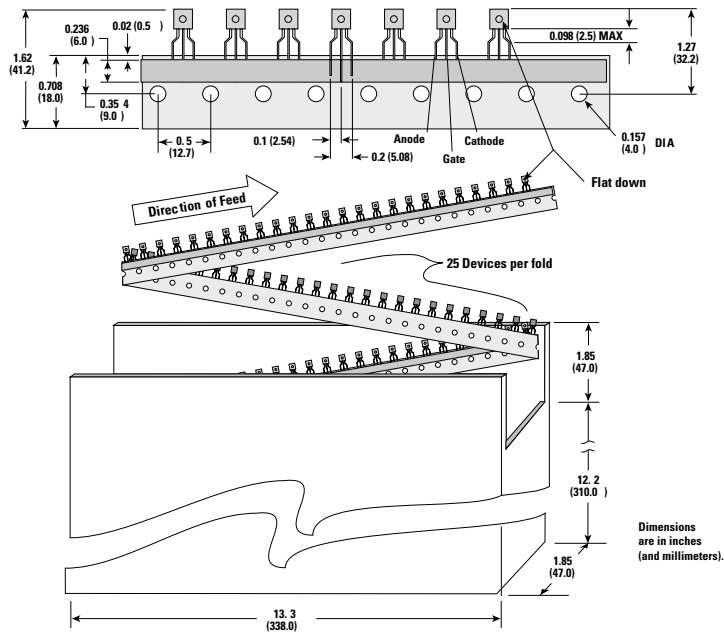

# Sx02xSx EV Series

## EV Series 1.5 Amp Sensitive SCRs

### SOT-223 Reel Pack (RP) Specifications

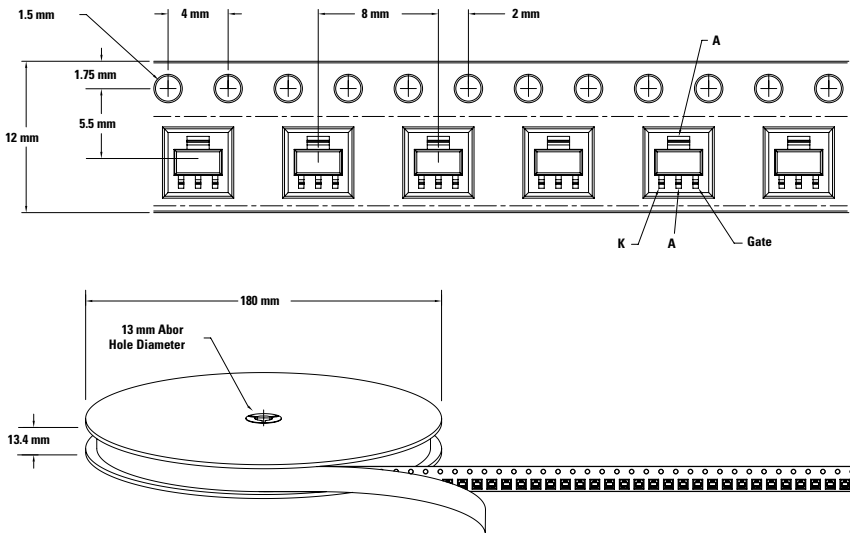

### Part Numbering System

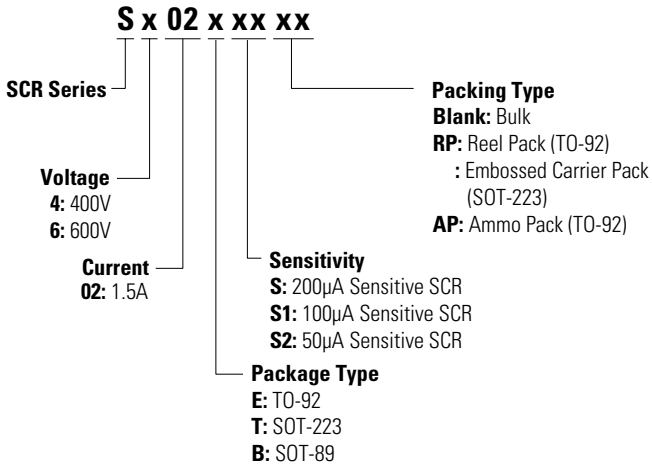

### Part Marking System

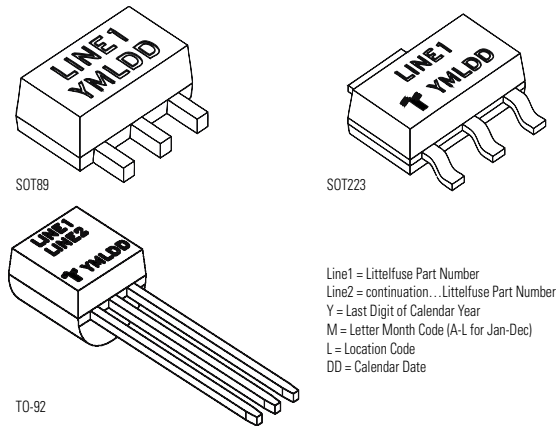

**Disclaimer Notice** - Information furnished is believed to be accurate and reliable. However, users should independently evaluate the suitability of and test each product selected for their own applications. Littelfuse products are not designed for, and may not be used in, all applications. Read complete Disclaimer Notice at [www.littelfuse.com/disclaimer-electronics](http://www.littelfuse.com/disclaimer-electronics).

## Looking for pricing, stock, or lifecycle information?

Click below to explore more details on WIN SOURCE:

 [View S402TSRP on WIN SOURCE](#)

 [Littelfuse Inc. Information](#)

## Optimize Your Supply Chain with WIN SOURCE Solutions

-  Global Sourcing Solution
-  Obsolete Management
-  Cost Control Management
-  Shortage Management
-  Alternative Solution
-  Excess Inventory Management