



**THE DATASHEET OF
S1751-46R**



PCB Hardware

Contents

SMT Test Points	300
SMT Cable Clips	301
Coin Cell Holders	302
SMT Jumper Links	304
PCB Jumper Links	305
PCB Terminals, Turret Lugs	306
Spacers / Pillars / Standoff	
Clearance Spacers	309
Threaded Spacers	310



SMT Hardware

Test Points

- ❖ Ideal for use with standard probes, clips and hooks.
- ❖ Can be placed using industry standard equipment.
- ❖ Suitable for automatic or manual test.
- ❖ High speed placement.
- ❖ Industry standard tape and reel packaging.
- ❖ Strong and durable.



<p>❖ Materials</p> <p>Material: Copper Alloy Finish: Tin</p> <p>❖ Packaging</p> <p>Format: Tape & Reel</p> <p>Reel quantity S1751-46R: 2,500 on a Ø330mm reel S2751-46R: 2,500 on a Ø178mm reel S2761-46R: 3,000 on a Ø178mm reel</p>	<p>2.00mm HIGH</p> <p>Recommended PC Board Pattern</p> <p>ORDER CODE S1751-46R</p>
<p>1.40mm HIGH</p> <p>Recommended PC Board Pattern</p> <p>ORDER CODE S2751-46R</p>	<p>1.15mm HIGH</p> <p>Recommended PC Board Pattern</p> <p>ORDER CODE S2761-46R</p>

All dimensions in mm.

SMT Hardware

Cable Management & Grounding Clips

- ❖ Suitable for use with insulated cables with outer diameters $\varnothing 0.9$ to $\varnothing 3$ mm and grounding braided coax cables.
- ❖ Cable clip can be soldered at same time as rest of board, reducing additional operation time required for mounting plastic clip types.
- ❖ Low profile & small footprint saves PCB space.

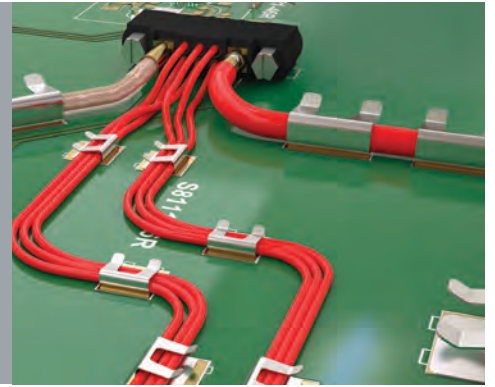

SMT HARDWARE

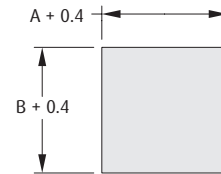
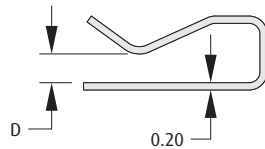
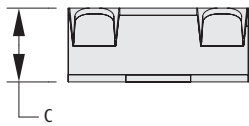
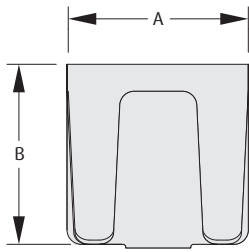

Recommended PCB Board Pattern

Materials

Material: Copper Alloy
Finish: Tin

Packaging

Format: Tape & Reel
Reel quantity: $\varnothing 330$ mm reel, see table

HOW TO ORDER

PART NO.	A	B	C	D	COAX GROUNDING	CABLE RETENTION	REEL QUANTITY
S8091-46R	5.00	4.00	1.35	0.70	$\varnothing 1.12$ mm	2 x $\varnothing 0.9$ mm	3,000
S8101-46R	5.00	4.00	1.50	0.80	RG178, RG179, RG316	2 x $\varnothing 1.0$ mm	3,000
S8111-46R	5.00	5.00	2.05	0.80	RG174, RG179, RG316	3 x $\varnothing 1.0$ mm, 2 x $\varnothing 1.5$ mm	1,500
S8121-46R	7.00	5.50	2.55	1.30	n/a	2 x $\varnothing 1.5$ mm, 1 x $\varnothing 2.0$ mm	1,300
S8131-46R	10.00	8.00	3.55	1.80	RG58	3 x $\varnothing 2.0$ mm, 1 x $\varnothing 3.0$ mm	800

All dimensions in mm.

SMT Coin Cell Holder

Battery Retainer for Ø12mm Coin Cell

- ❖ Tape & reel packaged for auto-placement to PCB.
- ❖ Highly effective retention of coin cell batteries.
- ❖ Eliminates the need for soldered-in coin cells.
- ❖ Low profile design available with dual independent contact points for enhanced electrical reliability.
- ❖ Accommodates CR1220, CR1225 and similar coin cell batteries.



LOW PROFILE

❖ Packaging

Format: Tape & Reel
 Reel quantity: 1,000 on a Ø330mm reel
 Suitable for battery size: BR1225, CR1216, CR1220, CR1225

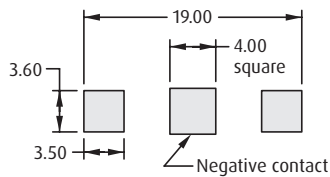
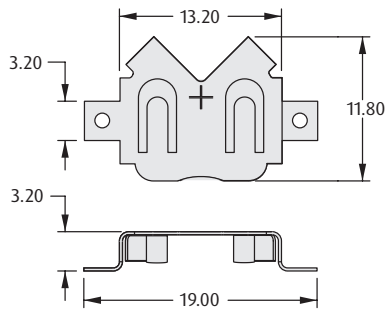

Recommended PC Board Pattern

STANDARD

❖ Packaging

Format: Tape & Reel
 Reel quantity: 500 on a Ø330mm reel
 Suitable for battery size: CR1220

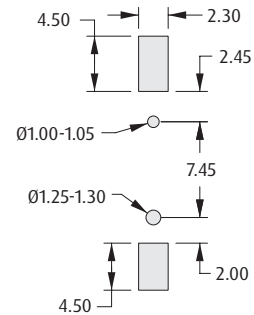
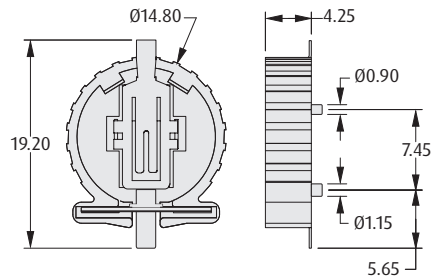

Recommended PC Board Pattern

HOW TO ORDER

S8 XX1 - XX R

SERIES CODE

TYPE	
201	Low Profile
411	Standard

PACKAGING	
R	Tape & Reeled

FINISH	
45	Gold (S8411)
46	Tin (S8201)

All dimensions in mm.

Coin Cell Holder

Battery Retainer for Ø20mm Coin Cell

- Horizontal designs are tape & reel packaged for auto placement.
- Highly effective retention of coin cell batteries.
- Eliminates the need for soldered-in cells.
- Vertical mount minimises PCB real estate usage.
- Low profile design available with dual independent contact points for enhanced electrical reliability.
- Accommodates CR2032 and similar coin cell batteries.

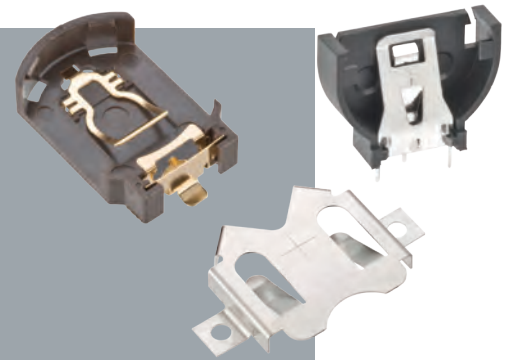

LOW PROFILE		STANDARD											
<p>⚡ Packaging</p> <p>Format: Tape & Reel Reel quantity: 550 on a Ø330mm reel Suitable for battery size: CR2016, CR2025, CR2032</p>		<p>⚡ Packaging</p> <p>Format: Tape & Reel Reel quantity: 500 on a Ø330mm reel Suitable for battery size: CR2032</p>											
<p>VERTICAL</p>													
<p>⚡ Packaging</p> <p>Format: Reeled Tray Suitable for battery size: CR2032</p>													
<p>HOW TO ORDER</p> <p style="font-size: 1.5em; font-weight: bold;">S8 XX1 - XX R</p>													
<p>SERIES CODE</p>		<p>PACKAGING</p> <table border="1"> <tr> <td>R</td> <td>Tape & Reeled</td> </tr> <tr> <td>Blank</td> <td>Reeled Tray (S8401)</td> </tr> </table>		R	Tape & Reeled	Blank	Reeled Tray (S8401)						
R	Tape & Reeled												
Blank	Reeled Tray (S8401)												
<p>TYPE</p> <table border="1"> <tr> <td>211</td> <td>Low Profile</td> </tr> <tr> <td>401</td> <td>Vertical</td> </tr> <tr> <td>421</td> <td>Standard</td> </tr> </table>		211	Low Profile	401	Vertical	421	Standard	<p>FINISH</p> <table border="1"> <tr> <td>45</td> <td>Gold (S8421)</td> </tr> <tr> <td>46</td> <td>Tin (S8201, S8401)</td> </tr> </table>		45	Gold (S8421)	46	Tin (S8201, S8401)
211	Low Profile												
401	Vertical												
421	Standard												
45	Gold (S8421)												
46	Tin (S8201, S8401)												

All dimensions in mm.

SMT Hardware

SMT Fixed Jumper Link

- Designed to link PCB tracks where through hole links are not possible.
- Typical applications include use on aluminium backplanes in power applications.
- High current.
- Small footprint.
- Low profile options available for space saving design.

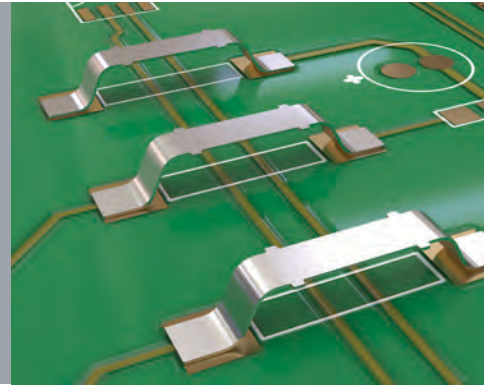

Materials

Material: Copper Alloy (S1621, S1911)
Copper (S1731)

Finish: Tin

Packaging

Format: Tape & Reel

Reel quantity

S1621-46R:	5,000 on a Ø330mm reel
S1731-46R:	2,500 on a Ø330mm reel
S1911-46R:	4,000 on a Ø330mm reel

12.3mm LONG

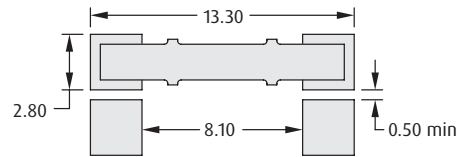
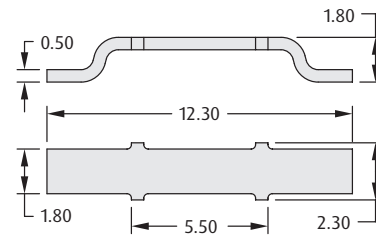

Recommended PC Board Pattern

ORDER CODE
S1621-46R

6.86mm LONG, 2.54mm HIGH

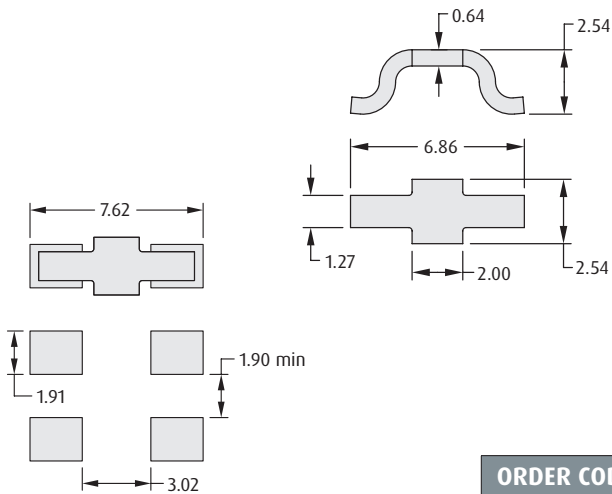

Recommended PC Board Pattern

ORDER CODE
S1731-46R

6.85mm LONG, 0.97mm HIGH

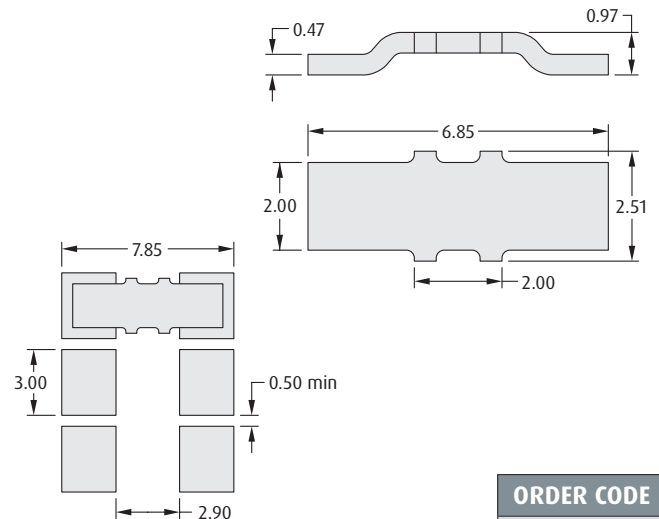

Recommended PC Board Pattern

ORDER CODE
S1911-46R

All dimensions in mm.

PCB Hardware

Ø1mm Shorting Link Plugs

- Choice of insulated or un-insulated links.
- Insulated links supplied in a variety of colors, with a high-performance gold finish.
- Un-insulated links can be soldered directly into the PCB for permanent linking.
- Can be used with individual PCB sockets for hardware programming applications.

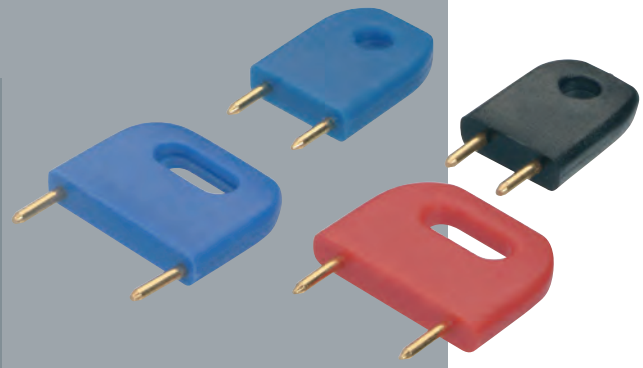

INSULATED

Style 1

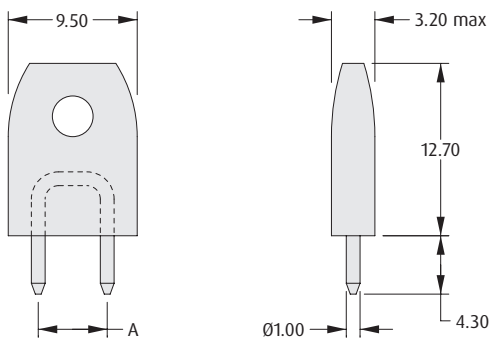

Style 2

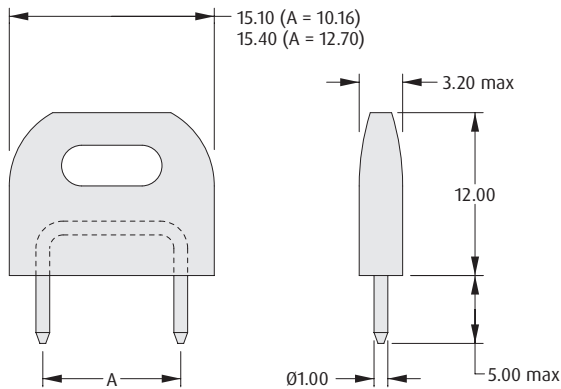

Materials

Housing: PBT UL94V-0
 Contact: Brass
 Finish
 Insulated: Gold
 Un-insulated: See order code

Electrical

Current rating: 10A at 20°C

UN-INSULATED

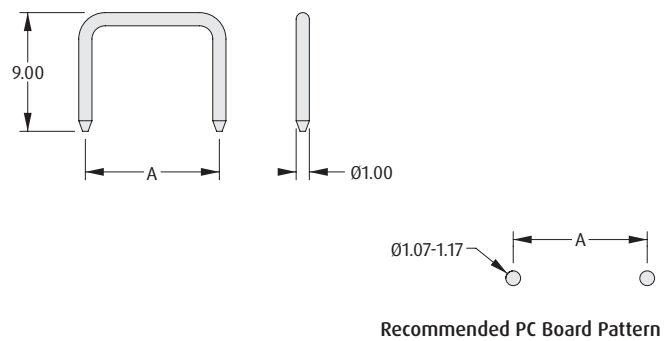

HOW TO ORDER

D308 X - XX

SERIES CODE

PITCH (A)	STYLE
6	5.08mm 1
7	6.35mm 1
8	10.16mm 2
9	12.70mm 2

COLOR

97	Blue
98	Black
99	Red

HOW TO ORDER

D308 X - XX

SERIES CODE

PITCH (A)	
0	5.08mm
1	6.35mm
2	10.16mm

FINISH

05	Gold
46	Tin

All dimensions in mm.

PCB Hardware

Turned Terminals

- Material: Brass with tin plating - also available in gold plating for the Ø1mm and Ø1.75mm chamfered terminal pins (H217x and H218x series).
- Retention by swaging feature available.
- Suitable for a variety of PCB thicknesses from 1.6mm to 3.2mm.

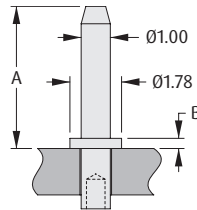

ORDER CODE (TIN)	H2174-01	H2175-01	H2173-01	H2176-01	H2170-01	H2171-01
ORDER CODE (GOLD)	H2174-05	H2175-05	H2173-05	H2176-05	H2170-05	H2171-05
A	4.32mm	4.90mm	8.13mm	9.53mm	13.21mm	19.56mm
B	0.51mm	0.35mm	0.51mm	0.51mm	0.51mm	0.51mm
PANEL THICKNESS	1.60mm	1.60mm	1.60mm	1.60mm	1.60mm	1.60mm
MOUNTING HOLE	Ø1.04 - 1.14mm	Ø1.04 - 1.14mm	Ø1.04 - 1.14mm	Ø1.04 - 1.14mm	Ø1.04 - 1.14mm	Ø1.04 - 1.14mm

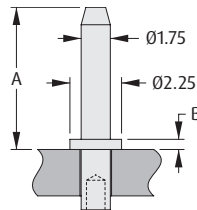

ORDER CODE (TIN)	H2181-01	H2182-01	H2183-01	H2184-01	H2185-01
ORDER CODE (GOLD)	H2181-05	H2182-05	H2183-05	H2184-05	H2185-05
A	5.35mm	8.45mm	9.85mm	15.65mm	22.00mm
B	0.35mm	0.35mm	0.35mm	0.35mm	0.35mm
PANEL THICKNESS	1.60mm	1.60mm	1.60mm	1.60mm	1.60mm
MOUNTING HOLE	Ø1.80 - 1.90mm	Ø1.80 - 1.90mm	Ø1.80 - 1.90mm	Ø1.80 - 1.90mm	Ø1.80 - 1.90mm

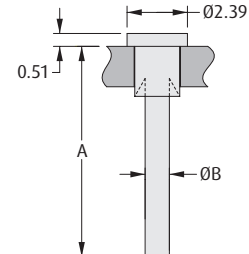
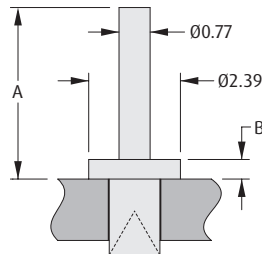
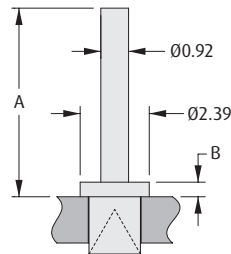

ORDER CODE	H2101A01	H2103A01	H2105A01	H2106A01	H2101B01	H2105B01
A	6.53mm	6.53mm	4.47mm	4.47mm	8.39mm	6.37mm
B	0.51mm	0.51mm	0.51mm	0.51mm	Ø0.93mm	Ø0.77mm
PANEL THICKNESS	1.60mm	3.20mm	1.60mm	2.40mm	1.60mm	1.60mm
MOUNTING HOLE	Ø1.79 - 1.87mm	Ø1.79 - 1.87mm	Ø1.33 - 1.41mm	Ø1.33 - 1.41mm	Ø1.79 - 1.87mm	Ø1.33 - 1.41mm

All dimensions in mm.

PCB Hardware

Turned Terminals

- Material: Brass with tin plating.
- Retention by swaging feature available.
- Suitable for a variety of PCB thicknesses from 1mm to 3.2mm.

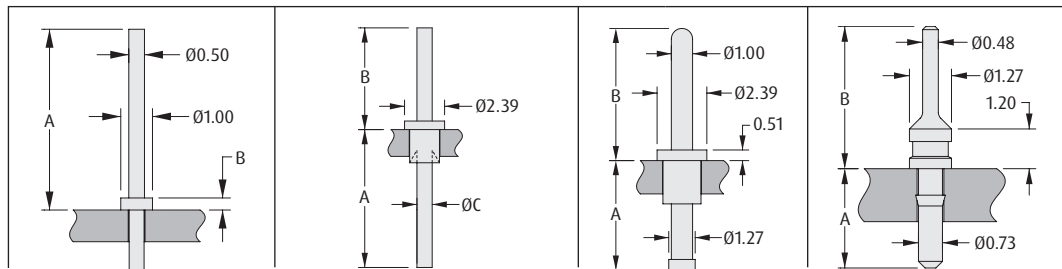

ORDER CODE	H3108-01	H2101-01	H2105-01	H9051-01	H2475-01
A	5.70mm	8.23mm	5.05mm	5.26mm	3.00mm
B	0.38mm	6.07mm	4.48mm	6.35mm	4.30mm
C	-	Ø0.87mm	Ø0.77mm	-	-
PANEL THICKNESS	1.00mm	1.60mm	1.60mm	1.60mm	1.60mm
MOUNTING HOLE	Ø0.50 - 0.55mm	Ø1.79 - 1.87mm	Ø1.33 - 1.41mm	Ø1.83 - 1.88mm	Ø0.77 - 0.85mm

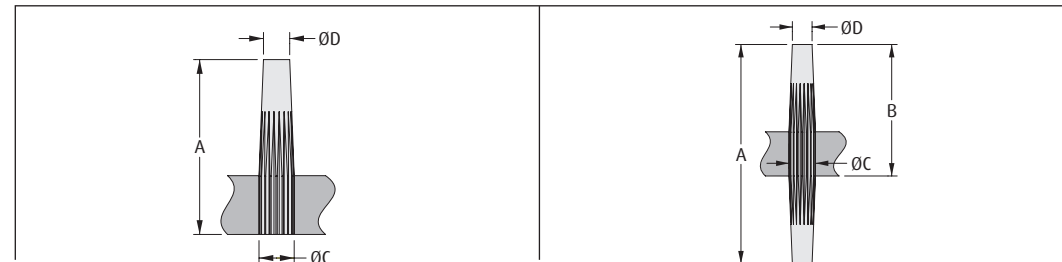

ORDER CODE	H2088-01	H2085-01	H2081-01	H2089-01	H2087-01	H2083-01
A	7.14mm	7.14mm	9.53mm	11.91mm	11.91mm	15.88mm
B	-	-	-	7.14mm	7.14mm	9.52mm
C	Ø1.13mm	Ø1.43mm	Ø1.68mm	Ø1.13mm	Ø1.43mm	Ø1.68mm
D	Ø0.76mm	Ø1.12mm	Ø1.22mm	Ø0.76mm	Ø1.12mm	Ø1.22mm
PANEL THICKNESS	2.40mm	2.40mm	2.40mm	2.40mm	2.40mm	2.40mm
MOUNTING HOLE	Ø1.00 - 1.05mm	Ø1.30 - 1.35mm	Ø1.55 - 1.60mm	Ø1.00 - 1.05mm	Ø1.30 - 1.35mm	Ø1.55 - 1.60mm

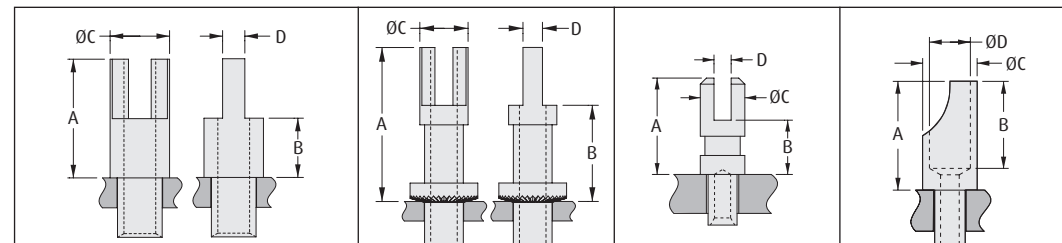

ORDER CODE	H2051-01	H2055-01	H2039-01	H9023-01	H9026-01
A	4.78mm	6.35mm	12.65mm	3.96mm	6.35mm
B	2.39mm	3.17mm	7.90mm	2.23mm	5.08mm
C	Ø3.18mm	Ø3.18mm	Ø3.90mm	Ø1.83mm	Ø3.18mm
D	0.73mm	1.13mm	1.54mm	0.71mm	Ø2.39mm
THROUGH HOLE	Ø1.06mm	Ø1.74mm	Ø2.22mm	-	Ø1.13mm
PANEL THICKNESS	1.60mm	2.40mm	3.20mm	1.60mm	2.40mm
MOUNTING HOLE	Ø1.60 - 1.68mm	Ø2.40 - 2.48mm	Ø3.19 - 3.27mm	Ø1.28 - 1.38mm	Ø1.84 - 1.92mm

All dimensions in mm.

PCB Hardware

Turned Terminals

- Material: Brass with tin plating.
- Retention by swaging feature available.
- Suitable for a variety of PCB thicknesses from 1.6mm to 3.2mm.

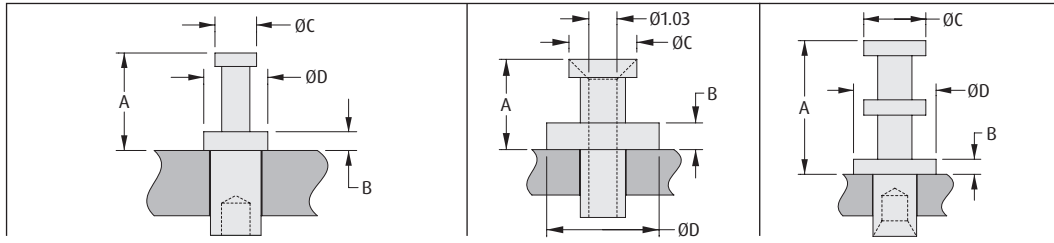

ORDER CODE	H9001-01	H9004-01	H2061-01	H2121-01
A	2.39mm	4.74mm	3.18mm	5.15mm
B	0.46mm	1.19mm	0.94mm	0.58mm
C	Ø1.02mm	Ø1.91mm	Ø2.33mm	Ø2.39mm
D	Ø1.57mm	Ø3.18mm	Ø4.03mm	Ø3.18mm
PANEL THICKNESS	1.60mm	1.60mm	1.60mm	1.60mm
MOUNTING HOLE	Ø1.25 - 1.33mm	Ø2.01 - 2.09mm	Ø1.60 - 1.68mm	Ø1.69 - 1.74mm

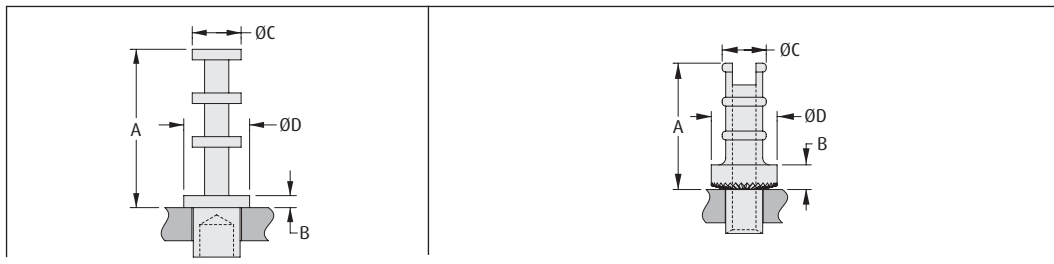

ORDER CODE	H9020-01	H9021-01	H2072-01	H2072Z01	H2072ZL1
A	7.65mm	7.65mm	6.29mm	6.52mm	6.52mm
B	0.58mm	0.58mm	1.01mm	1.24mm	1.24mm
C	Ø2.36mm	Ø2.36mm	Ø3.25mm	Ø2.54mm	Ø2.54mm
D	Ø3.18mm	Ø3.18mm	Ø3.96mm	Ø3.96mm	Ø3.96mm
PANEL THICKNESS	1.60mm	2.40mm	1.60mm	1.60mm	2.40mm
MOUNTING HOLE	Ø2.35 - 2.45mm	Ø2.35 - 2.45mm	Ø2.17 - 2.27mm	Ø2.01 - 2.11mm	Ø2.01 - 2.11mm

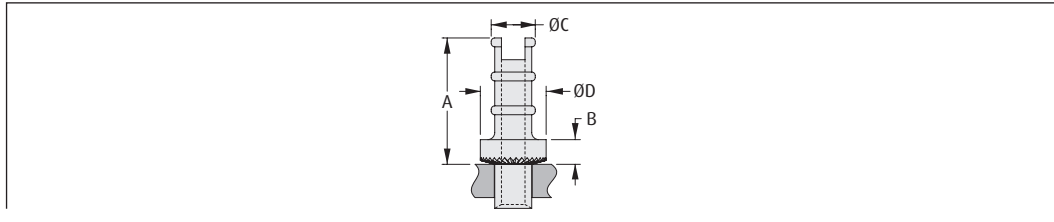

ORDER CODE	H2074Z01	H2071ZS1	H2071Z01	H2073Z01
A	8.74mm	9.12mm	9.12mm	9.12mm
B	1.60mm	1.78mm	1.78mm	1.78mm
C	Ø4.57mm	Ø3.18mm	Ø3.18mm	Ø3.18mm
D	Ø6.35mm	Ø4.75mm	Ø4.75mm	Ø4.75mm
PANEL THICKNESS	3.20mm	1.60mm	2.40mm	3.20mm
MOUNTING HOLE	Ø3.93 - 4.03mm	Ø2.68 - 2.78mm	Ø2.68 - 2.78mm	Ø2.68 - 2.78mm

All dimensions in mm.

Metric Spacers

Clearance Spacers

- Standard lengths available from 3 to 30mm.
- Brass spacers: base material is free-machining brass, with nickel plating.
- Aluminium spacers: supplied with a clear passivation finish to prevent oxidation.
- Plastic material: Nylon 66 UL94V-2.

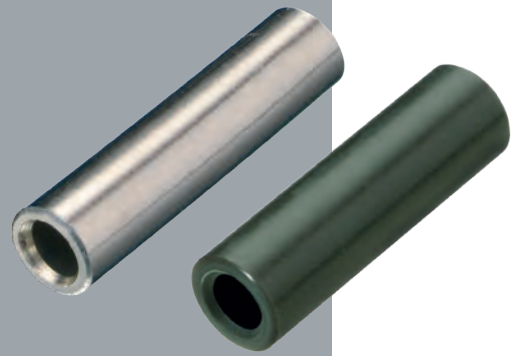

CLEARANCE FOR M3 THREAD

Materials

Base material: Brass, Aluminium or Plastic

Finish

Brass: Nickel
Aluminium: Clear Passivate

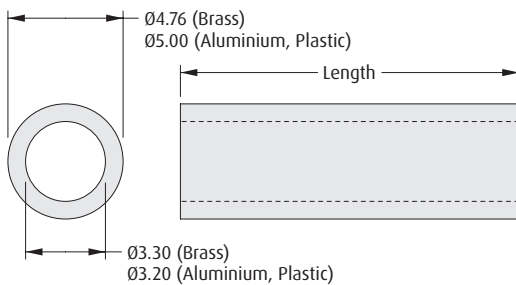

CLEARANCE FOR M4 THREAD

Materials

Base material: Brass or Plastic

Finish

Brass: Nickel

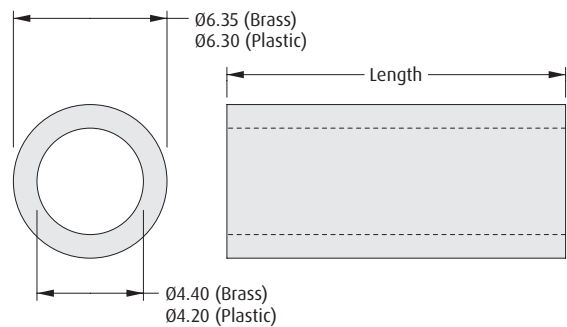

HOW TO ORDER

R30 - 6 XX XX XX

SERIES CODE

MATERIAL

01	Brass
20	Aluminium
70	Plastic

LENGTH (mm)

03 to 16, 18, 20, 25, 30	Brass, Aluminium
03 to 16, 18, 20, 25	Plastic

FINISH

02	Nickel (Brass only)
14	Passivation (Aluminium only)
94	White (Plastic only)

HOW TO ORDER

R40 - 6 XX XX XX

SERIES CODE

MATERIAL

00	Brass
71	Plastic

LENGTH (mm)

03 to 16, 18, 20, 25, 30	Brass
03, 05 to 08, 10 to 12, 15, 18	Plastic

FINISH

02	Nickel (Brass only)
94	White (Plastic only)

All dimensions in mm.

Metric Spacers

SPACERS

Threaded Female Spacers

- Available in a variety of standard body lengths.
- Brass spacers: base material is free-machining brass, with nickel plating.
- Plastic material: Nylon 66 UL94V-2.
- Longer thread lengths may not be threaded through the complete length, but have female threads at both ends.

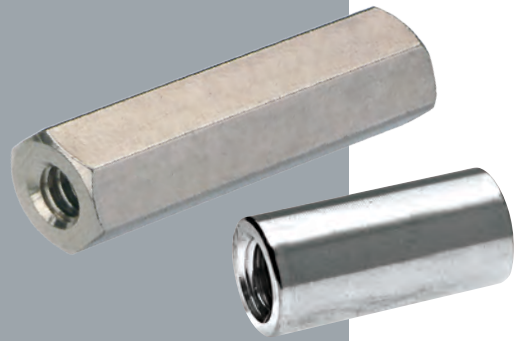

HEXAGONAL	CIRCULAR
<p>Materials</p> <p>Base material: Brass or Plastic</p> <p>Finish: Nickel</p> <p>Brass: Nickel</p>	<p>Materials</p> <p>Base material: Brass</p> <p>Finish: Nickel</p> <p>Brass: Nickel</p>
<p>5.00 A/F (R25-100, R30-100) 5.50 A/F (R30-101, R30-161) 7.00 A/F (R40-100)</p> <p>M2.5 (R25), M3 (R30) or M4 (R40)</p> <p>Length</p>	<p>Ø4.76</p> <p>M3</p> <p>Length</p>

HOW TO ORDER

RXX - XXX XX XX

SERIES CODE	
R25-100	Hexagonal, Brass, M2.5 Thread
R30-100	Hexagonal, Brass, M3 Thread
R30-101	Hexagonal, Brass, M3 Thread
R30-161	Hexagonal, Plastic, M3 Thread
R30-500	Circular, Brass, M3 Thread
R40-100	Hexagonal, Brass, M4 Thread

FINISH	
00	White (Plastic only)
02	Nickel (Brass only)

LENGTH (mm)	
06 to 16, 18, 20, 25	R30-161, R40-100
04 to 16, 18, 20, 25	Other

All dimensions in mm.

Metric Spacers

Threaded Male Pillars

- Available in a choice of thread sizes, with a variety of standard body lengths.
- Base material is free-machining Brass, with nickel plating.

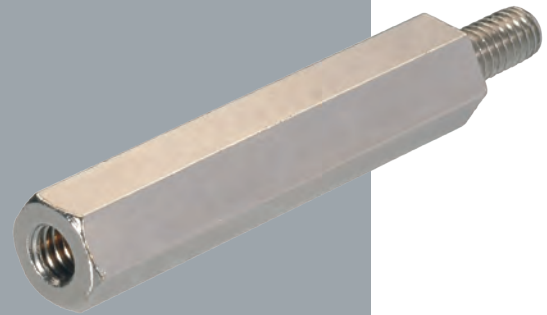

MALE/MALE		MALE/FEMALE																				
HOW TO ORDER																						
R30 - 400 XX 02																						
SERIES CODE R30 - 400		FINISH 02 Nickel																				
LENGTH (mm) 04 to 16, 18, 20, 25, 30, 35, 40																						
HOW TO ORDER																						
RXX - 30X XX 02																						
SERIES CODE R25-300 M2.5 Thread R30-300 M3 Thread, 6mm Stud R30-301 M3 Thread, 8mm Stud R40-300 M4 Thread		FINISH 02 Nickel																				
LENGTH (mm)																						
	03	04	05	06	07	08	09	10	11	12	13	14	15	16	18	20	25	30	35	40		
THREAD LENGTH		1.9	2.5	2.5	3.5	4.5	5.0	5.0	5.0	5.0	5.0	5.0	5.0	5.0	5.0	5.0	5.0	X	X	X	X	R25-300
		X	2.0	2.5	3.0	4.5	5.5	6.0	6.0	6.0	6.0	6.0	6.0	6.0	6.0	6.0	6.0	6.0	6.0	6.0	6.0	R30-300
		X	2.5	3.0	4.0	5.0	5.0	5.0	5.0	8.0	8.0	8.0	8.0	8.0	8.0	8.0	8.0	X	X	X	X	R30-301
		X	X	X	2.5	3.5	4.5	5.5	6.5	8.0	8.0	8.0	8.0	8.0	8.0	8.0	8.0	8.0	8.0	8.0	X	R40-300

All dimensions in mm.



Looking for pricing, stock, or lifecycle information?

Click below to explore more details on WIN SOURCE:

 [View S1751-46R on WIN SOURCE](#)

 [Harwin Inc. Information](#)

Optimize Your Supply Chain with WIN SOURCE Solutions

-  Global Sourcing Solution
-  Obsolete Management
-  Cost Control Management
-  Shortage Management
-  Alternative Solution
-  Excess Inventory Management