



THE DATASHEET OF RU4S-D24



RU Series Universal Relays

Key features:

- Full featured universal miniature relays
- Designed with environment taken into consideration
- Two terminal styles: plug-in and PCB mount
- Non-polarized LED indicator
- No internal wires, lead-free construction
- Cadmium-free contacts
- Mechanical flag indicator
- Manual latching lever with color coding for AC or DC coil
- Snap-on yellow marking plate; optional marking plates are available in four other colors
- Maximum contact ratings: 10A (RU2), 6A (RU4), 3A (RU42)
- UL Recognized, CSA Certified, EN Compliant

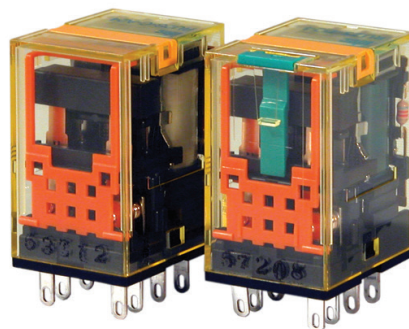

With Latching or Momentary Lever

Mechanical Indicator*

The contact position can be confirmed through the five small windows.

Marking Plate

Standard yellow marking plate is easily replaced with optional marking plates in four colors for easy identification of relays.

LED Indicator*

Non-polarized green LED indicator is standard provision for plug-in terminal, latching lever types

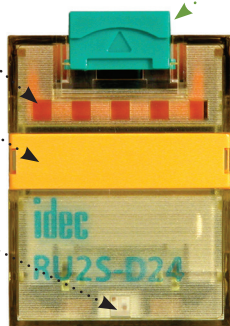

Latching and Momentary Lever

Using the lever, operation can be checked without energizing the coil. The lever is color coded for AC and DC coils.

| | Latching | Momentary |
|----------|----------|-----------|
| AC coil: | Orange | Red |
| DC coil: | Green | Blue |

In Normal Operation



Note: Turn off the power to the relay coil when using the latching lever. After checking the operation, return the latching lever in the normal position.

Standard (without lever)

AC/DC Color Marking

For identification of AC or DC coils.

- AC coil: Yellow
- DC coil: Blue

Mechanical Indicator*

Marking Plate

LED Indicator*

Non-polarized green LED indicator is standard provision for plug-in terminal types.



AC Coil

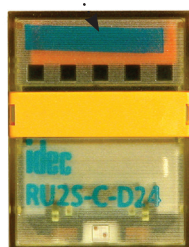

DC Coil

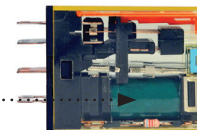

| Coil Voltage | Tape Color |
|----------------|--------------------------------|
| 24V AC | White |
| 100 to 110V AC | Clear |
| 110 to 120V AC | Blue |
| 200 to 220V AC | Black |
| 220 to 240V AC | Red |
| 24V DC | Green |
| 6V DC | |
| 12V DC | Voltage marking on yellow tape |
| 48V DC | |
| 110V DC | |



*Not available on PCB type.

Switches & Pilot Lights

Signaling Lights

Relays & Sockets

Timers

Contactors

Terminal Blocks

Circuit Breakers

Part Number Selection

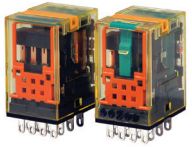
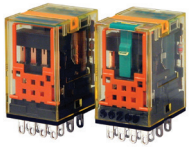
| Contact | Model | Part Number | | | Coil Voltage Code (Standard Stock in bold) |
|-----------------------------------------------------------------------------------------------------------|---------------------------|-------------|---------------------|----------------------|-------------------------------------------------------------------|
| | | Standard | With Latching Lever | With Momentary Lever | |
| DPDT (10A)  | Standard | RU2S-C-□ | RU2S-□ | RU2S-M-□ | A24, A110 , A220 D6, D12, D24 , D48, D110 |
| | With RC (AC coil only) | RU2S-CR-□ | RU2S-R-□ | RU2S-MR-□ | A110, A220 |
| | With diode (DC coil only) | RU2S-CD-□ | RU2S-D-□ | RU2S-MD-□ | D6, D12, D24 , D48, D110 |
| | PCB | RU2V-NF-□ | — | — | A24, A110, A220 D6, D12, D24 , D48, D110 |
| 4PDT (6A)  | Standard | RU4S-C-□ | RU4S-□ | RU4S-M-□ | A24, A110 , A220 D6, D12, D24 , D48, D110 |
| | With RC (AC coil only) | RU4S-CR-□ | RU4S-R-□ | RU4S-MR-□ | A110, A220 |
| | With diode (DC coil only) | RU4S-CD-□ | RU4S-D-□ | RU4S-MD-□ | D6, D12, D24, D48, D110 |
| | PCB | RU4V-NF-□ | — | — | A24, A110 , A220 D6, D12, D24 , D48, D110 |
| 4PDT Bifurcated (3A)  | Standard | RU42S-C-□ | RU42S-□ | RU42S-M-□ | A24, A110, A220 D6, D12, D24 , D48, D110 |
| | With RC (AC coil only) | RU42S-CR-□ | RU42S-R-□ | RU42S-MR-□ | A110, A220 |
| | With diode (DC coil only) | RU42S-CD-□ | RU42S-D-□ | RU42S-MD-□ | D6, D12, D24, D48, D110 |
| | PCB | RU42V-NF-□ | — | — | A24, A110, A220 D6, D12, D24 , D48, D110 |

- 1. Plug-in terminal models have an LED indicator and a mechanical indicator as standard.
- 2. PCB models do not have an LED indicator or a mechanical indicator.

Ordering Information





When ordering, specify the Part No. and coil voltage code:

(example) **RU2S-C** **A110**
Part No. Coil Voltage Code

Coil Voltage Table

| Coil Voltage Code | A24 | A110 | A220 | D6 | D12 | D24 | D48 | D110 |
|-------------------|--------|-------------|-------------|-------|--------|--------|--------|---------|
| Coil Rating | 24V AC | 110-120V AC | 220-240V AC | 6V DC | 12V DC | 24V DC | 48V DC | 110V DC |

Sockets

| Relays | Spring Clamp DIN Rail Mount | Standard DIN Rail Mount | Finger-safe DIN Rail Mount | Panel Mount | PCB Mount |
|-----------------------------|-------------------------------------------------------------------------------------|-------------------------------------------------------------------------------------|-------------------------------------------------------------------------------------|-------------------------------------------------------------------------------------|--------------------------------------------------------------------------------------|
| RU2S (DPDT) | SU2S-11L | SM2S-05 | SM2S-05C | SY4S-51 | SM2S-61 SM2S-62 |
| RU4S (4PDT) RU42S (4PDT) | SU4S-11L | SY4S-05 | SY4S-05C | | SY4S-61 SY4S-62 |
| |  |  |  |  |  |

Switches & Pilot Lights

Signaling Lights

Relays & Sockets

Timers



Contactors

Terminal Blocks

Circuit Breakers

Switches & Pilot Lights

Hold Down Springs & Clips

| Appearance | Item | Relay | For DIN Mount Socket | For Through Panel & PCB Mount Socket |
|-----------------------------------------------------------------------------------|--------------------------|---------------------|----------------------|--------------------------------------|
|  | Pullover Wire Spring | RU2S/RU4S/ RU42S | SY4S-02F1 | SY4S-51F1 |
|  | Leaf Spring (side latch) | RU2S/RU4S/ RU42S | SFA-202* | SFA-302* |
|  | Leaf Spring (top latch) | RU2S/RU4S/ RU42S | SFA-101* | SFA-301* |



Note: Order 2 pieces for each relay

Signaling Lights

Relays & Sockets

Accessories

| Name | Part Number | Color Code * |
|---------------|-------------|--------------------------------------------------------|
| Marking Plate | RU9Z-P* | A (orange), G (green), S (blue), W (white), Y (yellow) |



Specify a color code when ordering. The marking plate can be removed from the relay by inserting a flat screwdriver under the marking plate.

Specifications



| Model (Contact) | RU2 (DPDT) | RU4 (4PDT) | RU42 (4PDT-bifurcated) |
|--------------------------------------|---------------------------------------------------------------------------------------------------|-----------------------|---------------------------|
| Contact Material | Silver alloy | Silver (gold clad) | Silver-nickel (gold clad) |
| Contact Resistance ¹ | 50 mΩ maximum | | |
| Minimum Applicable Load ² | 24V DC, 5 mA (reference value) | 1V DC, 1 mA | 1V DC, 0.1 mA |
| Operating Time ³ | 20 ms maximum | | |
| Release Time ³ | 20 ms maximum | | |
| Power Consumption | AC: 1.1 to 1.4VA (50 Hz), 0.9 to 1.2VA (60 Hz) DC: 0.9 to 1.0W | | |
| Insulation Resistance | 100MΩ minimum (500V DC megger) | | |
| Dielectric Strength | Between contact and coil: 2500V AC, 1 minute | | |
| | Between contacts of different poles: | | |
| | 2500V AC, 1 minute | 2000V AC, 1 minute | |
| Operating Frequency | Between contacts of the same pole: 1000V AC, 1 minute | | |
| | Electrical: 1800 operations/h maximum Mechanical: 18,000 operations/h maximum | | |
| Vibration Resistance | Damage limits: 10 to 55 Hz, amplitude 0.5 mm Operating extremes: 10 to 55 Hz, amplitude 0.5 mm | | |
| Shock Resistance | Damage limits: 1000 m/s ² (100G) Operating extremes: 150 m/s ² (15G) | | |
| Mechanical Life | AC: 50,000,000 operations DC: 100,000,000 operations | 50,000,000 operations | |
| Electrical Life ⁴ | See table on page 894 | | |
| Operating Temperature ⁵ | PCB model: -55 to +70°C (no freezing) Blade model: -55 to +60°C (no freezing) | | |
| Operating Humidity | 5 to 85% RH (no condensation) | | |
| Weight | Approx. 35g | | |



1. Measured using 5V DC, 1A voltage drop method
2. Measured at operating frequency of 120 operations/min (failure rate level P, reference value)
3. Measured at the rated voltage (at 20°C), excluding contact bouncing;
Release time of AC relays with RC: 25 ms maximum
Release time of DC relays with diode: 40 ms maximum
4. Contact Load and Electrical Life (at ambient temperature 20°C)
5. Measured at the rated voltage.

Circuit Breakers

Accessories

| Item | Appearance | Use with | Part No. | Remarks |
|-------------------------------------|-----------------------------------------------------------------------------------|-------------------------------------|----------|-------------------------------------------------------------------------------------------------------------------------------------------------------------------------------------------------------------------------|
| Aluminum DIN Rail (1 meter length) |  | All DIN rail sockets | BNDN1000 | The BNDN1000 is designed to accommodate DIN mount sockets. Made of durable extruded aluminum, the BNDN1000 measures 0.413 (10.5mm) in height and 1.37 (35mm) in width (DIN standard). Standard length is 39" (1,000mm). |
| DIN Rail End Stop |  | DIN rail | BNL5 | 9.1 mm wide. |
| Replacement Hold-Down Spring Anchor |  | Horseshoe clip for DIN rail sockets | Y778-011 | For use on DIN rail mount socket when using pullover wire hold down spring. 2 pieces included with each socket. |

Coil Ratings

| Rated Voltage (V) | Coil Voltage Code | Rated Current (mA) ±15% (at 20°C) | | Coil Resistance (Ω) ±10% (at 20°C) | Operating Characteristics (values at 20°C) | | |
|-------------------|-------------------|-----------------------------------|----------|------------------------------------|--------------------------------------------|----------------|-----------------|
| | | 50 Hz | 60 Hz | | Maximum Continuous Applied Voltage | Pickup Voltage | Dropout Voltage |
| AC (50/60 Hz) | 24 | A24 | 49.3 | 42.5 | 110% | 80% maximum | 30% minimum |
| | 110-120 | A110 | 8.4-10.0 | 7.1-8.2 | | | |
| | 220-240 | A220 | 4.2-5.0 | 3.6-4.2 | | | |
| DC | 6 | D6 | 155 | | 110% | 80% maximum | 10% minimum |
| | 12 | D12 | 80 | | | | |
| | 24 | D24 | 44.7 | | | | |
| | 48 | D48 | 18 | | | | |
| | 110 | D110 | 8.9 | | | | |



1. The rated current includes the current of the LED indicator.

Surge Suppressor Ratings

| Model | | Ratings |
|---------|------------|-----------------------------------------------------------|
| AC Coil | With RC | RC series circuit R: 20 kΩ, C: 0.033 μF |
| DC Coil | With Diode | Diode reverse voltage: 1000V Diode forward current: 1A |

UL and c-UL Ratings

| Voltage | Resistive | | | General Use | | | Horse Power Rating | | |
|---------|-----------|-----|------|-------------|-----|------|--------------------|--------|------|
| | RU2 | RU4 | RU42 | RU2 | RU4 | RU42 | RU2 | RU4 | RU42 |
| 250V AC | 10A | — | 3A | — | 6A | — | — | 1/10HP | — |
| 30V DC | 10A | 6A | 3A | — | — | — | — | — | — |

Contact Ratings

| Maximum Contact Capacity | | | | | | |
|--------------------------|--------------------|-------------------------|----------------|-------------|------------|-----------|
| Contact | Continuous Current | Allowable Contact Power | | Voltage (V) | Rated Load | |
| | | Resistive Load | Inductive Load | | Res. Load | Ind. Load |
| DPDT | 10A | 2500VA AC | 1250VA AC | 250 AC | 10A | 5A |
| | | 300W DC | 150W DC | 30 DC | 10A | 5A |
| 4PDT | 6A | 1500VA AC | 600VA AC | 250 AC | 6A | 0.8A |
| | | 180W DC | 90W DC | 30 DC | 6A | 1.5A |
| 4PDT bifurcated | 3A | 750VA AC | 200VA AC | 250 AC | 3A | 0.8A |
| | | 90W DC | 45W DC | 30 DC | 3A | 1.5A |



1. On 4PDT relays, the maximum allowable total current of neighboring two poles is 6A. At the rated load, make sure that the total current of neighboring two poles does not exceed 6A (3A + 3A = 6A).
2. Inductive load for the rated load — $\cos \theta = 0.3$, L/R = 7 ms

CSA Ratings

| Voltage | Resistive |
|---------|-----------|
| | RU42 |
| 250V AC | 3A |
| 30V DC | 3A |

TÜV Ratings

| Voltage | Resistive | | | Inductive | | |
|---------|-----------|-----|------|-----------|------|------|
| | RU2 | RU4 | RU42 | RU2 | RU4 | RU42 |
| 250V AC | 10A | 6A | 3A | 5A | 0.8A | 0.8A |
| 30V DC | 10A | 6A | 3A | 5A | 1.5A | 1.5A |

Socket Specifications

| | Sockets | Terminal | Electrical Rating | Wire Size | Torque |
|----------------------------|----------|----------------------------------------------|---------------------------------------|------------------------|---------------|
| DIN Rail Mount Sockets | SU2S-11L | Spring clamp terminals | 250V/10A | 24-16 AWG | — |
| | SU4S-11L | Spring clamp terminals | 250V/6A (using RU4), 10A (using RU2) | 24-16 AWG | — |
| | SM2S-05 | M3 screw with captive wire clamp | 300V, 10A | Maximum up to 2-#14AWG | 5.5 - 9in•lbs |
| | SM2S-05C | M3 screw with captive wire clamp, fingersafe | 300V, 10A | Maximum up to 2-#14AWG | 5.5 - 9in•lbs |
| | SY4S-05 | M3 screw with captive wire clamp | 300V, 7A (using RU4), 10A (using RU2) | Maximum up to 2-#14AWG | 5.5 - 9in•lbs |
| | SY4S-05C | M3 screw with captive wire clamp, fingersafe | 300V, 7A (using RU4), 10A (using RU2) | Maximum up to 2-#14AWG | 5.5 - 9in•lbs |
| Through Panel Mount Socket | SY4S-51 | Solder | 300V, 7A | — | — |
| PCB Mount Socket | SY4S-61 | PCB mount | 300V, 7A | — | — |
| | SY4S-62 | PCB mount | 250V, 7A | — | — |

Electrical Life Curves

RU2 (Resistive Load)

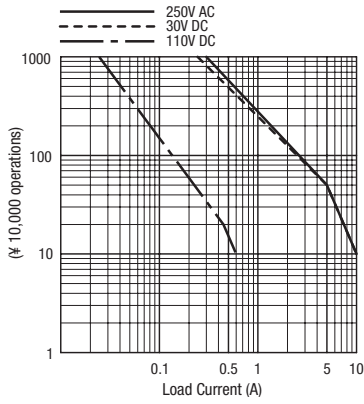

RU4 (Resistive Load)

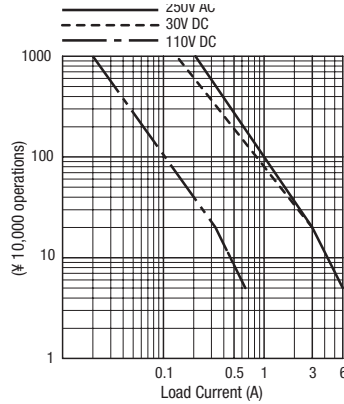

RU42 (Resistive Load)

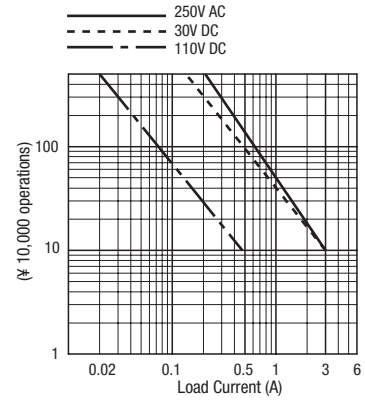

RU2 (Inductive Load)

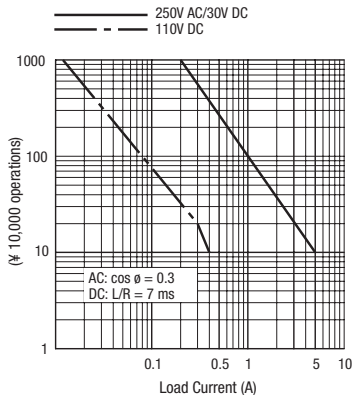

RU4 (Inductive Load)

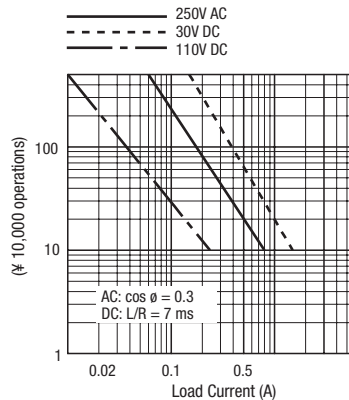

RU42 (Inductive Load)

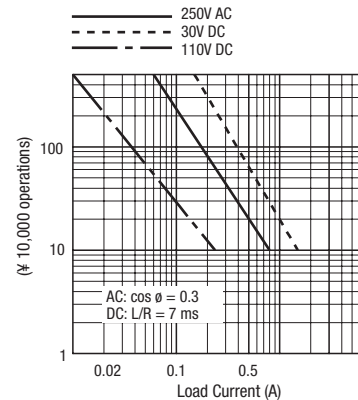

Maximum Switching Current

RU2

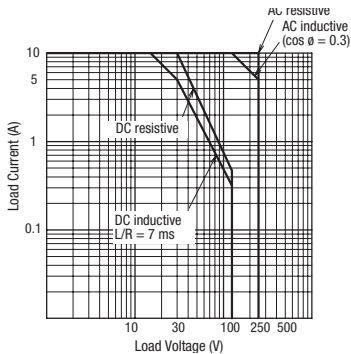

RU4

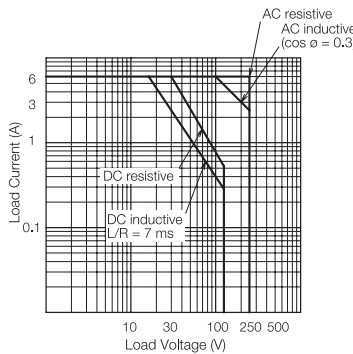

RU42 (Bifurcated)

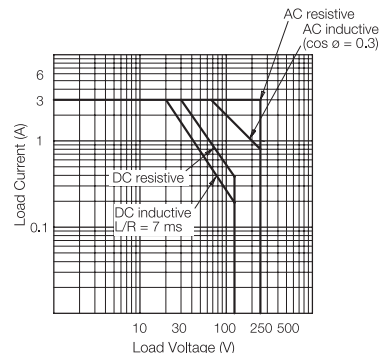

Ambient Temperature vs. Temperature Rise Curves

RU2 (AC Coil, 50 Hz)

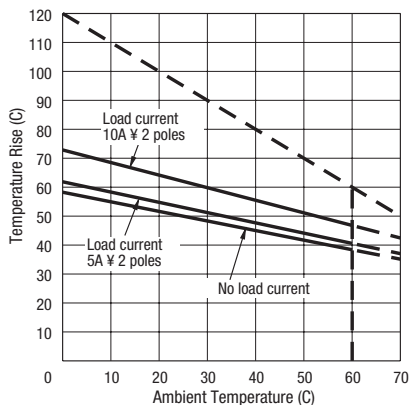

RU2 (AC Coil, 60 Hz)

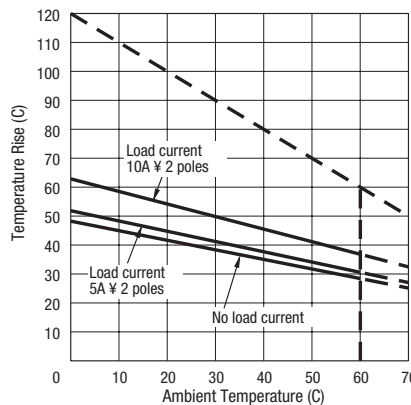

RU2 (DC Coil)

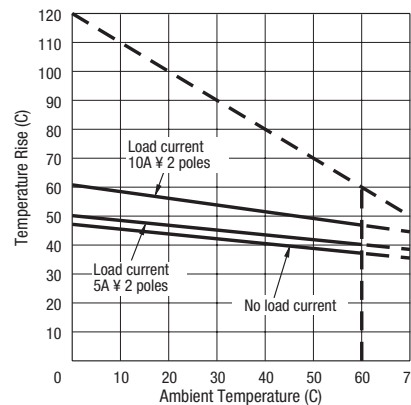

RU4/RU42 (AC Coil, 50 Hz)

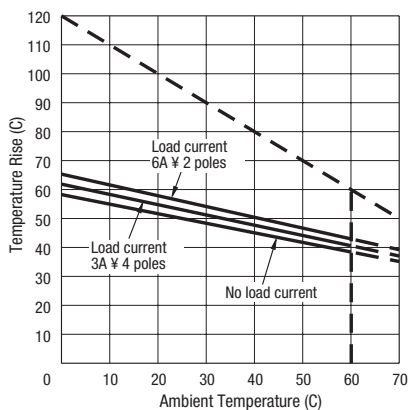

RU4/RU42 (AC Coil, 60 Hz)

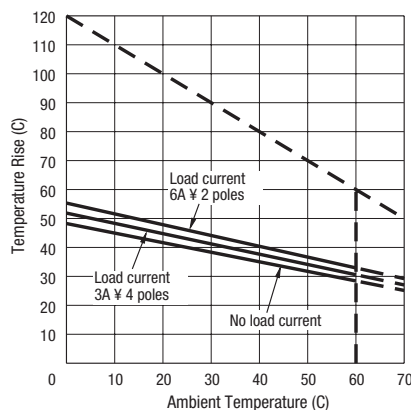

RU4/RU42 (DC Coil)

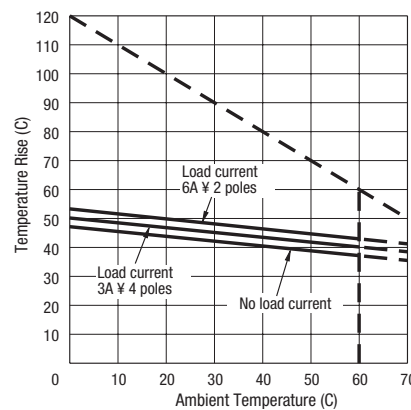

The above temperature rise curves show the characteristics when 100% the rated coil voltage is applied. The heat resistance of the coil is 120°C. The slant dashed line indicates the allowable temperature rise for the coil at different ambient temperatures. Load current 6A x 2 poles is for the RU4 models only.

Internal Connection (View from Bottom)

RU2S-* Standard

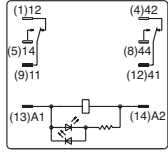

24V AC/DC coil or less

RU2S-*R with RC

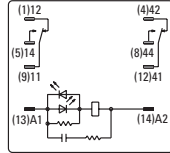

RU2S-*D With Diode

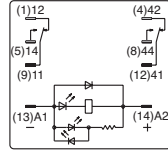

24V DC coil or less

RU2V-NF-*

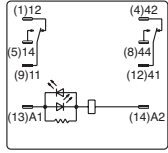
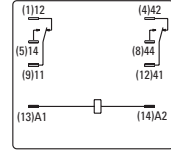

Over 24V AC/DC coil

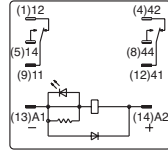

Over 24V DC coil

RU4S-*/RU42S-* Standard

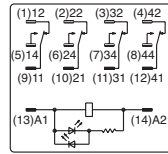

24V AC/DC coil or less

RU4S-*R/RU42S-*R With RC

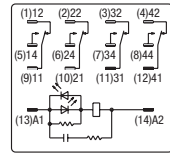

RU4S-*D/RU42S-*D With Diode

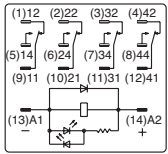

24V DC coil or less

RU4V-NF-*/RU42V-NF-*

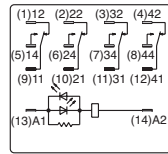
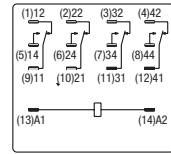

Over 24V AC/DC coil

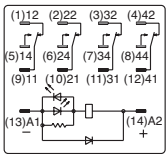

Over 24V DC coil

Dimensions (mm)

RU2S

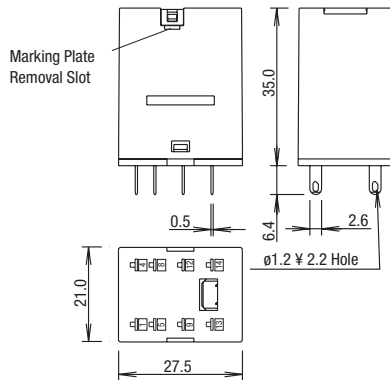

RU2V

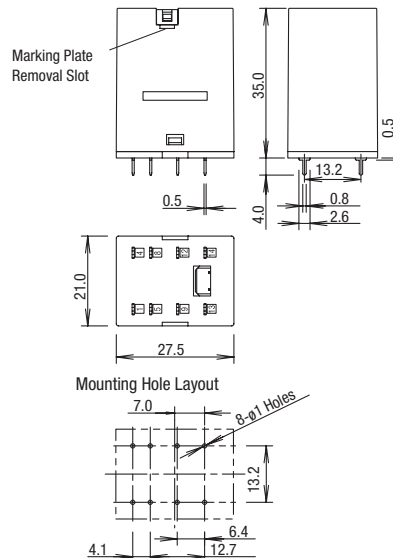

All dimensions in mm.

Switches & Pilot Lights

Signaling Lights

Relays & Sockets

Timers

Contactors

Terminal Blocks

Circuit Breakers

Dimensions con't (mm)

RU4S/RU42S

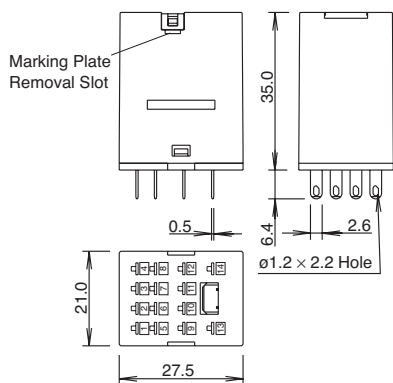

RU4V/RU42V

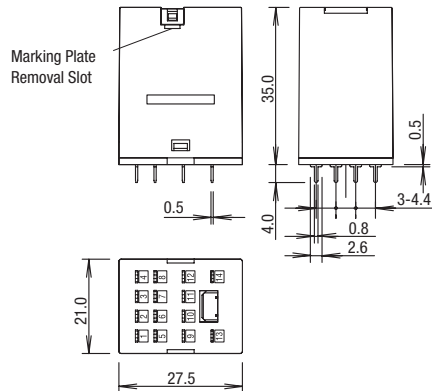

Marking plate removal slot is provided only on one side. Insert a flat screwdriver into the slot to remove the marking plate.

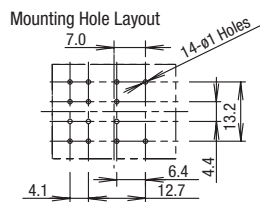

All dimensions in mm.

Spring Clamp DIN Rail Mount Sockets

SU2S-11L

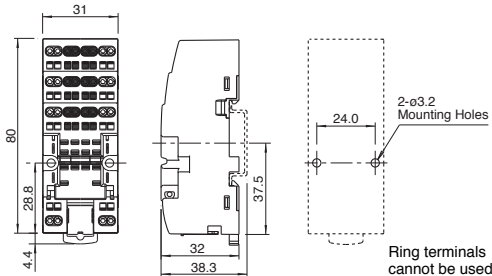

Terminal Arrangement

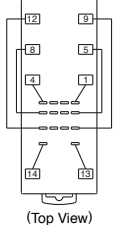

SU4S-11L

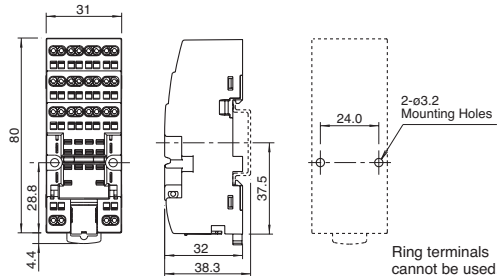

Terminal Arrangement

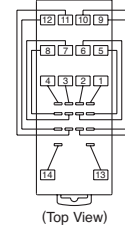

Standard DIN Rail Mount Sockets

SM2S-05

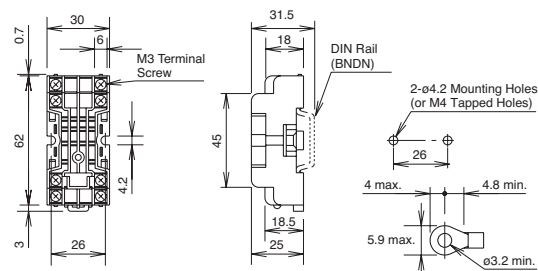

Terminal Arrangement

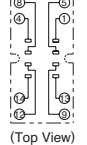

SY4S-05

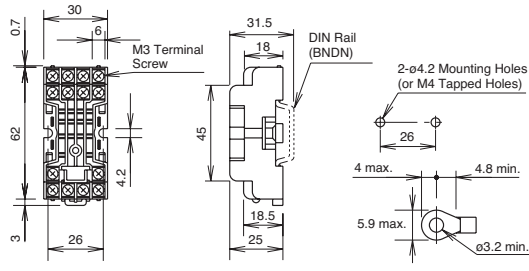

Terminal Arrangement

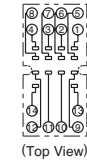

Switches & Pilot Lights

Signaling Lights

Relays & Sockets

Timers

Contactors

Terminal Blocks

Circuit Breakers

Dimensions con't (mm)

Finger-safe DIN Rail Mount Sockets

SM2S-05C

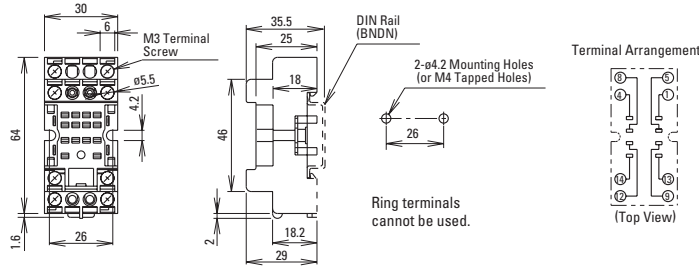

SY4S-05C

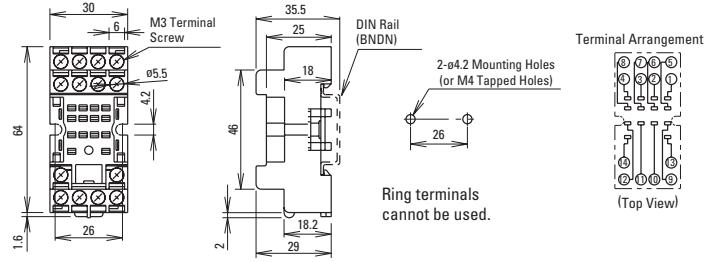

PCB Mount Sockets

SM2S-61

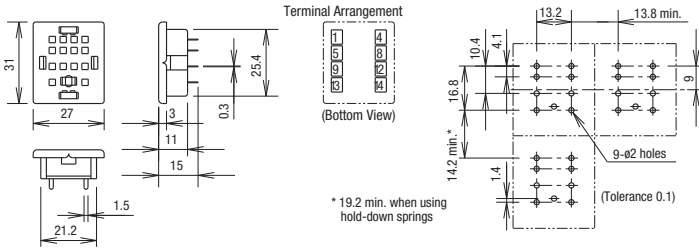

SM2S-62

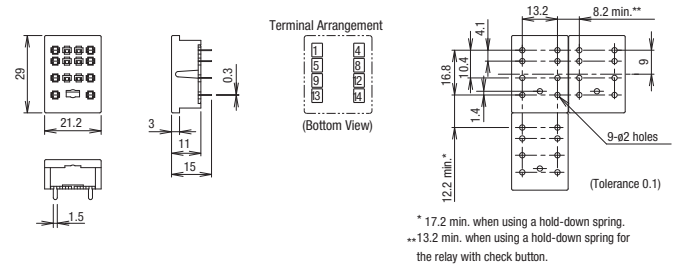

SY4S-61

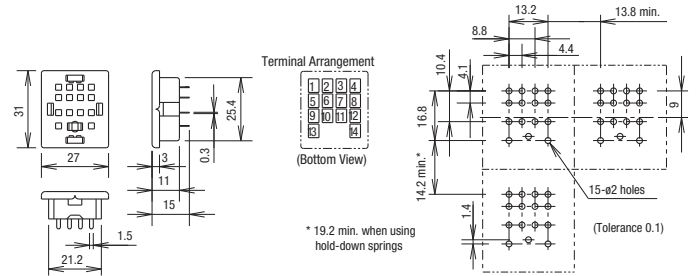

SY4S-62

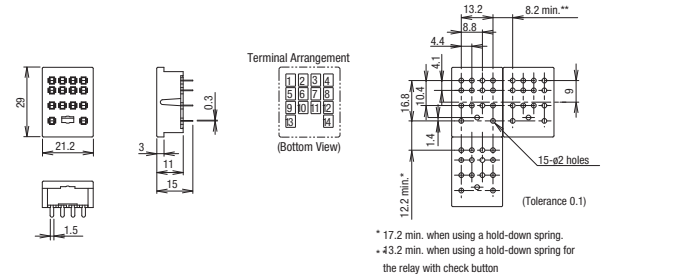

Through Panel Mount Socket

SY4S-51

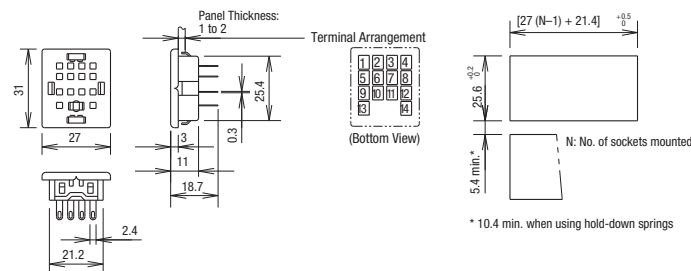

Switches & Pilot Lights

Signaling Lights

Relays & Sockets

Timers



Contactors

Terminal Blocks



Circuit Breakers

Looking for pricing, stock, or lifecycle information?

Click below to explore more details on WIN SOURCE:

-  [View RU4S-D24 on WIN SOURCE](#)
-  [IDEC Information](#)

Optimize Your Supply Chain with WIN SOURCE Solutions

-  Global Sourcing Solution
-  Obsolete Management
-  Cost Control Management
-  Shortage Management
-  Alternative Solution
-  Excess Inventory Management