



**THE DATASHEET OF
RCLAMP3328P.TNT**



PROTECTION PRODUCTS - RailClamp®

Description

The RClamp®3328P provides low voltage ESD protection for high-speed ports. It features a high maximum ESD withstand voltage of $\pm 25\text{kV}$ contact and $\pm 30\text{kV}$ air discharge per IEC 61000-4-2. RClamp3328P is designed to minimize both the ESD peak clamping and the TLP clamping. Peak ESD clamping voltage is extremely low and approximately the same at each pin. The dynamic resistance is among the industry's lowest at 0.35 Ohms (typical). Maximum capacitance on each line to ground is 0.65pF. This allows the RClamp3328P to be used in applications operating in excess of 5GHz without signal attenuation. These devices are manufactured using Semtech's proprietary low voltage EPD technology for superior characteristics at operating voltages up to 3.3 volts. Each device will protect up to eight lines (four high-speed pairs).

The RClamp3328P is in a 9-pin SGP3810N9 package. It measures 3.8 x 1.0mm with a nominal height of 0.50mm. Intra-pair lead pitch is 0.40mm while the pair-to-pair pitch is 0.5mm. The innovative flow through package design simplifies pcb layout and allows matched trace lengths for consistent impedance between high speed differential lines.

The combination of low peak ESD clamping, low dynamic resistance, and innovative package design enables this device provides the highest level of ESD protection for applications such as USB 3.0, HDMI and V-By-One interfaces.

Dimensions

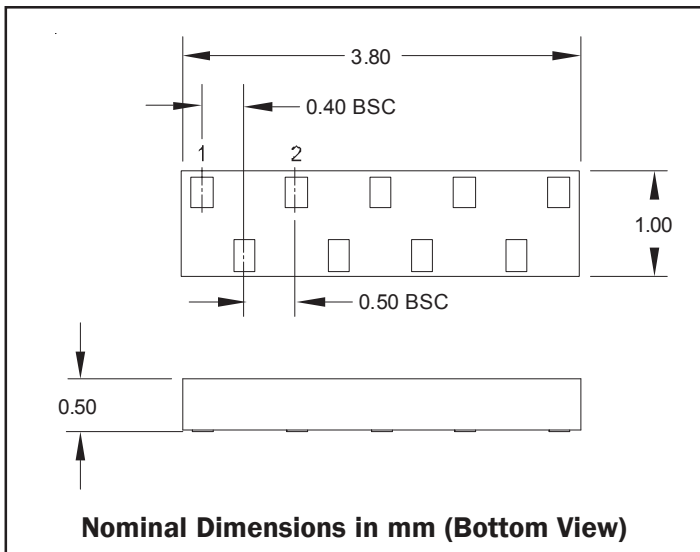

Features

- ◆ ESD protection for high-speed data lines to **IEC 61000-4-2 (ESD) $\pm 30\text{kV}$ (air), $\pm 25\text{kV}$ (contact)**
- ◆ **IEC 61000-4-5 (Lightning) 5A (8/20 μs)**
- ◆ **IEC 61000-4-4 (EFT) 40A (5/50ns)**
- ◆ Package design optimized for high speed lines
- ◆ Flow-Through design
- ◆ Protects eight high-speed lines
- ◆ Low capacitance: **0.65pF** Maximum (I/O to Ground)
- ◆ Low ESD clamping voltage
- ◆ Low dynamic resistance: 0.35 Ohms (Typ)
- ◆ Solid-state silicon-avalanche technology

Mechanical Characteristics

- ◆ SGP3810N9 9-pin package (3.8 x 1.0 x 0.50mm)
- ◆ Pb-Free, Halogen Free, RoHS/WEEE Compliant
- ◆ Lead Pitch: 0.4mm (intra-pair), 0.50mm (pair-to-pair)
- ◆ Lead finish: NiPdAu
- ◆ Marking: Marking Code
- ◆ Packaging: Tape and Reel

Applications

- ◆ HDMI 1.3/1.4
- ◆ V-By-One
- ◆ USB 3.0
- ◆ eDP
- ◆ MHL
- ◆ LVDS Interfaces
- ◆ eSATA Interfaces

Circuit Diagram

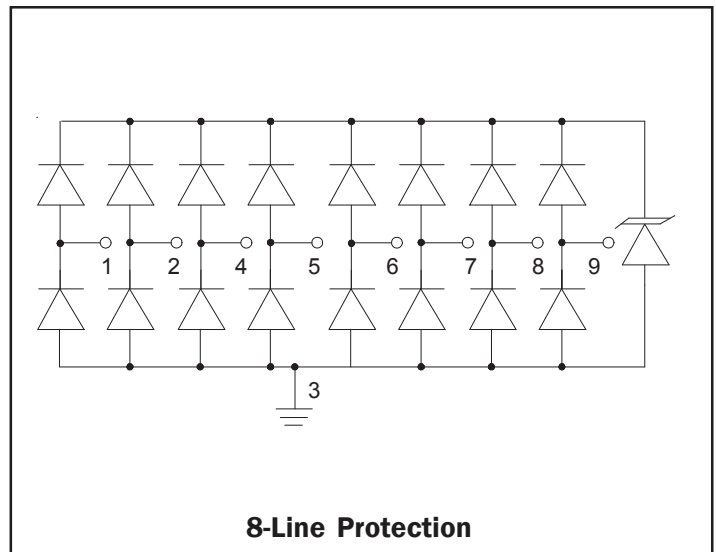

PROTECTION PRODUCTS
Absolute Maximum Rating

Rating	Symbol	Value	Units
Peak Pulse Power (tp = 8/20μs)	P_{pk}	75	Watts
Peak Pulse Current (tp = 8/20μs)	I_{pp}	5	A
ESD per IEC 61000-4-2 (Air) ¹ ESD per IEC 61000-4-2 (Contact) ¹	V_{ESD}	+/- 30 +/- 25	kV
Operating Temperature	T_J	-55 to +125	°C
Storage Temperature	T_{STG}	-55 to +150	°C

Electrical Characteristics (T=25°C)

Parameter	Symbol	Conditions	Minimum	Typical	Maximum	Units
Reverse Stand-Off Voltage	V_{RWM}	Any I/O to GND			3.3	V
Punch-Through Voltage	V_{PT}	$I_{PT} = 2\mu A$ Any I/O to GND	3.8	4.8	5.5	V
Reverse Leakage Current	I_R	$V_{RWM} = 3.3V$, Any I/O to GND		0.005	0.100	μA
Clamping Voltage	V_C	$I_{pp} = 1A$, tp = 8/20μs Any I/O to GND		5.2	7	V
Clamping Voltage	V_C	$I_{pp} = 5A$, tp = 8/20μs Any I/O to GND		8.2	10.5	V
ESD Clamping Voltage ²	V_C	IPP = 16A, t _{lp} = 0.2/100ns		11.8		V
ESD Clamping Voltage ²	V_C	IPP = -16A, t _{lp} = 0.2/100ns		11.7		V
Dynamic Resistance (Positive) ^{2,3}	R_D	tp = 100ns		0.35		Ohms
Dynamic Resistance(negative) ^{2,3}	R_D	tp = 100ns		0.50		Ohms
Junction Capacitance	C_J	$V_R = 0V$, f = 1MHz, Any I/O to GND		0.40	0.65	pF
		$V_R = 0V$, f = 1MHz, Between I/O pins		0.30	0.4	pF

Notes

- 1) Measured with a 20dB attenuator, 50 Ohm scope input impedance, 2GHz bandwidth. ESD gun return path connected to ESD ground plane.
- 2) Transmission Line Pulse Test (TLP) Settings: t_p = 100ns, t_r = 0.2ns, I_{TLP} and V_{TLP} averaging window: t₁ = 70ns to t₂ = 90ns.
- 3) Dynamic resistance calculated from I_{TLP} = 4A to I_{TLP} = 16A

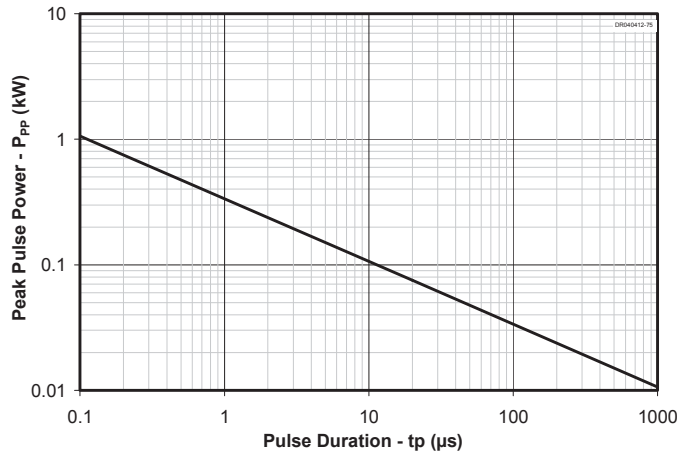
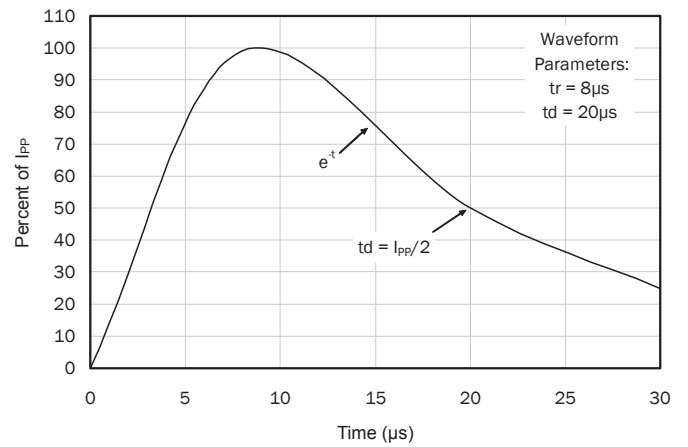
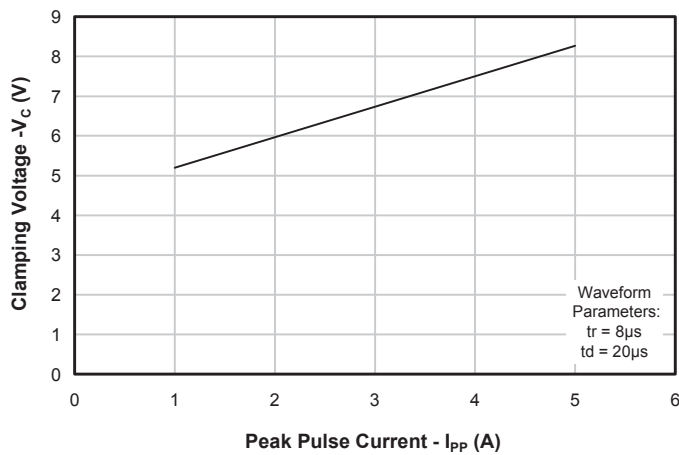
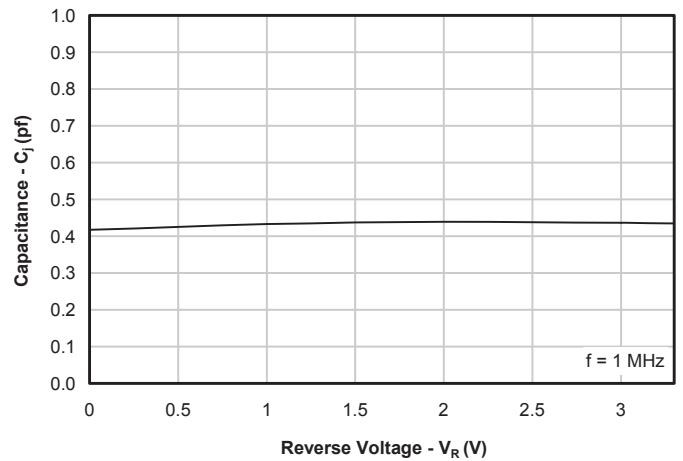
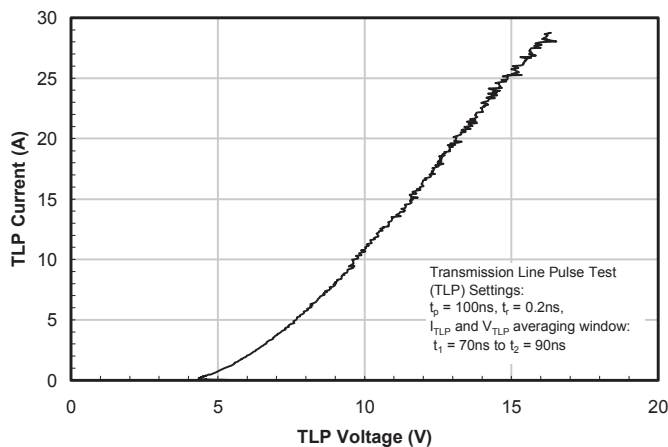
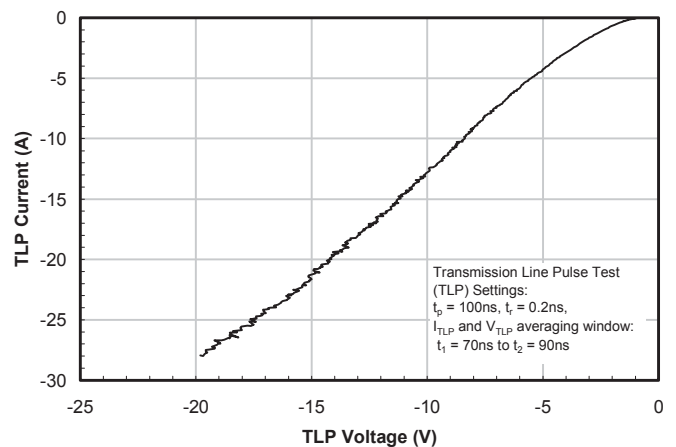
PROTECTION PRODUCTS
Typical Characteristics
Non-Repetitive Peak Pulse Power vs. Pulse Time

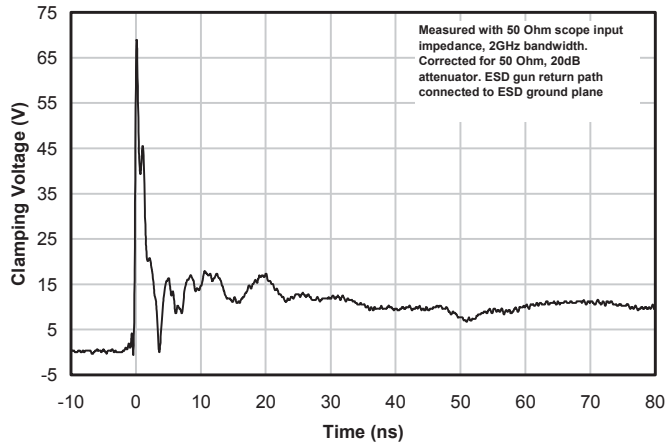
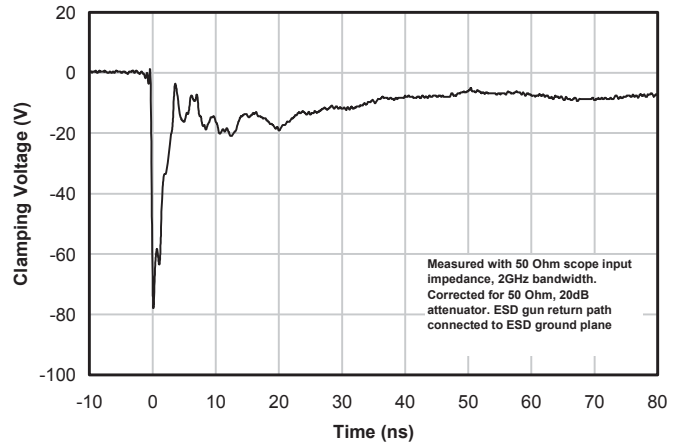
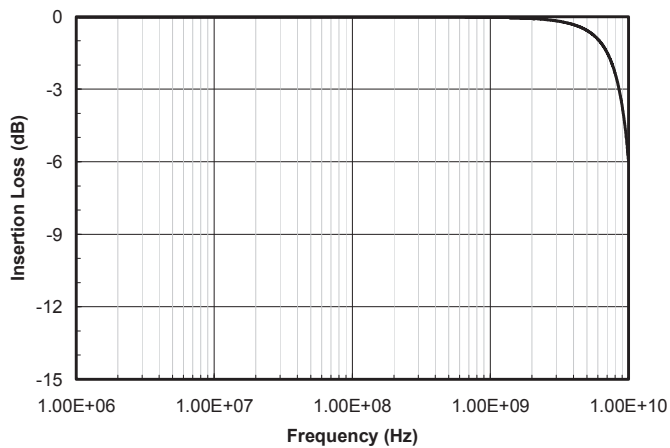
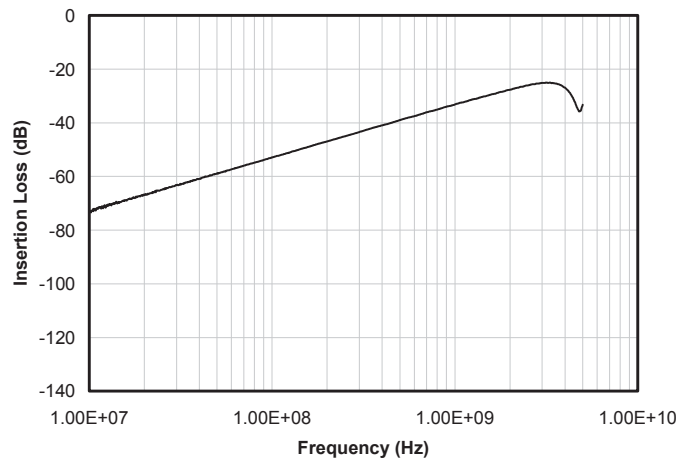
8/20us Pulse Waveform

**Clamping Voltage vs. Peak Pulse Current
(Between any I/O and Ground)**

**Junction Capacitance vs. Reverse Voltage
(Between any I/O and Ground)**

TLP Characteristic (Positive)

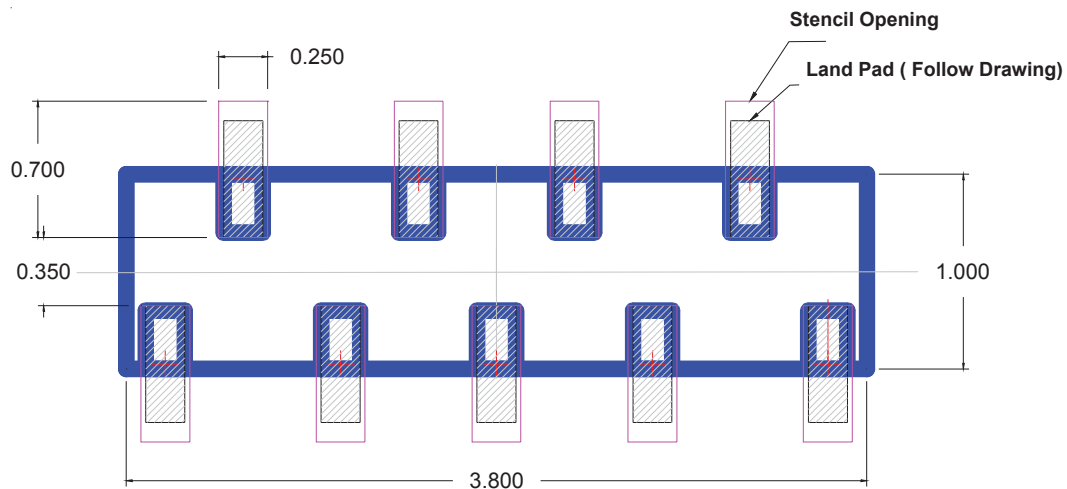
TLP Characteristic (Negative)

PROTECTION PRODUCTS
Typical Characteristics (Con't)
**ESD Clamping (+8kV Contact per IEC 61000-4-2)
(Between any I/O and Ground)**

**ESD Clamping (-8kV Contact per IEC 61000-4-2)
(Between any I/O and Ground)**

Typical Insertion Loss S21

Analog Crosstalk

PROTECTION PRODUCTS
Applications Information
Assembly Guidelines

The small size of this device means that some care must be taken during the mounting process to insure reliable solder joint. Semtech's recommended assembly guidelines for mounting this device are shown in the Table. The figure below details Semtech's recommended aperture based on the below recommendations. Note that these are only recommendations and should serve only as a starting point for design since there are many factors that affect the assembly process. The exact manufacturing parameters will require some experimentation to get the desired solder application.

Assembly Parameter	Recommendation
Solder Stencil Design	Laser cut, Electro-polished
Aperture shape	Rectangular with rounded corners
Solder Stencil Thickness	0.100 mm (0.004")
Solder Paste Type	Type 4 size sphere or smaller
Solder Reflow Profile	Per JEDEC J-STD-020
PCB Solder Pad Design	Non-Solder mask defined
PCB Pad Finish	OSP OR NiAu



All Dimensions are in mm.

 Land Pad.
  Stencil opening
  Component

Recommended Mounting Pattern

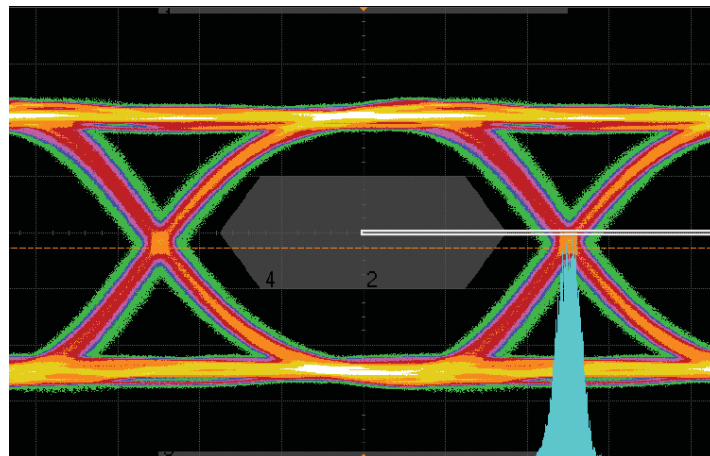
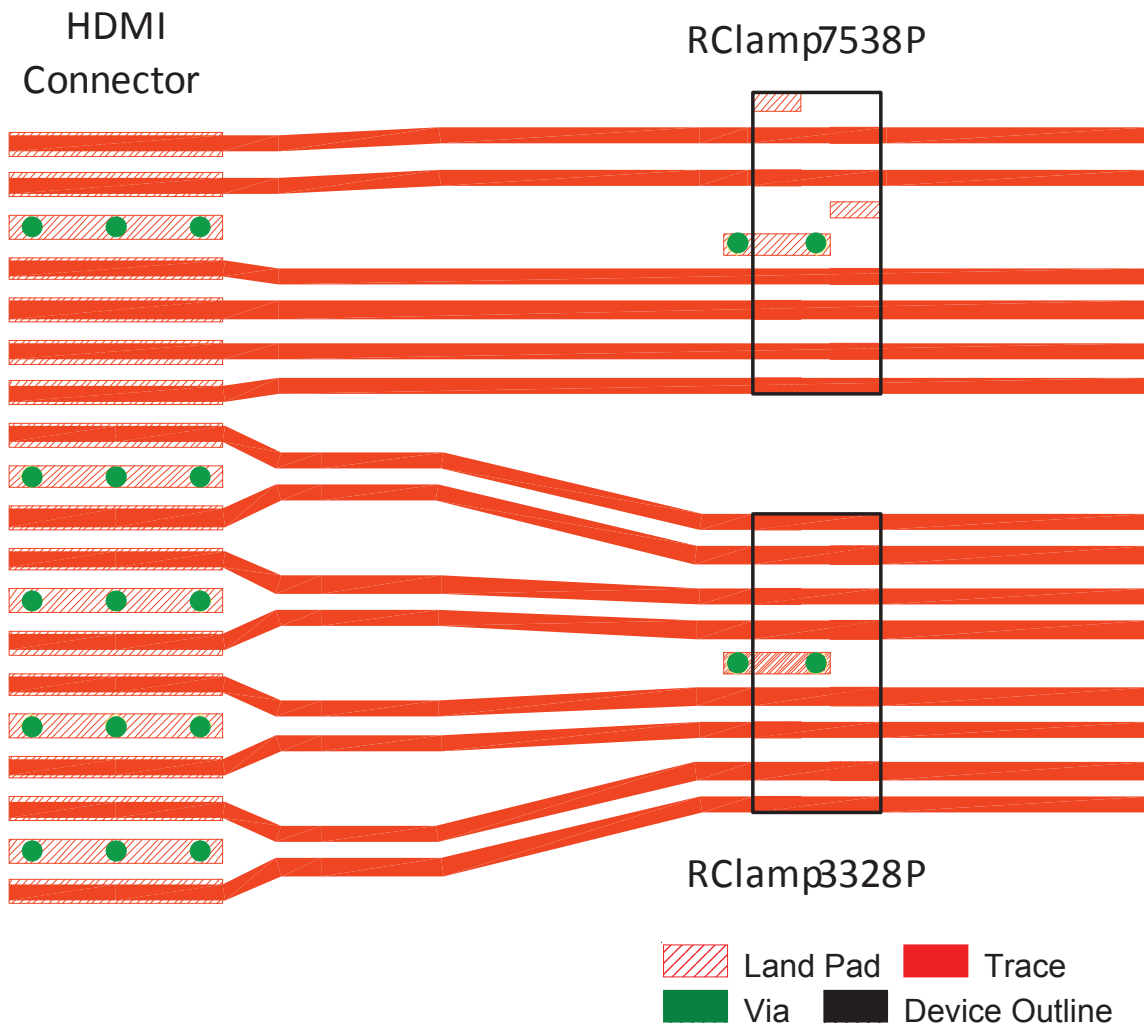
HDMI 1.4 Layout and Eye Diagram with RClamp3328P

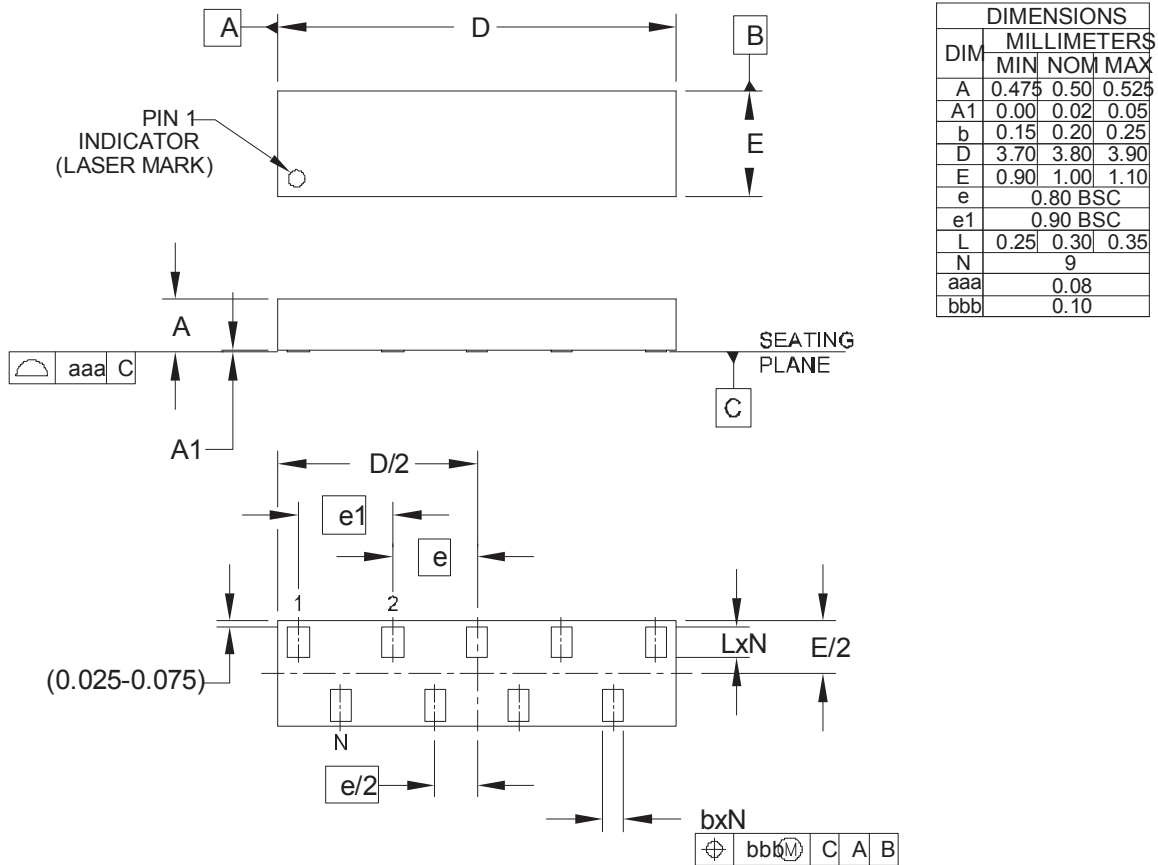
PROTECTION PRODUCTS
Outline Drawing - SGP3810N9

- NOTES:
1. CONTROLLING DIMENSIONS ARE IN MILLIMETERS (ANGLES IN DEGREES).

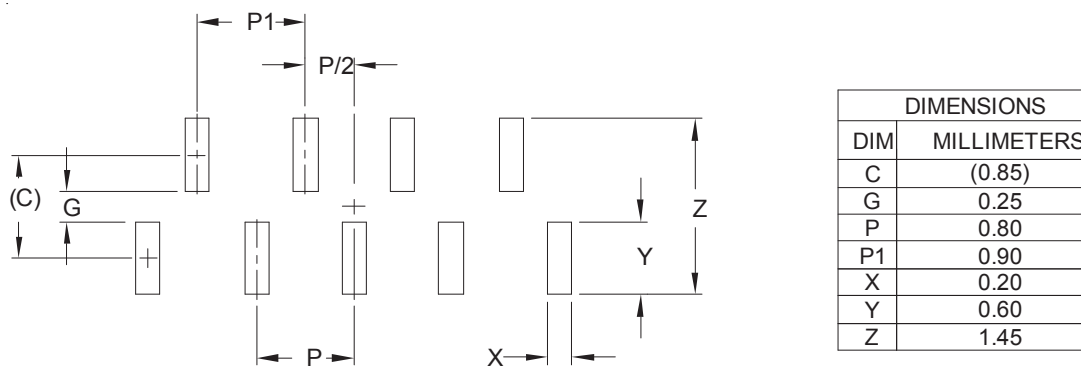
Land Pattern - SGP3810N9



- NOTES:
1. CONTROLLING DIMENSIONS ARE IN MILLIMETERS (ANGLES IN DEGREES).
 2. THIS LAND PATTERN IS FOR REFERENCE PURPOSES ONLY
CONSULT YOUR MANUFACTURING GROUP TO ENSURE YOUR
COMPANY'S MANUFACTURING GUIDELINES ARE MET

Contact Information

Semtech Corporation
Protection Products Division
200 Flynn Road, Camarillo, CA 93012
Phone: (805)498-2111 FAX (805)498-3804

Looking for pricing, stock, or lifecycle information?

Click below to explore more details on WIN SOURCE:

-  [View RCLAMP3328P.TNT on WIN SOURCE](#)
-  [Semtech Corporation](#) Information

Optimize Your Supply Chain with WIN SOURCE Solutions

-  Global Sourcing Solution
-  Obsolete Management
-  Cost Control Management
-  Shortage Management
-  Alternative Solution
-  Excess Inventory Management