



**THE DATASHEET OF
PS9821-1-V-F3-AX**



PS9821-1,-2

HIGH CMR, 15 Mbps OPEN COLLECTOR OUTPUT TYPE
8-PIN SSOP (SO-8) 3.3 V HIGH-SPEED PHOTOCOUPLER

R08DS0260EJ0100
Rev.1.00
Dec 17, 2021

DESCRIPTION

The PS9821-1 and PS9821-2 are active-low type high-speed photocouplers that use an AlGaAs light-emitting diode on the input side and a photodetector IC that includes a photodiode and a signal processor on the same chip on the output side.

The PS9821-1, -2 are designed specifically for high common mode transient immunity (CMR) and low pulse width distortion, PS9821-2 is suitable for high density applications.

FEATURES

- Low power consumption ($V_{CC} = 3.3\text{ V}$)
- Pulse width distortion ($|t_{PHL}-t_{PLH}| = 35\text{ ns MAX.}$)
- High common mode transient immunity ($CM_H, CM_L = \pm 15\text{ kV}/\mu\text{s MIN.}$)
- 40% reduction of mounting area (5-pin SOP \times 2)
- High-speed (15 Mbps)
- High isolation voltage ($BV = 2\ 500\text{ Vr.m.s.}$)
- Open collector output
- Ordering number of tape product: PS9821-1-F3 : 1 500 pcs/reel
: PS9821-2-F3 : 1 500 pcs/reel
- Pb-Free product
- Safety standards
 - UL : UL1577, Single protection
 - CSA : CAN/CSA-C22.2 No.62368-1, Basic insulation
 - VDE : DIN EN 60747-5-5 (Option)

APPLICATIONS

- Measurement equipment
- PDP
- FA Network

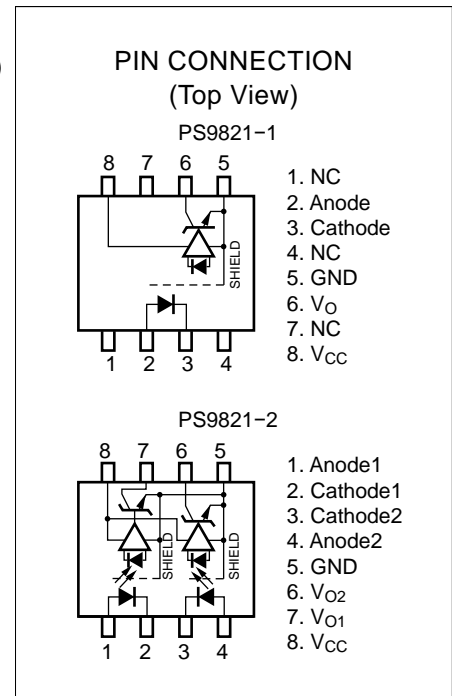

TRUTH TABLE

LED	Output
ON	L
OFF	H

Start of mass production
Sep.2004

PACKAGE DIMENSIONS (UNIT: mm)

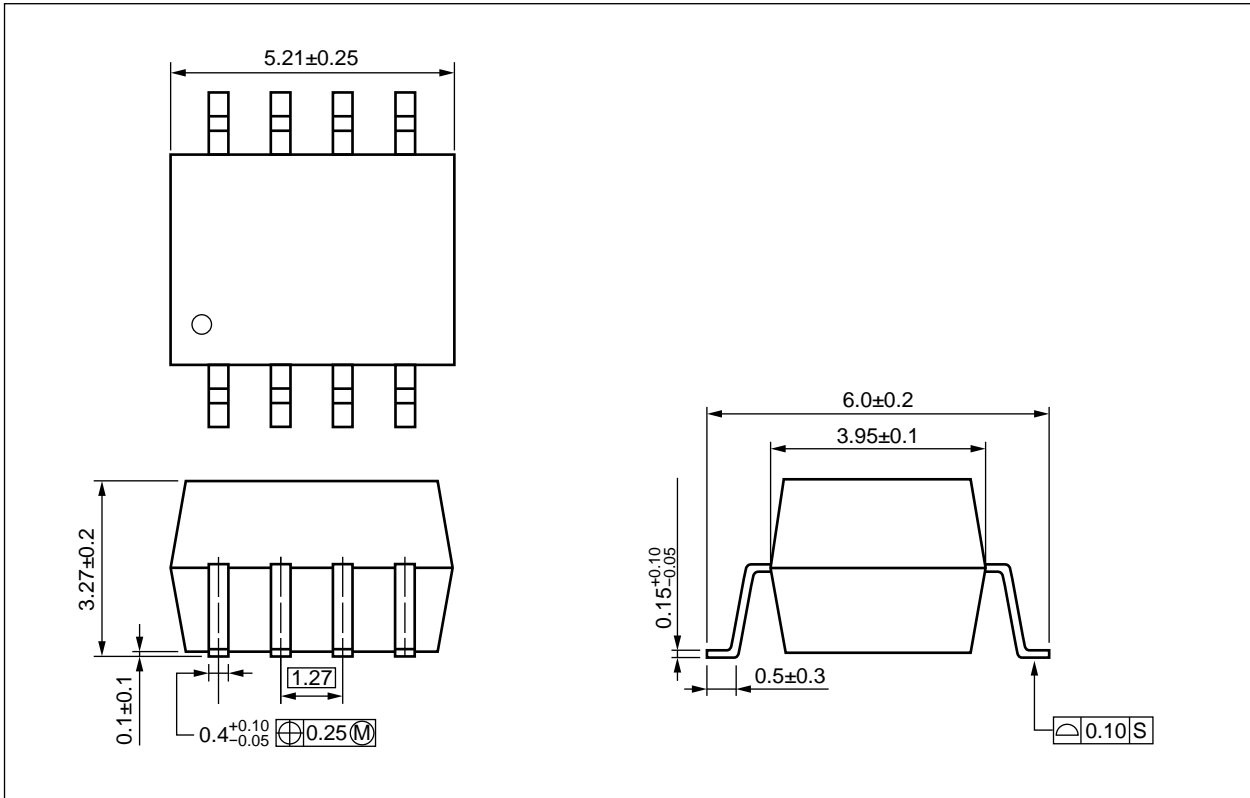

Weight: 0.14g (typ.)

PHOTOCOUPLER CONSTRUCTION

Parameter	Unit (MIN.)
Air Distance	4 mm
Creepage Distance	4 mm
Isolation Distance	0.2 mm

MARKING EXAMPLE

Ni/Pd/Au PLATING

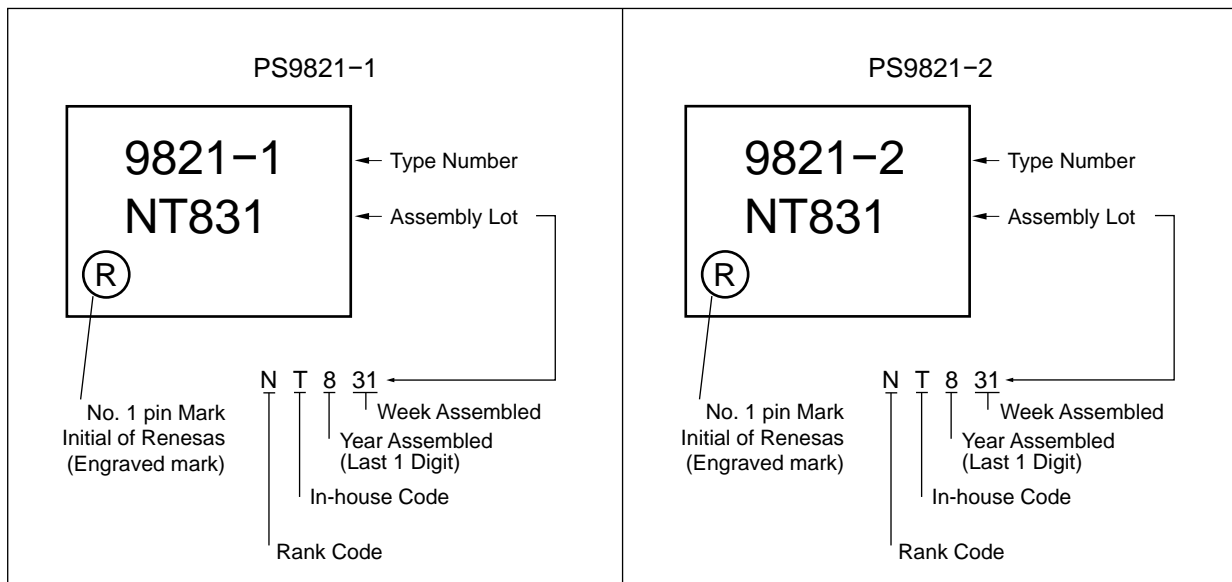

ORDERING INFORMATION

Part Number	Order Number	Solder Plating Specification	Packing Style	Safety Standard Approval	Application Part Number ^{*1}
PS9821-1	PS9821-1-AX	Pb-Free (Ni/Pd/Au)	20 pcs (Tape 20 pcs cut)	Standard products (UL, CSA approved)	PS9821-1
PS9821-1-F3	PS9821-1-F3-AX		Embossed Tape 1 500 pcs/reel		
PS9821-2	PS9821-2-AX		20 pcs (Tape 20 pcs cut)		PS9821-2
PS9821-2-F3	PS9821-2-F3-AX		Embossed Tape 1 500 pcs/reel		
PS9821-1-V	PS9821-1-V-AX		20 pcs (Tape 20 pcs cut)	UL, CSA, DIN EN 60747-5-5 approved	PS9821-1
PS9821-1-V-F3	PS9821-1-V-F3-AX		Embossed Tape 1 500 pcs/reel		
PS9821-2-V	PS9821-2-V-AX		20 pcs (Tape 20 pcs cut)		PS9821-2
PS9821-2-V-F3	PS9821-2-V-F3-AX		Embossed Tape 1 500 pcs/reel		

Notes*: 1. For the application of the Safety Standard, following part number should be used.

ABSOLUTE MAXIMUM RATINGS (T_A = 25 °C, unless otherwise specified)

Parameter		Symbol	Ratings		Unit
			PS9821-1	PS9821-2	
Diode	Forward Current	I _F	20 ^{*1}	15 ^{*2}	mA
	Reverse Voltage	V _R	5		V/ch
Detector	Supply Voltage	V _{CC}	7		V
	Output Voltage	V _O	7		V/ch
	Output Current	I _O	25		mA/ch
	Power Dissipation ^{*3}	P _C	40		mW/ch
Isolation Voltage ^{*4}		BV	2 500		Vr.m.s.
Operating Ambient Temperature		T _A	- 40 to + 85		°C
Storage Temperature		T _{stg}	- 55 to + 125		°C

- Notes*: 1. Reduced to 0.3 mA/°C at T_A = 60 °C or more.
 2. Reduced to 0.1 mA/°C at T_A = 60 °C or more.
 3. Applies to output pin V_O (collector pin). Reduced to 1.5 mW/°C at T_A = 65 °C or more.
 4. AC voltage for 1 minute at T_A = 25 °C, RH = 60 % between input and output.
 Pins 1-4 shorted together, 5-8 shorted together.

RECOMMENDED OPERATING CONDITIONS

Parameter	Symbol	MIN.	TYP.	MAX.	Unit
Low Level Input Voltage	V _{FL}	0		0.8	V
High Level Input Current	I _{FH}	6.3	10	12.5	mA
Supply Voltage	V _{CC}	2.7		3.6	V
Pull-up Resistance	R _L	330		4 k	Ω
TLL (R _L = 1.0 kΩ, loads)	N			5	

ELECTRICAL CHARACTERISTICS (1/2) (T_A = -40 to +85 °C, unless otherwise specified)

Parameter		Symbol	Conditions	MIN.	TYP. *1	MAX.	Unit	
Diode	Forward Voltage	V _F	I _F = 10 mA, T _A = 25 °C	1.4	1.65	1.8	V	
	Reverse Current	I _R	V _R = 3.0 V, T _A = 25 °C			10	μA	
	Terminal Capacitance	C _t	V _F = 0 V, f = 1 MHz, T _A = 25 °C		30		pF	
Detector	High Level Output Current	I _{OH}	V _{CC} = V _O = 3.3 V, I _F = 0.8 mA		1	80	μA	
			V _{CC} = V _O = 5.5 V, I _F = 0.8 mA		1 ^{*2}			
	Low Level Output Voltage *3	V _{OL}	V _{CC} = 3.3 V, I _F = 5.0 mA, I _{OL} = 13 mA		0.2	0.6	V	
			V _{CC} = 5.5 V, I _F = 5.0 mA, I _{OL} = 13 mA		0.2 ^{*2}			
	High Level Supply Current (PS9821-1)	I _{CCH}	V _{CC} = 3.3 V, I _F = 0 mA, V _O = open		4	7	mA	
			V _{CC} = 5.5 V, I _F = 0 mA, V _O = open		5 ^{*2}			
	High Level Supply Current (PS9821-2)	I _{CCH}	V _{CC} = 3.3 V, I _F = 0 mA, V _O = open		8	14	mA	
			V _{CC} = 5.5 V, I _F = 0 mA, V _O = open		10 ^{*2}			
	Low Level Supply Current (PS9821-1)	I _{CCL}	V _{CC} = 3.3 V, I _F = 10 mA, V _O = open		7	10	mA	
			V _{CC} = 5.5 V, I _F = 10 mA, V _O = open		9 ^{*2}			
Low Level Supply Current (PS9821-2)	I _{CCL}	V _{CC} = 3.3 V, I _F = 10 mA, V _O = open		14	20	mA		
		V _{CC} = 5.5 V, I _F = 10 mA, V _O = open		18 ^{*2}				
Coupled	Threshold Input Current (H → L)	I _{FHL}	V _{CC} = 3.3 V, V _O = 0.8 V, R _L = 350 Ω		2.5	5	mA	
			V _{CC} = 5 V, V _O = 0.8 V, R _L = 350 Ω		2.5 ^{*2}			
	Isolation Resistance	R _{I-O}	V _{I-O} = 1 kV _{DC} , RH = 40 to 60 %, T _A = 25 °C		10 ¹¹		Ω	
	Insulation Resistance (Input-Input), (PS9821-2)	R _{I-I}	V _{I-I} = 1 kV _{DC} , RH = 40 to 60 %, T _A = 25 °C		10 ¹⁰		Ω	
	Isolation Capacitance	C _{I-O}	V = 0 V, f = 1 MHz, T _A = 25 °C		0.6		pF	
	Insulation Capacitance (Input-Input), (PS9821-2)	C _{I-I}	V = 0 V, f = 1 MHz, T _A = 25 °C		0.3		pF	
	Propagation Delay Time (H → L) *4	t _{PHL}		T _A = 25 °C		45	75	ns
			V _{CC} = 3.3 V, R _L = 350 Ω, I _F = 7.5 mA				100	
			V _{CC} = 5 V, R _L = 350 Ω, I _F = 7.5 mA			38 ^{*2}		
	Propagation Delay Time (L → H) *4	t _{PLH}		T _A = 25 °C		50	75	ns
			V _{CC} = 3.3 V, R _L = 350 Ω, I _F = 7.5 mA				100	
			V _{CC} = 5 V, R _L = 350 Ω, I _F = 7.5 mA			43 ^{*2}		
	Rise Time	t _r	V _{CC} = 3.3 V, R _L = 350 Ω, I _F = 7.5 mA			20		ns
V _{CC} = 5 V, R _L = 350 Ω, I _F = 7.5 mA					20 ^{*2}			
Fall Time	t _f	V _{CC} = 3.3 V, R _L = 350 Ω, I _F = 7.5 mA			5		ns	
		V _{CC} = 5 V, R _L = 350 Ω, I _F = 7.5 mA			5 ^{*2}			
Pulse Width Distortion (PWD) *4	t _{PLH} - t _{PHL}	V _{CC} = 3.3 V, R _L = 350 Ω, I _F = 7.5 mA			5	35	ns	
		V _{CC} = 5 V, R _L = 350 Ω, I _F = 7.5 mA			5 ^{*2}			
Propagation Delay Skew	t _{PSK}	V _{CC} = 3.3 V, R _L = 350 Ω, I _F = 7.5 mA				40	ns	

ELECTRICAL CHARACTERISTICS (2/2) (TA = -40 to +85 °C, unless otherwise specified)

Parameter		Symbol	Conditions	MIN.	TYP. *1	MAX.	Unit
Coupled	Common Mode Transient Immunity at High Level Output*5	CM _H	V _{CC} = 3.3 V, R _L = 350 Ω, T _A = 25 °C, I _F = 0 mA, V _O > 2 V, V _{CM} = 1 kV	15	20		kV/μs
			V _{CC} = 5 V, R _L = 350 Ω, T _A = 25 °C, I _F = 0 mA, V _O > 2 V, V _{CM} = 1 kV		20*2		
	Common Mode Transient Immunity at Low Level Output*5	CM _L	V _{CC} = 3.3 V, R _L = 350 Ω, T _A = 25 °C, I _F = 7.5 mA, V _O < 0.8 V, V _{CM} = 1 kV	15	20		
			V _{CC} = 5 V, R _L = 350 Ω, T _A = 25 °C, I _F = 7.5 mA, V _O < 0.8 V, V _{CM} = 1 kV		20*2		

Notes*: 1. Typical values at T_A = 25 °C

2. These values are reference values.

3. Because V_{OL} of 2 V or more may be output when LED current input and when output supply of V_{CC} = 2.6 V or less, it is important to confirm the characteristics (operation with the power supply on and off) during design, before using this device.

4. Test circuit for propagation delay time.

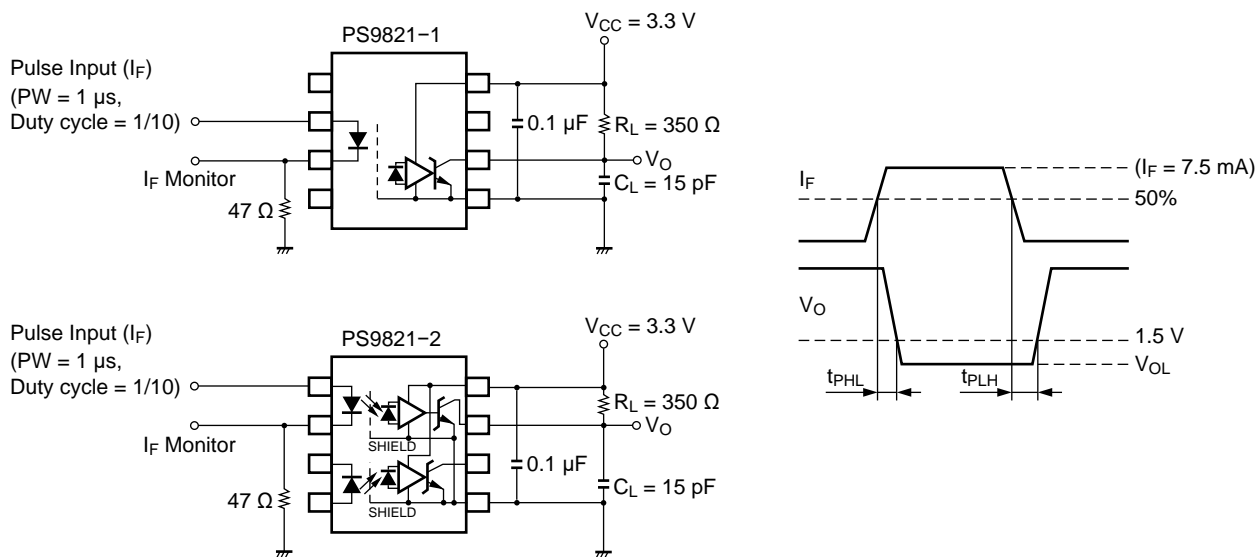

Remark: C_L includes probe and stray wiring capacitance.

5. Test circuit for common mode transient immunity

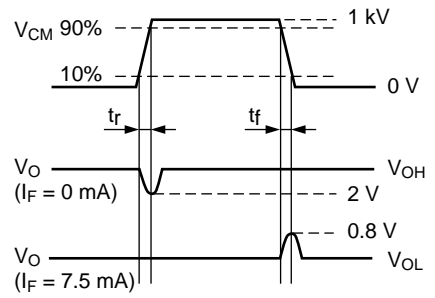
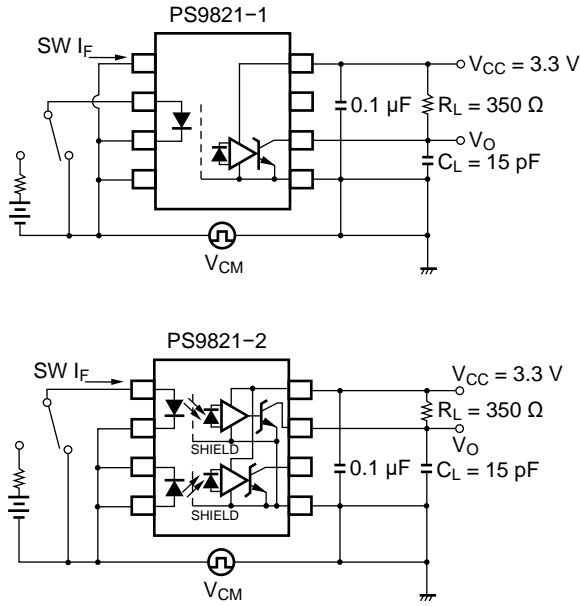

Remark: C_L includes probe and stray wiring capacitance.

USAGE CAUTIONS

1. This product is weak for static electricity by designed with high-speed integrated circuit so protect against static electricity when handling.
2. By-pass capacitor of 0.1 μF is used between V_{CC} and GND near device. Also, ensure that the distance between the leads of the photocoupler and capacitor is no more than 10 mm.
3. Avoid storage at a high temperature and high humidity.
4. Avoid cleaning with Freon based or halogen-based (chlorinated etc.) solvents.
5. Do not use fixing agents or coatings containing halogen-based substances.

TYPICAL CHARACTERISTICS ($T_A = 25\text{ }^\circ\text{C}$ unless otherwise specified)

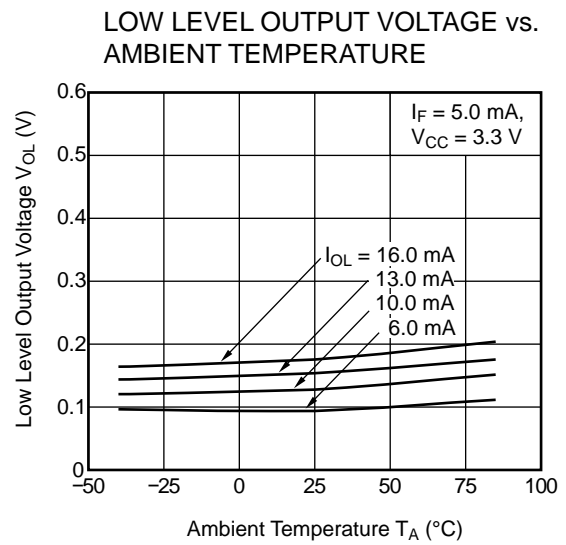
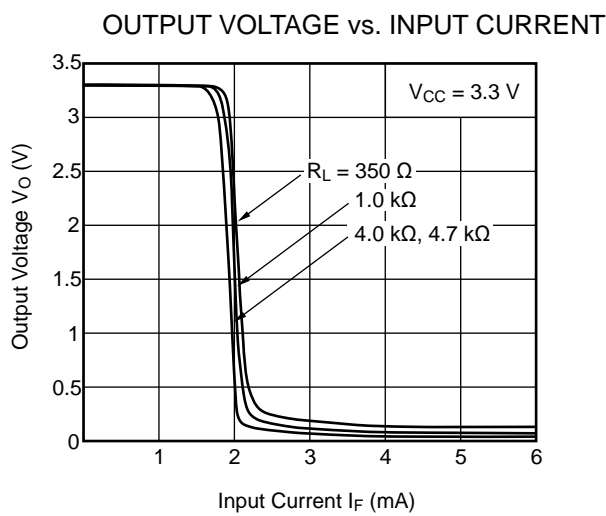
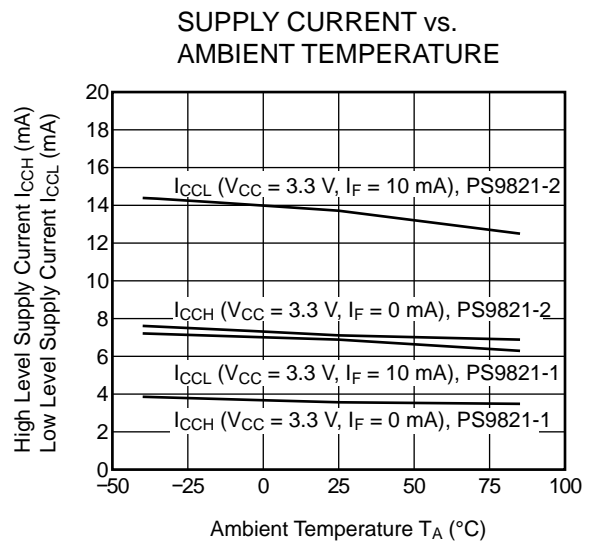
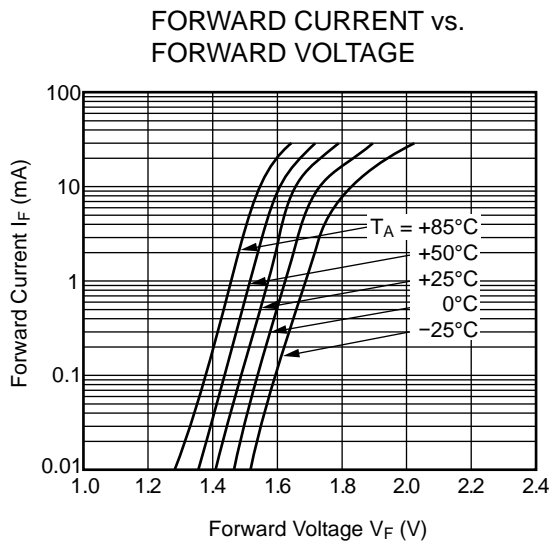
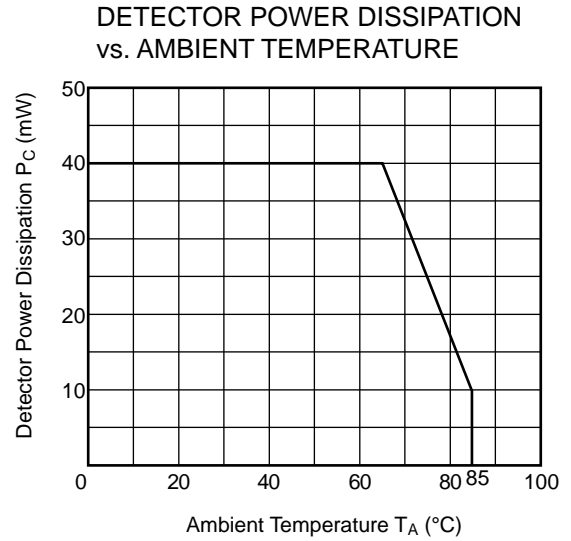
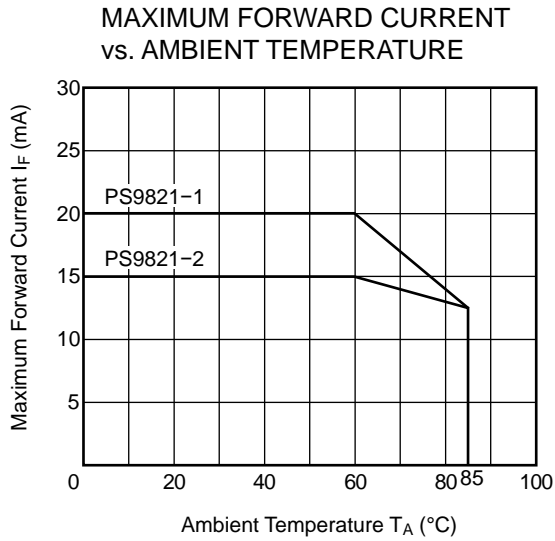

Remark The graphs indicate nominal characteristics.

THRESHOLD INPUT CURRENT vs. AMBIENT TEMPERATURE

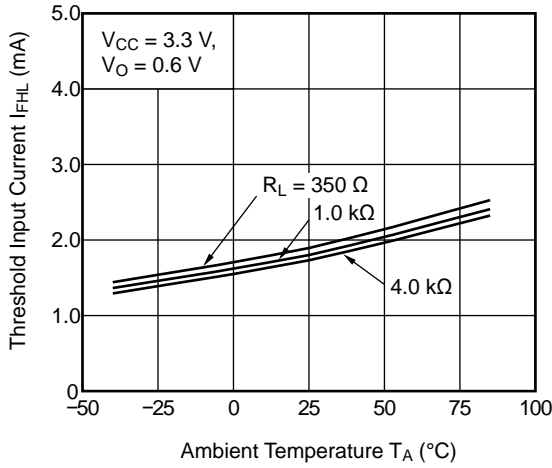

PROPAGATION DELAY TIME vs. AMBIENT TEMPERATURE

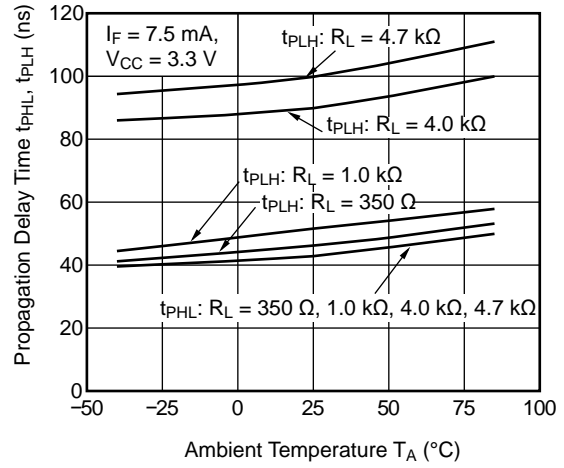

PULSE WIDTH DISTORTION vs. AMBIENT TEMPERATURE

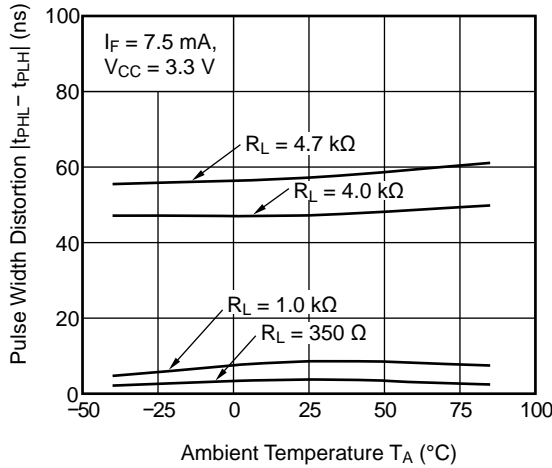

SWITCHING TIME vs. AMBIENT TEMPERATURE

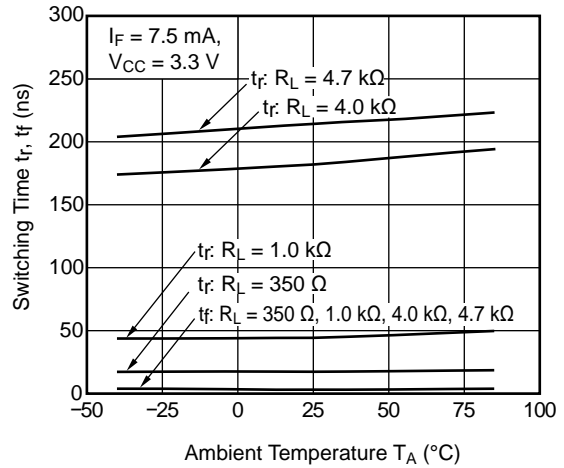

PROPAGATION DELAY TIME vs. INPUT CURRENT

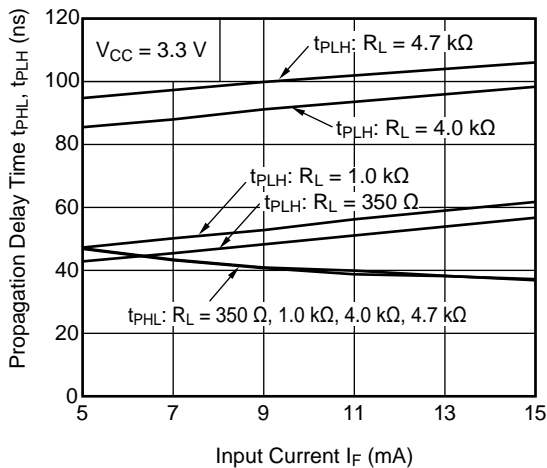

Remark The graphs indicate nominal characteristics.

TAPING SPECIFICATIONS (UNIT: mm)

Taping Direction

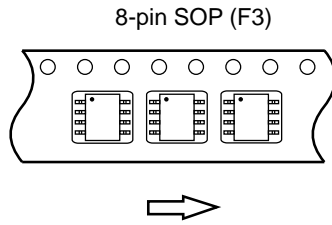

Outline and Dimensions (Tape)

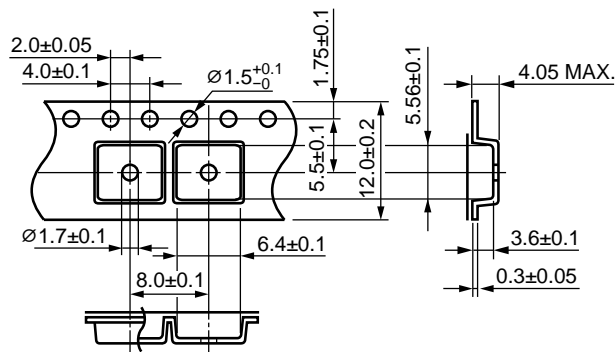

Outline and Dimensions (Reel)

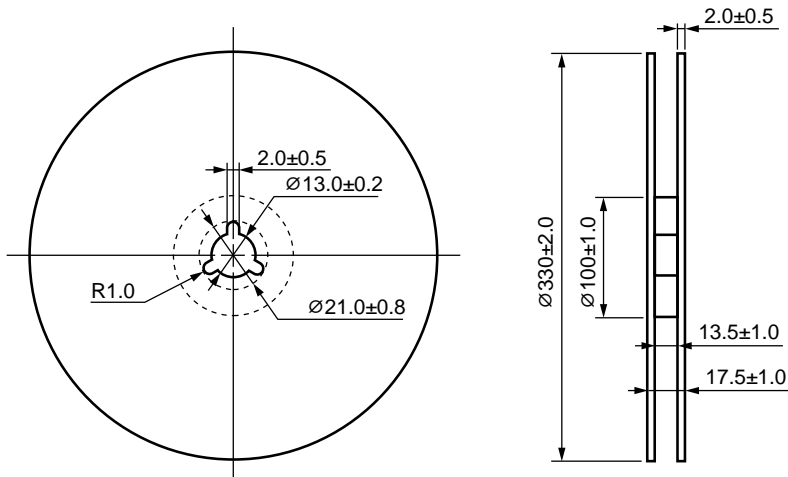

Packing: 1 500 pcs/reel

RECOMMENDED MOUNT PAD DIMENSIONS (UNIT: mm)

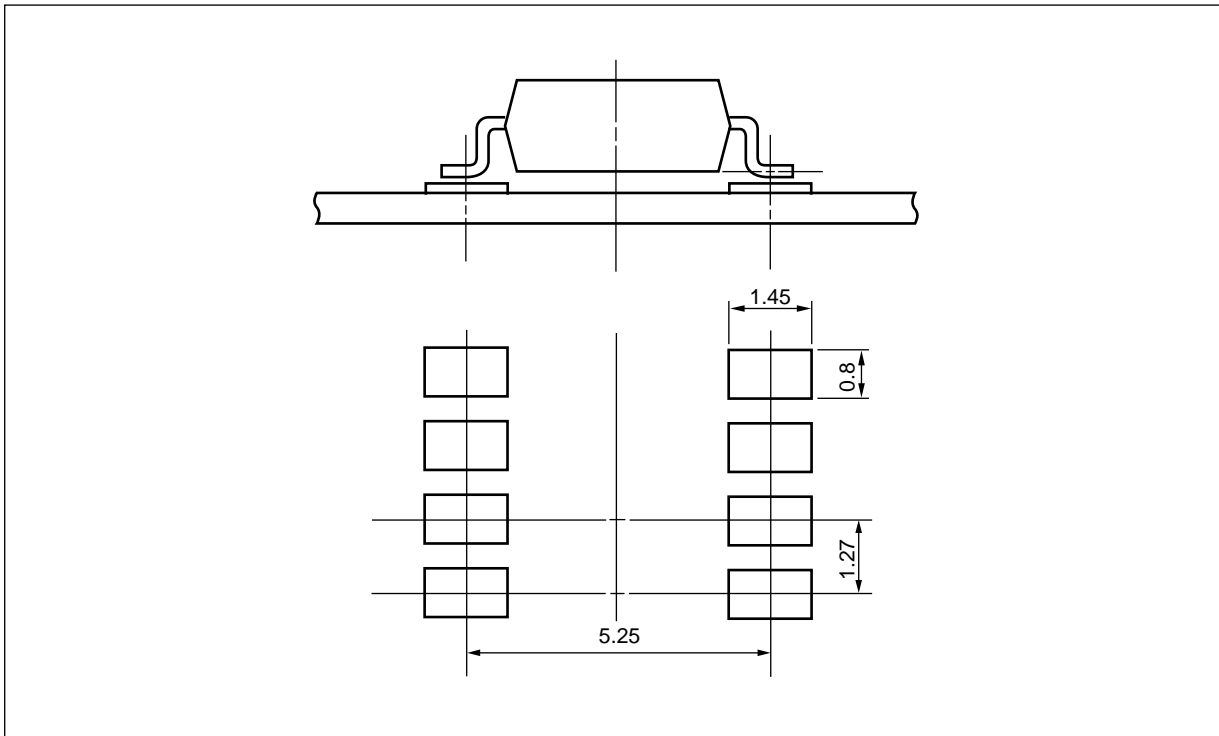

Remark All dimensions in this figure must be evaluated before use.

NOTES ON HANDLING

1. Recommended soldering conditions

(1) Infrared reflow soldering

- Peak reflow temperature 260 °C or below (package surface temperature)
- Time of peak reflow temperature 10 seconds or less
- Time of temperature higher than 220 °C 60 seconds or less
- Time to preheat temperature from 120 to 180 °C 120 ± 30 s
- Number of reflows Three
- Flux Rosin flux containing small amount of chlorine (The flux with a maximum chlorine content of 0.2 Wt% is recommended.)

Recommended Temperature Profile of Infrared Reflow

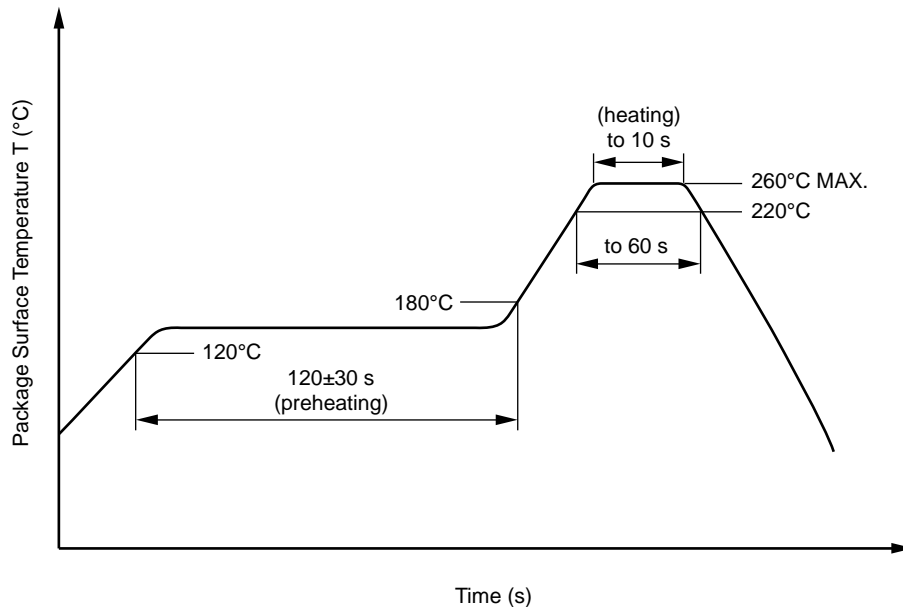

(2) Wave soldering

- Temperature 260 °C or below (molten solder temperature)
- Time 10 seconds or less
- Preheating conditions 120 °C or below (package surface temperature)
- Number of times One (Allowed to be dipped in solder including plastic mold portion.)
- Flux Rosin flux containing small amount of chlorine (The flux with a maximum chlorine content of 0.2 Wt% is recommended.)

(3) Soldering by Soldering Iron

- Peak Temperature (lead part temperature) 350 °C or below
- Time (each pins) 3 seconds or less
- Flux Rosin flux containing small amount of chlorine (The flux with a maximum chlorine content of 0.2 Wt% is recommended.)

(a) Soldering of leads should be made at the point 1.5 to 2.0 mm from the root of the lead

(b) Please be sure that the temperature of the package would not be heated over 100 °C

(4) Cautions

- Flux Cleaning
 - Avoid cleaning with Freon based or halogen-based (chlorinated etc.) solvents.
- Do not use fixing agents or coatings containing halogen-based substances.

2. Cautions regarding noise

Be aware that when voltage is applied suddenly between the photocoupler's input and output or between collector-emitters at startup, the output transistor may enter the on state, even if the voltage is within the absolute maximum ratings.

SPECIFICATION OF VDE MARKS LICENSE DOCUMENT

Parameter	Symbol	Rating	Unit
Climatic test class (IEC 60068-1/DIN EN 60068-1)		55/100/21	
Dielectric strength maximum operating isolation voltage	U_{IORM}	566	V_{peak}
Test voltage (partial discharge test, procedure a for type test and random test) $U_{pr} = 1.6 \times U_{IORM}, P_d < 5 \text{ pC}$	U_{pr}	849	V_{peak}
Test voltage (partial discharge test, procedure b for all devices) $U_{pr} = 1.875 \times U_{IORM}, P_d < 5 \text{ pC}$	U_{pr}	1 061	V_{peak}
Highest permissible overvoltage	U_{IOTM}	4 000	V_{peak}
Degree of pollution (IEC 60664-1/DIN EN 60664-1 (VDE 0110-1))		2	
Comparative tracking index (IEC 60112/DIN EN 60112 (VDE 0303-11))	CTI	175	
Material group (IEC 60664-1/DIN EN 60664-1 (VDE 0110-1))		III a	
Storage temperature range	T_{stg}	- 55 to +125	°C
Operating temperature range	T_A	- 40 to +85	°C
Isolation resistance, minimum value $V_{IO} = 500 \text{ V dc at } T_A = 25 \text{ °C}$ $V_{IO} = 500 \text{ V dc at } T_A \text{ MAX. at least } 100 \text{ °C}$	Ris MIN. Ris MIN.	10^{12} 10^{11}	Ω Ω
Safety maximum ratings (maximum permissible in case of fault, see thermal derating curve) Package temperature Current (input current I_F , $P_{si} = 0$) Power (output or total power dissipation) Isolation resistance $V_{IO} = 500 \text{ V dc at } T_A = T_{si}$	T_{si} I_{si} P_{si} Ris MIN.	150 150 600 10^9	°C mA mW Ω

Dependence of maximum safety ratings with package temperature

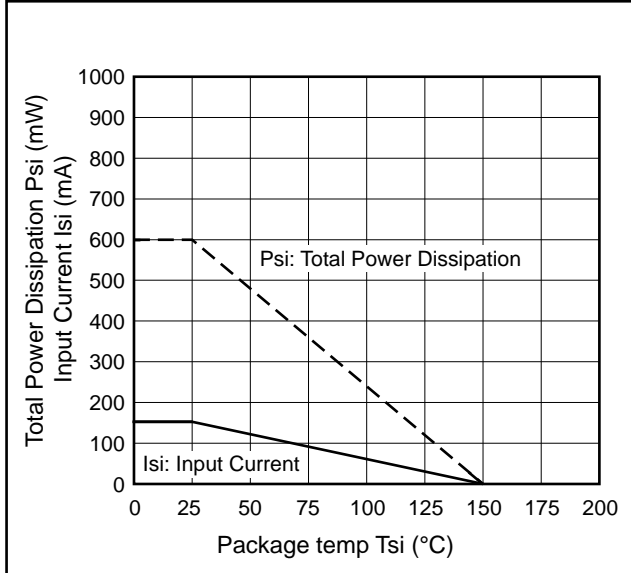

Method a) Destructive Test, Type and Sample Test

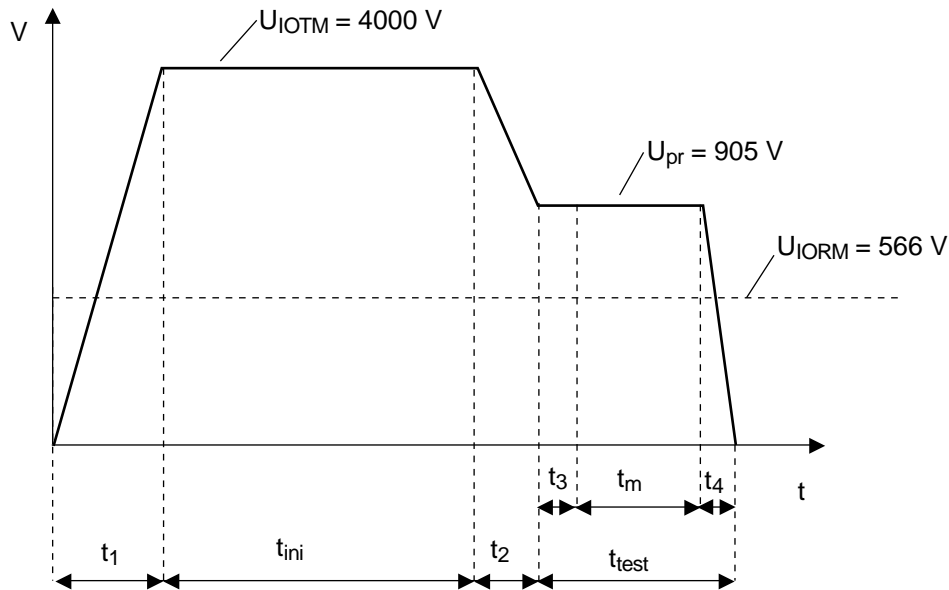

$t_1, t_2 = 1\text{ to }10\text{ sec}$
 $t_3, t_4 = 1\text{ sec}$
 $t_m(\text{PARTIAL DISCHARGE}) = 10\text{ sec}$
 $t_{test} = 12\text{ sec}$
 $t_{ini} = 60\text{ sec}$

Method b) Non-destructive Test, 100% Production Test

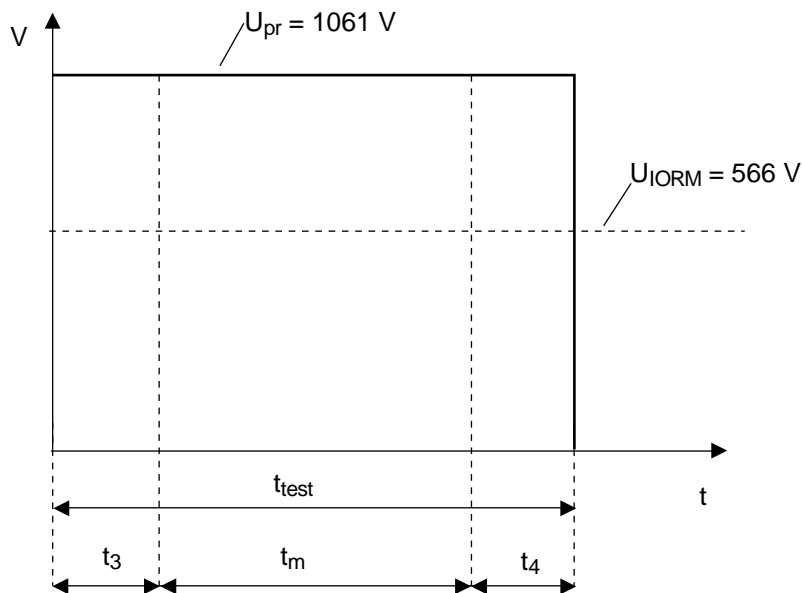

$t_3, t_4 = 0.1\text{ sec}$
 $t_m(\text{PARTIAL DISCHARGE}) = 1.0\text{ sec}$
 $t_{test} = 1.2\text{ sec}$

Caution	GaAs Products	<p>This product uses gallium arsenide (GaAs). GaAs vapor and powder are hazardous to human health if inhaled or ingested, so please observe the following points.</p> <ul style="list-style-type: none">• Follow related laws and ordinances when disposing of the product. If there are no applicable laws and/or ordinances, dispose of the product as recommended below.<ol style="list-style-type: none">1. Commission a disposal company able to (with a license to) collect, transport and dispose of materials that contain arsenic and other such industrial waste materials.2. Exclude the product from general industrial waste and household garbage, and ensure that the product is controlled (as industrial waste subject to special control) up until final disposal.• Do not burn, destroy, cut, crush, or chemically dissolve the product.• Do not lick the product or in any way allow it to enter the mouth.
----------------	---------------	--

All trademarks and registered trademarks are the property of their respective owners.

Notice

1. Descriptions of circuits, software and other related information in this document are provided only to illustrate the operation of semiconductor products and application examples. You are fully responsible for the incorporation or any other use of the circuits, software, and information in the design of your product or system. Renesas Electronics disclaims any and all liability for any losses and damages incurred by you or third parties arising from the use of these circuits, software, or information.
2. Renesas Electronics hereby expressly disclaims any warranties against and liability for infringement or any other claims involving patents, copyrights, or other intellectual property rights of third parties, by or arising from the use of Renesas Electronics products or technical information described in this document, including but not limited to, the product data, drawings, charts, programs, algorithms, and application examples.
3. No license, express, implied or otherwise, is granted hereby under any patents, copyrights or other intellectual property rights of Renesas Electronics or others.
4. You shall be responsible for determining what licenses are required from any third parties, and obtaining such licenses for the lawful import, export, manufacture, sales, utilization, distribution or other disposal of any products incorporating Renesas Electronics products, if required.
5. You shall not alter, modify, copy, or reverse engineer any Renesas Electronics product, whether in whole or in part. Renesas Electronics disclaims any and all liability for any losses or damages incurred by you or third parties arising from such alteration, modification, copying or reverse engineering.
6. Renesas Electronics products are classified according to the following two quality grades: "Standard" and "High Quality". The intended applications for each Renesas Electronics product depends on the product's quality grade, as indicated below.
 - "Standard": Computers; office equipment; communications equipment; test and measurement equipment; audio and visual equipment; home electronic appliances; machine tools; personal electronic equipment; industrial robots; etc.
 - "High Quality": Transportation equipment (automobiles, trains, ships, etc.); traffic control (traffic lights); large-scale communication equipment; key financial terminal systems; safety control equipment; etc.Unless expressly designated as a high reliability product or a product for harsh environments in a Renesas Electronics data sheet or other Renesas Electronics document, Renesas Electronics products are not intended or authorized for use in products or systems that may pose a direct threat to human life or bodily injury (artificial life support devices or systems; surgical implantations; etc.), or may cause serious property damage (space system; undersea repeaters; nuclear power control systems; aircraft control systems; key plant systems; military equipment; etc.). Renesas Electronics disclaims any and all liability for any damages or losses incurred by you or any third parties arising from the use of any Renesas Electronics product that is inconsistent with any Renesas Electronics data sheet, user's manual or other Renesas Electronics document.
7. No semiconductor product is absolutely secure. Notwithstanding any security measures or features that may be implemented in Renesas Electronics hardware or software products, Renesas Electronics shall have absolutely no liability arising out of any vulnerability or security breach, including but not limited to any unauthorized access to or use of a Renesas Electronics product or a system that uses a Renesas Electronics product. RENESAS ELECTRONICS DOES NOT WARRANT OR GUARANTEE THAT RENESAS ELECTRONICS PRODUCTS, OR ANY SYSTEMS CREATED USING RENESAS ELECTRONICS PRODUCTS WILL BE INVULNERABLE OR FREE FROM CORRUPTION, ATTACK, VIRUSES, INTERFERENCE, HACKING, DATA LOSS OR THEFT, OR OTHER SECURITY INTRUSION ("Vulnerability Issues"). RENESAS ELECTRONICS DISCLAIMS ANY AND ALL RESPONSIBILITY OR LIABILITY ARISING FROM OR RELATED TO ANY VULNERABILITY ISSUES. FURTHERMORE, TO THE EXTENT PERMITTED BY APPLICABLE LAW, RENESAS ELECTRONICS DISCLAIMS ANY AND ALL WARRANTIES, EXPRESS OR IMPLIED, WITH RESPECT TO THIS DOCUMENT AND ANY RELATED OR ACCOMPANYING SOFTWARE OR HARDWARE, INCLUDING BUT NOT LIMITED TO THE IMPLIED WARRANTIES OF MERCHANTABILITY, OR FITNESS FOR A PARTICULAR PURPOSE.
8. When using Renesas Electronics products, refer to the latest product information (data sheets, user's manuals, application notes, "General Notes for Handling and Using Semiconductor Devices" in the reliability handbook, etc.), and ensure that usage conditions are within the ranges specified by Renesas Electronics with respect to maximum ratings, operating power supply voltage range, heat dissipation characteristics, installation, etc. Renesas Electronics disclaims any and all liability for any malfunctions, failure or accident arising out of the use of Renesas Electronics products outside of such specified ranges.
9. Although Renesas Electronics endeavors to improve the quality and reliability of Renesas Electronics products, semiconductor products have specific characteristics, such as the occurrence of failure at a certain rate and malfunctions under certain use conditions. Unless designated as a high reliability product or a product for harsh environments in a Renesas Electronics data sheet or other Renesas Electronics document, Renesas Electronics products are not subject to radiation resistance design. You are responsible for implementing safety measures to guard against the possibility of bodily injury, injury or damage caused by fire, and/or danger to the public in the event of a failure or malfunction of Renesas Electronics products, such as safety design for hardware and software, including but not limited to redundancy, fire control and malfunction prevention, appropriate treatment for aging degradation or any other appropriate measures. Because the evaluation of microcomputer software alone is very difficult and impractical, you are responsible for evaluating the safety of the final products or systems manufactured by you.
10. Please contact a Renesas Electronics sales office for details as to environmental matters such as the environmental compatibility of each Renesas Electronics product. You are responsible for carefully and sufficiently investigating applicable laws and regulations that regulate the inclusion or use of controlled substances, including without limitation, the EU RoHS Directive, and using Renesas Electronics products in compliance with all these applicable laws and regulations. Renesas Electronics disclaims any and all liability for damages or losses occurring as a result of your noncompliance with applicable laws and regulations.
11. Renesas Electronics products and technologies shall not be used for or incorporated into any products or systems whose manufacture, use, or sale is prohibited under any applicable domestic or foreign laws or regulations. You shall comply with any applicable export control laws and regulations promulgated and administered by the governments of any countries asserting jurisdiction over the parties or transactions.
12. It is the responsibility of the buyer or distributor of Renesas Electronics products, or any other party who distributes, disposes of, or otherwise sells or transfers the product to a third party, to notify such third party in advance of the contents and conditions set forth in this document.
13. This document shall not be reprinted, reproduced or duplicated in any form, in whole or in part, without prior written consent of Renesas Electronics.
14. Please contact a Renesas Electronics sales office if you have any questions regarding the information contained in this document or Renesas Electronics products.

(Note1) "Renesas Electronics" as used in this document means Renesas Electronics Corporation and also includes its directly or indirectly controlled subsidiaries.

(Note2) "Renesas Electronics product(s)" means any product developed or manufactured by or for Renesas Electronics.

(Rev.5.0-1 October 2020)

Corporate Headquarters

TOYOSU FORESIA, 3-2-24 Toyosu,
Koto-ku, Tokyo 135-0061, Japan
www.renesas.com

Trademarks



Renesas and the Renesas logo are trademarks of Renesas Electronics Corporation. All trademarks and registered trademarks are the property of their respective owners.

Contact information

For further information on a product, technology, the most up-to-date version of a document, or your nearest sales office, please visit:
www.renesas.com/contact/.

Looking for pricing, stock, or lifecycle information?

Click below to explore more details on WIN SOURCE:

-  [View PS9821-1-V-F3-AX on WIN SOURCE](#)
-  [Renesas Electronics America Information](#)

Optimize Your Supply Chain with WIN SOURCE Solutions

-  Global Sourcing Solution
-  Obsolete Management
-  Cost Control Management
-  Shortage Management
-  Alternative Solution
-  Excess Inventory Management