



**THE DATASHEET OF  
PI6ULS5V9515AZEEX**



## Features

- 2 channel, bidirectional buffer
  - I<sup>2</sup>C-bus and SMBus compatible
  - Operating supply voltage range of 2.3 V to 3.6 V
  - Active HIGH repeater enable input
  - Open-drain input/outputs
  - Lock-up free operation
  - Supports arbitration and clock stretching across the repeater
  - Accommodates Standard-mode and Fast-mode I<sup>2</sup>C-bus devices and multiple masters
  - Powered-off high-impedance I<sup>2</sup>C-bus pins
  - 5.5 V tolerant I<sup>2</sup>C-bus and enable pins
  - 0 Hz to 400 kHz clock frequency (the maximum system operating frequency may be less than 400 kHz because of the delays added by the repeater)
  - ESD protection exceeds 4KV HBM per JESD22-A114
  - Totally Lead-Free & Fully RoHS Compliant (Notes 1 & 2)
  - Halogen and Antimony Free. "Green" Device (Note 3)
  - For automotive applications requiring specific change control (i.e. parts qualified to AEC-Q100/101/200, PPAP capable, and manufactured in IATF 16949 certified facilities), please [contact us](mailto:contact_us@diodes.com) or your local Diodes representative.
- <https://www.diodes.com/quality/product-definitions/>
- Package: MSOP-8, SOIC-8 and DFN2x3-8L

## Description

The PI6ULS5V9515A is a CMOS integrated circuit intended for I<sup>2</sup>C bus and SMBus systems applications. The device contains two identical bidirectional open-drain buffer circuits that enable I<sup>2</sup>C and similar bus systems to be extended without degradation of system performance.

The PI6ULS5V9515A enables the system designer to isolate two halves of a bus for both voltage and capacitance, accommodating more I<sup>2</sup>C devices or longer trace length. It also permits extension of the I<sup>2</sup>C-bus by providing bidirectional buffering for both the data (SDA) and the clock (SCL) lines, thus allowing two buses of 400 pF to be connected in an I<sup>2</sup>C application.

The PI6ULS5V9515A has an EN pin to turn the drivers on and off. This can be used to isolate a badly behaved slave on power-up until after the system power-up reset. It should never change state during an I<sup>2</sup>C-bus operation because disabling during a bus operation will hang the bus and enabling part way through a bus cycle could confuse the I<sup>2</sup>C-bus parts being enabled. The enable pin should only change state when the global bus and the repeater port are in an idle state to prevent system failures.

The output low levels for sides are approximately 0.5 V, but the input voltage of each internal buffer must be 70 mV lower (0.43V) or even more lower. When the output internally is driven low the low is not recognized as a low by the input. This prevents a lockup condition from occurring when the input low condition is released.

Two or more PI6ULS5V9515A devices can't be used in series. The PI6ULS5V9515A design does not allow this configuration. Since there is no direction pin, slightly different valid low-voltage levels are used to avoid lockup conditions between the input and the output of each repeater. A valid low applied at the input of a PI6ULS5V9515A will be propagated as a buffered low with a slightly higher value on the output. When this buffered low is applied to another PI6ULS5V9515A-type device in series, the second device does not recognize it as a valid low and will not propagate it as a buffered low again.

The device contains a power-up control circuit that sets an internal latch to prevent the output circuits from becoming active until V<sub>CC</sub> is at a valid level (V<sub>CC</sub> = 2.3 V).

As with the standard I<sup>2</sup>C system, pull-up resistors are required to provide the logic-high levels on the buffered bus. The PI6ULS5V9515A has standard open-collector configuration of the I<sup>2</sup>C bus. The size of these pull-up resistors depends on the system, but each side of the repeater must have a pull-up resistor. The device is designed to work with Standard mode and Fast mode I<sup>2</sup>C devices in addition to SMBus devices. Standard mode I<sup>2</sup>C devices only specify 3mA in a generic I<sup>2</sup>C system, where Standard mode devices and multiple masters are possible. Under certain conditions, higher termination currents can be used.

### Notes:

1. No purposely added lead. Fully EU Directive 2002/95/EC (RoHS), 2011/65/EU (RoHS 2) & 2015/863/EU (RoHS 3) compliant.
2. See <https://www.diodes.com/quality/lead-free/> for more information about Diodes Incorporated's definitions of Halogen- and Antimony-free, "Green" and Lead-free.
3. Halogen- and Antimony-free "Green" products are defined as those which contain <900ppm bromine, <900ppm chlorine (<1500ppm total Br + Cl) and <1000ppm antimony compounds.

## Pin Configuration

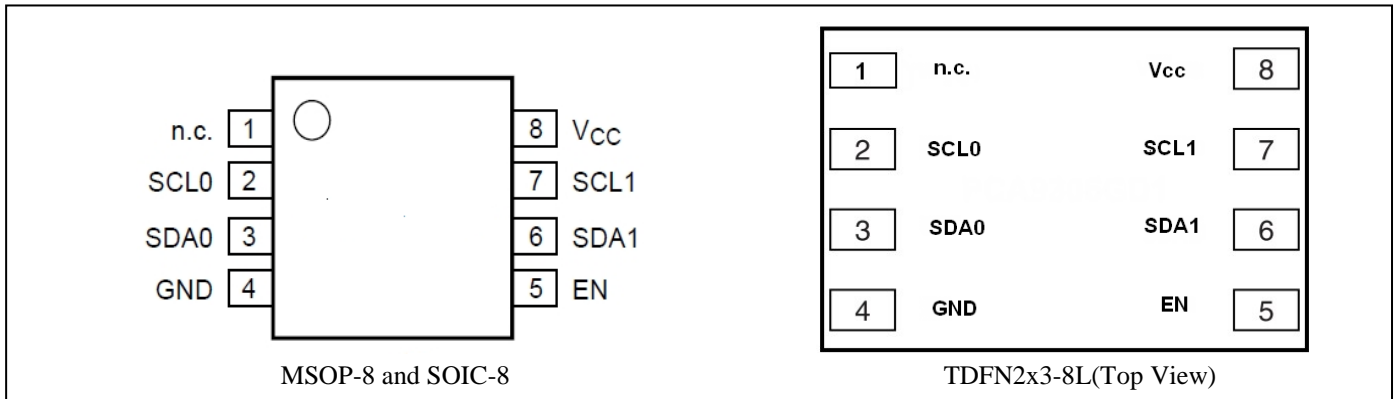

## Pin Description

Pin#	Name	Description
1	n.c.	Not connected
2	SCL0	serial clock port 0 bus
3	SDA0	serial data port 0 bus
4	GND	supply ground (0 V)
5	EN	active HIGH repeater enable input
6	SDA1	serial data port 1 bus
7	SCL1	serial clock port 1 bus
8	V <sub>CC</sub>	supply voltage (2.3 V to 3.6 V)

## Block Diagram

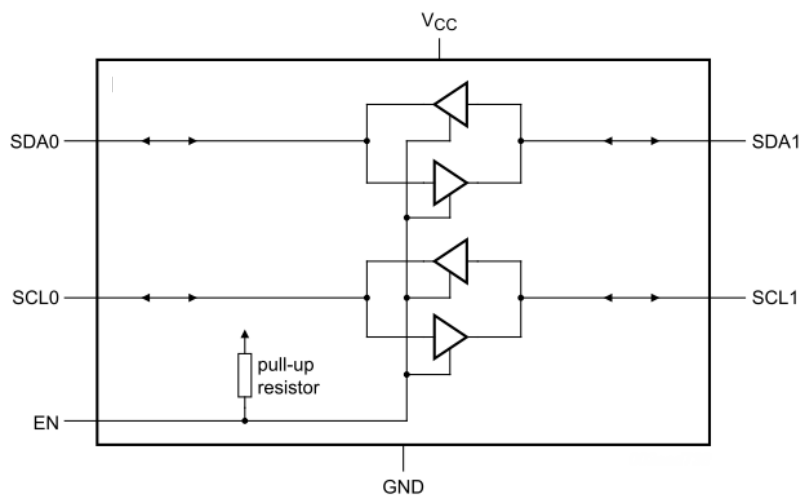

Figure 1: Block Diagram

EN	Function
H	SCL0 = SCL1; SDA0 = SDA1;
L	disabled

## Maximum Ratings

Storage Temperature.....	-55°C to +125°C
DC Input Voltage.....	-0.5V to +6.0V
Control Input Voltage(EN).....	-0.5V to +6.0V
Total Power Dissipation.....	100mA
Input/Output Current (portA&B).....	50mA
Input Current (EN, V <sub>CC(A)</sub> , V <sub>CC(B)</sub> , GND).....	50mA
ESD: HBM Mode.....	4000V

### Note:

Stresses greater than those listed under MAXIMUM RATINGS may cause permanent damage to the device. This is a stress rating only and functional operation of the device at these or any other conditions above those indicated in the operational sections of this specification is not implied. Exposure to absolute maximum rating conditions for extended periods may affect reliability.

## Recommended Operation Conditions

V<sub>CC</sub> = 2.3 V to 3.6 V; GND = 0 V; T<sub>amb</sub> = -40 °C to +85 °C; unless otherwise specified

Symbol	Parameter	Test Conditions	Min.	Typ.	Max.	Unit
V <sub>CC</sub>	supply voltage port	-	2.3	-	3.6	V
I <sub>CCH</sub>	HIGH-level supply current	both channels HIGH;; SDAn = SCLn = V <sub>CC</sub> V <sub>CC</sub> = 2.7 V	-	0.5	5	mA
		both channels HIGH;; SDAn = SCLn = V <sub>CC</sub> V <sub>CC</sub> = 3.6 V	-	0.5	5	mA
I <sub>CCL</sub>	LOW-level supply current	both channels LOW; V <sub>CC</sub> = 2.7 V; one SDA and one SCL = GND; other SDA and SCL open	-	1.6	5	mA
		both channels LOW; V <sub>CC</sub> = 3.6 V; one SDA and one SCL = GND; other SDA and SCL open	-	1.7	5	mA
I <sub>CCLC</sub>	contention port A supply current	V <sub>CC</sub> = 2.7V or 3.6V; SDAn = SCLn = GND	-	1.6	5	mA

## DC Electrical Characteristics

V<sub>CC</sub> = 2.7 V to 5.5 V; GND = 0 V; T<sub>amb</sub> = -40 °C to +85 °C; unless otherwise specified

Parameter	Description	Test Conditions <sup>(1)</sup>	Min.	Typ. <sup>(2)</sup>	Max.	Unit
<b>Input and output SDAn and SCLn</b>						
V <sub>IH</sub>	HIGH-level input voltage	-	0.7V <sub>CC</sub>	-	5.5	V
V <sub>IL</sub> <sup>(1)</sup>	LOW-level input voltage	-	-0.5	-	+0.3V <sub>CC</sub>	
V <sub>ILc</sub>	Contention LOW-level input voltage	-	-0.5	0.4	-	
V <sub>IK</sub>	Input clamping voltage	I <sub>I</sub> = -18 mA	-	-	-1.2	V
I <sub>LI</sub>	Input leakage current	V <sub>I</sub> = 3.6 V	-	-	±1	µA
I <sub>IL</sub>	LOW-level input current	V <sub>CC</sub> =2.3-2.7 V ; SDA, SCL; V <sub>I</sub> = 0.2 V	-	-	10	µA
		V <sub>CC</sub> =3.0-3.6 V ; SDA, SCL; V <sub>I</sub> = 0.2 V	-	-	5	µA
V <sub>OL</sub>	LOW-level output voltage	I <sub>OL</sub> = 20 µA or 6 mA	0.47	0.52	0.6	V
V <sub>OL</sub> -V <sub>ILc</sub>	Difference between LOW-level output and LOW-level input voltage contention	guaranteed by design	-	70	-	mV
I <sub>LOH</sub>	HIGH-level output leakage current	V <sub>O</sub> = 3.6 V	-	-	10	µA
C <sub>io</sub>	input/output capacitance	V <sub>I</sub> = 3 V or 0 V	-	6	-	pF
<b>Enable</b>						
V <sub>IH</sub>	HIGH-level input voltage	-	2.0	-	5.5	V
V <sub>IL</sub>	LOW-level input voltage	-	-0.5	-	+0.8	V
I <sub>IL</sub>	LOW-level input current	V <sub>I</sub> = 0.2 V	-	-10	-30	µA
I <sub>LI</sub>	Input leakage current	V <sub>I</sub> = V <sub>CC</sub>	-1	-	+1	µA
C <sub>i</sub>	Input capacitance	V <sub>I</sub> = 3.0 V or 0 V	-	6	-	pF

### Notes:

1 V<sub>IL</sub> specification is for the first LOW level seen by the SDAB/SCLB lines. V<sub>ILc</sub> is for the second and subsequent LOW levels seen by the SDAn/SCLn lines.

**Dynamic Characteristics**

GND = 0 V; T<sub>amb</sub> = -40 °C to +85 °C; unless otherwise specified. <sup>(1)(2)</sup>

Symbol	Parameter	Test Conditions	Min.	Typ.	Max.	Unit
V <sub>cc</sub> =2.3-2.7V						
t <sub>PLH</sub>	LOW-to-HIGH propagation delay	-	33	113	190	ns
t <sub>PHL</sub>	HIGH-to-LOW propagation delay	-	-	82	130	ns
t <sub>TLH</sub>	LOW-to-HIGH transition time	-	-	148	-	ns
t <sub>THL</sub>	HIGH-to-LOW transition time	-	-	57	-	ns
t <sub>SU</sub>	Set-up time	-	100	-	-	ns
t <sub>H</sub>	Hold time	-	130	-	-	ns
V <sub>cc</sub> =3.0-3.6V						
t <sub>PLH</sub>	LOW-to-HIGH propagation delay	-	33	102	180	ns
t <sub>PHL</sub>	HIGH-to-LOW propagation delay	-	-	68	120	ns
t <sub>TLH</sub>	LOW-to-HIGH transition time	-	-	147	-	ns
t <sub>THL</sub>	HIGH-to-LOW transition time	-	-	58	-	ns
t <sub>SU</sub>	Set-up time	-	100	-	-	ns
t <sub>H</sub>	Hold time	-	100	-	-	ns

Notes:

(1) Typical values taken at V<sub>CC</sub> = 3.3 V and T<sub>amb</sub> = 25°C.

(2) Different load resistance and capacitance will alter the RC time constant, thereby changing the propagation delay and transition times.

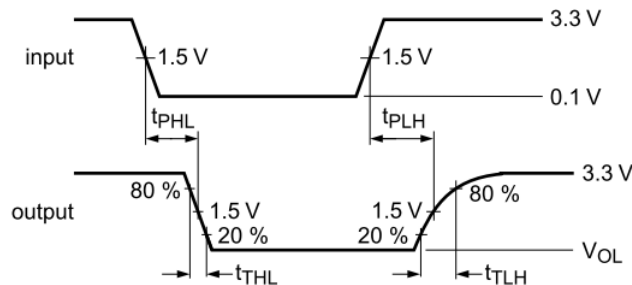
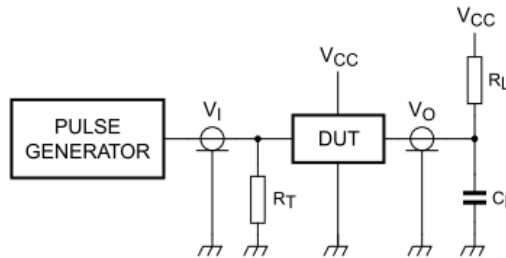

Figure 2: Propagation Delay and Transition Times



R<sub>L</sub> = load resistor; 1.35 kΩ

C<sub>L</sub> = load capacitance includes jig and probe capacitance; 50 pF

R<sub>T</sub> = termination resistance should be equal to Z<sub>o</sub> of pulse generators

Figure 3: Test Circuit

## Functional Description

The PI6ULS5V9515A is a CMOS integrated circuit intended for I<sup>2</sup>C bus and SMBus systems applications. The device contains two identical bidirectional open-drain buffer circuits that enable I<sup>2</sup>C and similar bus systems to be extended without degradation of system performance.

The PI6ULS5V9515A enables the system designer to isolate two halves of a bus for both voltage and capacitance, accommodating more I<sup>2</sup>C devices or longer trace length. It also permits extension of the I<sup>2</sup>C-bus by providing bidirectional buffering for both the data (SDA) and the clock (SCL) lines, thus allowing two buses of 400 pF to be connected in an I<sup>2</sup>C application.

The PI6ULS5V9515A has an EN pin to turn the drivers on and off. This can be used to isolate a badly behaved slave on power-up until after the system power-up reset. It should never change state during an I<sup>2</sup>C-bus operation because disabling during a bus operation will hang the bus and enabling part way through a bus cycle could confuse the I<sup>2</sup>C-bus parts being enabled. The enable pin should only change state when the global bus and the repeater port are in an idle state to prevent system failures.

The output low levels for sides are approximately 0.5 V, but the input voltage of each internal buffer must be 70 mV lower (0.43V) or even more lower. When the output internally is driven low the low is not recognized as a low by the input. This prevents a lockup condition from occurring when the input low condition is released.

Two or more PI6ULS5V9515A devices can't be used in series. The PI6ULS5V9515A design does not allow this configuration. Since there is no direction pin, slightly different valid low-voltage levels are used to avoid lockup conditions between the input and the output of each repeater. A valid low applied at the input of a PI6ULS5V9515A will be propagated as a buffered low with a slightly higher value on the output. When this buffered low is applied to another PI6ULS5V9515A-type device in series, the second device does not recognize it as a valid low and will not propagate it as a buffered low again.

The device contains a power-up control circuit that sets an internal latch to prevent the output circuits from becoming active until V<sub>CC</sub> is at a valid level (V<sub>CC</sub> = 2.3 V).

As with the standard I<sup>2</sup>C system, pull-up resistors are required to provide the logic-high levels on the buffered bus. The PI6ULS5V9515A has standard open-collector configuration of the I<sup>2</sup>C bus. The size of these pull-up resistors depends on the system, but each side of the repeater must have a pull-up resistor. The device is designed to work with Standard mode and Fast mode I<sup>2</sup>C devices in addition to SMBus devices. Standard mode I<sup>2</sup>C devices only specify 3 mA in a generic I<sup>2</sup>C system, where Standard mode devices and multiple masters are possible. Under certain conditions, higher termination currents can be used.

## Application Information

A typical application is shown in Figure 4. In this example, the system master is running on a 3.3 V I<sup>2</sup>C-bus while the slave is connected to a 5V bus. Both buses run at 400 kHz. Master devices can be placed on either bus.

The PI6ULS5V9515A is 5V tolerant, so it does not require any additional circuitry to translate between different bus voltages. When one side of the PI6ULS5V9515A is pulled LOW by a device on the I<sup>2</sup>C-bus, a CMOS hysteresis type input detects the falling edge and causes the internal driver on the other side to turn on, thus causing the other side to also go LOW. The side driven LOW by the PI6ULS5V9515A will typically be at V<sub>OL</sub> = 0.5 V.

Figure 5 and Figure 6 show the waveforms that are seen in a typical application. If the bus master in Figure 4 writes to the slave through the PI6ULS5V9515A, Bus 0 has the waveform shown in Figure 5. This looks like a normal I<sup>2</sup>C transmission until the falling edge of the eighth clock pulse. At that point, the master releases the data line (SDA) while the slave pulls it low through the PI6ULS5V9515A. Because the V<sub>OL</sub> of the PI6ULS5V9515A typically is around 0.5V, a step in the SDA is seen. After the master has transmitted the ninth clock pulse, the slave releases the data line.

On the Bus 1 side of the PI6ULS5V9515A, the clock and data lines have a positive offset from ground equal to the V<sub>OL</sub> of the PI6ULS5V9515A. After the eighth clock pulse, the data line is pulled to the V<sub>OL</sub> of the slave device, which is very close to ground in the example.

It is important to note that any arbitration or clock-stretching events on Bus 1 require that the V<sub>OL</sub> of the devices on Bus 1 be 70 mV below the V<sub>OL</sub> of the PI6ULS5V9515A (see V<sub>OL</sub> - V<sub>ILC</sub> in Electrical Characteristics) to be recognized by the PI6ULS5V9515A and transmitted to Bus 0.

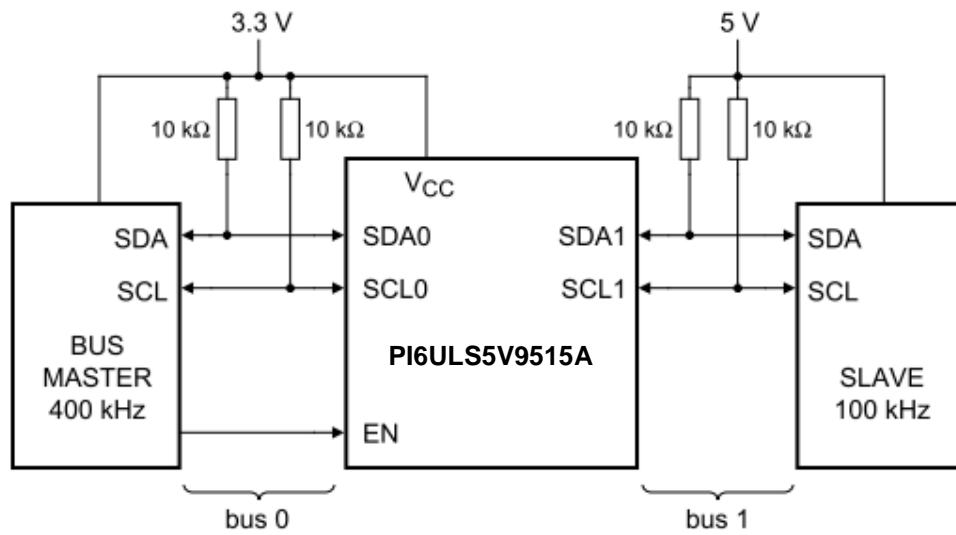

Figure 4: Typical Application

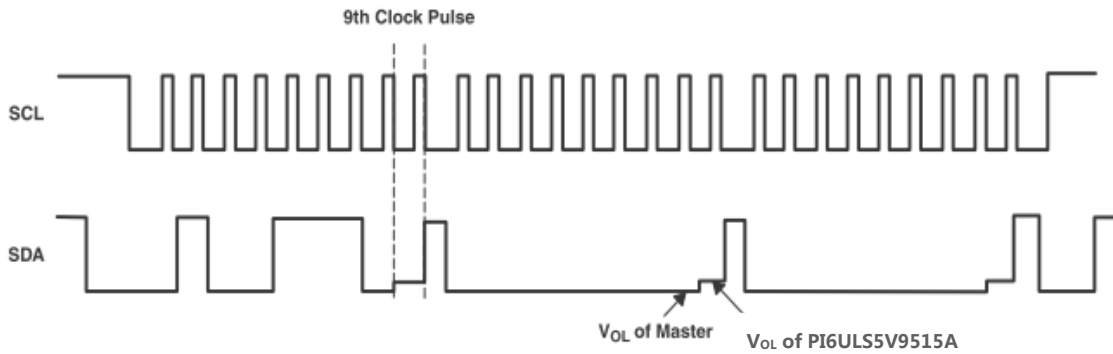

Figure 5: Bus 0 Waveforms

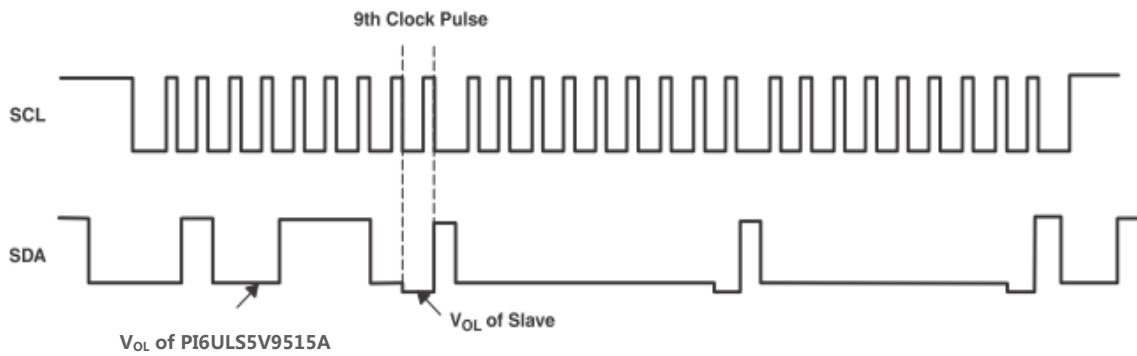

Figure 6: Bus 1 Waveforms

## Part Marking

### U Package



1st Y: Die Rev

2nd Y: Year

W: Workweek

1st X: Assembly Site Code

2nd X: Fab Site Code

Bar above "L" means Fab3 of MGN

Bar above Fab site code means Cu wire

### ZE Package

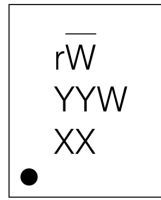

rW: PI6ULS5V9515AZEE

1st Y: Die Rev

2nd Y: Date Code (Year)

W: Date Code (Workweek)

1st X: Assembly Site Code

2nd X: Fab Site Code

Bar above "W" means Fab3 of MGN

**Packaging Mechanical**  
MSOP-8 (U)

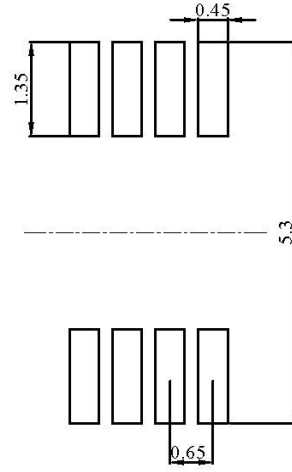
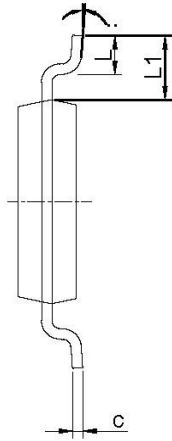
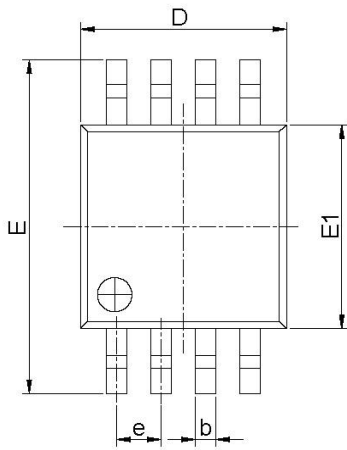

PKG DIMENSIONS(MM)		
SYMBOL	Min.	Max.
A	-	1.10
A1	0.00	0.15
A2	0.75	0.95
b	0.22	0.38
c	0.08	0.23
D	2.80	3.20
E	4.65	5.15
E1	2.80	3.20
e	0.65 BSC	
L	0.40	0.80
L1	0.95 REF	
θ	0°	8°

RECOMMENDED LAND PATTERN(unit:mm)

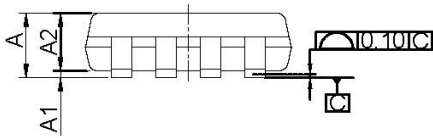

**NOTE:**

1. ALL DIMENSIONS ARE IN MILLIMETERS. ANGLES IN DEGREES.
2. REFER JEDEC MO-187F/AA
3. PACKAGE OUTLINE DIMENSIONS DO NOT INCLUDE MOLD FLASH AND METAL BURR.
4. LAND PATTERN REFERENCE DIODES MSOP-8 PACKAGE INFORMATION.

		DATE: 11/04/19
DESCRIPTION: 8-Pin, Mini Small Outline Package, MSOP		
PACKAGE CODE: U (U8)		
DOCUMENT CONTROL #: PD-1261	REVISION: H	

19-1147

TDFN-8 (ZE)

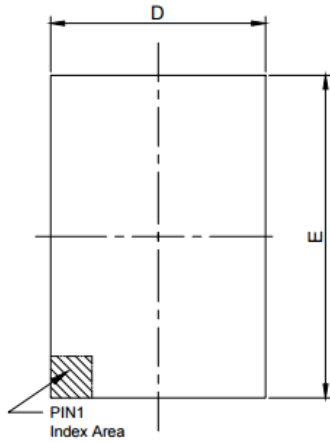

TOP VIEW

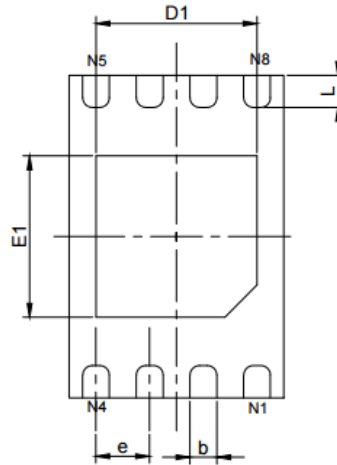

BOTTOM VIEW

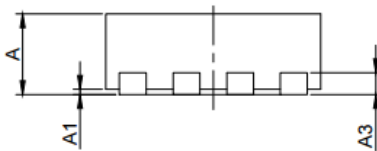

SIDE VIEW

PKG. DIMENSIONS(MM)		
SYMBOL	Min	Max
A	0.70	0.80
A1	0.00	0.05
A3	0.20 REF	
D	1.92	2.08
E	2.92	3.07
D1	1.40	1.60
E1	1.40	1.60
k	0.20 MIN	
b	0.20	0.30
e	0.50 TYP	
L	0.22	0.38

Notes:

1. Ref: JEDEC MO-229



DATE: 06/14/13

DESCRIPTION: 8-Pin, TDFN, 2X3

PACKAGE CODE: ZE (ZE8)

DOCUMENT CONTROL#: PD-2116

REVISION: --

**Recommended Land pattern for TDFN2\*3-8L**

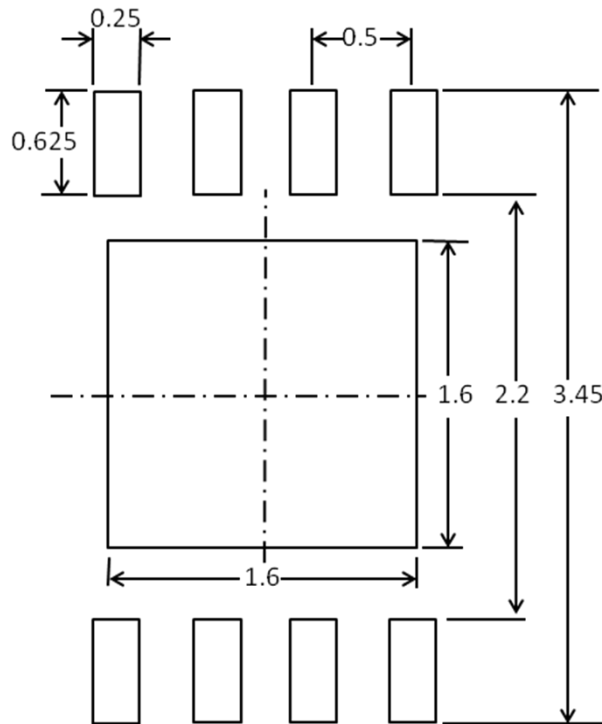

Note:  
All linear dimensions are in millimeters

For latest package info.

please check: <http://www.diodes.com/design/support/packaging/pericom-packaging/packaging-mechanicals-and-thermal-characteristics/>

**Ordering Information**

Part Numbers	Package Code	Package Description
PI6ULS5V9515AUEx	U	8-pin, Mini Small Outline Package (MSOP)
PI6ULS5V9515AZEx	ZE	8-pin, 2x3 (TDFN)

**Notes:**

1. No purposely added lead. Fully EU Directive 2002/95/EC (RoHS), 2011/65/EU (RoHS 2) & 2015/863/EU (RoHS 3) compliant.
2. See <https://www.diodes.com/quality/lead-free/> for more information about Diodes Incorporated's definitions of Halogen- and Antimony-free, "Green" and Lead-free.
3. Halogen- and Antimony-free "Green" products are defined as those which contain <900ppm bromine, <900ppm chlorine (<1500ppm total Br + Cl) and <1000ppm antimony compounds.
4. E = Pb-free and Green
5. X suffix = Tape/Reel

**IMPORTANT NOTICE**

DIODES INCORPORATED MAKES NO WARRANTY OF ANY KIND, EXPRESS OR IMPLIED, WITH REGARDS TO THIS DOCUMENT, INCLUDING, BUT NOT LIMITED TO, THE IMPLIED WARRANTIES OF MERCHANTABILITY AND FITNESS FOR A PARTICULAR PURPOSE (AND THEIR EQUIVALENTS UNDER THE LAWS OF ANY JURISDICTION).

Diodes Incorporated and its subsidiaries reserve the right to make modifications, enhancements, improvements, corrections or other changes without further notice to this document and any product described herein. Diodes Incorporated does not assume any liability arising out of the application or use of this document or any product described herein; neither does Diodes Incorporated convey any license under its patent or trademark rights, nor the rights of others. Any Customer or user of this document or products described herein in such applications shall assume all risks of such use and will agree to hold Diodes Incorporated and all the companies whose products are represented on Diodes Incorporated website, harmless against all damages.

Diodes Incorporated does not warrant or accept any liability whatsoever in respect of any products purchased through unauthorized sales channel.

Should Customers purchase or use Diodes Incorporated products for any unintended or unauthorized application, Customers shall indemnify and hold Diodes Incorporated and its representatives harmless against all claims, damages, expenses, and attorney fees arising out of, directly or indirectly, any claim of personal injury or death associated with such unintended or unauthorized application.

Products described herein may be covered by one or more United States, international or foreign patents pending. Product names and markings noted herein may also be covered by one or more United States, international or foreign trademarks.

This document is written in English but may be translated into multiple languages for reference. Only the English version of this document is the final and determinative format released by Diodes Incorporated.

**LIFE SUPPORT**

Diodes Incorporated products are specifically not authorized for use as critical components in life support devices or systems without the express written approval of the Chief Executive Officer of Diodes Incorporated. As used herein:

A. Life support devices or systems are devices or systems which:

1. are intended to implant into the body, or
2. support or sustain life and whose failure to perform when properly used in accordance with instructions for use provided in the labeling can be reasonably expected to result in significant injury to the user.



B. A critical component is any component in a life support device or system whose failure to perform can be reasonably expected to cause the failure of the life support device or to affect its safety or effectiveness.

Customers represent that they have all necessary expertise in the safety and regulatory ramifications of their life support devices or systems, and acknowledge and agree that they are solely responsible for all legal, regulatory and safety-related requirements concerning their products and any use of Diodes Incorporated products in such safety-critical, life support devices or systems, notwithstanding any devices- or systems-related information or support that may be provided by Diodes Incorporated. Further, Customers must fully indemnify Diodes Incorporated and its representatives against any damages arising out of the use of Diodes Incorporated products in such safety-critical, life support devices or systems.







Copyright © 2020, Diodes Incorporated  
[www.diodes.com](http://www.diodes.com)

## Looking for pricing, stock, or lifecycle information?

Click below to explore more details on WIN SOURCE:

-  [View PI6ULS5V9515AZEEX on WIN SOURCE](#)
-  [Diodes Incorporated Information](#)

## Optimize Your Supply Chain with WIN SOURCE Solutions

-  Global Sourcing Solution
-  Obsolete Management
-  Cost Control Management
-  Shortage Management
-  Alternative Solution
-  Excess Inventory Management