



THE DATASHEET OF PDZ18BGWJ





PDZ-GW series

Single Zener diodes in a SOD123 package

Rev. 1 — 4 September 2017

Product data sheet

1 Product profile

1.1 General description

General-purpose Zener diodes in a SOD123 small Surface-Mounted Device (SMD) plastic package.

1.2 Features and benefits

- Non-repetitive peak reverse power dissipation: $P_{ZSM} \leq 40 \text{ W}$
- Total power dissipation: $P_{tot} \leq 365 \text{ mW}$
- Tolerance series:
B2: approximately $\pm 2 \%$
- Wide working voltage range: nominal 2.4 V to 36 V (E24 range)
- Low reverse current I_R range
- Small plastic package suitable for surface-mounted design
- AEC-Q101 qualified

1.3 Applications

- General regulation functions

1.4 Quick reference data

Table 1. Quick reference data

Symbol	Parameter	Conditions	Min	Typ	Max	Unit
V_F	forward voltage	$I_F = 10 \text{ mA}$ [1]	-	-	0.9	V
P_{tot}	total power dissipation	$T_{amb} \leq 25 \text{ °C}$ [2]	-	-	365	mW
		[3]	-	-	625	mW

[1] Pulse test: $t_p \leq 300 \text{ }\mu\text{s}$; $\delta \leq 0.02$.

[2] Device mounted on an FR4 Printed-Circuit Board (PCB), single-sided copper, tin-plated and standard footprint.

[3] Device mounted on an FR4 PCB, single-sided copper, tin-plated, mounting pad for cathode 1 cm^2 .

2 Pinning information

Table 2. Pinning

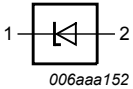
Pin	Symbol	Description	Simplified outline	Graphic symbol
1	K	cathode ^[1]		
2	A	anode		

[1] The marking bar indicates the cathode.

3 Ordering information

Table 3. Ordering information

Type number	Package		
	Name	Description	Version
PDZ2.4BGW to PDZ36BGW ^[1]	-	plastic surface-mounted package; 2 leads	SOD123

[1] The series consists of 29 types with nominal working voltages from 2.4 V to 36 V.

4 Marking

Table 4. Marking Codes

Type number	Marking Code	Type number	Marking Code	Type number	Marking Code
PDZ2.4BGW	B1	PDZ6.2BGW	BB	PDZ16BGW	BM
PDZ2.7BGW	B2	PDZ6.8BGW	BC	PDZ18BGW	BN
PDZ3.0BGW	B3	PDZ7.5BGW	BD	PDZ20BGW	BP
PDZ3.3BGW	B4	PDZ8.2BGW	BE	PDZ22BGW	BQ
PDZ3.6BGW	B5	PDZ9.1BGW	BF	PDZ24BGW	BR
PDZ3.9BGW	B6	PDZ10BGW	BG	PDZ27BGW	BS
PDZ4.3BGW	B7	PDZ11BGW	BH	PDZ30BGW	BT
PDZ4.7BGW	B8	PDZ12BGW	BJ	PDZ33BGW	BU
PDZ5.1BGW	B9	PDZ13BGW	BK	PDZ36BGW	BV
PDZ5.6BGW	BA	PDZ15BGW	BL		

5 Limiting values

Table 5. Limiting values

In accordance with the Absolute Maximum Rating System (IEC 60134).

Symbol	Parameter	Conditions	Min	Max	Unit
I_F	forward current		-	200	mA
I_{ZSM}	non-repetitive peak reverse current		-	see characteristics table	
P_{ZSM}	non-repetitive peak power dissipation		[1] -	40	W
P_{tot}	total power dissipation	$T_{amb} \leq 25\text{ °C}$	[2] -	365	mW
			[3] -	625	mW
T_j	junction temperature		-	150	
T_{amb}	ambient temperature		-55	+150	°C
T_{stg}	storage temperature		-65	+150	°C

[1] $t_p = 100\text{ }\mu\text{s}$; square wave; $T_j = 25\text{ °C}$ prior to surge.

[2] Device mounted on an FR4 PCB, single-sided copper, tin-plated and standard footprint.

[3] Device mounted on an FR4 PCB, single-sided copper, tin-plated, mounting pad for cathode 1 cm^2 .

6 Thermal characteristics

Table 6. Thermal characteristics

Symbol	Parameter	Conditions	Min	Typ	Max	Unit
$R_{th(j-a)}$	thermal resistance from junction to ambient	in free air	[1] -	-	340	K/W
			[2] -	-	200	K/W
$R_{th(j-sp)}$	thermal resistance from junction to solder point	[3] -	-	-	50	K/W

[1] Device mounted on an FR4 Printed-Circuit Board (PCB), single-sided copper, tin-plated and standard footprint.

[2] Device mounted on an FR4 PCB, single-sided copper, tin-plated, mounting pad for cathode 1 cm^2 .

[3] Soldering point of cathode tab.

7 Characteristics

Table 7. Characteristics

$T_j = 25\text{ °C}$ unless otherwise specified.

Symbol	Parameter	Conditions	Min	Typ	Max	Unit
V_F	forward voltage	$I_F = 10\text{ mA}$	[1] -	-	0.9	V
V_F	forward voltage	$I_F = 100\text{ mA}$	[1] -	-	1.1	V

[1] Pulse test: $t_p \leq 300\text{ }\mu\text{s}$; $\delta \leq 0.02$.

Table 8. Characteristics per type; PDZ2.4BGW to PDZ36BGW

 $T_j = 25\text{ °C}$ unless otherwise specified.

PDZx BGW	Sel	Working voltage V_Z (V); $I_Z = 5\text{ mA}$		Maximum differential resistance r_{dif} (Ω)		Reverse current I_R (μA)		Temperature coefficient S_Z (mV/K); $I_Z = 5\text{ mA}$	Diode capacitance C_d (pF) ^[1]	Non- repetitive peak reverse current I_{ZSM} (A) ^[2]
		Min	Max	$I_Z = 0.5\text{ mA}$	$I_Z = 5\text{ mA}$	Max	V_R (V)	Typ	Max	Max
2.4	B	2.43	2.63	1000	100	50	1.0	-1.6	450	8.0
2.7	B	2.69	2.91	1000	100	20	1.0	-2.0	440	8.0
3.0	B	2.85	3.07	1000	95	10	1.0	-2.1	425	8.0
3.3	B	3.32	3.53	1000	95	5	1.0	-2.4	410	8.0
3.6	B	3.60	3.85	500 @ 1 mA	90	5	1.0	-2.4	390	8.0
3.9	B	3.89	4.16	500 @ 1 mA	90	3	1.0	-2.5	370	8.0
4.3	B	4.17	4.48	600 @ 1 mA	90	3	1.0	-2.5	350	8.0
4.7	B	4.55	4.75	600 @ 1 mA	90	2	1.0	-1.4	325	8.0
5.1	B	4.96	5.20	250	60	2	1.5	0.3	300	5.5
5.6	B	5.48	5.73	100	50	1	2.5	1.9	275	5.5
6.2	B	6.06	6.33	80	50	0.5	3.0	2.7	250	5.5
6.8	B	6.65	6.93	60	40	0.5	3.5	3.4	215	5.5
7.5	B	7.28	7.60	60	10	0.5	4.0	4.0	170	3.5
8.2	B	8.02	8.36	60	10	0.5	5.0	4.6	150	3.5
9.1	B	8.85	9.23	60	10	0.5	6.0	5.5	120	3.5
10	B	9.77	10.21	60	10	0.1	7.0	6.4	110	3.5
11	B	10.78	11.22	60	10	0.1	8.0	7.4	108	3.0
12	B	11.74	12.24	80	10	0.1	9.0	8.4	105	3.0
13	B	12.91	13.49	80	10	0.1	10.0	9.4	103	2.5
15	B	14.34	14.98	80	15	0.05	11.0	11.4	99	2.0
16	B	15.85	16.51	80	20	0.05	12.0	12.4	97	1.5
18	B	17.56	18.35	80	20	0.05	13.0	14.4	93	1.5
20	B	19.52	20.39	100	20	0.05	15.0	16.4	88	1.5
22	B	21.54	22.47	100	25	0.05	17.0	18.4	84	1.3
24	B	23.72	24.78	120	30	0.05	19.0	20.4	80	1.3

PDZx BGW	Sel	Working voltage V_Z (V); $I_Z = 5$ mA		Maximum differential resistance r_{dif} (Ω)		Reverse current I_R (μ A)		Temperature coefficient S_Z (mV/K); $I_Z = 5$ mA	Diode capacitance C_d (pF) ^[1]	Non-repetitive peak reverse current I_{ZSM} (A) ^[2]
		Min	Max	$I_Z = 0.5$ mA	$I_Z = 5$ mA	Max	V_R (V)	Typ	Max	Max
27	B	26.19	27.53	150	40	0.05	21.0	23.4	73	1.0
30	B	29.19	30.69	200	40	0.05	23.0	26.6	66	1.0
33	B	32.15	33.79	250	40	0.05	25.0	29.7	60	0.9
36	B	35.07	36.87	300	60	0.05	27.0	33.0	59	0.8

[1] $f = 1$ MHz; $V_R = 0$ V.

[2] $t_p = 100$ μ s; $T_{amb} = 25$ °C.

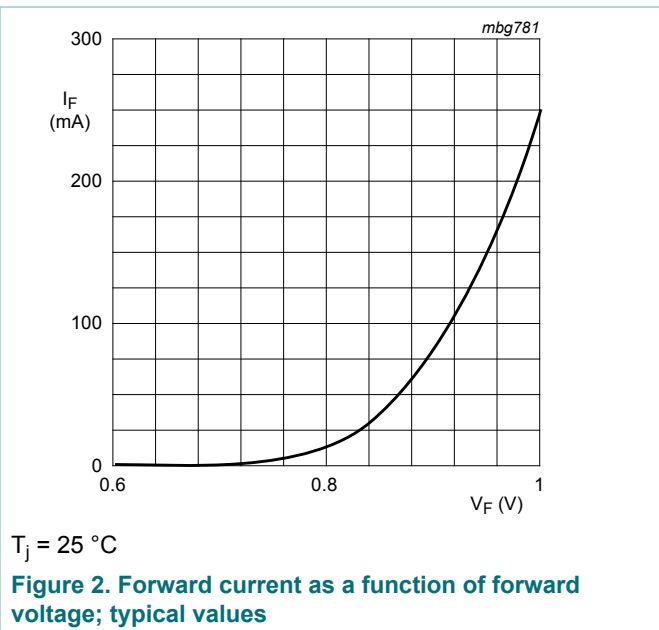
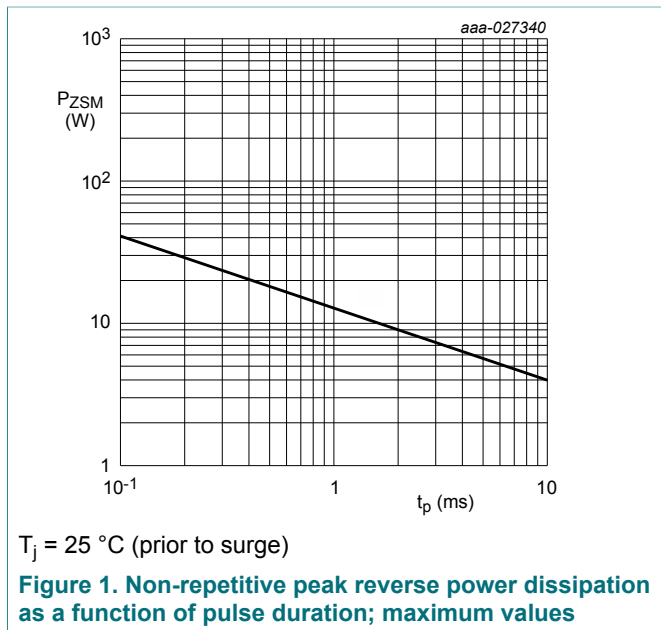

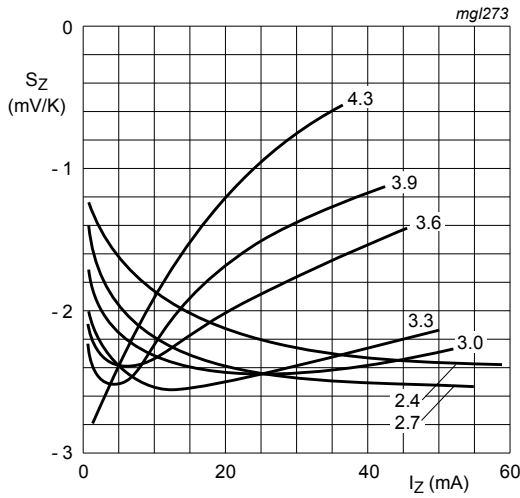

PDZ2.4BGW to PDZ4.3BGW
 $T_j = 25\text{ }^\circ\text{C}$ to $150\text{ }^\circ\text{C}$

Figure 3. Temperature coefficient as a function of working current; typical values

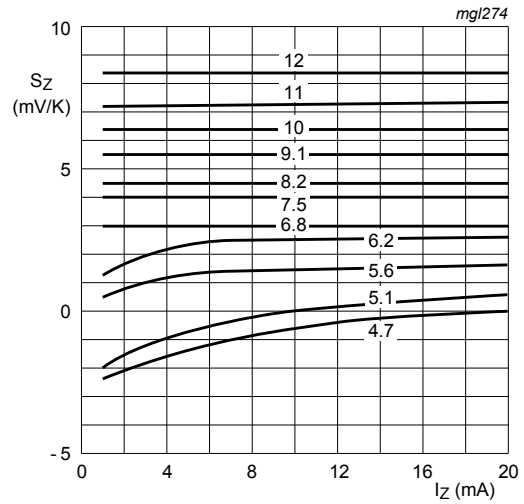

PDZ4.7BGW to PDZ12BGW
 $T_j = 25\text{ }^\circ\text{C}$ to $150\text{ }^\circ\text{C}$

Figure 4. Temperature coefficient as a function of working current; typical values

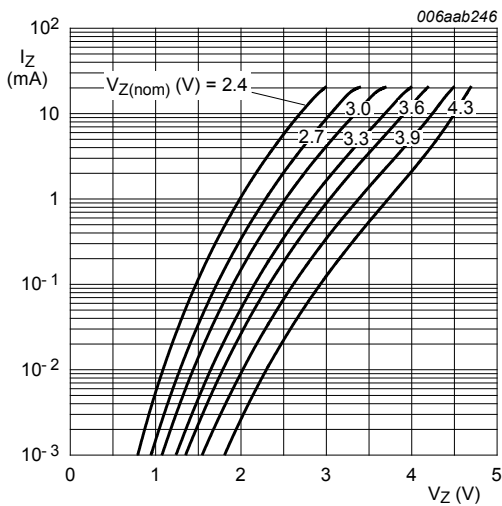

PDZ2.4BGW to PDZ4.3BGW
 $T_j = 25\text{ }^\circ\text{C}$

Figure 5. Working current as a function of working voltage; typical values

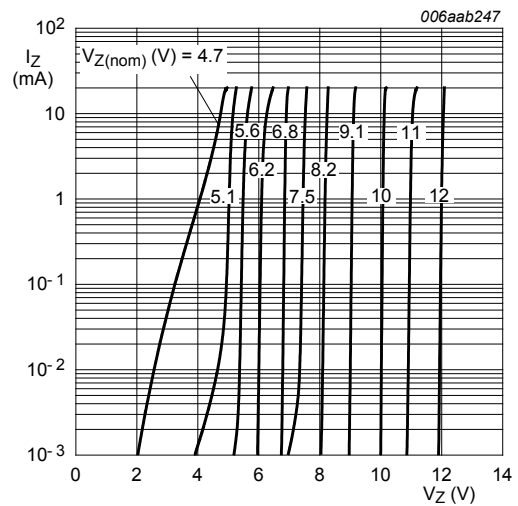

PDZ4.7BGW to PDZ12BGW
 $T_j = 25\text{ }^\circ\text{C}$

Figure 6. Working current as a function of working voltage; typical values

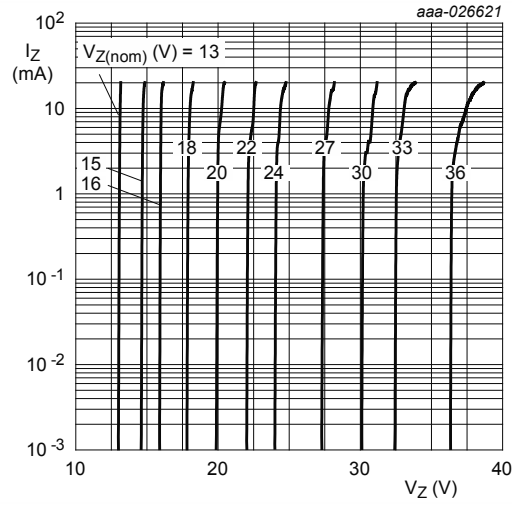

PDZ13BGW to PDZ36BGW

T_j = 25 °C

Figure 7. Working current as a function of working voltage; typical values

8 Test information

8.1 Quality information

This product has been qualified in accordance with the Automotive Electronics Council (AEC) standard Q101 - Stress test qualification for discrete semiconductors, and is suitable for use in automotive applications.

9 Package outline

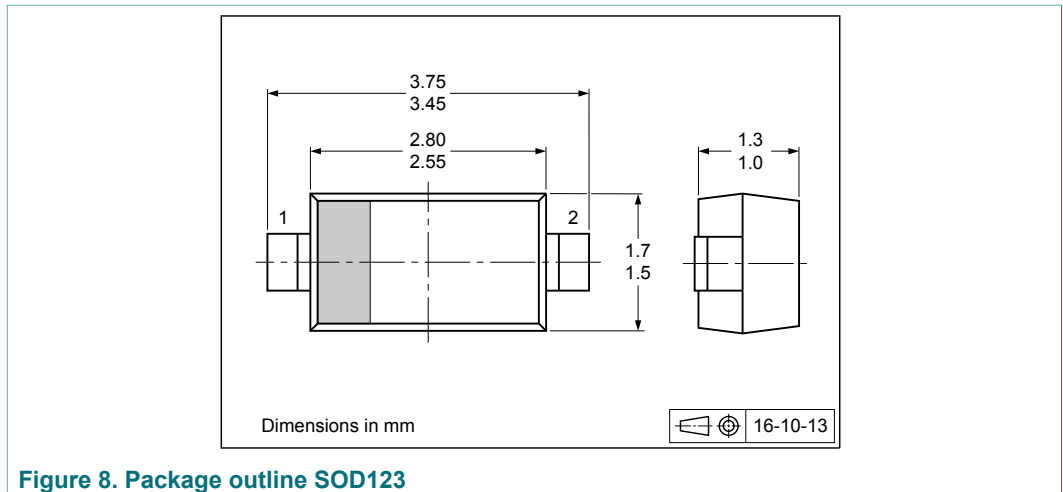
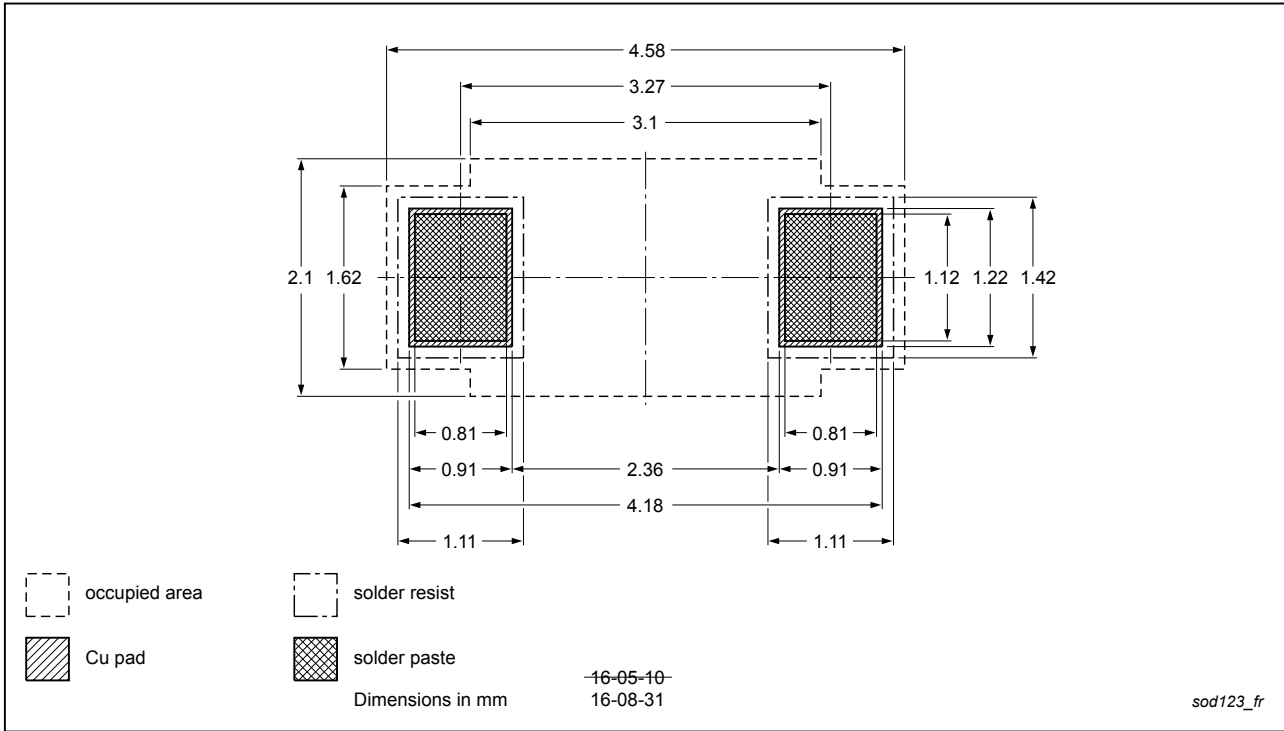

Figure 8. Package outline SOD123

10 Soldering

SOD123



Reflow soldering is the only recommended soldering method.
Dimensions in mm.

Figure 9. Reflow soldering footprint SOD123

11 Revision history

Table 9. Revision history

Document ID	Release date	Data sheet status	Change notice	Supersedes
PDZ-GW_SER v.1	20170904	Product data sheet	-	-

12 Legal information

12.1 Data sheet status

Document status ^{[1][2]}	Product status ^[3]	Definition
Objective [short] data sheet	Development	This document contains data from the objective specification for product development.
Preliminary [short] data sheet	Qualification	This document contains data from the preliminary specification.
Product [short] data sheet	Production	This document contains the product specification.

[1] Please consult the most recently issued document before initiating or completing a design.

[2] The term 'short data sheet' is explained in section "Definitions".

[3] The product status of device(s) described in this document may have changed since this document was published and may differ in case of multiple devices. The latest product status information is available on the Internet at URL <http://www.nexperia.com>.

12.2 Definitions

Draft — The document is a draft version only. The content is still under internal review and subject to formal approval, which may result in modifications or additions. Nexperia does not give any representations or warranties as to the accuracy or completeness of information included herein and shall have no liability for the consequences of use of such information.

Short data sheet — A short data sheet is an extract from a full data sheet with the same product type number(s) and title. A short data sheet is intended for quick reference only and should not be relied upon to contain detailed and full information. For detailed and full information see the relevant full data sheet, which is available on request via the local Nexperia sales office. In case of any inconsistency or conflict with the short data sheet, the full data sheet shall prevail.

Product specification — The information and data provided in a Product data sheet shall define the specification of the product as agreed between Nexperia and its customer, unless Nexperia and customer have explicitly agreed otherwise in writing. In no event however, shall an agreement be valid in which the Nexperia product is deemed to offer functions and qualities beyond those described in the Product data sheet.

12.3 Disclaimers

Limited warranty and liability — Information in this document is believed to be accurate and reliable. However, Nexperia does not give any representations or warranties, expressed or implied, as to the accuracy or completeness of such information and shall have no liability for the consequences of use of such information. Nexperia takes no responsibility for the content in this document if provided by an information source outside of Nexperia. In no event shall Nexperia be liable for any indirect, incidental, punitive, special or consequential damages (including - without limitation - lost profits, lost savings, business interruption, costs related to the removal or replacement of any products or rework charges) whether or not such damages are based on tort (including negligence), warranty, breach of contract or any other legal theory. Notwithstanding any damages that customer might incur for any reason whatsoever, Nexperia's aggregate and cumulative liability towards customer for the products described herein shall be limited in accordance with the Terms and conditions of commercial sale of Nexperia.

Right to make changes — Nexperia reserves the right to make changes to information published in this document, including without limitation specifications and product descriptions, at any time and without notice. This document supersedes and replaces all information supplied prior to the publication hereof.

Suitability for use — Nexperia products are not designed, authorized or warranted to be suitable for use in life support, life-critical or safety-critical

systems or equipment, nor in applications where failure or malfunction of an Nexperia product can reasonably be expected to result in personal injury, death or severe property or environmental damage. Nexperia and its suppliers accept no liability for inclusion and/or use of Nexperia products in such equipment or applications and therefore such inclusion and/or use is at the customer's own risk.

Applications — Applications that are described herein for any of these products are for illustrative purposes only. Nexperia makes no representation or warranty that such applications will be suitable for the specified use without further testing or modification. Customers are responsible for the design and operation of their applications and products using Nexperia products, and Nexperia accepts no liability for any assistance with applications or customer product design. It is customer's sole responsibility to determine whether the Nexperia product is suitable and fit for the customer's applications and products planned, as well as for the planned application and use of customer's third party customer(s). Customers should provide appropriate design and operating safeguards to minimize the risks associated with their applications and products. Nexperia does not accept any liability related to any default, damage, costs or problem which is based on any weakness or default in the customer's applications or products, or the application or use by customer's third party customer(s). Customer is responsible for doing all necessary testing for the customer's applications and products using Nexperia products in order to avoid a default of the applications and the products or of the application or use by customer's third party customer(s). Nexperia does not accept any liability in this respect.

Limiting values — Stress above one or more limiting values (as defined in the Absolute Maximum Ratings System of IEC 60134) will cause permanent damage to the device. Limiting values are stress ratings only and (proper) operation of the device at these or any other conditions above those given in the Recommended operating conditions section (if present) or the Characteristics sections of this document is not warranted. Constant or repeated exposure to limiting values will permanently and irreversibly affect the quality and reliability of the device.

Terms and conditions of commercial sale — Nexperia products are sold subject to the general terms and conditions of commercial sale, as published at <http://www.nexperia.com/profile/terms>, unless otherwise agreed in a valid written individual agreement. In case an individual agreement is concluded only the terms and conditions of the respective agreement shall apply. Nexperia hereby expressly objects to applying the customer's general terms and conditions with regard to the purchase of Nexperia products by customer.

No offer to sell or license — Nothing in this document may be interpreted or construed as an offer to sell products that is open for acceptance or the grant, conveyance or implication of any license under any copyrights, patents or other industrial or intellectual property rights.

Export control — This document as well as the item(s) described herein may be subject to export control regulations. Export might require a prior authorization from competent authorities.

Non-automotive qualified products — Unless this data sheet expressly states that this specific Nexperia product is automotive qualified, the product is not suitable for automotive use. It is neither qualified nor tested in accordance with automotive testing or application requirements. Nexperia accepts no liability for inclusion and/or use of non-automotive qualified products in automotive equipment or applications. In the event that customer uses the product for design-in and use in automotive applications to automotive specifications and standards, customer (a) shall use the product without Nexperia's warranty of the product for such automotive applications, use and specifications, and (b) whenever customer uses the product for automotive applications beyond Nexperia's specifications such use shall be solely at customer's own risk, and (c) customer fully indemnifies Nexperia for any liability, damages or failed product claims resulting from customer

design and use of the product for automotive applications beyond Nexperia's standard warranty and Nexperia's product specifications.

Translations — A non-English (translated) version of a document is for reference only. The English version shall prevail in case of any discrepancy between the translated and English versions.

12.4 Trademarks

Notice: All referenced brands, product names, service names and trademarks are the property of their respective owners.

Contents

1	Product profile	1
1.1	General description	1
1.2	Features and benefits	1
1.3	Applications	1
1.4	Quick reference data	1
2	Pinning information	2
3	Ordering information	2
4	Marking	2
5	Limiting values	3
6	Thermal characteristics	3
7	Characteristics	3
8	Test information	7
8.1	Quality information	7
9	Package outline	7
10	Soldering	8
11	Revision history	9
12	Legal information	10

Please be aware that important notices concerning this document and the product(s) described herein, have been included in section 'Legal information'.

© Nexperia B.V. 2017.

All rights reserved.

For more information, please visit: <http://www.nexperia.com>

For sales office addresses, please send an email to: salesaddresses@nexperia.com

Date of release: 4 September 2017
Document identifier: PDZ-GW_SER

Looking for pricing, stock, or lifecycle information?

Click below to explore more details on WIN SOURCE:

-  [View PDZ18BGWJ on WIN SOURCE](#)
-  [Nexperia USA Inc. Information](#)

Optimize Your Supply Chain with WIN SOURCE Solutions

-  Global Sourcing Solution
-  Obsolete Management
-  Cost Control Management
-  Shortage Management
-  Alternative Solution
-  Excess Inventory Management