



# THE DATASHEET OF PAM8009KGR





# New Product Announcement

---

## PAM8009

## 3W Stereo Class-D Audio Amplifier and Class-AB Headphone Driver

The PAM8009 is a highly integrated 3W Class-D audio power amplifier for driving bridged-tied (BTL) stereo speakers and includes a stereo Single ended (SE) headphone amplifier.

Packaged in two power efficient packages, the PAM8009 provides excellent audio performance and numerous features to provide complete system flexibility.

Advanced DC volume control minimizes external components required and allows precise volume control with 64 steps over the range of +20dB to -60dB. Mute and standby modes are provided to reduce noise or to minimize power.

The Auto Gain Control (AGC) function allows the PAM8009 to maximize the output power whilst protecting the speakers.



### The Diodes' Advantage

- **3W Stereo Class-D with built-in Head Phone Driver**  
Provides a reliable, high audio performance and integrated solution for multiple applications
- **Full Audio Control allows the Audio amp to have full system control**
  - 64 Step volume control over the range of +20dB to -60dB
  - Mute disables the outputs
  - Standby functions puts the PAM8009 asleep minimizing power consumption
- **Enhanced System Protection**
  - Integrated Auto Gain Control function for speaker protection
  - Integrated power limit function (for output power limit)
  - Thermal and Over-Current protection with auto-recovery
  - Under voltage shut down ensures the amplifier is always fully functional

### Applications

- LCD monitor / TV
- Projector
- Computing
- All-in One Computers
- Game machines
- DVD player



# New Product Announcement

## PAM8009

### Typical Application Schematic

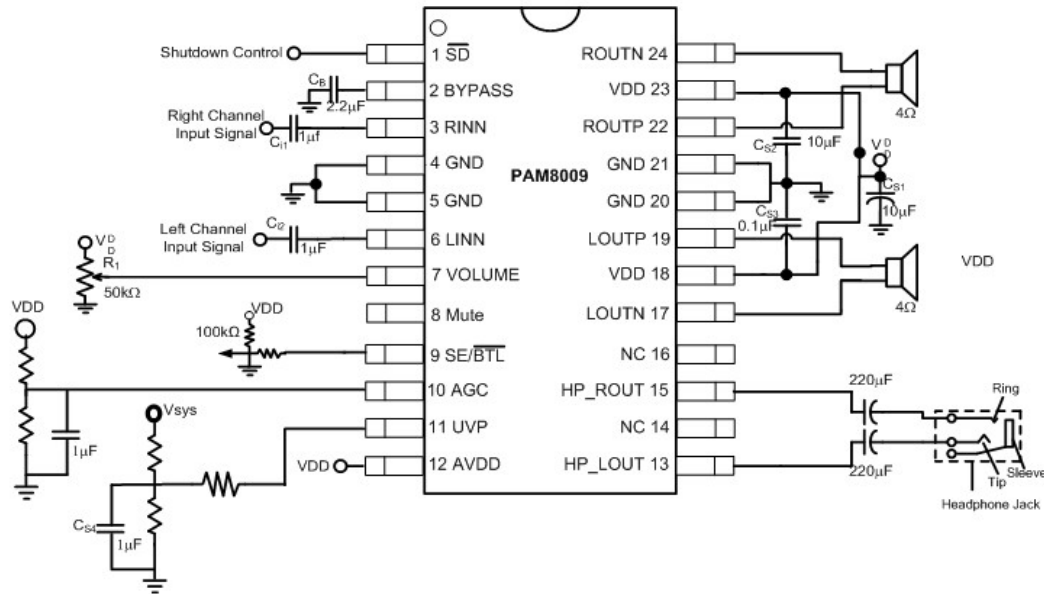

### Product Portfolio

Part Number	Min. Input Voltage	Max. Input Voltage	Efficiency (%)	Volume	SNR(dB)	PSRR(dB)	Package
PAM8009DHR	2.8	5.5	90	DC	83	-61	SOP-24
PAM8009KGR	2.8	5.5	90	DC	83	-61	U-DFN4040-20

### Ordering Information

Device	Packaging	Package Marking info.	Reel Size	Tape Width	Quantity
PAM8009DHR	SOP-24	PAM8009 XXXYWWLL	13"	12mm	1000
PAM8009KGR	U-QFN4040-20	PAM8009 XXXYW	7"	8 mm	3000

### Further Information:







Audio Portfolio page: [http://diodes.com/catalog/audio\\_95/](http://diodes.com/catalog/audio_95/)

## Looking for pricing, stock, or lifecycle information?

Click below to explore more details on WIN SOURCE:

-  [View PAM8009KGR on WIN SOURCE](#)
-  [Diodes Incorporated Information](#)

## Optimize Your Supply Chain with WIN SOURCE Solutions

-  Global Sourcing Solution
-  Obsolete Management
-  Cost Control Management
-  Shortage Management
-  Alternative Solution
-  Excess Inventory Management